

Trench gate field-stop IGBT, M series 650 V, 10 A low-loss in TO-220 package

Datasheet - production data

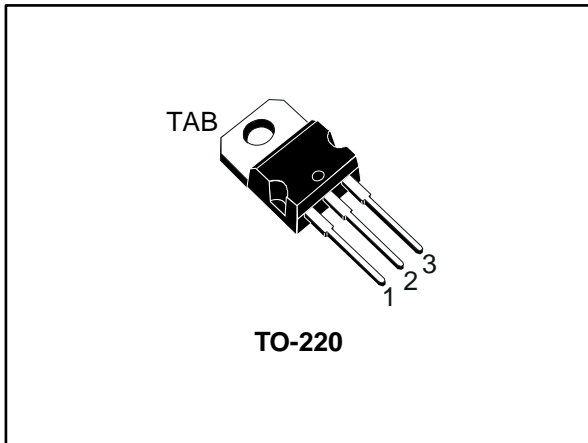
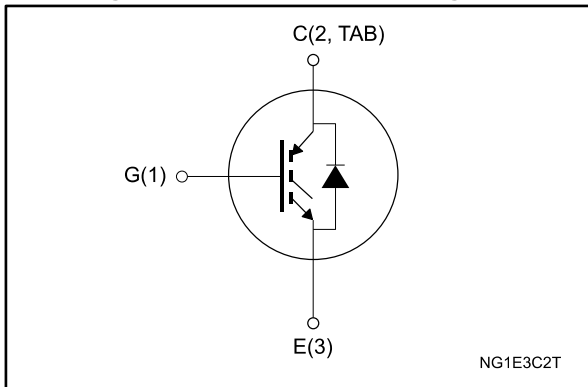

Figure 1: Internal schematic diagram



Features

- 6 μ s of short-circuit withstand time
- $V_{CE(sat)} = 1.55$ V (typ.) @ $I_C = 10$ A
- Tight parameter distribution
- Safer paralleling
- Positive $V_{CE(sat)}$ temperature coefficient
- Low thermal resistance
- Soft and very fast recovery antiparallel diode
- Maximum junction temperature: $T_J = 175$ °C

Applications

- Motor control
- UPS
- PFC
- General purpose inverter

Description

This device is an IGBT developed using an advanced proprietary trench gate field-stop structure. The device is part of the M series IGBTs, which represent an optimal balance between inverter system performance and efficiency where low-loss and short-circuit functionality are essential. Furthermore, the positive $V_{CE(sat)}$ temperature coefficient and tight parameter distribution result in safer paralleling operation.

Table 1: Device summary

Order code	Marking	Package	Packing
STGP10M65DF2	G10M65DF2	TO-220	Tube

Contents

1	Electrical ratings	3
2	Electrical characteristics	4
	2.1 Electrical characteristics (curves).....	6
3	Test circuits	12
4	Package information	13
	4.1 TO-220 type A package information.....	14
5	Revision history	16

1 Electrical ratings

Table 2: Absolute maximum ratings

Symbol	Parameter	Value	Unit
V_{CES}	Collector-emitter voltage ($V_{GE} = 0$ V)	650	V
I_C	Continuous collector current at $T_C = 25$ °C	20	A
	Continuous collector current at $T_C = 100$ °C	10	
$I_{CP}^{(1)}$	Pulsed collector current	40	A
V_{GE}	Gate-emitter voltage	± 20	V
I_F	Continuous forward current at $T_C = 25$ °C	20	A
	Continuous forward current at $T_C = 100$ °C	10	
$I_{FP}^{(1)}$	Pulsed forward current	40	A
P_{TOT}	Total dissipation at $T_C = 25$ °C	115	W
T_{STG}	Storage temperature range	- 55 to 150	°C
T_J	Operating junction temperature range	- 55 to 175	

Notes:

⁽¹⁾Pulse width limited by maximum junction temperature.

Table 3: Thermal data

Symbol	Parameter	Value	Unit
R_{thJC}	Thermal resistance junction-case IGBT	1.3	°C/W
R_{thJC}	Thermal resistance junction-case diode	2.08	
R_{thJA}	Thermal resistance junction-ambient	62.5	

2 Electrical characteristics

$T_C = 25\text{ °C}$ unless otherwise specified

Table 4: Static characteristics

Symbol	Parameter	Test conditions	Min.	Typ.	Max.	Unit
$V_{(BR)CES}$	Collector-emitter breakdown voltage	$V_{GE} = 0\text{ V}$, $I_C = 250\text{ }\mu\text{A}$	650			V
$V_{CE(sat)}$	Collector-emitter saturation voltage	$V_{GE} = 15\text{ V}$, $I_C = 10\text{ A}$		1.55	2.0	V
		$V_{GE} = 15\text{ V}$, $I_C = 10\text{ A}$, $T_J = 125\text{ °C}$		1.9		
		$V_{GE} = 15\text{ V}$, $I_C = 10\text{ A}$, $T_J = 175\text{ °C}$		2.1		
V_F	Forward on-voltage	$I_F = 10\text{ A}$		1.5	2.25	V
		$I_F = 10\text{ A}$, $T_J = 125\text{ °C}$		1.3		
		$I_F = 10\text{ A}$, $T_J = 175\text{ °C}$		1.2		
$V_{GE(th)}$	Gate threshold voltage	$V_{CE} = V_{GE}$, $I_C = 250\text{ }\mu\text{A}$	5	6	7	V
I_{CES}	Collector cut-off current	$V_{GE} = 0\text{ V}$, $V_{CE} = 650\text{ V}$			25	μA
I_{GES}	Gate-emitter leakage current	$V_{CE} = 0\text{ V}$, $V_{GE} = \pm 20\text{ V}$			± 250	μA

Table 5: Dynamic characteristics

Symbol	Parameter	Test conditions	Min.	Typ.	Max.	Unit
C_{ies}	Input capacitance	$V_{CE} = 25\text{ V}$, $f = 1\text{ MHz}$, $V_{GE} = 0\text{ V}$	-	840	-	pF
C_{oes}	Output capacitance		-	63	-	
C_{res}	Reverse transfer capacitance		-	16	-	
Q_g	Total gate charge	$V_{CC} = 520\text{ V}$, $I_C = 10\text{ A}$, $V_{GE} = 0\text{ to }15\text{ V}$ (see Figure 30 : "Gate charge test circuit")	-	28	-	nC
Q_{ge}	Gate-emitter charge		-	6	-	
Q_{gc}	Gate-collector charge		-	12	-	

Table 6: IGBT switching characteristics (inductive load)

Symbol	Parameter	Test conditions	Min.	Typ.	Max.	Unit
$t_{d(on)}$	Turn-on delay time	$V_{CE} = 400\text{ V}$, $I_C = 10\text{ A}$, $V_{GE} = 15\text{ V}$, $R_G = 22\ \Omega$ (see Figure 29: "Test circuit for inductive load switching")		19	-	ns
t_r	Current rise time			7.4	-	ns
$(di/dt)_{on}$	Turn-on current slope			1086	-	A/ μ s
$t_{d(off)}$	Turn-off-delay time			91	-	ns
t_f	Current fall time			92	-	ns
$E_{on}^{(1)}$	Turn-on switching energy			0.12	-	mJ
$E_{off}^{(2)}$	Turn-off switching energy			0.27	-	mJ
E_{ts}	Total switching energy			0.39	-	mJ
$t_{d(on)}$	Turn-on delay time	$V_{CE} = 400\text{ V}$, $I_C = 10\text{ A}$, $V_{GE} = 15\text{ V}$, $R_G = 22\ \Omega$, $T_J = 175\text{ }^\circ\text{C}$ (see Figure 29: "Test circuit for inductive load switching")		18	-	ns
t_r	Current rise time			9	-	ns
$(di/dt)_{on}$	Turn-on current slope			890	-	A/ μ s
$t_{d(off)}$	Turn-off-delay time			90	-	ns
t_f	Current fall time			170	-	ns
$E_{on}^{(1)}$	Turn-on switching energy			0.26	-	mJ
$E_{off}^{(2)}$	Turn-off switching energy			0.4	-	mJ
E_{ts}	Total switching energy			0.66	-	mJ
t_{sc}	Short-circuit withstand time	$V_{CC} \leq 400\text{ V}$, $V_{GE} = 13\text{ V}$, $T_{Jstart} = 150\text{ }^\circ\text{C}$	10		-	μ s
		$V_{CC} \leq 400\text{ V}$, $V_{GE} = 15\text{ V}$, $T_{Jstart} = 150\text{ }^\circ\text{C}$	6		-	μ s

Notes:

(1)Including the reverse recovery of the diode.

(2)Including the tail of the collector current.

Table 7: Diode switching characteristics (inductive load)

Symbol	Parameter	Test conditions	Min.	Typ.	Max.	Unit
t_{rr}	Reverse recovery time	$I_F = 10\text{ A}$, $V_R = 400\text{ V}$, $V_{GE} = 15\text{ V}$, $di/dt = 1000\text{ A}/\mu\text{s}$ (see Figure 29: "Test circuit for inductive load switching")	-	96	-	ns
Q_{rr}	Reverse recovery charge		-	373	-	nC
I_{rrm}	Reverse recovery current		-	13	-	A
dl_{rr}/dt	Peak rate of fall of reverse recovery current during t_b		-	661	-	A/ μ s
E_{rr}	Reverse recovery energy		-	52	-	μ J
t_{rr}	Reverse recovery time	$I_F = 10\text{ A}$, $V_R = 400\text{ V}$, $V_{GE} = 15\text{ V}$, $di/dt = 1000\text{ A}/\mu\text{s}$, $T_J = 175\text{ }^\circ\text{C}$ (see Figure 29: "Test circuit for inductive load switching")	-	201	-	ns
Q_{rr}	Reverse recovery charge		-	1352	-	nC
I_{rrm}	Reverse recovery current		-	19	-	A
dl_{rr}/dt	Peak rate of fall of reverse recovery current during t_b		-	405	-	A/ μ s
E_{rr}	Reverse recovery energy		-	150	-	μ J

2.1 Electrical characteristics (curves)

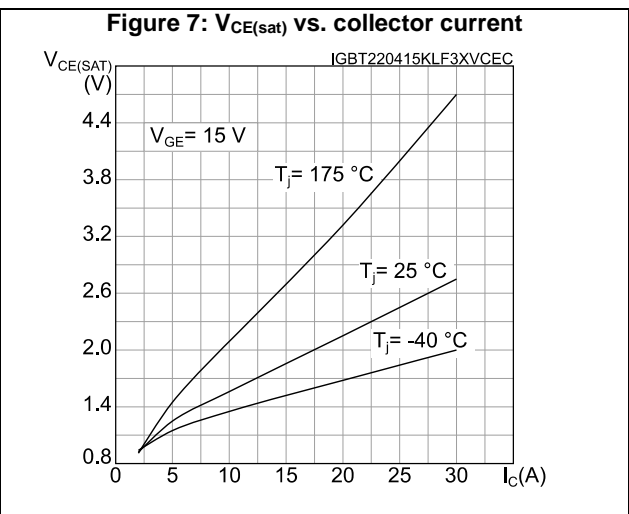
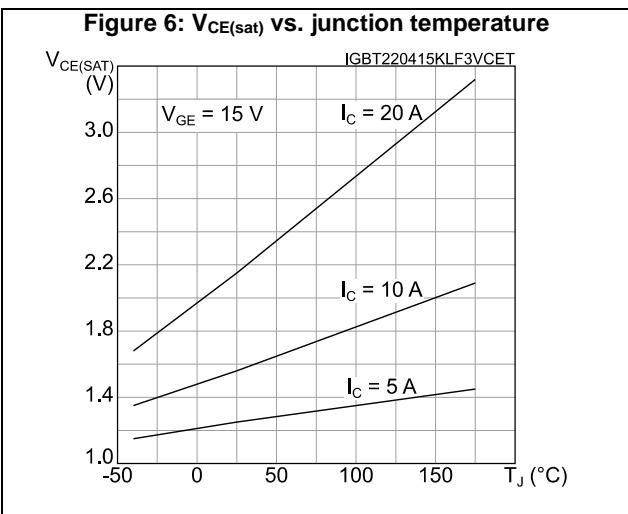
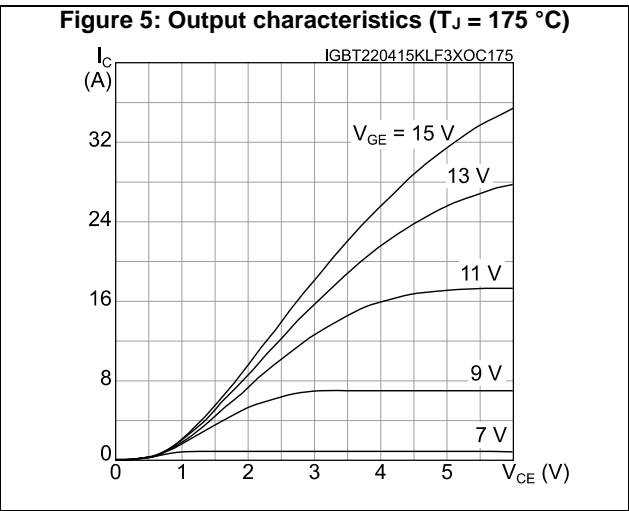
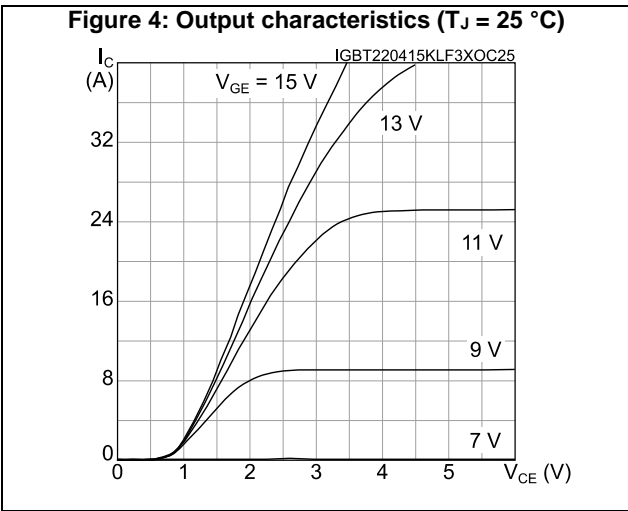
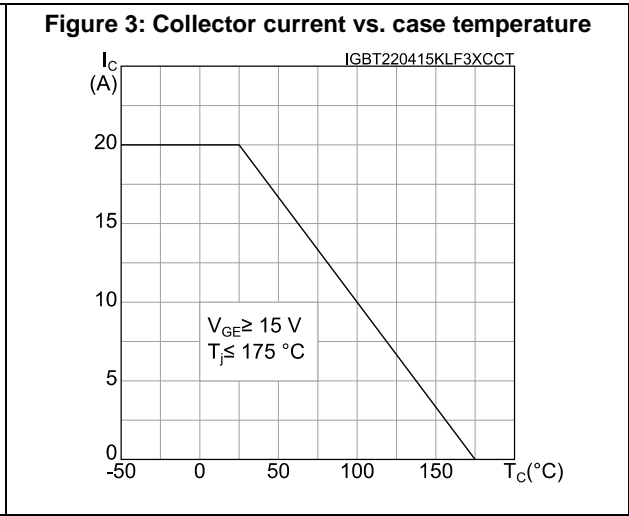
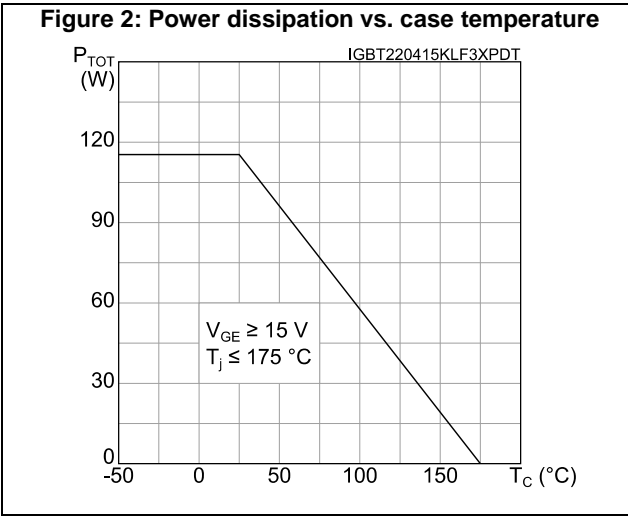

Figure 8: Collector current vs. switching frequency

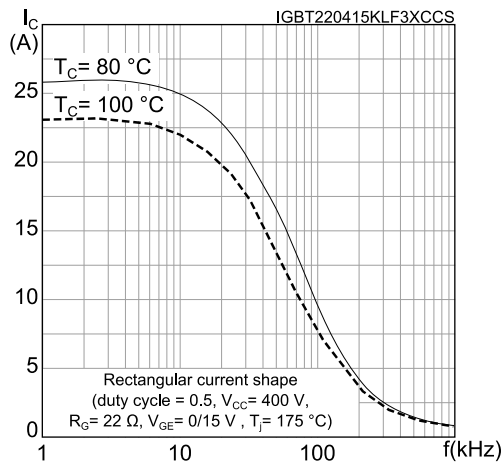

Figure 9: Forward bias safe operating area

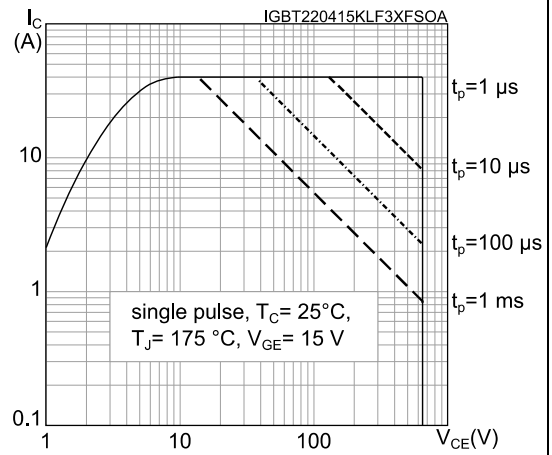

Figure 10: Transfer characteristics

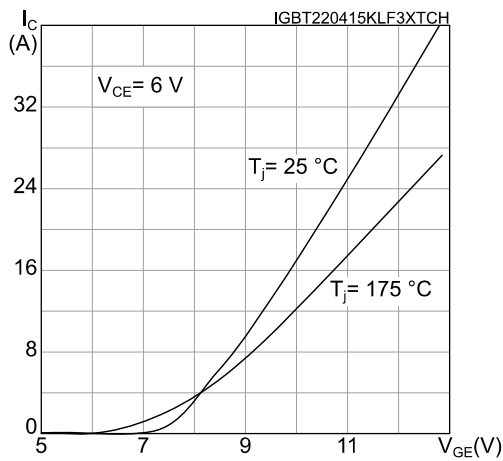

Figure 11: Diode V_F vs. forward current

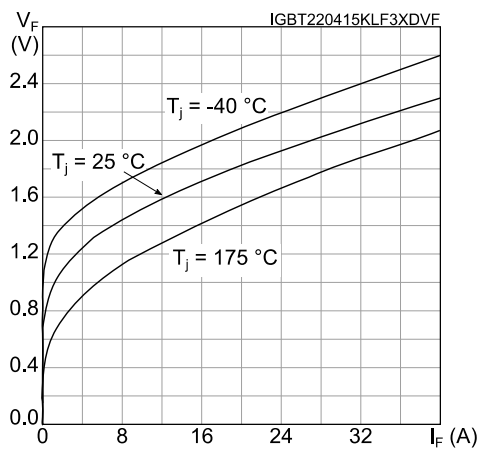

Figure 12: Normalized V_GE(th) vs. junction temperature

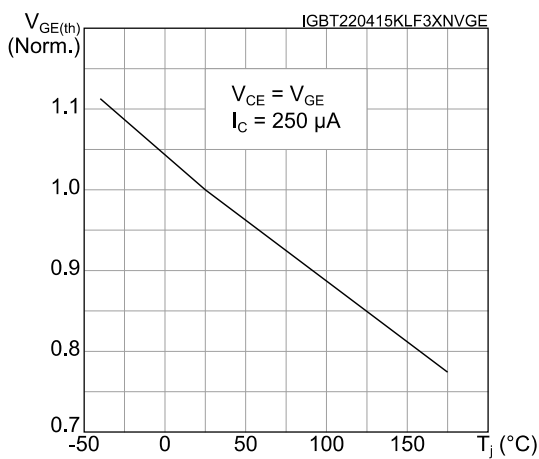
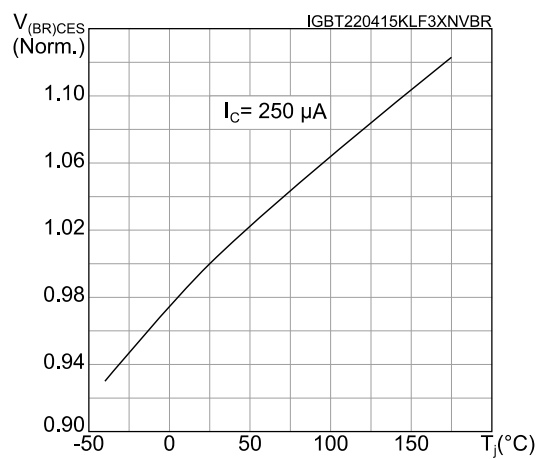
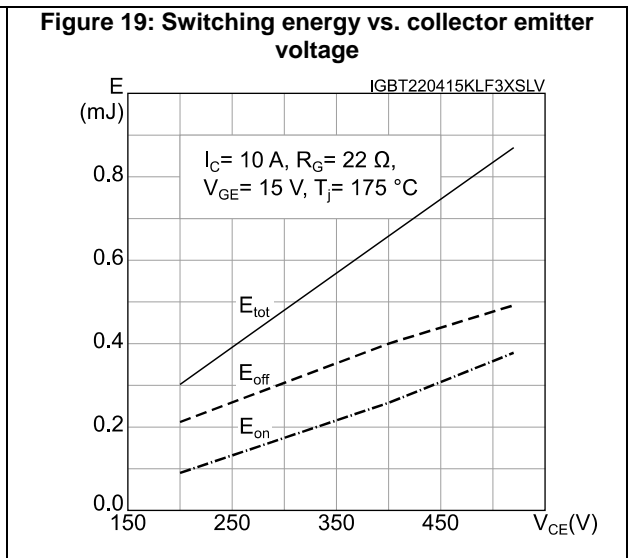
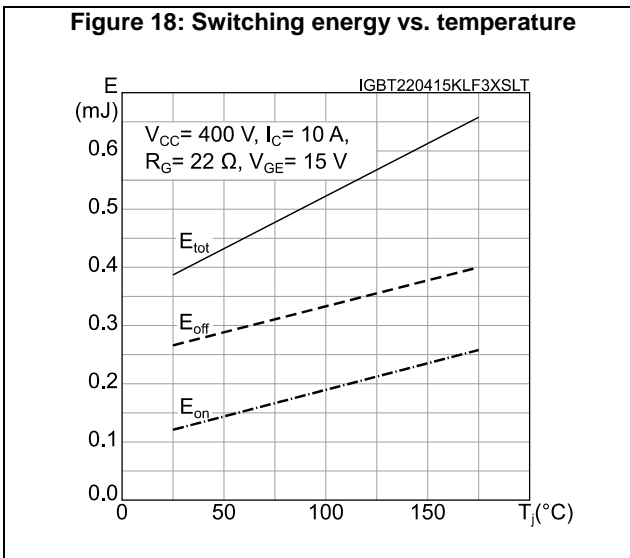
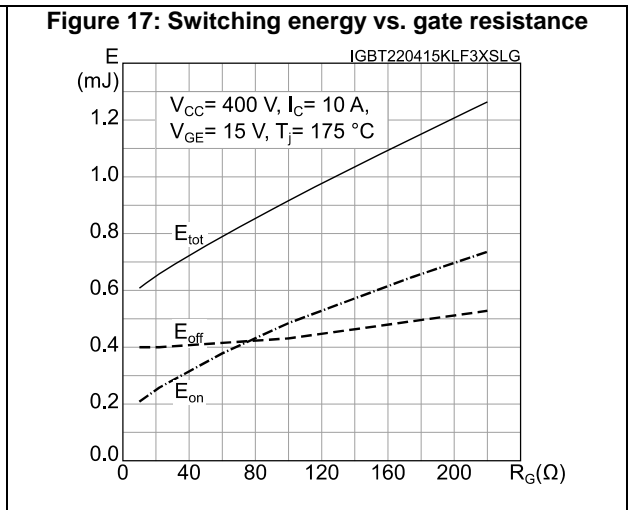
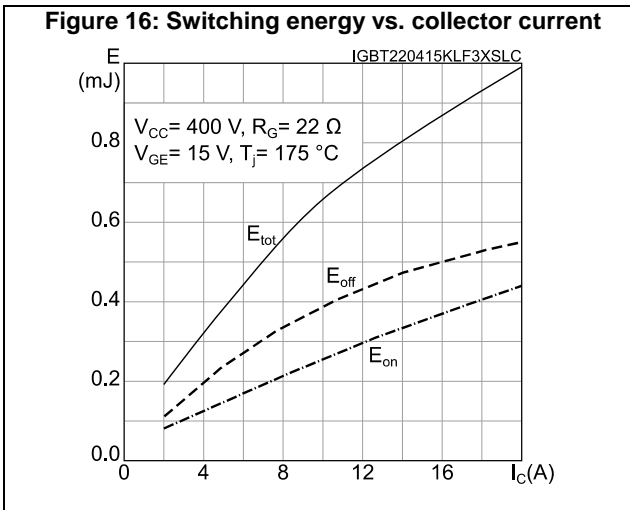
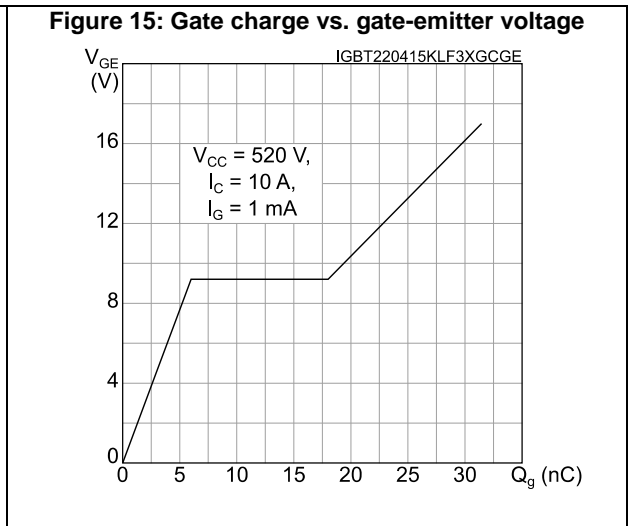
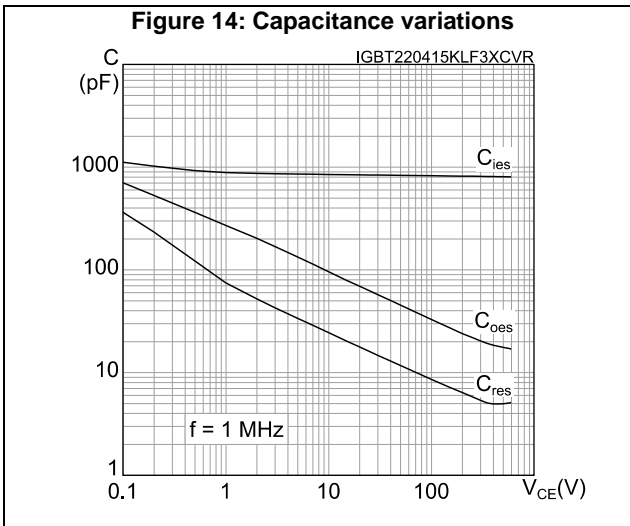

Figure 13: Normalized V_(BR)CES vs. junction temperature





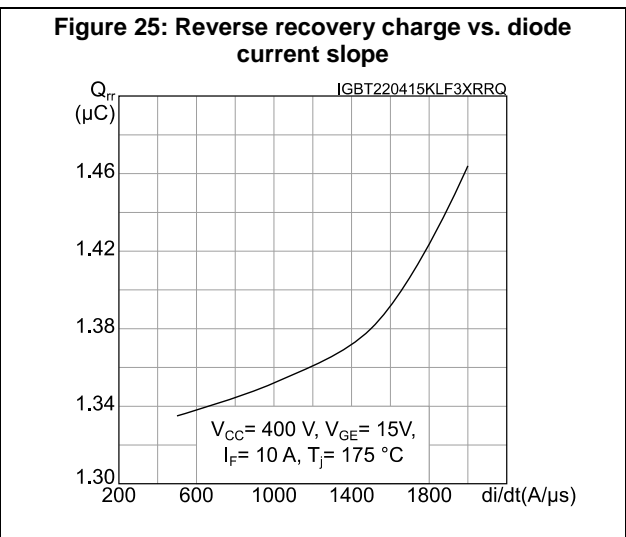
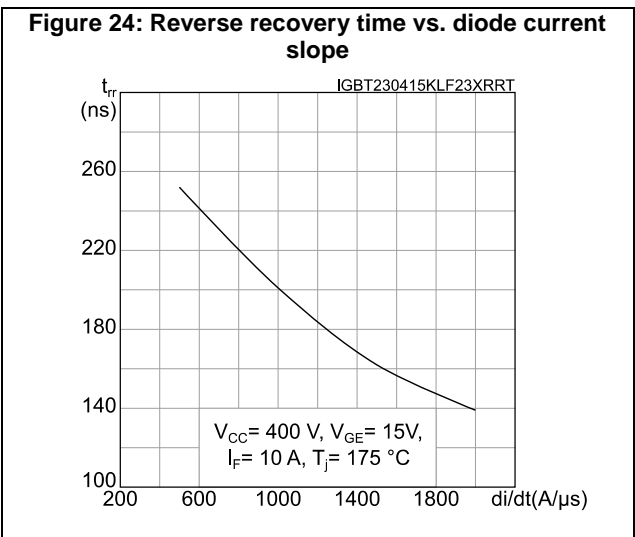
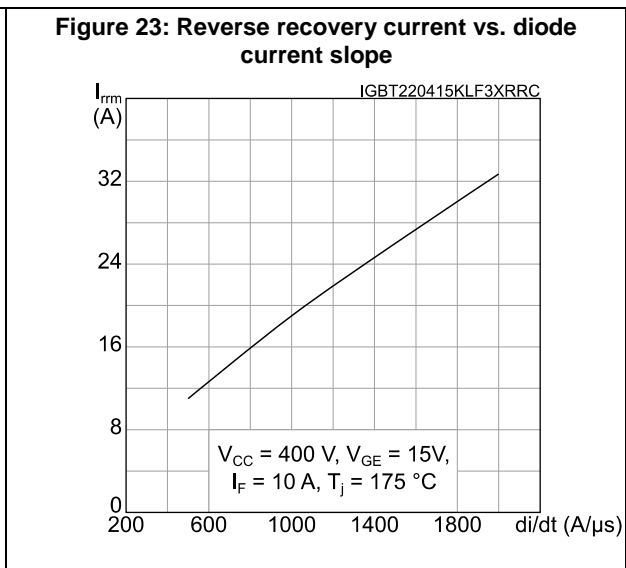
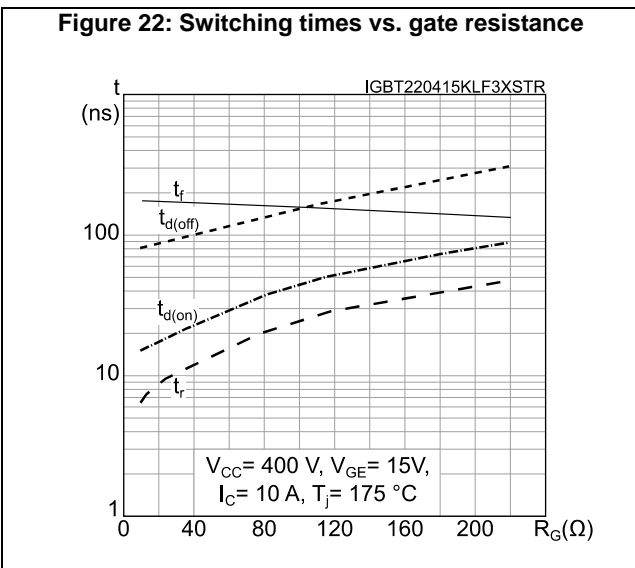
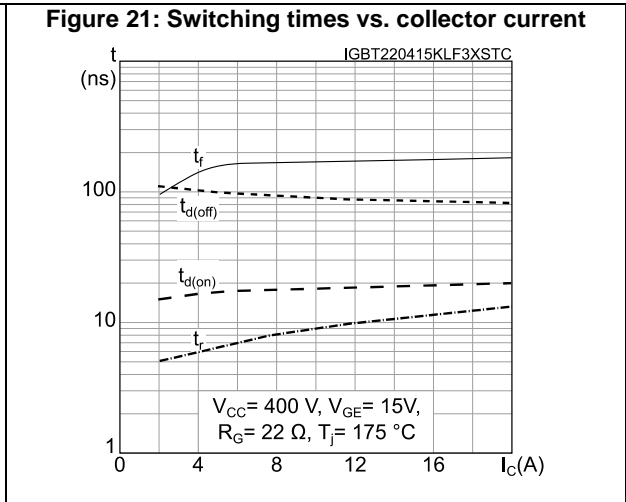
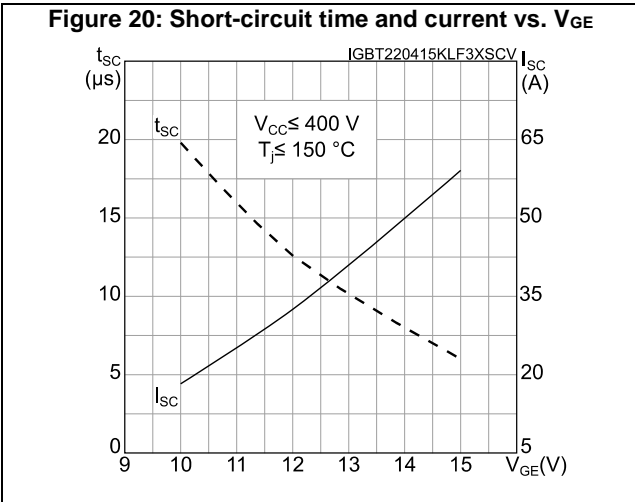

Figure 26: Reverse recovery energy vs. diode current slope

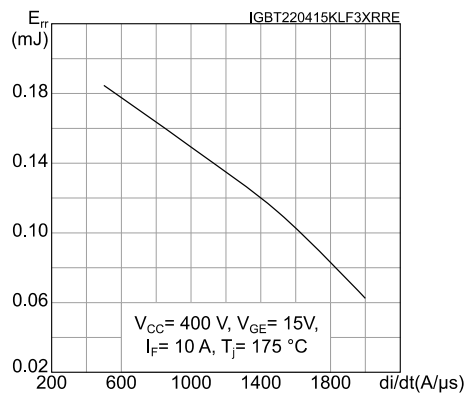

Figure 27: Thermal impedance for IGBT

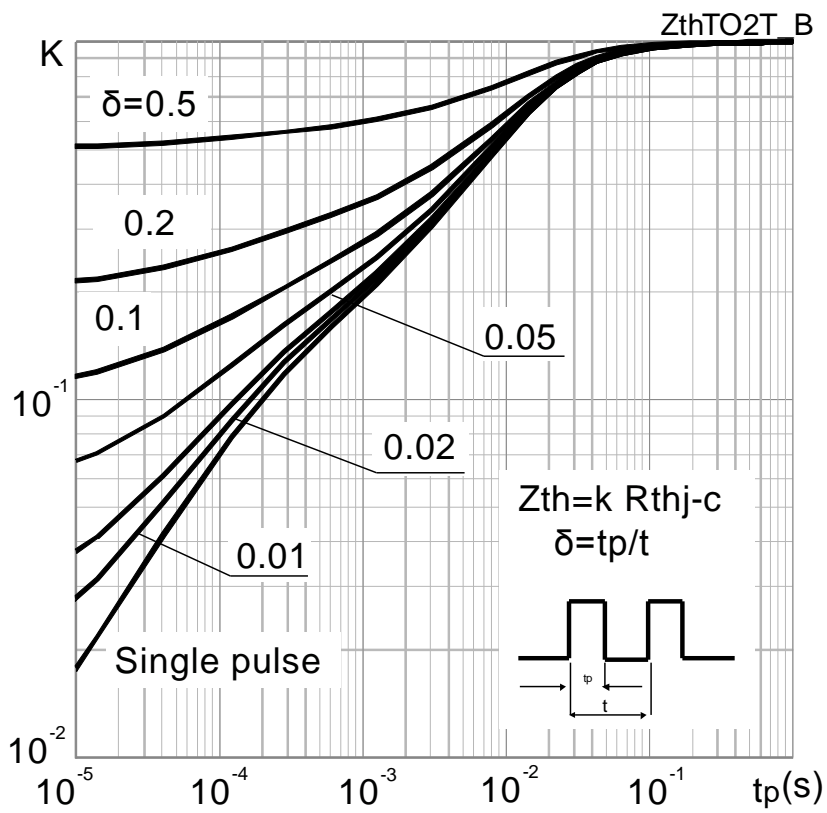
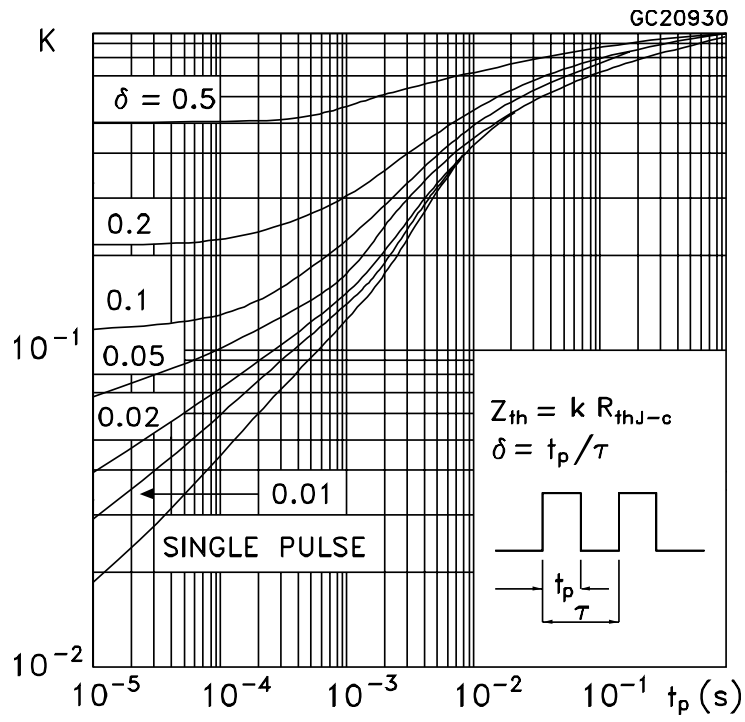
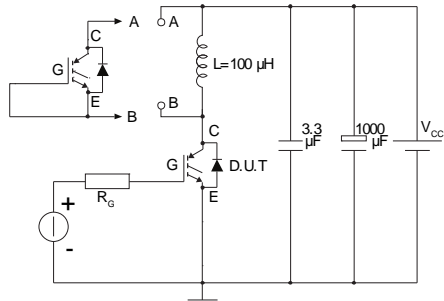

Figure 28: Thermal impedance for diode



3 Test circuits

Figure 29: Test circuit for inductive load switching



AM01504v1

Figure 30: Gate charge test circuit

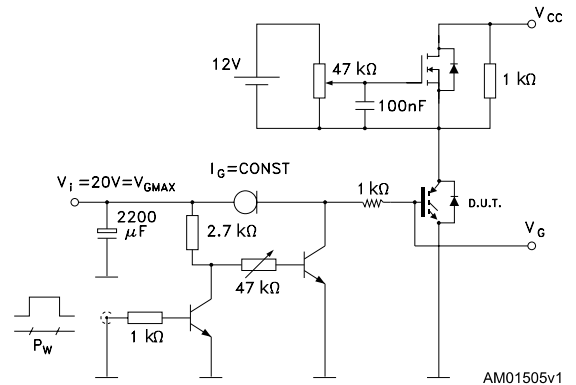

AM01505v1

Figure 31: Switching waveform

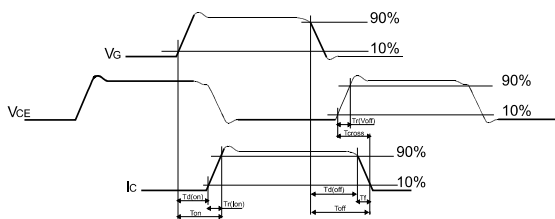

AM01506v1

Figure 32: Diode reverse recovery waveform

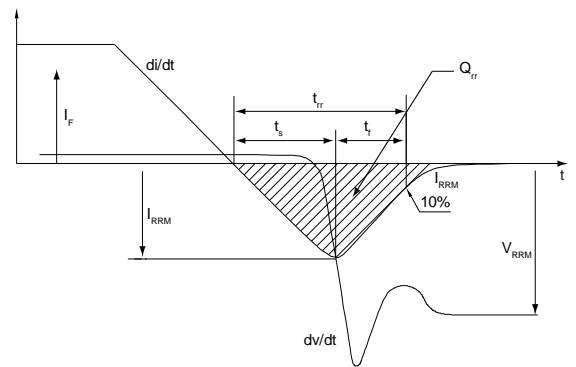

AM01507v1

4 Package information

In order to meet environmental requirements, ST offers these devices in different grades of ECOPACK® packages, depending on their level of environmental compliance. ECOPACK® specifications, grade definitions and product status are available at: www.st.com. ECOPACK® is an ST trademark.

4.1 TO-220 type A package information

Figure 33: TO-220 type A package outline

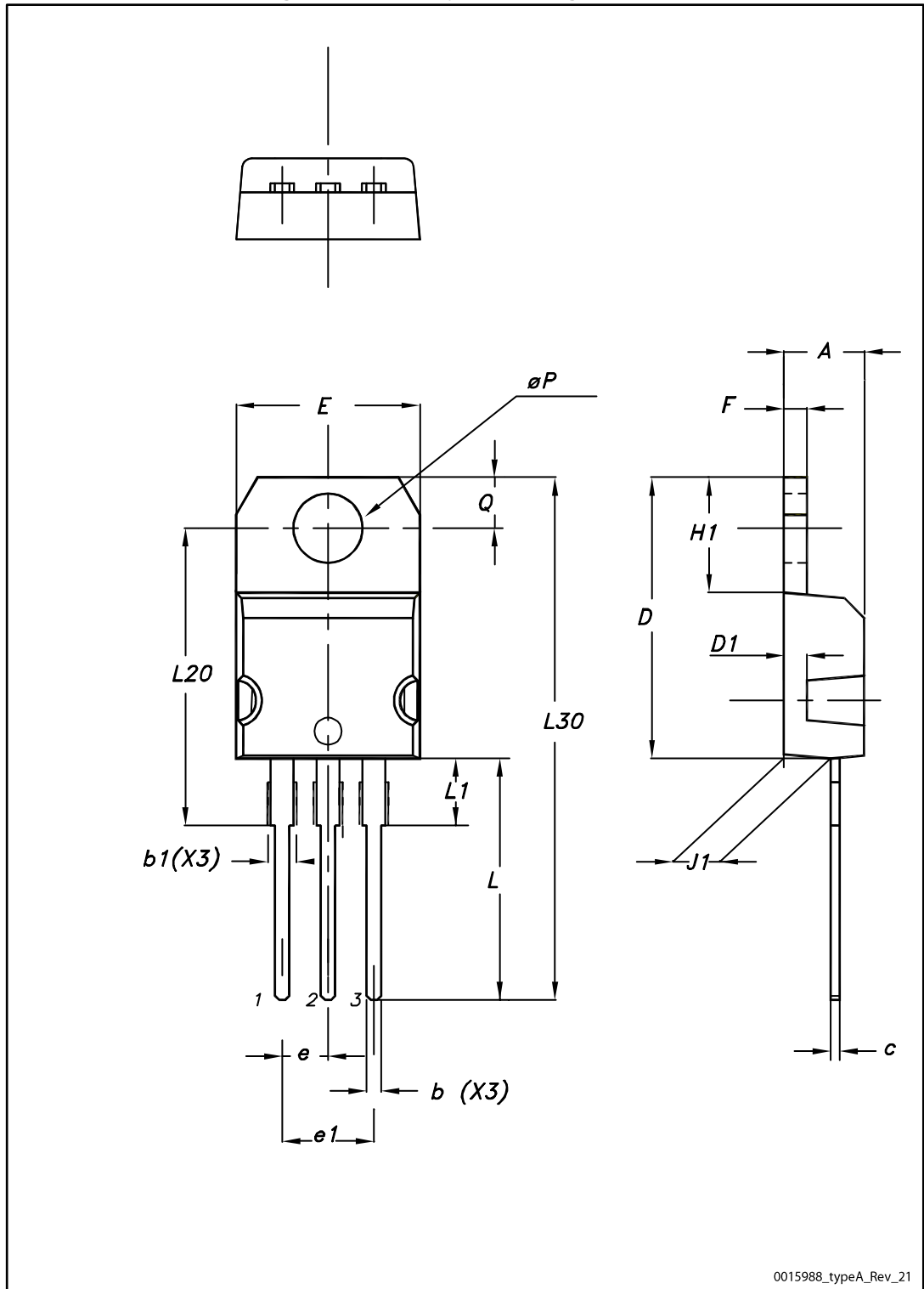

0015988_typeA_Rev_21

Table 8: TO-220 type A mechanical data

Dim.	mm		
	Min.	Typ.	Max.
A	4.40		4.60
b	0.61		0.88
b1	1.14		1.55
c	0.48		0.70
D	15.25		15.75
D1		1.27	
E	10.00		10.40
e	2.40		2.70
e1	4.95		5.15
F	1.23		1.32
H1	6.20		6.60
J1	2.40		2.72
L	13.00		14.00
L1	3.50		3.93
L20		16.40	
L30		28.90	
øP	3.75		3.85
Q	2.65		2.95

5 Revision history

Table 9: Document revision history

Date	Revision	Changes
10-Feb-2015	1	First release.
23-Apr-2015	2	Minor text edits throughout document Document status promoted to 'Production data' In Section 2 Electrical characteristics: - updated Table 4: Static characteristics - updated Table 5: Dynamic characteristics - updated Table 6: IGBT switching characteristics (inductive load) - updated Table 7: Diode switching characteristics (inductive load) Added Section 2.1 Electrical characteristics (curves)
31-Jul-2015	3	Updated Table 7: Diode switching characteristics (inductive load)
19-Oct-2015	4	Updated <i>Table 5: "Dynamic characteristics"</i> and <i>Table 6: "IGBT switching characteristics (inductive load)"</i> . Updated <i>Figure 8: "Collector current vs. switching frequency"</i> .
07-Apr-2017	5	Modified title, features and applications on cover page Modified <i>Table 4: "Static characteristics"</i> , <i>Table 6: "IGBT switching characteristics (inductive load)"</i> and <i>Table 7: "Diode switching characteristics (inductive load)"</i> Minor text changes.

IMPORTANT NOTICE – PLEASE READ CAREFULLY

STMicroelectronics NV and its subsidiaries ("ST") reserve the right to make changes, corrections, enhancements, modifications, and improvements to ST products and/or to this document at any time without notice. Purchasers should obtain the latest relevant information on ST products before placing orders. ST products are sold pursuant to ST's terms and conditions of sale in place at the time of order acknowledgement.

Purchasers are solely responsible for the choice, selection, and use of ST products and ST assumes no liability for application assistance or the design of Purchasers' products.

No license, express or implied, to any intellectual property right is granted by ST herein.

Resale of ST products with provisions different from the information set forth herein shall void any warranty granted by ST for such product.

ST and the ST logo are trademarks of ST. All other product or service names are the property of their respective owners.

Information in this document supersedes and replaces information previously supplied in any prior versions of this document.

© 2017 STMicroelectronics – All rights reserved



Стандарт Электрон Связь

Мы молодая и активно развивающаяся компания в области поставок электронных компонентов. Мы поставляем электронные компоненты отечественного и импортного производства напрямую от производителей и с крупнейших складов мира.

Благодаря сотрудничеству с мировыми поставщиками мы осуществляем комплексные и плановые поставки широчайшего спектра электронных компонентов.

Собственная эффективная логистика и склад в обеспечивает надежную поставку продукции в точно указанные сроки по всей России.

Мы осуществляем техническую поддержку нашим клиентам и предпродажную проверку качества продукции. На все поставляемые продукты мы предоставляем гарантию .

Осуществляем поставки продукции под контролем ВП МО РФ на предприятия военно-промышленного комплекса России , а также работаем в рамках 275 ФЗ с открытием отдельных счетов в уполномоченном банке. Система менеджмента качества компании соответствует требованиям ГОСТ ISO 9001.

Минимальные сроки поставки, гибкие цены, неограниченный ассортимент и индивидуальный подход к клиентам являются основой для выстраивания долгосрочного и эффективного сотрудничества с предприятиями радиоэлектронной промышленности, предприятиями ВПК и научно-исследовательскими институтами России.

С нами вы становитесь еще успешнее!

Наши контакты:

Телефон: +7 812 627 14 35

Электронная почта: sales@st-electron.ru

Адрес: 198099, Санкт-Петербург,
Промышленная ул, дом № 19, литера Н,
помещение 100-Н Офис 331