

NUMBER GS-12-584	TYPE PRODUCT SPECIFICATION		
TITLE PCI EXPRESS GENERATION II 1MM PITCH CONNECTOR		PAGE Page 1 of 9	REVISION D
		AUTHORIZED BY HONGTU ZHANG	DATE Mar/02/12
CLASSIFICATION UNRESTRICTED			

1.0 General:

This specification covers the functional and test requirements of PCI Express Generation II 1.00 mm pitch connector. The connector is designed to meet the connector requirements of PCI Express Card Electromechanical Specification (PCI-SIG document).

<u>Section</u>	<u>Title</u>	<u>Page</u>
1.0	General	1
2.0	Product description	1
3.0	Requirements	3
3.1	Mechanical characteristics	3
3.2	Electrical characteristics	4
3.3	Environmental characteristics	6
4.0	Product qualification provision	7
4.1	Inspection condition	7
4.2	Test plan	7
5.0	Packaging and handling	9

2.0 Product description:

2.1 Connector part number and profile:

FCI drawing P/N:

10082378-xxxxx (Press-Fit)

(10092852-xxxxx/10116975-xxxxx is not shown here)

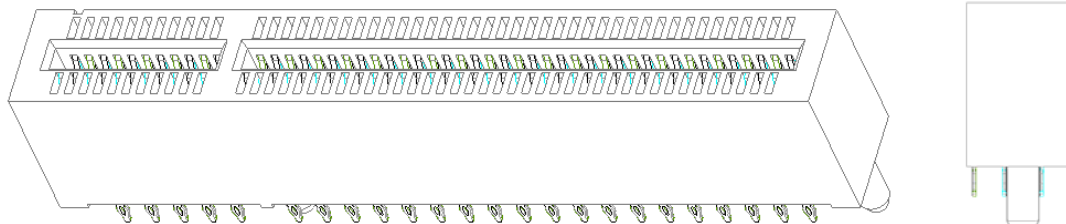

(Without Retention Ridge)

NUMBER GS-12-584	TYPE PRODUCT SPECIFICATION		
TITLE PCI EXPRESS GENERATION II 1MM PITCH CONNECTOR		PAGE Page 2 of 9	REVISION D
		AUTHORIZED BY HONGTU ZHANG	DATE Mar/02/12
CLASSIFICATION UNRESTRICTED			

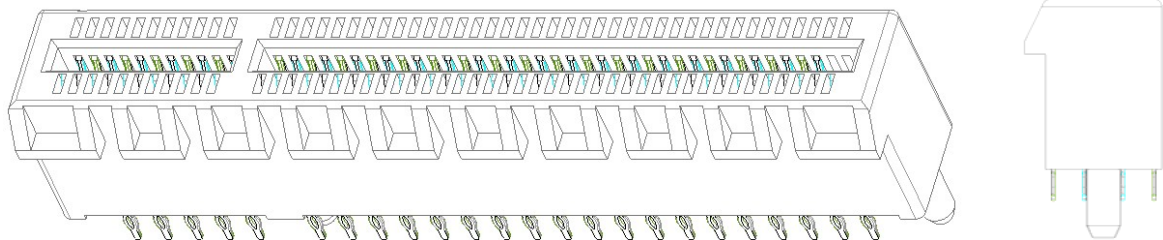

(With Retention Ridge)

Note: Please refer FCI customer drawing for most updated product profile, dimensions, plating options, recommended module card and footprint layout. This specification only shows Press-Fit type connector profile only. SIOM type profile is not shown in this document as well.

2.2 Material:

Parts	Material	Finish / Grade	Remark
Housing	High performance plastic with glass fiber reinforced	UL 94-V0	
Terminal	High performance copper alloy	Under plate: 50u" Nickel Contact: gold plated Solder tail: 100u"min pure matte Tin or Sn/Pb	
Hold down	Copper alloy	plate: 50u" Nickel overall + 100u" min pure matte Tin	For Dip and SMT types

The part number with "LF" suffix is lead free and meets the RoHS requirements for banned substances and can withstand the heat requirements of 260 °C for 5 sec in reflow process.

2.3 Recommended food print & module configuration:

Please refer customer drawing for details. This product compliant with PCI Express Card Electromechanical Specification (PCI-SIG document).

NUMBER GS-12-584	TYPE PRODUCT SPECIFICATION		
TITLE PCI EXPRESS GENERATION II 1MM PITCH CONNECTOR		PAGE Page 3 of 9	REVISION D
		AUTHORIZED BY HONGTU ZHANG	DATE Mar/02/12
CLASSIFICATION UNRESTRICTED			

2.4 Recommended work rating & temperature range:

<i>Item</i>	<i>Rating</i>
Voltage	30 V Max. (AC/DC)
Current	1.1 A Max. (Per Pin)
Storage temperature	-40 °C ~ 65 °C
Operating Temperature	-55 °C ~ 85 °C
Field Life	7 Years

3.0 Requirements:

3.1 Mechanical Characteristics:

Item	Description	Test method & Conditions	Requirement
3.1.1	Product examination	Sample must comply to applicable FCI product print	No physical damage
3.1.2	Durability	50 times mating/unmating cycles with 25.4 mm/minute rate per EIA-364-09	No physical damage or functional fail
3.1.3	Durability (pre-conditioning)	20 times mating/unmating cycles with 25.4 mm/minute rate per EIA-364-09	No physical damage or functional fail
3.1.4	Reseating	Manually plug/unplug the card with PCB, 3 cycles	No physical damage
3.1.5	Module insertion force	Insert a 1.70mm thickness steel gauge with 25.4 mm/minute rate per EIA-364-13	1.15 N Max. per pin pair
3.1.6	Module withdraw force	Withdraw a 1.44mm thickness steel gauge with 25.4 mm/minute rate per EIA-364-13	0.15 N Min. per pin pair
3.1.7	Terminal retention force (from housing)	Pull the terminals out of the connector housing with 1.27 mm/min rate	300 gf Min. per pin
3.1.8	Terminal (EON) insertion force (to PCB)	Insert the contact to a 0.62 mm diameter plated PCB hole with 25 mm/minute rate (For Press-Fit type connector only)	4.54 kgf Max. per pin
3.1.9	Terminal (EON) retention force (to PCB)	Pull the contact from a 0.78 mm diameter plated PCB hole with 25 mm/minute rate (For Press-Fit type connector only)	0.67 kgf Min. per pin

NUMBER GS-12-584	TYPE PRODUCT SPECIFICATION		
TITLE PCI EXPRESS GENERATION II 1MM PITCH CONNECTOR		PAGE Page 4 of 9	REVISION D
		AUTHORIZED BY HONGTU ZHANG	DATE Mar/02/12
CLASSIFICATION UNRESTRICTED			

Electrical Characteristics:

3.2.a DC Electrical:

Item	Description	Test method & Condition	Requirement
3.2.1	Contact resistance	Measure LLCR with 4-wire resistance meter. The test current shall be 100 mA with a max. open circuit 20 mV per EIA364-23. See figure A. below.	Initial: 30 mΩ max. After test: $\Delta R = 10 \text{ m}\Omega$ max
3.2.2	Insulation resistance	Connector shall be unmated and unmount. Give electrical loaded in accordance per EIA 364-21.	1000 Mega-ohm min.
3.2.3	Dielectric withstanding voltage	Load 300V AC, 60 Hz for 1 minute to adjacent pins of an unmated connector per EIA364-20.	No flashover or breakdown
3.2.4	Current rating	A connector mounted to the PCB. Wire the 8 power pins and the 8 nearest ground pins in a series circuit. The add-in card is included in this circuit. The add-in shall have 1 oz. copper traces and its mating geometry shall confirm to the applicable PCI Express drawings. Apply 1.1A current per EIA364-70, method 2 under the 25°C ambient condition. Measure the temperature rise.	ΔT rise: 30 °C max.

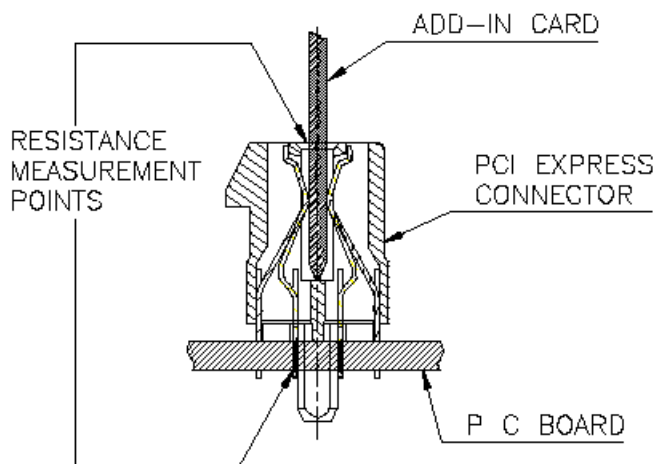

NUMBER GS-12-584	TYPE PRODUCT SPECIFICATION		
TITLE PCI EXPRESS GENERATION II 1MM PITCH CONNECTOR		PAGE Page 5 of 9	REVISION D
		AUTHORIZED BY HONGTU ZHANG	DATE Mar/02/12
CLASSIFICATION UNRESTRICTED			

(Figure A.)

3.2.b Signal Integrity:

Item	Description	Test method & Condition	Requirement
3.2.5	Differential insertion loss (DDIL)	Per EIA-364-101 and PCI Express Card Electromechanical Specification	$\geq -0.5 \text{ dB} \leq 2.5 \text{ GHz}$ $\geq -[0.8 \times (f-2.5)+0.5] \text{ dB}$ for $2.5 \rightarrow 5 \text{ GHz}$ $\geq -[3.0 \times (f-5)+2.5] \text{ dB}$ for $5 \rightarrow 7.5 \text{ GHz}$
3.2.6	Differential return loss (DDRL)	Per EIA-364-108 and PCI Express Card Electromechanical Specification	$\leq -15 \text{ dB} \leq 3 \text{ GHz}$ $\leq -5 \text{ dB}$ for $3 \rightarrow 5 \text{ GHz}$ $\leq -1 \text{ dB}$ for $5 \rightarrow 7 \text{ GHz}$
3.2.7	Differential near end cross talk (DDNEXT)	Per EIA-364-90 and PCI Express Card Electromechanical Specification	$\leq -32 \text{ dB} \leq 2.5 \text{ GHz}$ $\leq -26 \text{ dB}$ for $2.5 \rightarrow 5 \text{ GHz}$ $\leq -20 \text{ dB}$ for $5 \rightarrow 7 \text{ GHz}$
3.2.8	Intra-pair skew	Simulation data. Measurement is not required	5 ps max.

NUMBER GS-12-584	TYPE PRODUCT SPECIFICATION		
TITLE PCI EXPRESS GENERATION II 1MM PITCH CONNECTOR		PAGE Page 6 of 9	REVISION D
		AUTHORIZED BY HONGTU ZHANG	DATE Mar/02/12
CLASSIFICATION UNRESTRICTED			

3.3 Environmental Characteristics:

Item	Description	Test method & Condition	Requirement
3.3.1	Random vibration	EIA-364-28, test condition VII, test condition letter D Duration: 15 minutes per axis for all 3 axes on all samples. Frequency Range: 5 Hz to 500 Hz. Input acceleration is 3.10 g RMS; Random control limit tolerance: ± 3 dB.	No physical damage Signal discontinuities $\leq 1\mu$ sec during the test
3.3.2	High temperature life	Test per EIA-364-17 Method A, Temperature life at 105 \square , 168 hrs.	
3.3.3	High temperature life (preconditioning)	Test per EIA-364-17 Method A, Temperature life at 105 \square , 92 hrs.	
3.3.4	Thermal shock	Per EIA 364-32 , test condition 1, 10 cycles. Cycling the connector at -55 to $+85$ \square C. Dwell time of 30 minutes at extreme temperature, transfer time 5 mins Max.	
3.3.5	Cyclic temperature & humidity	EIA 364-31 Specimens shall be mated during test, Cycling the connecto between 25 \square +/- 3 \square at 80% RH and 65 +/- 3 \square C at 50% RH, Ramp times should be 0.5 hour and dwell times be 1 hour. Perform 24 cycles.	
3.3.6	Mixed flowing gas	Per EIA364-65 class IIA 10 days to simulate a 7 year field life	
3.3.7	Thermal disturbance	Cycling the connector between 15 \square +/- 3 \square and 85 +/- 3 \square , Thermal ramp 2 \square /minute Min. Dwell times should insure that the contacts reach the temperature extremes at least 5 minutes. Perform 10 such cycles. Per EIA-364-1000.01	

NUMBER GS-12-584	TYPE PRODUCT SPECIFICATION		
TITLE PCI EXPRESS GENERATION II 1MM PITCH CONNECTOR		PAGE Page 7 of 9	REVISION D
		AUTHORIZED BY HONGTU ZHANG	DATE Mar/02/12
CLASSIFICATION UNRESTRICTED			

3.3.8	Resistance to soldering heat	Per EIA-364-56 procedure 3, test condition C. 260 +/-5 □, 10 +/- 2 seconds. (For TH, SMT types connector only)	No physical damage
3.3.9	RoHS Compatible	FCI P/N with "LF" suffix means lead free and this product meets European Union Directives regulations on banned substance: Lead : 1000 PPM Cadmium: 100 PPM Mercury: 1000 PPM Hexavalent Chromium: 1000 PPM PBBs : 1000 PPM PBDEs: 1000 PPM.	Not exceed the threshold level for all homogenous materials.

4.0 Product Qualification Provision:

4.1 Inspection condition:

Unless otherwise specified, all measurement and tests shall be carried out at temperatures between 15 □ and 35 □, relative humidity of 40% to 85% and atmospheric pressure (960hpa to 1060hpa).

4.2 Test plan/matrix: (See Next Page)

Note: 164P type connector is the selected sample for tests. (64P for group 9)

PDS: Rev :D

STATUS:Released

Printed: Mar 12, 2012

NUMBER GS-12-584	TYPE PRODUCT SPECIFICATION		
TITLE PCI EXPRESS GENERATION II 1MM PITCH CONNECTOR		PAGE Page 8 of 9	REVISION D
		AUTHORIZED BY HONGTU ZHANG	DATE Mar/02/12
CLASSIFICATION UNRESTRICTED			

Test items	Refer to	TEST GROUP									
		1	2	3	4	5	6	7	8	9	10
Visual inspection	3.1.1	1	1	1	1	1	1	1	1	1	
Durability	3.1.2					4					
Durability (preconditioning)	3.1.3	3	3	3	3						
Reseating	3.1.4	6	9		10						
Module insertion / withdraw force	3.1.5 & 3.1.6							2			
LLCR	3.2.1	2,5,7	2,5,8,10	2,5,7	2,5,7,9,11	3,5					
Insulation resistance	3.2.2		7								
Dielectric withstanding voltage	3.2.3					2,6					
Current Rating	3.2.4						2				
Random vibration	3.3.1			6							
High temperature life	3.3.2	4									
High temperature life (preconditioning)	3.3.3			4	4						
Thermal shock	3.3.4		4								
Cycling temperature & humidity	3.3.5		6								
Mixed flowing gas	3.3.6				6						
Thermal disturbance	3.3.7				8						
Contact retention force (from housing)	3.1.7							3			
EON insertion / retention force	3.1.8 & 3.1.9								2		
Resistance to soldering heat	3.3.8										2
Signal Integrity	3.2.b									2	

PDS: Rev :D

STATUS:Released

Printed: Mar 12, 2012

NUMBER GS-12-584	TYPE PRODUCT SPECIFICATION		
TITLE PCI EXPRESS GENERATION II 1MM PITCH CONNECTOR		PAGE Page 9 of 9	REVISION D
		AUTHORIZED BY HONGTU ZHANG	DATE Mar/02/12
CLASSIFICATION UNRESTRICTED			

Sample Quantity		5	5	5	5	5	5	5	5	5
-----------------	--	---	---	---	---	---	---	---	---	---

5.0 Packaging and handling:

5.1 Packaging per FCI spec GS-14-858(DIP or SMT types) or GS-14-974(Press-Fit type). The traceability of all parts must be guaranteed by date code on each product.

REVISION RECORD

REV	PAGE	DESCRIPTION	EC #	DATE
A	All	New product spec release	DG08-0268	Mar/09/09
B	2	Add Sn/Pb (per customer's request)	T09-1040	Mar/25/09
C	3	Modify operation voltage and add "Max." for current	T09-1068	May/13/09
D	1	Add P/N 10116975-xxxxx	DG-010578	Mar/12/12



Стандарт Электрон Связь

Мы молодая и активно развивающаяся компания в области поставок электронных компонентов. Мы поставляем электронные компоненты отечественного и импортного производства напрямую от производителей и с крупнейших складов мира.

Благодаря сотрудничеству с мировыми поставщиками мы осуществляем комплексные и плановые поставки широчайшего спектра электронных компонентов.

Собственная эффективная логистика и склад в обеспечивает надежную поставку продукции в точно указанные сроки по всей России.

Мы осуществляем техническую поддержку нашим клиентам и предпродажную проверку качества продукции. На все поставляемые продукты мы предоставляем гарантию .

Осуществляем поставки продукции под контролем ВП МО РФ на предприятия военно-промышленного комплекса России , а также работаем в рамках 275 ФЗ с открытием отдельных счетов в уполномоченном банке. Система менеджмента качества компании соответствует требованиям ГОСТ ISO 9001.

Минимальные сроки поставки, гибкие цены, неограниченный ассортимент и индивидуальный подход к клиентам являются основой для выстраивания долгосрочного и эффективного сотрудничества с предприятиями радиоэлектронной промышленности, предприятиями ВПК и научно-исследовательскими институтами России.

С нами вы становитесь еще успешнее!

Наши контакты:

Телефон: +7 812 627 14 35

Электронная почта: sales@st-electron.ru

Адрес: 198099, Санкт-Петербург,
Промышленная ул, дом № 19, литера Н,
помещение 100-Н Офис 331