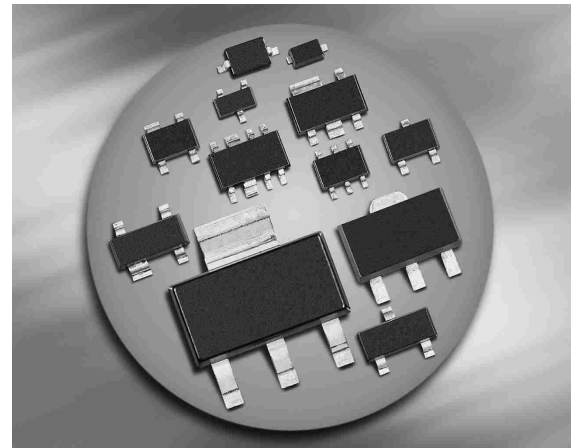
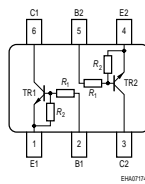
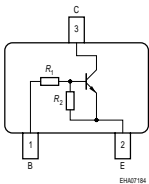

NPN Silicon Digital Transistor

- Switching circuit, inverter, interface circuit driver circuit
- Built in bias resistor ($R_1=47\text{ k}\Omega$, $R_2=47\text{ k}\Omega$)
- BCR148S: Two internally isolated transistors with good matching in one multichip package
- BCR148S: For orientation in reel see package information below
- Pb-free (RoHS compliant) package ¹⁾
- Qualified according AEC Q101

BCR148/F
BCR148W
BCR148S

Type	Marking	Pin Configuration						Package
		1=B	2=E	3=C	-	-	-	
BCR148	WEs	1=B	2=E	3=C	-	-	-	SOT23
BCR148F	WEs	1=B	2=E	3=C	-	-	-	TSFP-3
BCR148S	WEs	1=E1	2=B1	3=C2	4=E2	5=B2	6=C1	SOT363
BCR148W	WEs	1=B	2=E	3=C	-	-	-	SOT323

¹⁾Pb-containing package may be available upon special request

Maximum Ratings

Parameter	Symbol	Value	Unit
Collector-emitter voltage	V_{CEO}	50	V
Collector-base voltage	V_{CBO}	50	
Input forward voltage	$V_{i(fwd)}$	80	
Input reverse voltage	$V_{i(rev)}$	10	
Collector current	I_C	100	mA
Total power dissipation- BCR148, $T_S \leq 102^\circ\text{C}$ BCR148F, $T_S \leq 128^\circ\text{C}$ BCR148S, $T_S \leq 115^\circ\text{C}$ BCR148W, $T_S \leq 124^\circ\text{C}$	P_{tot}	200 250 250 250	mW
Junction temperature	T_j	150	°C
Storage temperature	T_{stg}	-65 ... 150	

Thermal Resistance

Parameter	Symbol	Value	Unit
Junction - soldering point ¹⁾	R_{thJS}		K/W
BCR148		≤ 240	
BCR148F		≤ 90	
BCR148S		≤ 140	
BCR148W		≤ 105	

¹For calculation of R_{thJA} please refer to Application Note Thermal Resistance

Electrical Characteristics at $T_A = 25^\circ\text{C}$, unless otherwise specified

Parameter	Symbol	Values			Unit
		min.	typ.	max.	
DC Characteristics					
Collector-emitter breakdown voltage $I_C = 100\ \mu\text{A}, I_B = 0$	$V_{(BR)CEO}$	50	-	-	V
Collector-base breakdown voltage $I_C = 10\ \mu\text{A}, I_E = 0$	$V_{(BR)CBO}$	50	-	-	
Collector-base cutoff current $V_{CB} = 40\ \text{V}, I_E = 0$	I_{CBO}	-	-	100	nA
Emitter-base cutoff current $V_{EB} = 10\ \text{V}, I_C = 0$	I_{EBO}	-	-	164	μA
DC current gain ¹⁾ $I_C = 5\ \text{mA}, V_{CE} = 5\ \text{V}$	h_{FE}	70	-	-	-
Collector-emitter saturation voltage ¹⁾ $I_C = 10\ \text{mA}, I_B = 0.5\ \text{mA}$	V_{CEsat}	-	-	0.3	V
Input off voltage $I_C = 100\ \mu\text{A}, V_{CE} = 5\ \text{V}$	$V_{i(off)}$	0.8	-	1.5	
Input on voltage $I_C = 2\ \text{mA}, V_{CE} = 0.3\ \text{V}$	$V_{i(on)}$	1	-	3	
Input resistor	R_1	32	47	62	$\text{k}\Omega$
Resistor ratio	R_1/R_2	0.9	1	1.1	-
AC Characteristics					
Transition frequency $I_C = 10\ \text{mA}, V_{CE} = 5\ \text{V}, f = 100\ \text{MHz}$	f_T	-	100	-	MHz
Collector-base capacitance $V_{CB} = 10\ \text{V}, f = 1\ \text{MHz}$	C_{cb}	-	3	-	pF

¹⁾Pulse test: $t < 300\ \mu\text{s}; D < 2\%$

DC current gain $h_{FE} = f(I_C)$

$V_{CE} = 5V$ (common emitter configuration)

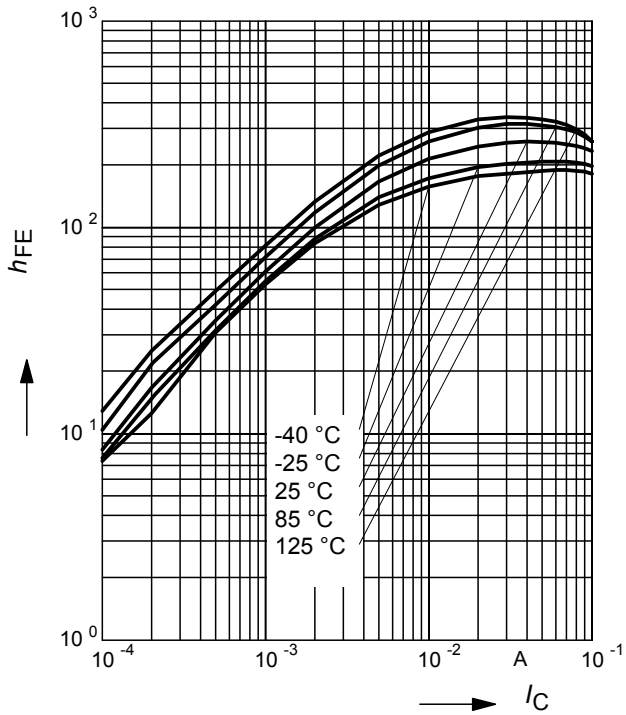

Collector-emitter saturation voltage

$V_{CEsat} = f(I_C), I_C/I_B = 20$

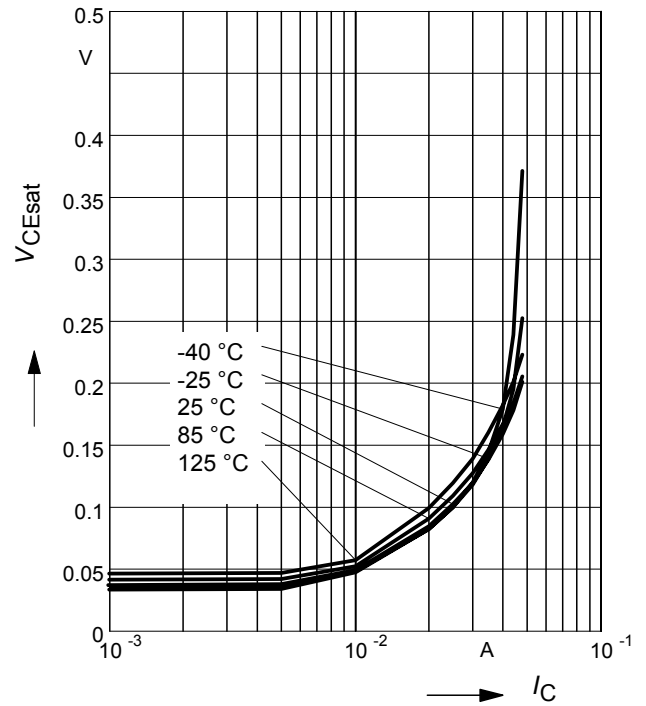

Input on Voltage $V_{i(on)} = f(I_C)$

$V_{CE} = 0.3V$ (common emitter configuration)

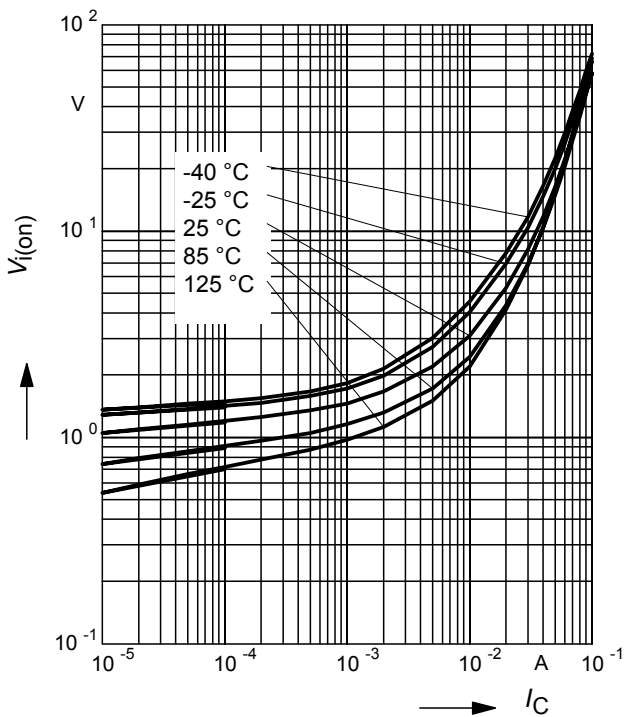

Input off voltage $V_{i(off)} = f(I_C)$

$V_{CE} = 5V$ (common emitter configuration)

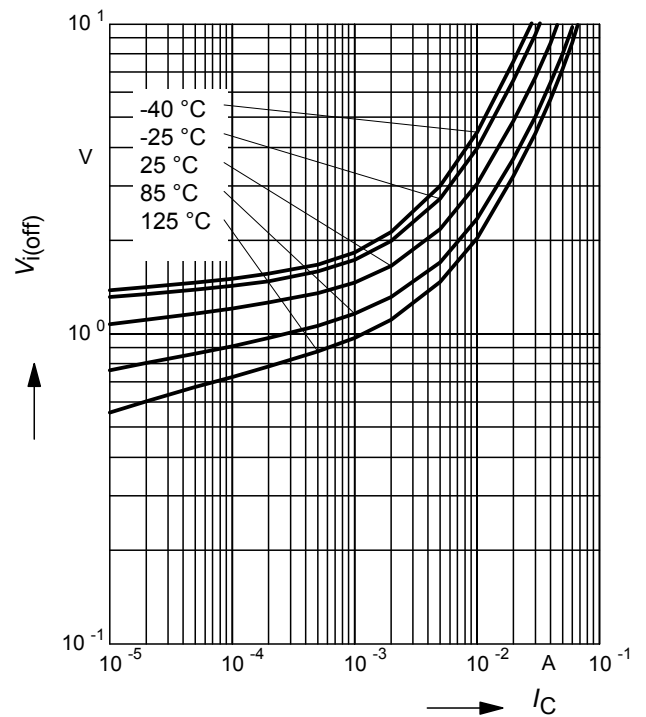

Total power dissipation $P_{tot} = f(T_S)$

BCR148



Total power dissipation $P_{tot} = f(T_S)$

BCR148F



Total power dissipation $P_{tot} = f(T_S)$

BCR148S

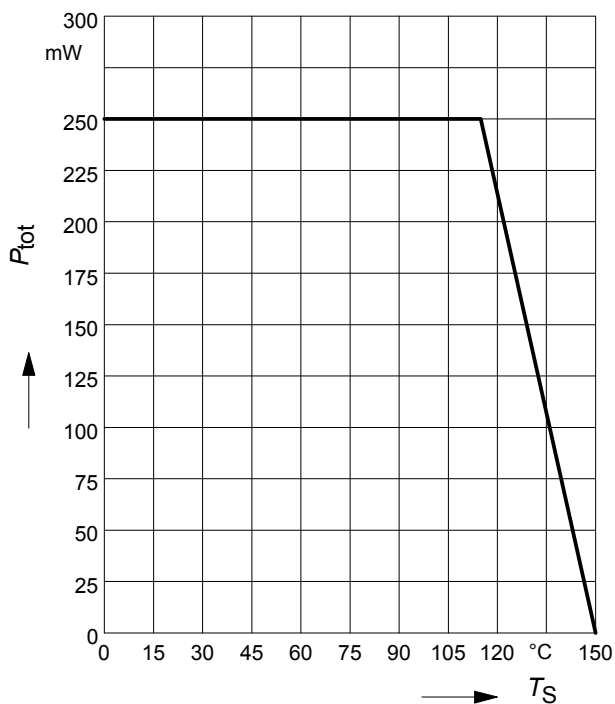

Total power dissipation $P_{tot} = f(T_S)$

BCR148W

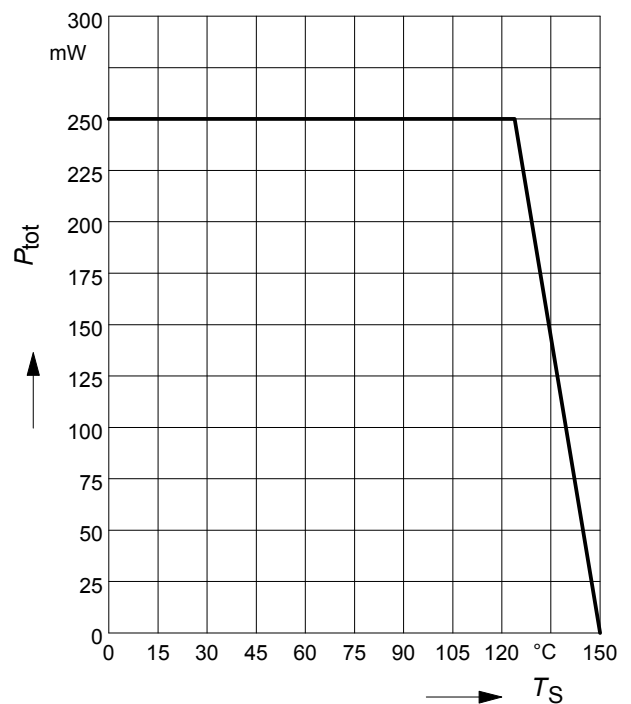

Permissible Pulse Load $R_{thJS} = f(t_p)$

BCR148



Permissible Pulse Load

$P_{totmax}/P_{totDC} = f(t_p)$

BCR148



Permissible Puls Load $R_{thJS} = f(t_p)$

BCR148F

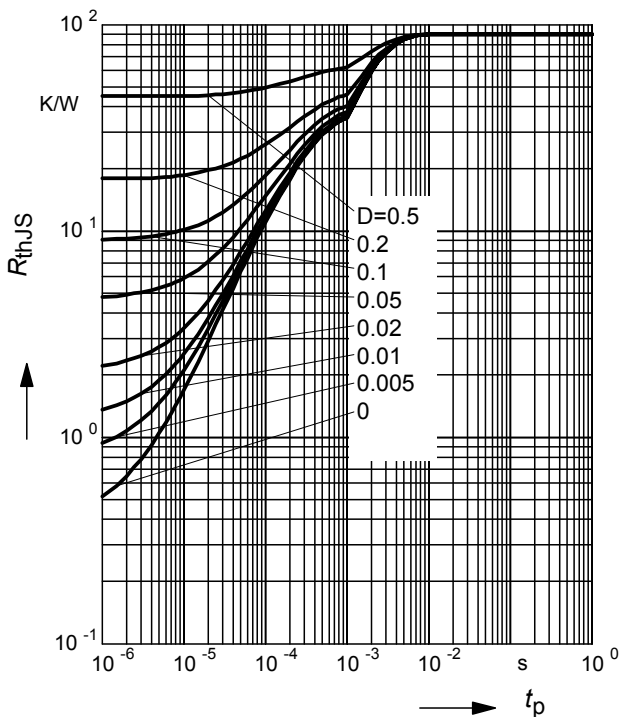

Permissible Pulse Load

$P_{totmax}/P_{totDC} = f(t_p)$

BCR148F



Permissible Puls Load $R_{thJS} = f(t_p)$

BCR148S

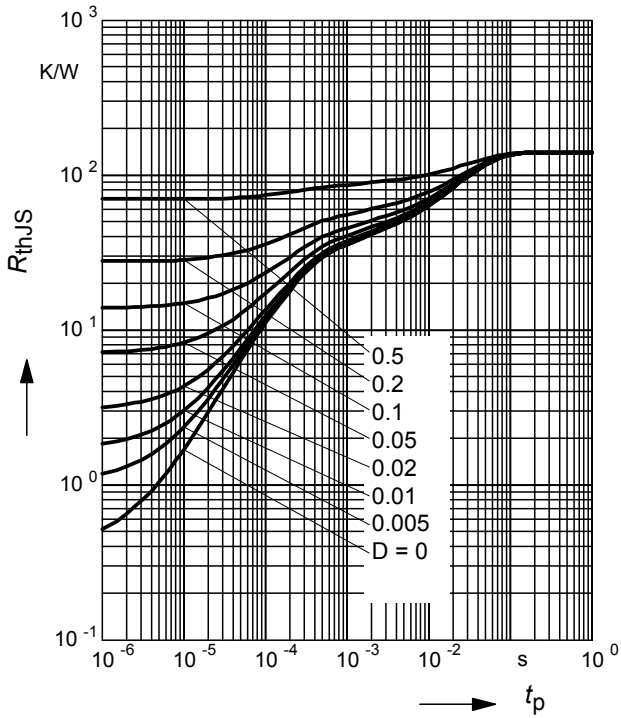

Permissible Pulse Load

$P_{totmax}/P_{totDC} = f(t_p)$

BCR148S



Permissible Puls Load $R_{thJS} = f(t_p)$

BCR148W

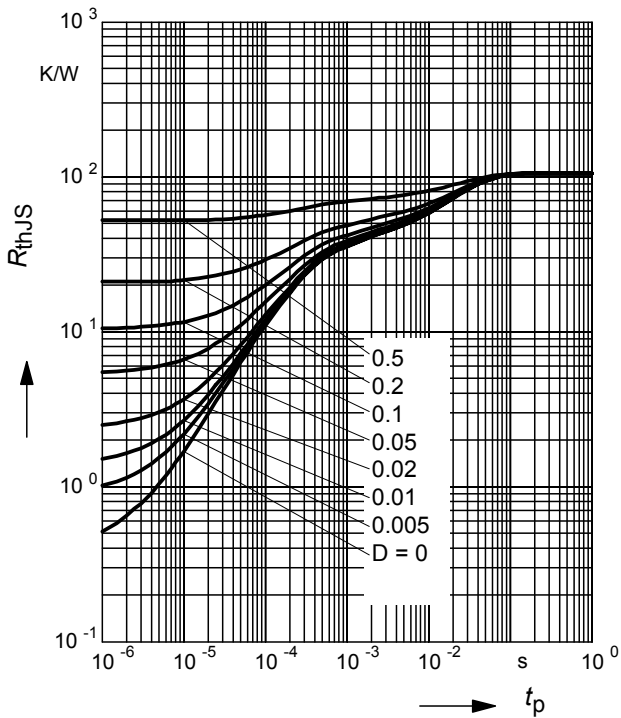

Permissible Pulse Load

$P_{totmax}/P_{totDC} = f(t_p)$

BCR148W

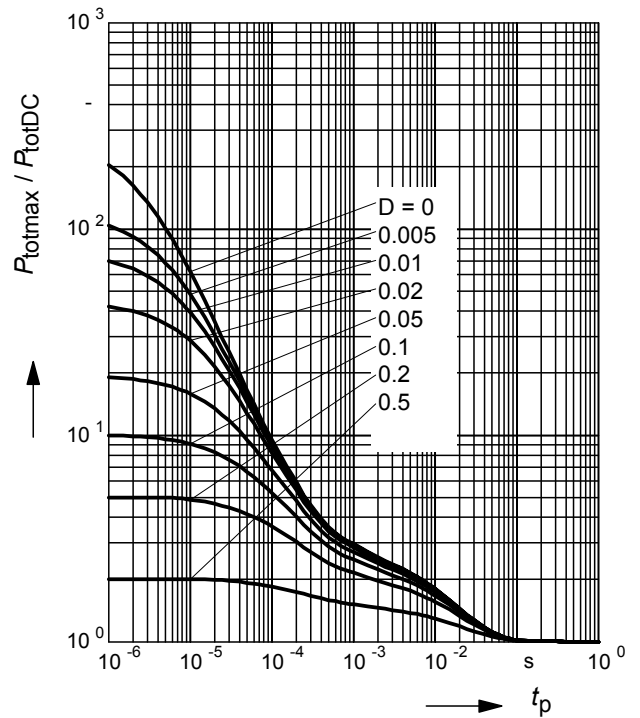

Package Outline

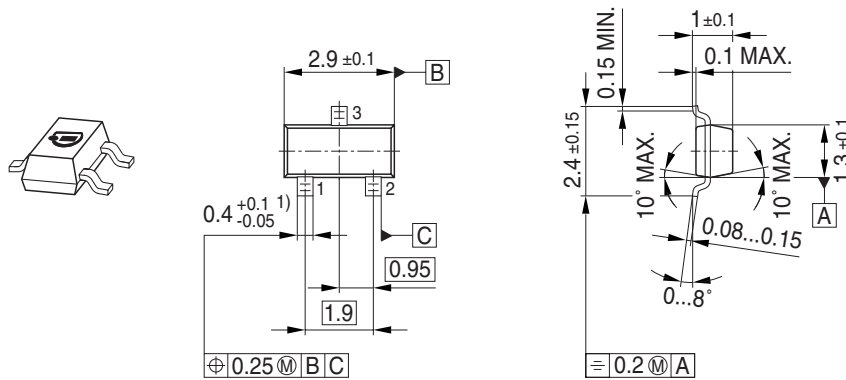

1) Lead width can be 0.6 max. in dambar area

Foot Print

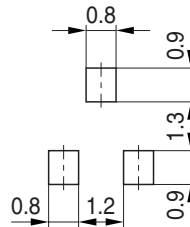

Marking Layout (Example)

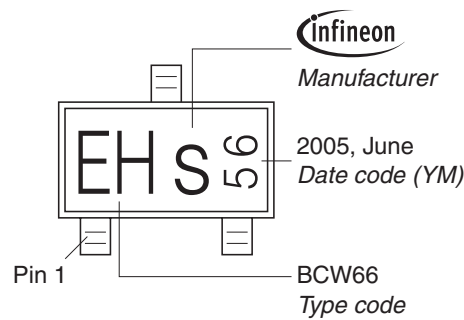

Standard Packing

Reel \varnothing 180 mm = 3.000 Pieces/Reel
 Reel \varnothing 330 mm = 10.000 Pieces/Reel

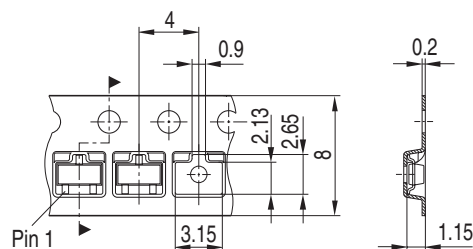

Package Outline



Foot Print

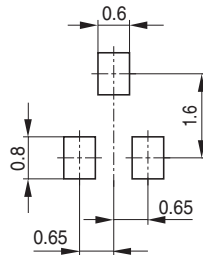

Marking Layout (Example)

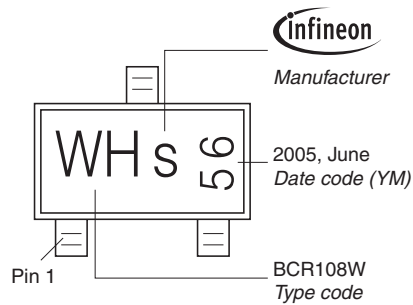

Standard Packing

Reel \varnothing 180 mm = 3.000 Pieces/Reel
 Reel \varnothing 330 mm = 10.000 Pieces/Reel



Package Outline



Foot Print



Marking Layout (Example)

Small variations in positioning of Date code, Type code and Manufacture are possible.



Standard Packing

Reel \varnothing 180 mm = 3.000 Pieces/Reel
 Reel \varnothing 330 mm = 10.000 Pieces/Reel

For symmetric types no defined Pin 1 orientation in reel.



Package Outline

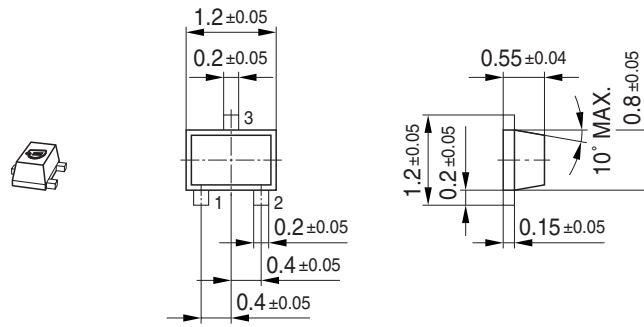

Foot Print

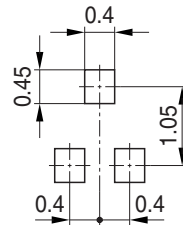

Marking Layout (Example)

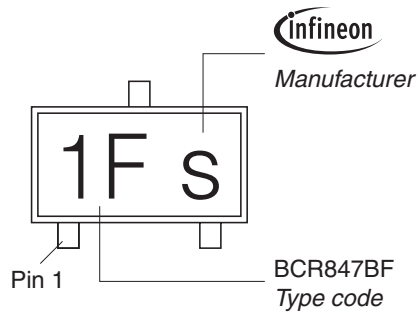

Standard Packing

Reel ø180 mm = 3.000 Pieces/Reel
 Reel ø330 mm = 10.000 Pieces/Reel

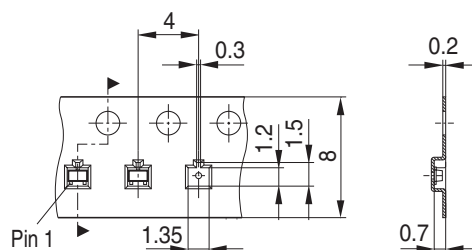

Edition 2006-02-01
Published by
Infineon Technologies AG
81726 München, Germany
© Infineon Technologies AG 2007.
All Rights Reserved.

Attention please!

The information given in this dokument shall in no event be regarded as a guarantee of conditions or characteristics ("Beschaffenheitsgarantie"). With respect to any examples or hints given herein, any typical values stated herein and/or any information regarding the application of the device, Infineon Technologies hereby disclaims any and all warranties and liabilities of any kind, including without limitation warranties of non-infringement of intellectual property rights of any third party.

Information

For further information on technology, delivery terms and conditions and prices please contact your nearest Infineon Technologies Office (www.infineon.com).

Warnings

Due to technical requirements components may contain dangerous substances. For information on the types in question please contact your nearest Infineon Technologies Office.

Infineon Technologies Components may only be used in life-support devices or systems with the express written approval of Infineon Technologies, if a failure of such components can reasonably be expected to cause the failure of that life-support device or system, or to affect the safety or effectiveness of that device or system.

Life support devices or systems are intended to be implanted in the human body, or to support and/or maintain and sustain and/or protect human life. If they fail, it is reasonable to assume that the health of the user or other persons may be endangered.



Стандарт Электрон Связь

Мы молодая и активно развивающаяся компания в области поставок электронных компонентов. Мы поставляем электронные компоненты отечественного и импортного производства напрямую от производителей и с крупнейших складов мира.

Благодаря сотрудничеству с мировыми поставщиками мы осуществляем комплексные и плановые поставки широчайшего спектра электронных компонентов.

Собственная эффективная логистика и склад в обеспечивает надежную поставку продукции в точно указанные сроки по всей России.

Мы осуществляем техническую поддержку нашим клиентам и предпродажную проверку качества продукции. На все поставляемые продукты мы предоставляем гарантию .

Осуществляем поставки продукции под контролем ВП МО РФ на предприятия военно-промышленного комплекса России , а также работаем в рамках 275 ФЗ с открытием отдельных счетов в уполномоченном банке. Система менеджмента качества компании соответствует требованиям ГОСТ ISO 9001.

Минимальные сроки поставки, гибкие цены, неограниченный ассортимент и индивидуальный подход к клиентам являются основой для выстраивания долгосрочного и эффективного сотрудничества с предприятиями радиоэлектронной промышленности, предприятиями ВПК и научно-исследовательскими институтами России.

С нами вы становитесь еще успешнее!

Наши контакты:

Телефон: +7 812 627 14 35

Электронная почта: sales@st-electron.ru

Адрес: 198099, Санкт-Петербург,
Промышленная ул, дом № 19, литера Н,
помещение 100-Н Офис 331