

# CC1200 Low-Power, High-Performance RF Transceiver

## 1 Device Overview

### 1.1 Features

- RF Performance and Analog Features:
  - High-Performance, Single-Chip Transceiver
    - Excellent Receiver Sensitivity:
      - –123 dBm at 1.2 kbps
      - –109 dBm at 50 kbps
    - Blocking Performance: 86 dB at 10 MHz
    - Adjacent Channel Selectivity: Up to 60 dB at 12.5-kHz Offset
    - Very Low Phase Noise: –114 dBc/Hz at 10-kHz Offset (169 MHz)
  - Programmable Output Power Up to +16 dBm With 0.4-dB Step Size
  - Automatic Output Power Ramping
  - Supported Modulation Formats: 2-FSK, 2-GFSK, 4-FSK, 4-GFSK, MSK, OOK
  - Supports Data Rate Up to 1.25 Mbps in Transmit and Receive
- Low Current Consumption:
  - Enhanced Wake-On-Radio (eWOR) Functionality for Automatic Low-Power Receive Polling
  - Power Down: 0.12  $\mu$ A (0.5  $\mu$ A With eWOR Timer Active)
    - RX: 0.5 mA in RX Sniff Mode
    - RX: 19 mA Peak Current in Low-Power Mode
    - RX: 23 mA Peak Current in High-Performance Mode
    - TX: 46 mA at +14 dBm
- Other:
  - Data FIFOs: Separate 128-Byte RX and TX
  - Support for Seamless Integration With the CC1190 Device for Increased Range Providing up to 3-dB Improvement in RX Sensitivity and up to +27 dBm TX Output Power
- Digital Features:
  - WaveMatch: Advanced Digital Signal Processing for Improved Sync Detect Performance
  - Security: Hardware AES128 Accelerator
  - Data FIFOs: Separate 128-Byte RX and TX
  - Includes Functions for Antenna Diversity Support
  - Support for Retransmission
  - Support for Auto-Acknowledge of Received Packets
  - Automatic Clear Channel Assessment (CCA) for Listen-Before-Talk (LBT) Systems
  - Built-in Coding Gain Support for Increased Range and Robustness
  - Digital RSSI Measurement
  - Improved OOK Shaping for Less Occupied Bandwidth, Enabling Higher Output Power While Meeting Regulatory Requirements
- Dedicated Packet Handling for 802.15.4g:
  - CRC 16/32
  - FEC, Dual Sync Detection (FEC and non-FEC Packets)
  - Whitening
- General:
  - RoHS-Compliant 5-mm x 5-mm No-Lead QFN 32-Pin Package (RHB)
  - Pin-Compatible With the CC1120 Device
- Regulations – Suitable for Systems Targeting Compliance With
  - **Europe:** ETSI EN 300 220, EN 54-25
  - **US:** FCC CFR47 Part 15, FCC CFR47 Part 90
  - **Japan:** ARIB STD-T30, T67, T108

### 1.2 Applications

- Low-Power, High-Performance, Wireless Systems With Data Rate Up to 1250 kbps
- ISM/SRD Bands: 169, 433, 868, 915, and 920 MHz
- Possible Support for Additional Frequency Bands: 137 to 158.3 MHz, 205 to 237.5 MHz, and 274 to 316.6 MHz
- Smart Metering (AMR/AMI)
- Home and Building Automation
- Wireless Alarm and Security Systems
- Industrial Monitoring and Control
- Wireless Healthcare Applications
- Wireless Sensor Networks and Active RFID
- IEEE 802.15.4g Applications
- Wireless M-Bus, All Modes



### 1.3 Description

The CC1200 device is a fully integrated single-chip radio transceiver designed for high performance at very low-power and low-voltage operation in cost-effective wireless systems. All filters are integrated, thus removing the need for costly external SAW and IF filters. The device is mainly intended for the ISM (Industrial, Scientific, and Medical) and SRD (Short Range Device) frequency bands at 164–190 MHz, 410–475 MHz, and 820–950 MHz.

The CC1200 device provides extensive hardware support for packet handling, data buffering, burst transmissions, clear channel assessment, link quality indication, and Wake-On-Radio. The main operating parameters of the CC1200 device can be controlled through an SPI interface. In a typical system, the CC1200 device will be used with a microcontroller and only a few external passive components.

The CC1200 and the CC1120 devices are both part of the high-performance transceiver family. The CC1120 device is more optimized toward narrowband applications, while the CC1200 device is optimized toward wideband applications but can also effectively cover narrowband down to 12.5-kHz channels.

#### Device Information<sup>(1)</sup>

PART NUMBER	PACKAGE	BODY SIZE
CC1200RHB	VQFN (32)	5.00 mm x 5.00 mm

(1) For more information, see [Section 8, Mechanical Packaging and Orderable Information](#)

### 1.4 Functional Block Diagram

Figure 1-1 shows the system block diagram of the CC120x family of devices.

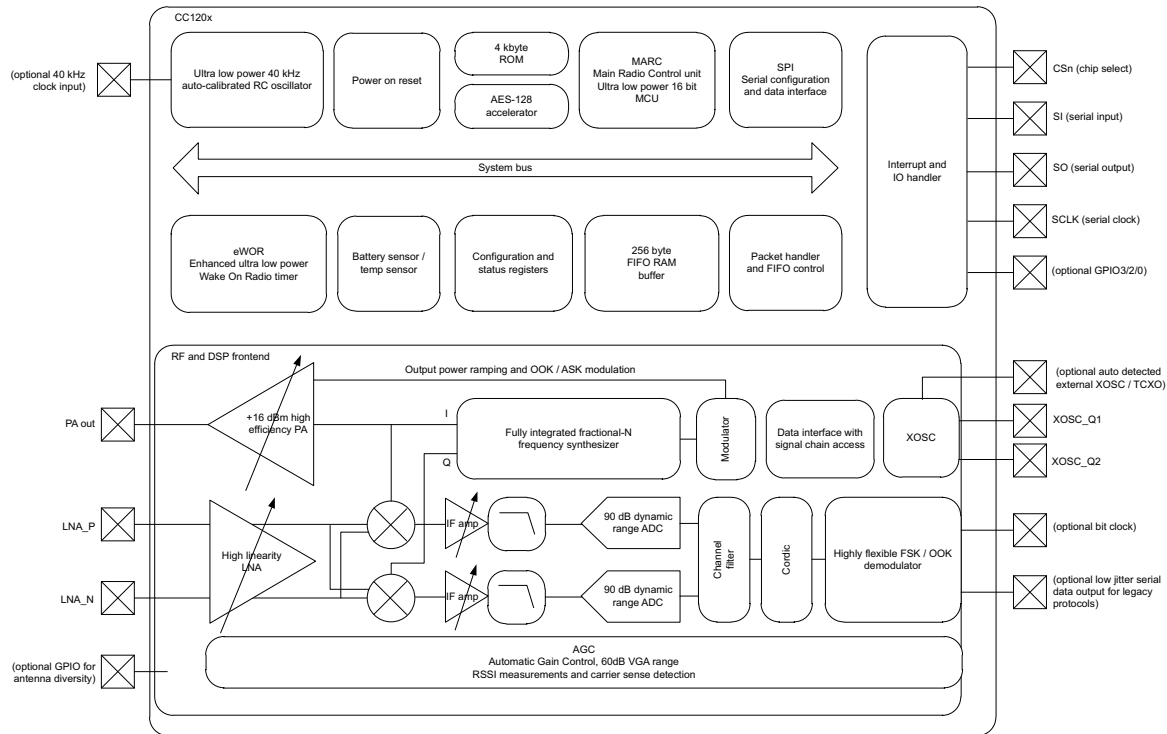

Figure 1-1. Functional Block Diagram

## Table of Contents

<b>1 Device Overview</b> ..... <a href="#">1</a>	
1.1 Features ..... <a href="#">1</a>	4.15 40-MHz Clock Input (TCXO) ..... <a href="#">15</a>
1.2 Applications ..... <a href="#">1</a>	4.16 32-kHz Clock Input ..... <a href="#">16</a>
1.3 Description ..... <a href="#">2</a>	4.17 40-kHz RC Oscillator ..... <a href="#">16</a>
1.4 Functional Block Diagram ..... <a href="#">2</a>	4.18 I/O and Reset ..... <a href="#">16</a>
<b>2 Revision History</b> ..... <a href="#">4</a>	4.19 Temperature Sensor ..... <a href="#">16</a>
<b>3 Terminal Configuration and Functions</b> ..... <a href="#">5</a>	4.20 Typical Characteristics ..... <a href="#">17</a>
3.1 Pin Diagram ..... <a href="#">5</a>	<b>5 Detailed Description</b> ..... <a href="#">20</a>
3.2 Pin Configuration ..... <a href="#">6</a>	5.1 Block Diagram ..... <a href="#">20</a>
<b>4 Specifications</b> ..... <a href="#">7</a>	5.2 Frequency Synthesizer ..... <a href="#">20</a>
4.1 Absolute Maximum Ratings ..... <a href="#">7</a>	5.3 Receiver ..... <a href="#">21</a>
4.2 Handling Ratings ..... <a href="#">7</a>	5.4 Transmitter ..... <a href="#">21</a>
4.3 Recommended Operating Conditions (General Characteristics) ..... <a href="#">7</a>	5.5 Radio Control and User Interface ..... <a href="#">21</a>
4.4 Thermal Resistance Characteristics for RHB Package ..... <a href="#">7</a>	5.6 Enhanced Wake-On-Radio (eWOR) ..... <a href="#">21</a>
4.5 RF Characteristics ..... <a href="#">8</a>	5.7 RX Sniff Mode ..... <a href="#">22</a>
4.6 Regulatory Standards ..... <a href="#">8</a>	5.8 Antenna Diversity ..... <a href="#">22</a>
4.7 Current Consumption, Static Modes ..... <a href="#">9</a>	5.9 WaveMatch ..... <a href="#">23</a>
4.8 Current Consumption, Transmit Modes ..... <a href="#">9</a>	<b>6 Typical Application Circuit</b> ..... <a href="#">24</a>
4.9 Current Consumption, Receive Modes ..... <a href="#">10</a>	<b>7 Device and Documentation Support</b> ..... <a href="#">25</a>
4.10 Receive Parameters ..... <a href="#">10</a>	7.1 Device Support ..... <a href="#">25</a>
4.11 Transmit Parameters ..... <a href="#">13</a>	7.2 Documentation Support ..... <a href="#">26</a>
4.12 PLL Parameters ..... <a href="#">14</a>	7.3 Community Resources ..... <a href="#">26</a>
4.13 Wake-up and Timing ..... <a href="#">15</a>	7.4 Trademarks ..... <a href="#">26</a>
4.14 40-MHz Crystal Oscillator ..... <a href="#">15</a>	7.5 Electrostatic Discharge Caution ..... <a href="#">26</a>
	7.6 Glossary ..... <a href="#">26</a>
	<b>8 Mechanical Packaging and Orderable Information</b> ..... <a href="#">27</a>

---

## 2 Revision History

NOTE: Page numbers for previous revisions may differ from page numbers in the current version.

This data manual revision history highlights the changes made to the SWRS123C device-specific data manual to make it an SWRS123D revision.

---

Changes from Revision C (June 2014) to Revision D	Page
• Added Ambient to the temperature range condition and removed Tj from Temperature range .....	<a href="#">7</a>
• Added data to TCXO table .....	<a href="#">15</a>

---

### 3 Terminal Configuration and Functions

#### 3.1 Pin Diagram

Figure 3-1 shows pin names and locations for the CC1200 device.

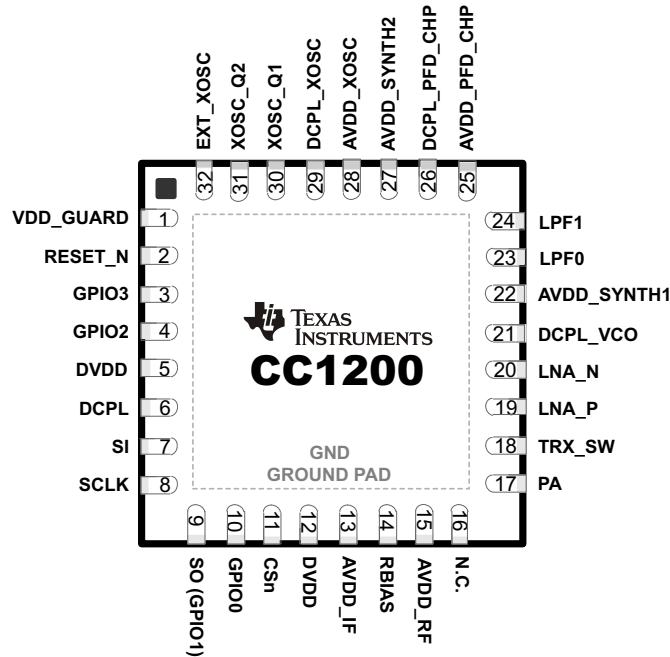

Figure 3-1. Package 5-mm x 5-mm QFN

## 3.2 Pin Configuration

The following table lists the pin-out configuration for the CC1200 device.

PIN NO.	PIN NAME	TYPE / DIRECTION	DESCRIPTION
1	VDD_GUARD	Power	2.0–3.6 V VDD
2	RESET_N	Digital input	Asynchronous, active-low digital reset
3	GPIO3	Digital I/O	General-purpose I/O
4	GPIO2	Digital I/O	General-purpose I/O
5	DVDD	Power	2.0–3.6 VDD to internal digital regulator
6	DCPL	Power	Digital regulator output to external decoupling capacitor
7	SI	Digital input	Serial data in
8	SCLK	Digital input	Serial data clock
9	SO(GPIO1)	Digital I/O	Serial data out (general-purpose I/O)
10	GPIO0	Digital I/O	General-purpose I/O
11	CSn	Digital input	Active-low chip select
12	DVDD	Power	2.0–3.6 V VDD
13	AVDD_IF	Power	2.0–3.6 V VDD
14	RBIAS	Analog	External high-precision resistor
15	AVDD_RF	Power	2.0–3.6 V VDD
16	N.C.		Not connected
17	PA	Analog	Single-ended TX output (requires DC path to VDD)
18	TRX_SW	Analog	TX and RX switch. Connected internally to GND in TX and floating (high-impedance) in RX.
19	LNA_P	Analog	Differential RX input (requires DC path to ground)
20	LNA_N	Analog	Differential RX input (requires DC path to ground)
21	DCPL_VCO	Power	Pin for external decoupling of VCO supply regulator
22	AVDD_SYNTH1	Power	2.0–3.6 V VDD
23	LPF0	Analog	External loop filter components
24	LPF1	Analog	External loop filter components
25	AVDD_PFD_CHP	Power	2.0–3.6 V VDD
26	DCPL_PFD_CHP	Power	Pin for external decoupling of PFD and CHP regulator
27	AVDD_SYNTH2	Power	2.0–3.6 V VDD
28	AVDD_XOSC	Power	2.0–3.6 V VDD
29	DCPL_XOSC	Power	Pin for external decoupling of XOSC supply regulator
30	XOSC_Q1	Analog	Crystal oscillator pin 1 (must be grounded if a TCXO or other external clock connected to EXT_XOSC is used)
31	XOSC_Q2	Analog	Crystal oscillator pin 2 (must be left floating if a TCXO or other external clock connected to EXT_XOSC is used)
32	EXT_XOSC	Digital input	Pin for external clock input (must be grounded if a regular crystal connected to XOSC_Q1 and XOSC_Q2 is used)
–	GND	Ground pad	The ground pad must be connected to a solid ground plane.

## 4 Specifications

All measurements performed on CC1200EM\_868\_930 rev.1.0.0, CC1200EM\_420\_470 rev.1.0.1, or CC1200EM\_169 rev.1.2.

### 4.1 Absolute Maximum Ratings<sup>(1)(2)</sup>

over operating free-air temperature range (unless otherwise noted)

PARAMETER	MIN	MAX	UNIT	CONDITION
Supply voltage (VDD, AVDD_x)	-0.3	3.9	V	All supply pins must have the same voltage
Input RF level		+10	dBm	
Voltage on any digital pin	-0.3	VDD+0.3	V	max 3.9 V
Voltage on analog pins (including DCPL pins)	-0.3	2.0	V	

- Stresses beyond those listed under absolute maximum ratings may cause permanent damage to the device. These are stress ratings only, and functional operation of the device at these or any other conditions beyond those indicated under general characteristics is not implied. Exposure to absolute-maximum-rated conditions for extended periods may affect device reliability.
- All voltage values are with respect to  $V_{SS}$ , unless otherwise noted.

### 4.2 Handling Ratings

		MIN	MAX	UNIT
$T_{stg}$	Storage temperature range	-40	125	°C
$V_{ESD}$	Electrostatic discharge (ESD) performance:	Human body model (HBM), per ANSI/ESDA/JEDEC JS001 <sup>(1)</sup>		kV
		Charged device model (CDM), per JESD22-C101 <sup>(2)</sup>	All pins	V

- JEDEC document JEP155 states that 500-V HBM allows safe manufacturing with a standard ESD control process.
- JEDEC document JEP157 states that 250-V HBM allows safe manufacturing with a standard ESD control process.

### 4.3 Recommended Operating Conditions (General Characteristics)

PARAMETER	MIN	TYP	MAX	UNIT	CONDITION
Voltage supply range	2.0		3.6	V	All supply pins must have the same voltage
Voltage on digital inputs	0		VDD	V	
Temperature range	-40		85	°C	Ambient

### 4.4 Thermal Resistance Characteristics for RHB Package

	°C/W <sup>(1)</sup>	AIR FLOW (m/s) <sup>(2)</sup>
$R\theta_{JC}$ Junction-to-case (top)	21.1	0.00
$R\theta_{JB}$ Junction-to-board	5.3	0.00
$R\theta_{JA}$ Junction-to-free air	31.3	0.00
$Ps_{JT}$ Junction-to-package top	0.2	0.00
$Ps_{JB}$ Junction-to-board	5.3	0.00
$R\theta_{JC}$ Junction-to-case (bottom)	0.8	0.00

- These values are based on a JEDEC-defined 2S2P system (with the exception of the Theta JC [ $R\theta_{JC}$ ] value, which is based on a JEDEC-defined 1S0P system) and will change based on environment as well as application. For more information, see these EIA/JEDEC standards:
  - JESD51-2, *Integrated Circuits Thermal Test Method Environmental Conditions - Natural Convection (Still Air)*
  - JESD51-3, *Low Effective Thermal Conductivity Test Board for Leaded Surface Mount Packages*
  - JESD51-7, *High Effective Thermal Conductivity Test Board for Leaded Surface Mount Packages*
  - JESD51-9, *Test Boards for Area Array Surface Mount Package Thermal Measurements*
Power dissipation of 40 mW and an ambient temperature of 25°C is assumed.
- m/s = meters per second

## 4.5 RF Characteristics

PARAMETER	MIN	TYP	MAX	UNIT	CONDITION
Frequency bands	820		950	MHz	Contact TI for more information about the use of these frequency bands.
	410		475	MHz	
	164		190	MHz	
	(274)		(316.6)	MHz	
	(205)		(237.5)	MHz	
	(137)		(158.3)	MHz	
Frequency resolution		30		Hz	In 820–950 MHz band
		15		Hz	In 410–475 MHz band
		6		Hz	In 164–190 MHz band
Data rate	0		1250	kbps	Packet mode
	0		625	kbps	Transparent mode

## 4.6 Regulatory Standards

PERFORMANCE MODE	FREQUENCY BAND	SUITABLE FOR COMPLIANCE WITH	COMMENTS
High-performance mode	820–950 MHz	ARIB STD-T108 ETSI EN 300 220 receiver, categories 2 and 3 FCC Part 15.247 FCC Part 15.249 FCC Part 90 Mask G FCC Part 90 Mask J	Performance also suitable for systems targeting maximum allowed output power in the respective bands, using a range extender such as the CC1190 device
	410–475 MHz	ARIB STD-T67 ARIB RCR STD-T30 ETSI EN 300 220 receiver, categories 2 and 3 FCC Part 90 Mask D FCC Part 90 Mask G	Performance also suitable for systems targeting maximum allowed output power in the respective bands, using a range extender
	164–190 MHz	ETSI EN 300 220 receiver, category 1 FCC Part 90 Mask D	Performance also suitable for systems targeting maximum allowed output power in the respective bands, using a range extender
Low-power mode	820–950 MHz	ETSI EN 300 220 receiver, categories 2 and 3 FCC Part 15.247 FCC Part 15.249	
	410–475 MHz	ETSI EN 300 220 receiver, categories 2 and 3	
	164–190 MHz	ETSI EN 300 220	



## 4.7 Current Consumption, Static Modes

 $T_A = 25^\circ\text{C}$ , VDD = 3.0 V if nothing else stated

PARAMETER	MIN	TYP	MAX	UNIT	CONDITION
Power down with retention		0.12	1	$\mu\text{A}$	
		0.5		$\mu\text{A}$	Low-power RC oscillator running
XOFF mode		180		$\mu\text{A}$	Crystal oscillator / TCXO disabled
IDLE mode		1.5		mA	Clock running, system waiting with no radio activity

## 4.8 Current Consumption, Transmit Modes

### 4.8.1 868-, 915-, and 920-MHz Bands (High-Performance Mode)

 $T_A = 25^\circ\text{C}$ , VDD = 3.0 V if nothing else stated

PARAMETER	MIN	TYP	MAX	UNIT	CONDITION
TX current consumption +14 dBm		46		mA	
TX current consumption +10 dBm		36		mA	

### 4.8.2 433-MHz Band (High-Performance Mode)

 $T_A = 25^\circ\text{C}$ , VDD = 3.0 V if nothing else stated

PARAMETER	MIN	TYP	MAX	UNIT	CONDITION
TX current consumption +15 dBm		49		mA	
TX current consumption +14 dBm		46		mA	
TX current consumption +10 dBm		35		mA	

### 4.8.3 169-MHz Band (High-Performance Mode)

 $T_A = 25^\circ\text{C}$ , VDD = 3.0 V if nothing else stated

PARAMETER	MIN	TYP	MAX	UNIT	CONDITION
TX current consumption +15 dBm		54		mA	
TX current consumption +14 dBm		50		mA	
TX current consumption +10 dBm		39		mA	

### 4.8.4 Low-Power Mode

 $T_A = 25^\circ\text{C}$ , VDD = 3.0 V,  $f_c = 869.5\text{ MHz}$  if nothing else stated

PARAMETER	MIN	TYP	MAX	UNIT	CONDITION
TX current consumption +10 dBm		33.6		mA	

## 4.9 Current Consumption, Receive Modes

### 4.9.1 High-Performance Mode

$T_A = 25^\circ\text{C}$ ,  $V_{DD} = 3.0\text{ V}$ ,  $f_c = 869.5\text{ MHz}$  if nothing else stated

PARAMETER	MIN	TYP	MAX	UNIT	CONDITION
RX Wait for sync					
1.2 kbps, 4-byte preamble (50 kHz Channel Filter Bandwidth)		0.5		mA	Using RX sniff mode, where the receiver wakes up at regular intervals looking for an incoming packet. Sniff mode configured to terminate on Carrier Sense, and is measured using <code>RSSI_VALID_COUNT = 1</code> (0 for 1.2 kbps with 50 kHz Channel Filter Bandwidth), <code>AGC_WIN_SIZE = 0</code> , and <code>SETTLE_WAIT = 1</code> . <sup>(1)</sup>
1.2 kbps, 3-byte preamble (11 kHz Channel Filter Bandwidth)		3.1		mA	
38.4 kbps, 12-byte preamble		3.4		mA	
50 kbps, 24-byte preamble		2.1		mA	
RX Peak Current					
1.2kbps		23.5		mA	Peak current consumption during packet reception
Average current consumption Check for data packet every 1 second using Wake on Radio		8		$\mu\text{A}$	50 kbps, 5-byte preamble, 40-kHz RC oscillator used as sleep timer

(1) See the sniff mode design note for more information ([SWRA428](#)).

### 4.9.2 Low-Power Mode

$T_A = 25^\circ\text{C}$ ,  $V_{DD} = 3.0\text{ V}$ ,  $f_c = 869.5\text{ MHz}$  if nothing else stated

PARAMETER	MIN	TYP	MAX	UNIT	CONDITION
RX Peak Current Low-power RX mode					
1.2 kbps		19		mA	Peak current consumption during packet reception at the sensitivity limit

## 4.10 Receive Parameters

All RX measurements made at the antenna connector, to a bit error rate (BER) limit of 1%. Selectivity and blocking is measured with the desired signal 3 dB greater than the sensitivity level.

### 4.10.1 General Receive Parameters (High-Performance Mode)

$T_A = 25^\circ\text{C}$ ,  $V_{DD} = 3.0\text{ V}$ ,  $f_c = 869.5\text{ MHz}$  if nothing else stated

PARAMETER	MIN	TYP	MAX	UNIT	CONDITION
Saturation		+10		dBm	
Digital channel filter programmable bandwidth	9.5		1600	kHz	
IIP3		-14		dBm	At maximum gain
Data rate offset tolerance		$\pm 14$ $\pm 1600$		% ppm	With carrier sense detection enabled With carrier sense detection disabled
Spurious emissions					
1–13 GHz (VCO leakage at 3.5 GHz)		< -56		dBm	Radiated emissions measured according to ETSI EN 300 220, $f_c = 869.5\text{ MHz}$
30 MHz to 1 GHz		< -57		dBm	
Optimum source impedance					
868-, 915-, and 920-MHz bands		$60 + j60 / 30 + j30$		$\Omega$	(Differential or single-ended RX configurations)
433-MHz band		$100 + j60 / 50 + j30$		$\Omega$	
169-MHz band		$140 + j40 / 70 + j20$		$\Omega$	

#### 4.10.2 RX Performance in 868-, 915-, and 920-MHz Bands (High-Performance Mode)

 $T_A = 25^\circ\text{C}$ , VDD = 3.0 V if nothing else stated

PARAMETER	MIN	TYP	MAX	UNIT	CONDITION
Sensitivity		-122		dBm	1.2 kbps 2-FSK, DEV=4 kHz CHF=11 kHz <sup>(1)</sup>
		-113		dBm	4.8 kbps OOK
		-108		dBm	32.768 kbps 2-GFSK, DEV=50 kHz CHF=208 kHz <sup>(1)</sup>
		-110		dBm	38.4 kbps 2-GFSK, DEV=20 kHz CHF=104 kHz <sup>(1)</sup>
		-109		dBm	50 kbps 2-GFSK, DEV=25 kHz, CHF=104 kHz <sup>(1)</sup>
		-107		dBm	100-kbps 2-GFSK, DEV=50 kHz, CHF=208 kHz <sup>(1)</sup>
		-97		dBm	500 kbps 2-GMSK, CHF=833 kHz <sup>(1)</sup>
Blocking and Selectivity 1.2-kbps 2-FSK, 12.5-kHz channel separation, 4-kHz deviation, 11-kHz channel filter		54		dB	± 12.5 kHz (adjacent channel)
		55		dB	± 25 kHz (alternate channel)
		77		dB	± 2 MHz
		82		dB	± 10 MHz
Blocking and Selectivity 32.768-kbps 2-GFSK, 200-kHz channel separation, 50-kHz deviation, 208-kHz channel filter		38		dB	± 200 kHz
		46		dB	± 400 kHz
		66		dB	± 2 MHz
		70		dB	± 10 MHz
Blocking and Selectivity 38.4-kbps 2-GFSK, 100-kHz channel separation, 20-kHz deviation, 104-kHz channel filter		44		dB	+ 100 kHz (adjacent channel)
		44		dB	± 200 kHz (alternate channel)
		64		dB	± 2 MHz
		72		dB	± 10 MHz
Blocking and Selectivity 50-kbps 2-GFSK, 200-kHz channel separation, 25-kHz deviation, 104-kHz channel filter (Same modulation format as 802.15.4g Mandatory Mode)		41		dB	± 200 kHz (adjacent channel)
		46		dB	± 400 kHz (alternate channel)
		65		dB	± 2 MHz
		71		dB	± 10 MHz
Blocking and Selectivity 100-kbps 2-GFSK, 50-kHz deviation, 208-kHz channel filter		45		dB	± 400 kHz (adjacent channel)
		54		dB	± 800 kHz (alternate channel)
		63		dB	± 2 MHz
		68		dB	± 10 MHz
Blocking and Selectivity 500-kbps GMSK, 833-kHz channel filter		42		dB	+ 1 MHz (adjacent channel)
		42		dB	± 2 MHz (alternate channel)
		57		dB	± 10 MHz
Blocking and Selectivity 1-Mbps 4-GFSK, 400-kHz deviation, 1.6-MHz channel filter		46		dB	± 2 MHz (adjacent channel)
		52		dB	± 4 MHz (alternate channel)
		59		dB	± 10 MHz
Image rejection (Image compensation enabled)		56		dB	1.2 kbps, DEV=4 kHz, CHF=10 kHz, image at -125 kHz

(1) DEV is short for deviation, CHF is short for Channel Filter Bandwidth

### 4.10.3 RX Performance in 433-MHz Band (High-Performance Mode)

$T_A = 25^\circ\text{C}$ ,  $V_{DD} = 3.0\text{ V}$  if nothing else stated

PARAMETER	MIN	TYP	MAX	UNIT	CONDITION
Sensitivity		-123		dBm	1.2 kbps 2-FSK, DEV=4 kHz CHF=11 kHz <sup>(1)</sup>
		-111		dBm	38.4 kbps 2-GFSK, DEV=20 kHz CHF=104 kHz <sup>(1)</sup>
Blocking and Selectivity 1.2-kbps 2-FSK, 12.5-kHz channel separation, 4-kHz deviation, 11-kHz channel filter		60		dB	± 12.5 kHz (adjacent channel)
		61		dB	± 25 kHz (alternate channel)
		82		dB	± 2 MHz
		85		dB	± 10 MHz
Blocking and Selectivity 38.4-kbps 2-GFSK, 100-kHz channel separation, 20-kHz deviation, 104-kHz channel filter		49		dB	+ 100 kHz (adjacent channel)
		48		dB	± 200 kHz (alternate channel)
		66		dB	± 2 MHz
		74		dB	± 10 MHz

(1) DEV is short for deviation, CHF is short for Channel Filter Bandwidth

### 4.10.4 RX Performance in 169-MHz Band (High-Performance Mode)

$T_A = 25^\circ\text{C}$ ,  $V_{DD} = 3.0\text{ V}$  if nothing else stated

PARAMETER	MIN	TYP	MAX	UNIT	CONDITION
Sensitivity		-122		dBm	1.2 kbps 2-FSK, DEV=4 kHz CHF=11 kHz <sup>(1)</sup>
Blocking and Selectivity 1.2 kbps 2-FSK, 12.5-kHz channel separation, 4-kHz deviation, 11-kHz channel filter		59		dB	± 12.5 kHz (adjacent channel)
		64		dB	± 25 kHz (alternate channel)
		84		dB	± 2 MHz
		86		dB	± 10 MHz
Spurious response rejection 1.2 kbps 2-FSK, 12.5-kHz channel separation, 4-kHz deviation, 11-kHz channel filter		68		dB	Spurious at ± 40 MHz from carrier
Image rejection (Image compensation enabled)		68		dB	1.2 kbps, DEV=4 kHz, CHF=10 kHz, image at -125 kHz

(1) DEV is short for deviation, CHF is short for Channel Filter Bandwidth

### 4.10.5 RX Performance in Low-Power Mode

$T_A = 25^\circ\text{C}$ ,  $V_{DD} = 3.0\text{ V}$ ,  $f_c = 869.5\text{ MHz}$  if nothing else stated

PARAMETER	MIN	TYP	MAX	UNIT	CONDITION
Sensitivity		-110		dBm	1.2 kbps 2-FSK, DEV=4 kHz CHF=11 kHz <sup>(1)</sup>
		-96		dBm	50 kbps 2-GFSK, DEV=25 kHz, CHF=119 kHz <sup>(1)</sup>
Blocking and Selectivity 50 kbps 2-GFSK, 200-kHz channel separation, 25-kHz deviation, 104-kHz channel filter (Same modulation format as 802.15.4g Mandatory Mode)		41		dB	+ 200 kHz (adjacent channel)
		45		dB	+ 400 kHz (alternate channel)
		62		dB	± 2 MHz
		60		dB	± 10 MHz
Saturation		+10		dBm	

(1) DEV is short for deviation, CHF is short for Channel Filter Bandwidth

## 4.11 Transmit Parameters

 $T_A = 25^\circ\text{C}$ ,  $V_{DD} = 3.0\text{ V}$ ,  $f_c = 869.5\text{ MHz}$  if nothing else stated

PARAMETER	MIN	TYP	MAX	UNIT	CONDITION	
Max output power		+14		dBm	At 915- and 920-MHz	
		+15		dBm	At 915- and 920-MHz with $V_{DD} = 3.6\text{ V}$	
		+15		dBm	At 868 MHz	
		+16		dBm	At 868 MHz with $V_{DD} = 3.6\text{ V}$	
		+15		dBm	At 433 MHz	
		+16		dBm	At 433 MHz with $V_{DD} = 3.6\text{ V}$	
Min output power		-12		dBm	Within fine step size range	
		-38		dBm	Within coarse step size range	
Output power step size		0.4		dB	Within fine step size range	
Adjacent channel power		-60		dBc	4-GFSK 9.6 kbps in 12.5-kHz channel, measured in 8.75-kHz bandwidth (ETSI 300 220 compliant)	
Spurious emissions (Excluding harmonics)					Transmission at +14 dBm Suitable for systems targeting compliance with ETSI EN 300 220, ETSI EN 54-25, FCC Part 15, FCC Part 90, ARIB STD-T108, ARIB STD-T67, ARIB RCR STD-30 Measured in 1-MHz bandwidth	
30 MHz–1 GHz		< -57		dBm		
1–12.75 GHz		< -50		dBm		
Harmonics						
Second Harm, 169 MHz (ETSI)		-43		dBm	Transmission at +14 dBm (or maximum allowed in applicable band where this is less than +14 dBm) using TI reference design  Suitable for systems targeting compliance with ETSI EN 300-220, ETSI EN 54-25, FCC Part 15, FCC Part 90, ARIB STD-T108, ARIB STD-T67, ARIB RCR STD-30	
Third Harm, 169 MHz (ETSI)		-57		dBm		
Fourth Harm, 169 MHz (ETSI)		-63		dBm		
Second Harm, 433 MHz (ETSI)		-59		dBm		
Third Harm, 433 MHz (ETSI)		-51		dBm		
Fourth Harm, 433 MHz (ETSI)		-63		dBm		
Second Harm, 868 MHz (ETSI)		-50		dBm		
Third Harm, 868 MHz (ETSI)		-44		dBm		
Fourth Harm, 868 MHz (ETSI)		-56		dBm		
Second Harm, 915 MHz (FCC)		-58		dBm		
Third Harm, 915 MHz (FCC)		-46		dBm		
Fourth Harm, 915 MHz (FCC)		-62		dBm		
Second Harm, 920 MHz (ARIB)		-65		dBm		
Third Harm, 920 MHz (ARIB)		-60		dBm		
Optimum load impedance						
868-, 915-, and 920-MHz bands		35 + j35		$\Omega$		
433-MHz band		55 + j25		$\Omega$		
169-MHz band		80 + j0		$\Omega$		

## 4.12 PLL Parameters

### 4.12.1 High-Performance Mode

$T_A = 25^\circ\text{C}$ ,  $V_{DD} = 3.0\text{ V}$  if nothing else stated

PARAMETER	MIN	TYP	MAX	UNIT	CONDITION
Phase noise in 868-, 915-, and 920-MHz bands 200-kHz loop bandwidth setting		-94		dBc/Hz	$\pm 10\text{ kHz offset}$
		-96		dBc/Hz	$\pm 100\text{ kHz offset}$
		-123		dBc/Hz	$\pm 1\text{ MHz offset}$
		-137		dBc/Hz	$\pm 10\text{ MHz offset}$
Phase noise in 868-, 915-, and 920-MHz bands 300-kHz loop bandwidth setting		-100		dBc/Hz	$\pm 10\text{ kHz offset}$
		-102		dBc/Hz	$\pm 100\text{ kHz offset}$
		-121		dBc/Hz	$\pm 1\text{ MHz offset}$
Phase noise in 868-, 915-, and 920-MHz bands 400-kHz loop bandwidth setting		-103		dBc/Hz	$\pm 10\text{ kHz offset}$
		-104		dBc/Hz	$\pm 100\text{ kHz offset}$
		-119		dBc/Hz	$\pm 1\text{ MHz offset}$
Phase noise in 868-, 915-, and 920-MHz bands 500-kHz loop bandwidth setting		-133		dBc/Hz	$\pm 10\text{ MHz offset}$
		-104		dBc/Hz	$\pm 10\text{ kHz offset}$
		-106		dBc/Hz	$\pm 100\text{ kHz offset}$
Phase noise in 868-, 915-, and 920-MHz bands 500-kHz loop bandwidth setting		-116		dBc/Hz	$\pm 1\text{ MHz offset}$
		-130		dBc/Hz	$\pm 10\text{ MHz offset}$
	Phase noise in 433-MHz band 300-kHz loop bandwidth setting		-106		dBc/Hz
		-107		dBc/Hz	$\pm 100\text{ kHz offset}$
		-127		dBc/Hz	$\pm 1\text{ MHz offset}$
		-141		dBc/Hz	$\pm 10\text{ MHz offset}$
Phase noise in 169-MHz band 300-kHz loop bandwidth setting		-114		dBc/Hz	$\pm 10\text{ kHz offset}$
		-114		dBc/Hz	$\pm 100\text{ kHz offset}$
		-132		dBc/Hz	$\pm 1\text{ MHz offset}$
	-142		dBc/Hz	$\pm 10\text{ MHz offset}$	

### 4.12.2 Low-Power Mode

$T_A = 25^\circ\text{C}$ ,  $V_{DD} = 3.0\text{ V}$  if nothing else stated

PARAMETER	MIN	TYP	MAX	UNIT	CONDITION
Phase noise in 868-, 915-, and 920-MHz bands 200-kHz loop bandwidth setting		-99		dBc/Hz	$\pm 10\text{ kHz offset}$
		-101		dBc/Hz	$\pm 100\text{ kHz offset}$
		-121		dBc/Hz	$\pm 1\text{ MHz offset}$
		-135		dBc/Hz	$\pm 10\text{ MHz offset}$

### 4.13 Wake-up and Timing

 $T_A = 25^\circ\text{C}$ ,  $V_{DD} = 3.0\text{ V}$ ,  $f_c = 869.5\text{ MHz}$  if nothing else stated

The turnaround behavior to and from RX and/or TX is highly configurable, and the time it takes will depend on how the device is set up. See the CC120X user guide ([SWRU346](#)) for more information.

PARAMETER	MIN	TYP	MAX	UNIT	CONDITION
Powerdown to IDLE		0.24		ms	Depends on crystal
IDLE to RX/TX		133		$\mu\text{s}$	Calibration disabled
		369		$\mu\text{s}$	Calibration enabled
RX/TX turnaround		43		$\mu\text{s}$	
RX-to-RX turnaround		369		$\mu\text{s}$	With PLL calibration
		0		$\mu\text{s}$	Without PLL calibration
TX-to-TX turnaround		369		$\mu\text{s}$	With PLL calibration
		0		$\mu\text{s}$	Without PLL calibration
RX/TX to IDLE time		237		$\mu\text{s}$	Calibrate when leaving RX/TX enabled
		0		$\mu\text{s}$	Calibrate when leaving RX/TX disabled
Frequency synthesizer calibration		314		$\mu\text{s}$	When using SCAL strobe
Minimum required number of preamble bytes		0.5		bytes	Required for RF front-end gain settling only. Digital demodulation does not require preamble for settling.
Time from start RX until valid RSSI <sup>(1)</sup> Including gain settling (function of channel bandwidth. Programmable for trade-off between speed and accuracy)		4.2		ms	12.5-kHz channels
		0.25		ms	120-kHz channels

(1) See the design note on RSSI and response time. It is written for the CC112X devices, but the same principles apply for the CC1200 device.

### 4.14 40-MHz Crystal Oscillator

 $T_A = 25^\circ\text{C}$ ,  $V_{DD} = 3.0\text{ V}$  if nothing else stated

PARAMETER	MIN	TYP	MAX	UNIT	CONDITION
Crystal frequency	38.4		40	MHz	It is expected that there will be degraded sensitivity at multiples of XOSC/2 in RX, and an increase in spurious emissions when the RF channel is close to multiples of XOSC in TX. We recommend that the RF channel is kept $RX\_BW/2$ away from XOSC/2 in RX, and that the level of spurious emissions be evaluated if the RF channel is closer than 1 MHz to multiples of XOSC in TX.
Load capacitance ( $C_L$ )		10		pF	
ESR			60	$\Omega$	Simulated over operating conditions
Start-up time		0.24		ms	Depends on crystal

### 4.15 40-MHz Clock Input (TCXO)

 $T_A = 25^\circ\text{C}$ ,  $V_{DD} = 3.0\text{ V}$  if nothing else stated

PARAMETER	MIN	TYP	MAX	UNIT	CONDITION
Clock frequency	38.4		40	MHz	
TCXO with CMOS output					TCXO with CMOS output directly coupled to pin EXT_OSC
High input voltage	1.4		$V_{DD}$	V	
Low input voltage	0		0.6	V	
Rise / Fall time			2	ns	
Clipped sine output					TCXO clipped sine output connected to pin EXT_OSC through series capacitor
Clock input amplitude (peak-to-peak)	0.8		1.5	V	

#### 4.16 32-kHz Clock Input

$T_A = 25^\circ\text{C}$ ,  $V_{DD} = 3.0\text{ V}$  if nothing else stated

PARAMETER	MIN	TYP	MAX	UNIT	CONDITION
Clock frequency		32		kHz	
32-kHz clock input pin input high voltage	$0.8 \times V_{DD}$			V	
32-kHz clock input pin input low voltage			$0.2 \times V_{DD}$	V	

#### 4.17 40-kHz RC Oscillator

$T_A = 25^\circ\text{C}$ ,  $V_{DD} = 3.0\text{ V}$  if nothing else stated

PARAMETER	MIN	TYP	MAX	UNIT	CONDITION
Frequency		40		kHz	After calibration (frequency calibrated against the 40-MHz crystal or TCXO)
Frequency accuracy after calibration		$\pm 0.1$		%	Relative to frequency reference (that is, 40-MHz crystal or TCXO)
Initial calibration time		1.32		ms	

#### 4.18 I/O and Reset

$T_A = 25^\circ\text{C}$ ,  $V_{DD} = 3.0\text{ V}$  if nothing else stated

PARAMETER	MIN	TYP	MAX	UNIT	CONDITION
Logic input high voltage	$0.8 \times V_{DD}$			V	
Logic input low voltage			$0.2 \times V_{DD}$	V	
Logic output high voltage	$0.8 \times V_{DD}$			V	At 4-mA output load or less
Logic output low voltage			$0.2 \times V_{DD}$	V	
Power-on reset threshold		1.3		V	Voltage on DVDD pin

#### 4.19 Temperature Sensor

$T_A = 25^\circ\text{C}$ ,  $V_{DD} = 3.0\text{ V}$  if nothing else stated

PARAMETER	MIN	TYP	MAX	UNIT	CONDITION
Temperature sensor range	-40		85	$^\circ\text{C}$	
Temperature coefficient		2.66		$\text{mV} / ^\circ\text{C}$	Change in sensor output voltage versus change in temperature
Typical output voltage		794		mV	Typical sensor output voltage at $T_A = 25^\circ\text{C}$ , $V_{DD} = 3.0\text{ V}$
VDD coefficient		1.17		$\text{mV} / \text{V}$	Change in sensor output voltage versus change in VDD

The CC1200 device can be configured to provide a voltage proportional to temperature on GPIO1. The temperature can be estimated by measuring this voltage (see [Section 4.19, Temperature Sensor](#)). For more information, see the temperature sensor design note ([SWRA415](#)).



## 4.20 Typical Characteristics

T<sub>A</sub> = 25°C, VDD = 3.0 V, f<sub>c</sub> = 869.5 MHz if nothing else stated

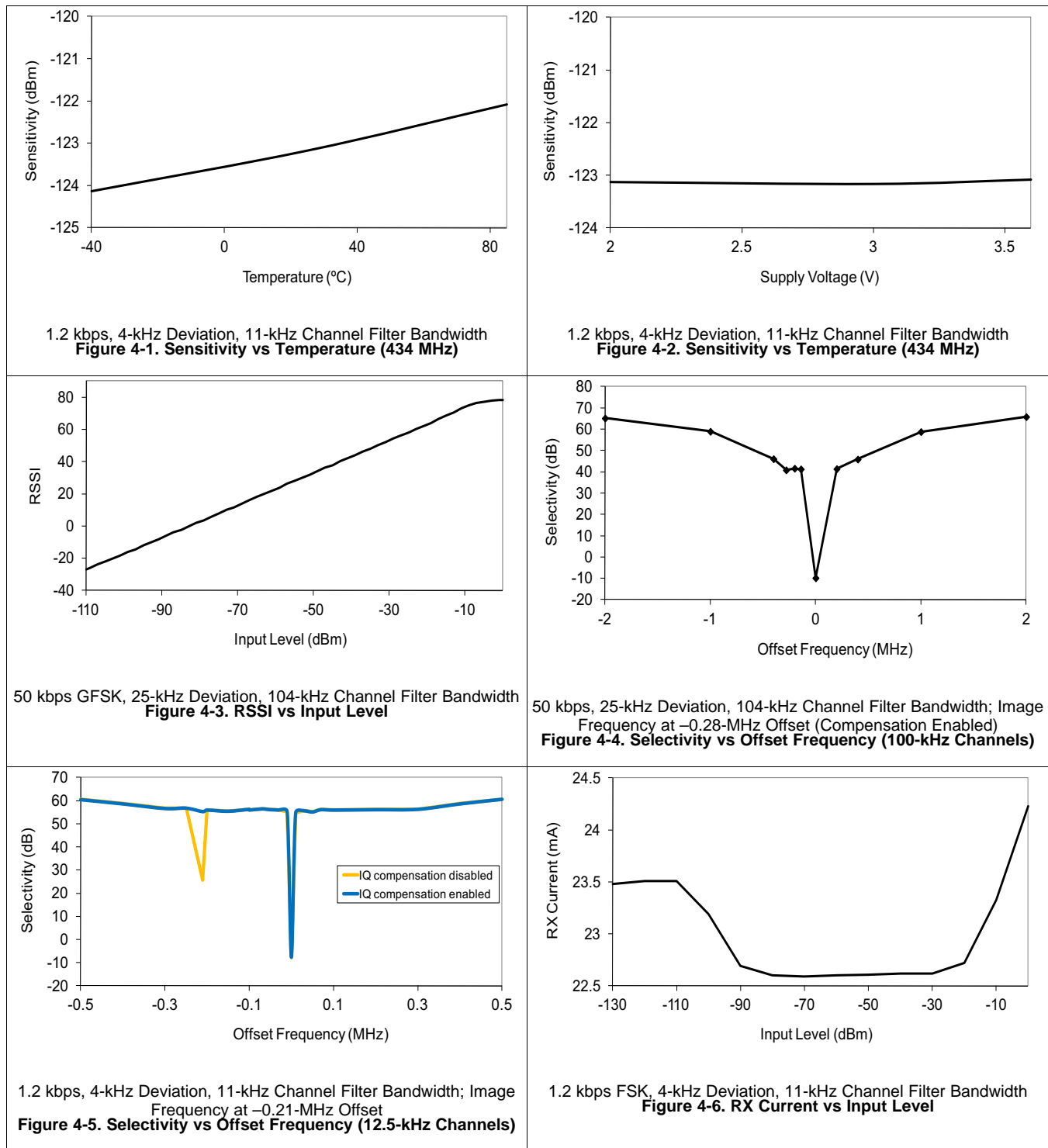

Typical Characteristics (continued)

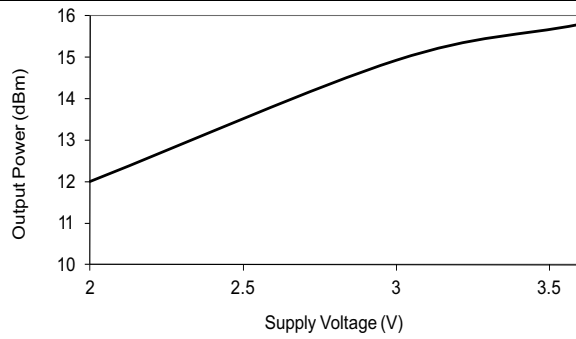

Maximum Output Power Setting (0x7F)  
**Figure 4-7. Output Power vs Supply Voltage**

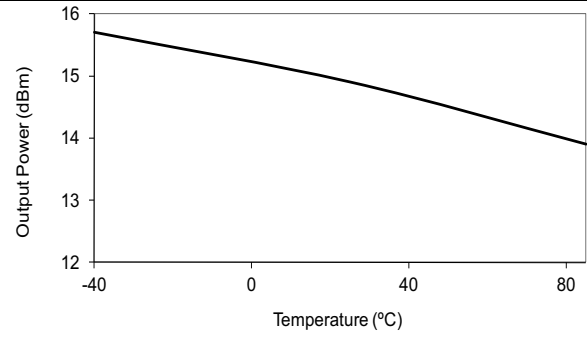

Maximum Power Setting (0x7F)  
**Figure 4-8. Output Power vs Temperature**

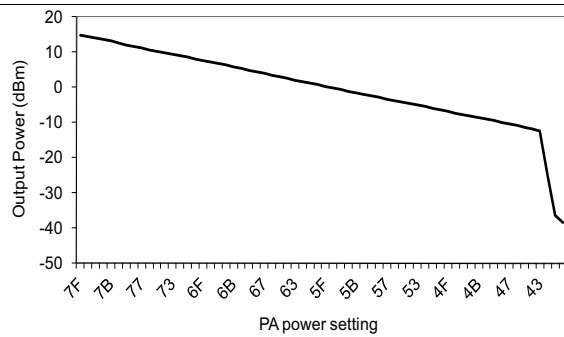

**Figure 4-9. Output Power at 868 MHz PA Power Setting**

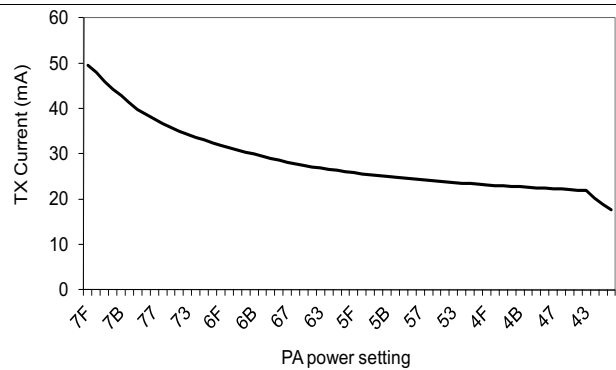

**Figure 4-10. TX Current at 868 MHz vs PA Power Setting**

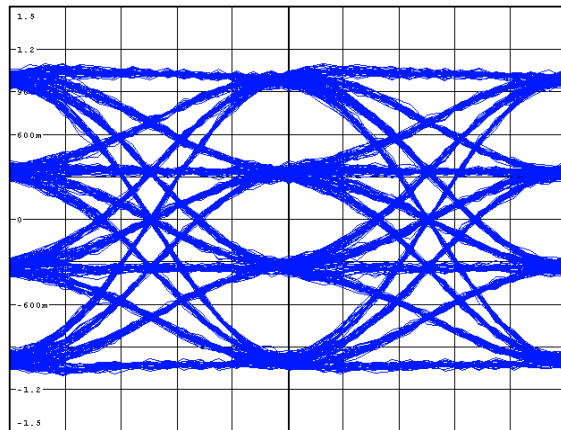

1 Mbps 4-GFSK, 400-kHz Deviation, 500-kHz Loop Bandwidth  
**Figure 4-11. Eye Diagram**

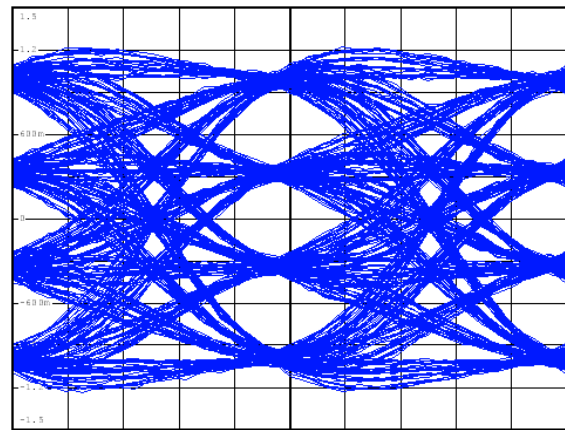

1 Mbps 4-GFSK, 400-kHz Deviation, 300-kHz Loop Bandwidth  
**Figure 4-12. Eye Diagram**

Typical Characteristics (continued)

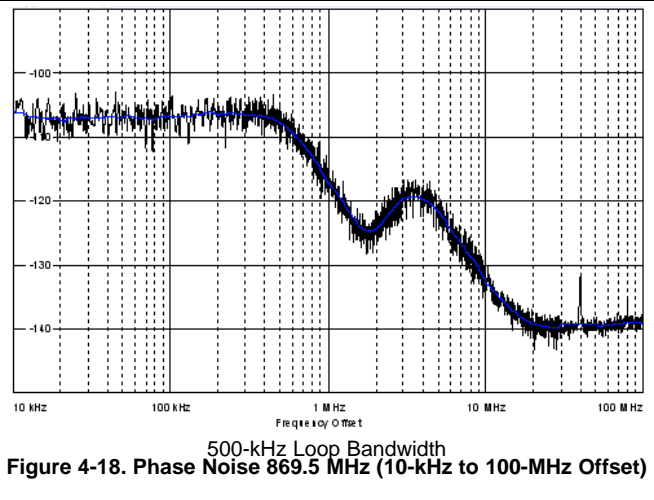
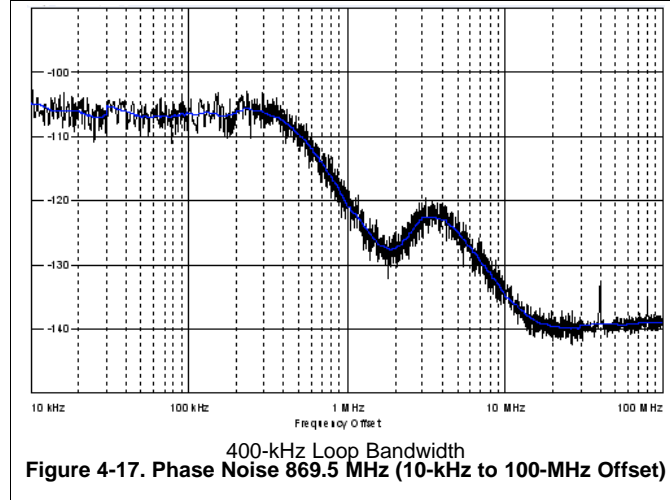
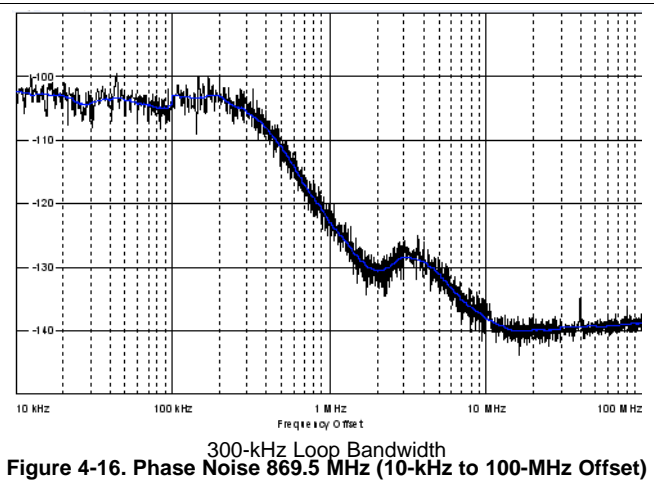
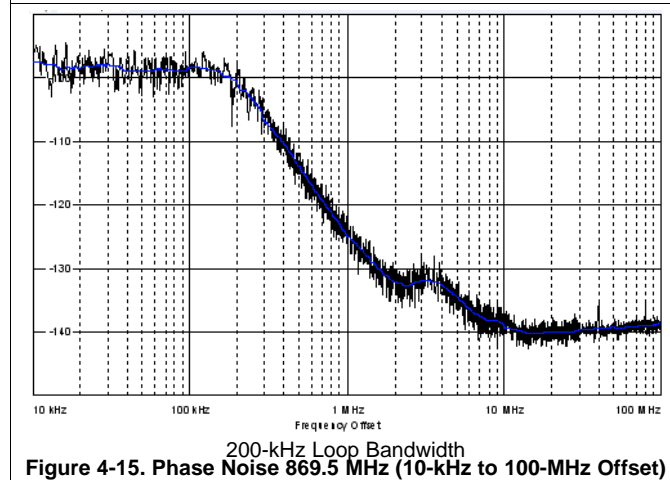
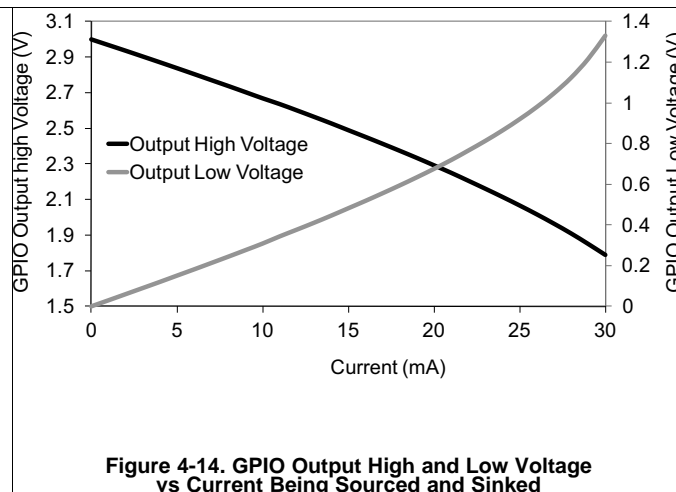
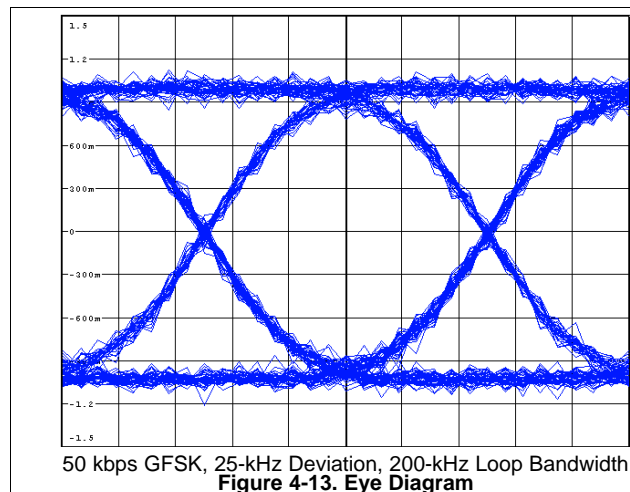

## 5 Detailed Description

### 5.1 Block Diagram

Figure 5-1 shows the system block diagram of the CC120x family of devices.

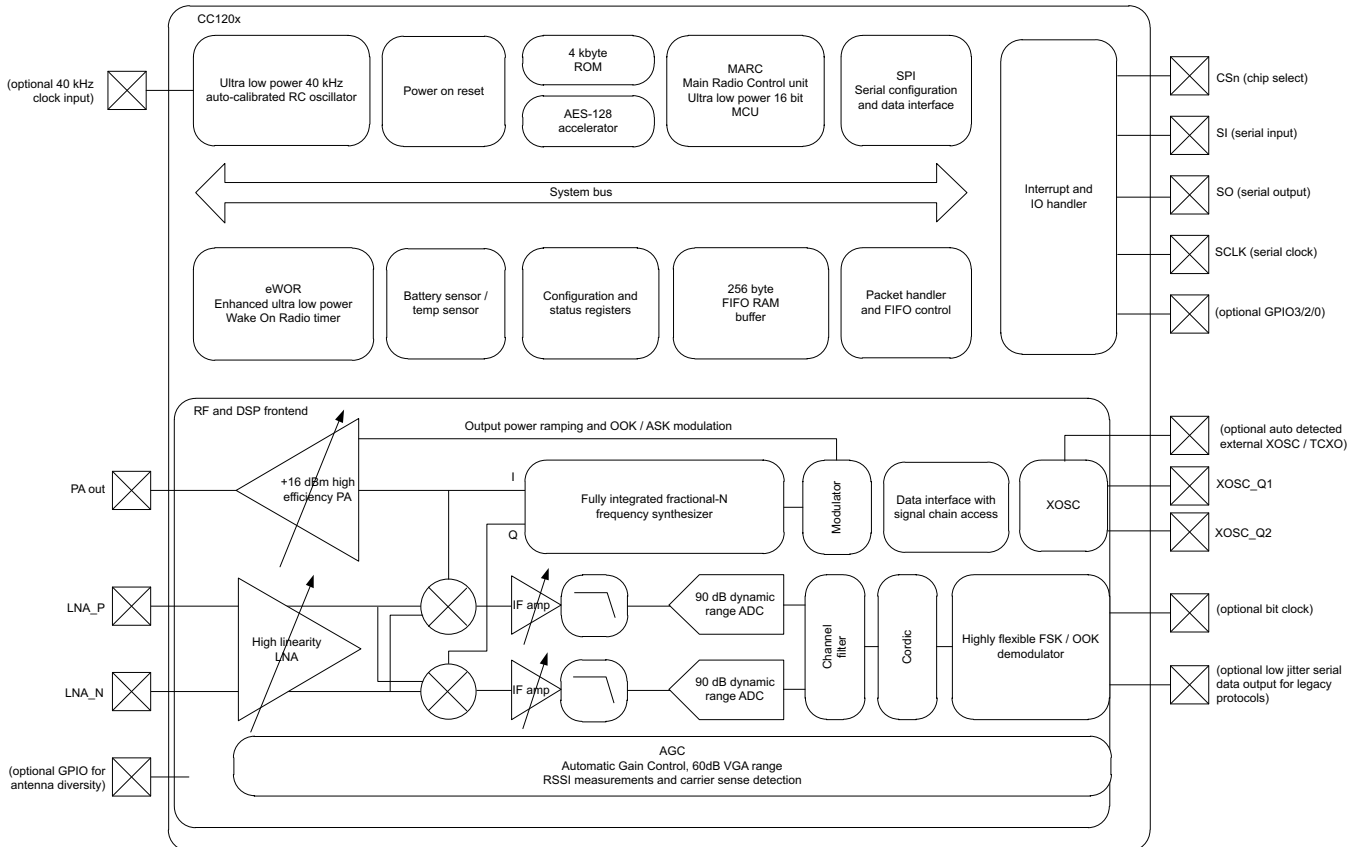

Figure 5-1. System Block Diagram

### 5.2 Frequency Synthesizer

At the center of the CC1200 device there is a fully integrated, fractional-N, ultra-high-performance frequency synthesizer. The frequency synthesizer is designed for excellent phase noise performance, providing very high selectivity and blocking performance. The system is designed to comply with the most stringent regulatory spectral masks at maximum transmit power.

Either a crystal can be connected to XOSC\_Q1 and XOSC\_Q2, or a TCXO can be connected to the EXT\_XOSC input. The oscillator generates the reference frequency for the synthesizer, as well as clocks for the analog-to-digital converter (ADC) and the digital part. To reduce system cost, the CC1200 device has high-accuracy frequency estimation and compensation registers to measure and compensate for crystal inaccuracies. This compensation enables the use of lower cost crystals. If a TCXO is used, the CC1200 device automatically turns on and off the TCXO when needed to support low-power modes and Wake-On-Radio operation.

### 5.3 Receiver

The CC1200 device features a highly flexible receiver. The received RF signal is amplified by the low-noise amplifier (LNA) and is down-converted in quadrature (I/Q) to the intermediate frequency (IF). At IF, the I/Q signals are digitized by the high dynamic-range ADCs.

An advanced automatic gain control (AGC) unit adjusts the front-end gain, and enables the CC1200 device to receive strong and weak signals, even in the presence of strong interferers. High-attenuation channels and data filtering enable reception with strong neighbor channel interferers. The I/Q signal is converted to a phase and magnitude signal to support the FSK and OOK modulation schemes.

---

#### NOTE

A unique I/Q compensation algorithm removes any problem of I/Q mismatch, thus avoiding time-consuming and costly I/Q image calibration steps.

---

### 5.4 Transmitter

The CC1200 transmitter is based on direct synthesis of the RF frequency (in-loop modulation). To use the spectrum effectively, the CC1200 device has extensive data filtering and shaping in TX mode to support high throughput data communication in narrowband channels. The modulator also controls power ramping to remove issues such as spectral splattering when driving external high-power RF amplifiers.

### 5.5 Radio Control and User Interface

The CC1200 digital control system is built around the main radio control (MARC), which is implemented using an internal high-performance, 16-bit ultra-low-power processor. MARC handles power modes, radio sequencing, and protocol timing.

A 4-wire SPI serial interface is used for configuration and data buffer access. The digital baseband includes support for channel configuration, packet handling, and data buffering. The host MCU can stay in power-down mode until a valid RF packet is received. This greatly reduces power consumption. When the host MCU receives a valid RF packet, it burst-reads the data. This reduces the required computing power.

The CC1200 radio control and user interface are based on the widely used CC1101 transceiver. This relationship enables an easy transition between the two platforms. The command strobes and the main radio states are the same for the two platforms.

For legacy formats, the CC1200 device also supports two serial modes.

- Synchronous serial mode: The CC1200 device performs bit synchronization and provides the MCU with a bit clock with associated data.
- Transparent mode: The CC1200 device outputs the digital baseband signal using a digital interpolation filter to eliminate jitter introduced by digital filtering and demodulation.

### 5.6 Enhanced Wake-On-Radio (eWOR)

eWOR, using a flexible integrated sleep timer, enables automatic receiver polling with no intervention from the MCU. When the CC1200 device enters RX mode, it listens and then returns to sleep if a valid RF packet is not received. The sleep interval and duty cycle can be configured to make a trade-off between network latency and power consumption. Incoming messages are time-stamped to simplify timer re-synchronization.

The eWOR timer runs off an ultra-low-power RC oscillator. To improve timing accuracy, the RC oscillator can be automatically calibrated to the RF crystal in configurable intervals.

## 5.7 RX Sniff Mode

The CC1200 device supports quick start up times, and requires few preamble bits. RX Sniff Mode uses these conditions to dramatically reduce the current consumption while the receiver is waiting for data.

Because the CC1200 device can wake up and settle much faster than the duration of most preambles, it is not required to be in RX mode continuously while waiting for a packet to arrive. Instead, the enhanced Wake-On-Radio feature can be used to put the device into sleep mode periodically. By setting an appropriate sleep time, the CC1200 device can wake up and receive the packet when it arrives with no performance loss. This sequence removes the need for accurate timing synchronization between transmitter and receiver, and lets the user trade off current consumption between the transmitter and receiver.

For more information, see the RX Sniff Mode design note ([SWRA428](#)).

## 5.8 Antenna Diversity

Antenna diversity can increase performance in a multipath environment. An external antenna switch is required. The CC1200 device uses one of the GPIO pins to automatically control the switch. This device also supports differential output control signals typically used in RF switches.

If antenna diversity is enabled, the GPIO alternates between high and low states until a valid RF input signal is detected. An optional acknowledge packet can be transmitted without changing the state of the GPIO.

An incoming RF signal can be validated by received signal strength or by using the automatic preamble detector. Using the automatic preamble detector ensures a more robust system and avoids the need to set a defined signal strength threshold (such a threshold sets the sensitivity limit of the system).

## 5.9 WaveMatch

Advanced capture logic locks onto the synchronization word and does not require preamble settling bytes. Therefore, receiver settling time is reduced to the settling time of the AGC, typically 4 bits.

The WaveMatch feature also greatly reduces false sync triggering on noise, further reducing the power consumption and improving sensitivity and reliability. The same logic can also be used as a high-performance preamble detector to reliably detect a valid preamble in the channel.

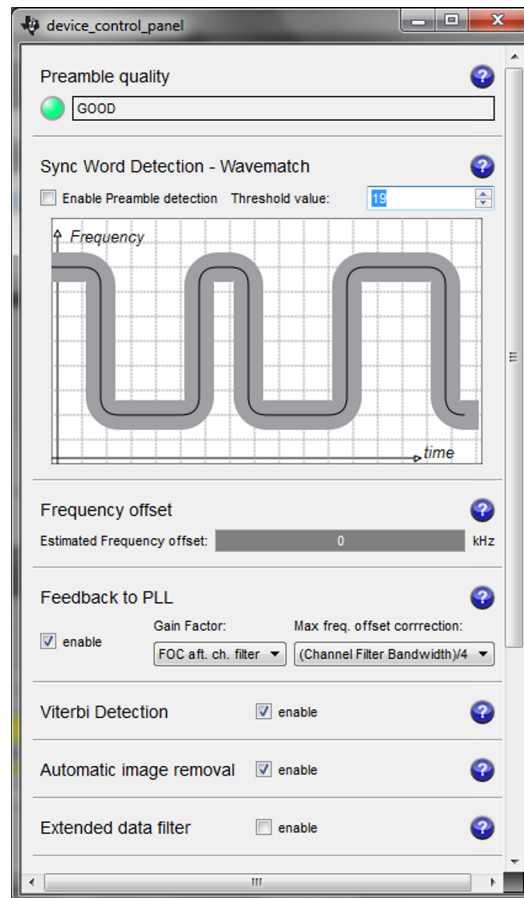

See [SWRC046](#) for more information.

**Figure 5-2. Receiver Configurator in SmartRF™ Studio**

## 6 Typical Application Circuit

### NOTE

This section is intended only as an introduction.

Very few external components are required for the operation of the CC1200 device. [Figure 6-1](#) shows a typical application circuit. The board layout will greatly influence the RF performance of the CC1200 device. Also, [Figure 6-1](#) does not show decoupling capacitors for power pins.

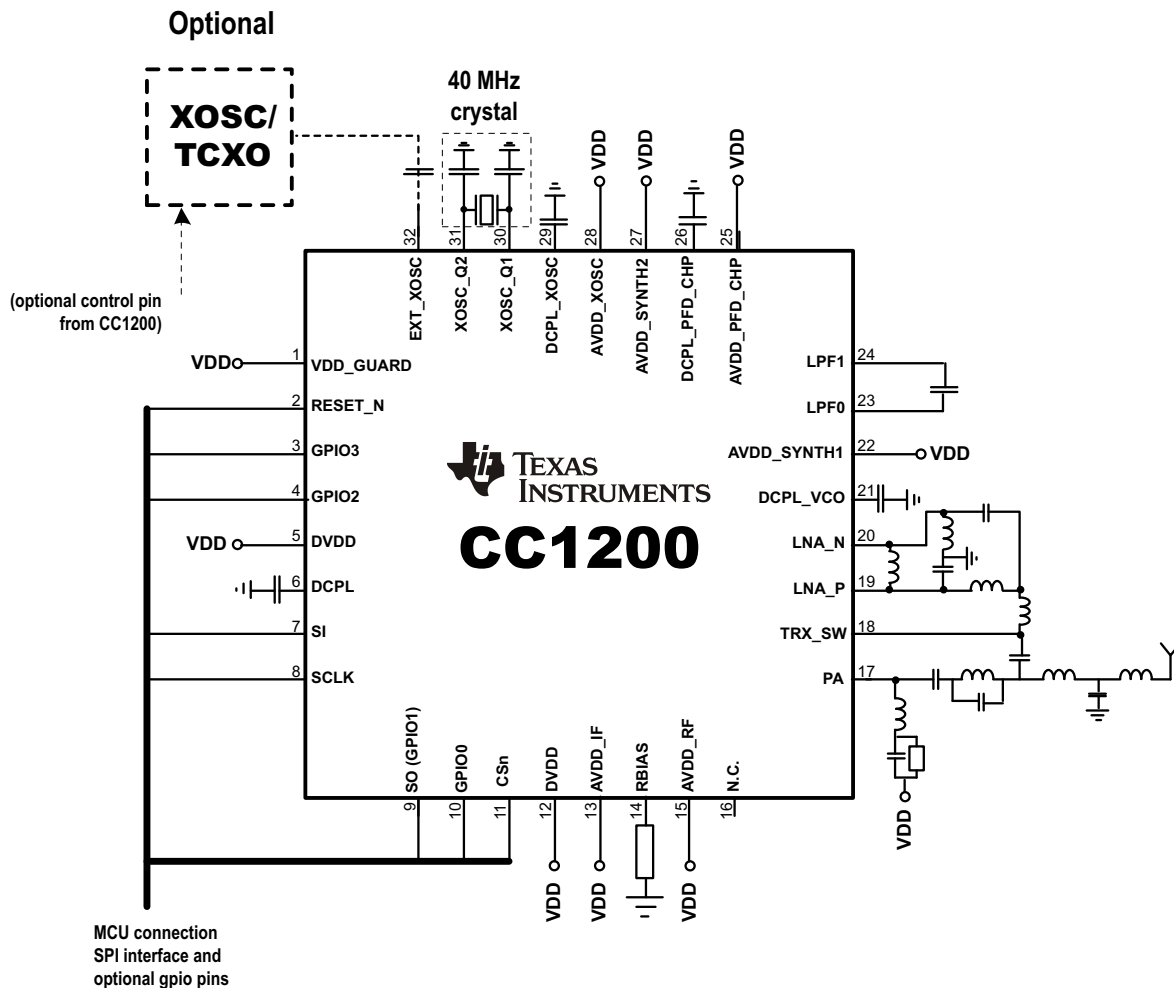

Figure 6-1. Typical Application Circuit

For more information, see the reference designs available for the CC1200 device in [Section 7.2, Documentation Support](#).



## 7 Device and Documentation Support

### 7.1 Device Support

#### 7.1.1 Development Support

##### 7.1.1.1 Configuration Software

The CC1200 device can be configured using the SmartRF Studio software ([SWRC046](#)). The SmartRF Studio software is highly recommended for obtaining optimum register settings, and for evaluating performance and functionality.

#### 7.1.2 Device and Development-Support Tool Nomenclature

To designate the stages in the product development cycle, TI assigns prefixes to the part numbers of all microprocessors (MPUs) and support tools. Each device has one of three prefixes: X, P, or null (no prefix) (for example, CC1200). Texas Instruments recommends two of three possible prefix designators for its support tools: TMDX and TMDS. These prefixes represent evolutionary stages of product development from engineering prototypes (TMDX) through fully qualified production devices and tools (TMDS).

Device development evolutionary flow:

- X** Experimental device that is not necessarily representative of the final device's electrical specifications and may not use production assembly flow.
- P** Prototype device that is not necessarily the final silicon die and may not necessarily meet final electrical specifications.
- null** Production version of the silicon die that is fully qualified.

Support tool development evolutionary flow:

- TMDX** Development-support product that has not yet completed Texas Instruments internal qualification testing.
- TMDS** Fully qualified development-support product.

X and P devices and TMDX development-support tools are shipped against the following disclaimer:

"Developmental product is intended for internal evaluation purposes."

Production devices and TMDS development-support tools have been characterized fully, and the quality and reliability of the device have been demonstrated fully. TI's standard warranty applies.

Predictions show that prototype devices (X or P) have a greater failure rate than the standard production devices. Texas Instruments recommends that these devices not be used in any production system because their expected end-use failure rate still is undefined. Only qualified production devices are to be used.

TI device nomenclature also includes a suffix with the device family name. This suffix indicates the package type (for example, RHB) and the temperature range (for example, blank is the default commercial temperature range) provides a legend for reading the complete device name for any CC1200 device.

For orderable part numbers of CC1200 devices in the QFN package types, see the Package Option Addendum of this document, the TI website ([www.ti.com](http://www.ti.com)), or contact your TI sales representative.

## 7.2 Documentation Support

The following documents supplement the CC1200 processor. Copies of these documents are available on the Internet at [www.ti.com](http://www.ti.com). *Tip:* Enter the literature number in the search box provided at [www.ti.com](http://www.ti.com).

[SWRR106](#) CC112x IPC 868- and 915-MHz 2-layer Reference Design

[SWRR107](#) CC112x IPC 868- and 915-MHz 4-layer Reference Design

[SWRR122](#) CC1200EM 420- to 470-MHz Reference Design

[SWRR121](#) CC1200EM 868- to 930-MHz Reference Design

[SWRC046](#) SmartRF Studio Software

[SWRA428](#) CC112x/CC120x Sniff Mode Application Note

## 7.3 Community Resources

The following links connect to TI community resources. Linked contents are provided "AS IS" by the respective contributors. They do not constitute TI specifications and do not necessarily reflect TI's views; see TI's [Terms of Use](#).

[TI E2E™ Online Community](#) *TI's Engineer-to-Engineer (E2E) Community*. Created to foster collaboration among engineers. At [e2e.ti.com](http://e2e.ti.com), you can ask questions, share knowledge, explore ideas and help solve problems with fellow engineers.

[TI Embedded Processors Wiki](#) *Texas Instruments Embedded Processors Wiki*. Established to help developers get started with Embedded Processors from Texas Instruments and to foster innovation and growth of general knowledge about the hardware and software surrounding these devices.

## 7.4 Trademarks

SmartRF, E2E are trademarks of Texas Instruments.  
All other trademarks are the property of their respective owners.

## 7.5 Electrostatic Discharge Caution



This integrated circuit can be damaged by ESD. Texas Instruments recommends that all integrated circuits be handled with appropriate precautions. Failure to observe proper handling and installation procedures can cause damage.

ESD damage can range from subtle performance degradation to complete device failure. Precision integrated circuits may be more susceptible to damage because very small parametric changes could cause the device not to meet its published specifications.

## 7.6 Glossary

[SLYZ022](#) — *TI Glossary*.

This glossary lists and explains terms, acronyms, and definitions.

## 8 Mechanical Packaging and Orderable Information

The following pages include mechanical packaging and orderable information. This information is the most current data available for the designated devices. This data is subject to change without notice and revision of this document. For browser-based versions of this data sheet, refer to the left-hand navigation.

**PACKAGING INFORMATION**

Orderable Device	Status (1)	Package Type	Package Drawing	Pins	Package Qty	Eco Plan (2)	Lead/Ball Finish (6)	MSL Peak Temp (3)	Op Temp (°C)	Device Marking (4/5)	Samples
CC1200RHBR	ACTIVE	VQFN	RHB	32	3000	Green (RoHS & no Sb/Br)	CU NIPDAU	Level-3-260C-168 HR	-40 to 85	CC1200	<a href="#">Samples</a>
CC1200RHBT	ACTIVE	VQFN	RHB	32	250	Green (RoHS & no Sb/Br)	CU NIPDAU	Level-3-260C-168 HR	-40 to 85	CC1200	<a href="#">Samples</a>

(1) The marketing status values are defined as follows:

**ACTIVE:** Product device recommended for new designs.

**LIFEBUY:** TI has announced that the device will be discontinued, and a lifetime-buy period is in effect.

**NRND:** Not recommended for new designs. Device is in production to support existing customers, but TI does not recommend using this part in a new design.

**PREVIEW:** Device has been announced but is not in production. Samples may or may not be available.

**OBSOLETE:** TI has discontinued the production of the device.

(2) Eco Plan - The planned eco-friendly classification: Pb-Free (RoHS), Pb-Free (RoHS Exempt), or Green (RoHS & no Sb/Br) - please check <http://www.ti.com/productcontent> for the latest availability information and additional product content details.

**TBD:** The Pb-Free/Green conversion plan has not been defined.

**Pb-Free (RoHS):** TI's terms "Lead-Free" or "Pb-Free" mean semiconductor products that are compatible with the current RoHS requirements for all 6 substances, including the requirement that lead not exceed 0.1% by weight in homogeneous materials. Where designed to be soldered at high temperatures, TI Pb-Free products are suitable for use in specified lead-free processes.

**Pb-Free (RoHS Exempt):** This component has a RoHS exemption for either 1) lead-based flip-chip solder bumps used between the die and package, or 2) lead-based die adhesive used between the die and leadframe. The component is otherwise considered Pb-Free (RoHS compatible) as defined above.

**Green (RoHS & no Sb/Br):** TI defines "Green" to mean Pb-Free (RoHS compatible), and free of Bromine (Br) and Antimony (Sb) based flame retardants (Br or Sb do not exceed 0.1% by weight in homogeneous material)

(3) MSL, Peak Temp. - The Moisture Sensitivity Level rating according to the JEDEC industry standard classifications, and peak solder temperature.

(4) There may be additional marking, which relates to the logo, the lot trace code information, or the environmental category on the device.

(5) Multiple Device Markings will be inside parentheses. Only one Device Marking contained in parentheses and separated by a "~" will appear on a device. If a line is indented then it is a continuation of the previous line and the two combined represent the entire Device Marking for that device.

(6) Lead/Ball Finish - Orderable Devices may have multiple material finish options. Finish options are separated by a vertical ruled line. Lead/Ball Finish values may wrap to two lines if the finish value exceeds the maximum column width.

**Important Information and Disclaimer:** The information provided on this page represents TI's knowledge and belief as of the date that it is provided. TI bases its knowledge and belief on information provided by third parties, and makes no representation or warranty as to the accuracy of such information. Efforts are underway to better integrate information from third parties. TI has taken and continues to take reasonable steps to provide representative and accurate information but may not have conducted destructive testing or chemical analysis on incoming materials and chemicals. TI and TI suppliers consider certain information to be proprietary, and thus CAS numbers and other limited information may not be available for release.

In no event shall TI's liability arising out of such information exceed the total purchase price of the TI part(s) at issue in this document sold by TI to Customer on an annual basis.

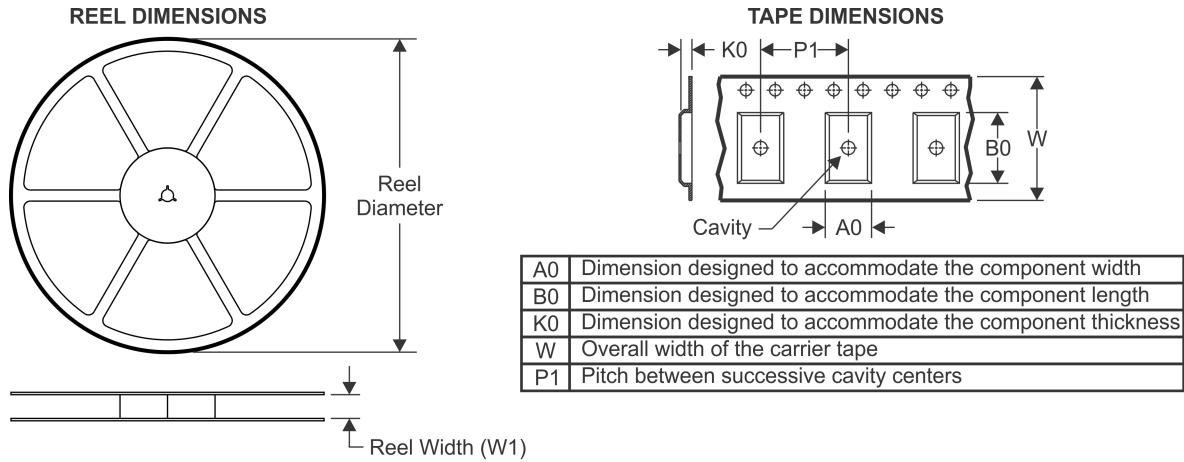
**TAPE AND REEL INFORMATION**

**QUADRANT ASSIGNMENTS FOR PIN 1 ORIENTATION IN TAPE**

\*All dimensions are nominal

Device	Package Type	Package Drawing	Pins	SPQ	Reel Diameter (mm)	Reel Width W1 (mm)	A0 (mm)	B0 (mm)	K0 (mm)	P1 (mm)	W (mm)	Pin1 Quadrant
CC1200RHBR	VQFN	RHB	32	3000	330.0	12.4	5.3	5.3	1.5	8.0	12.0	Q2
CC1200RHBT	VQFN	RHB	32	250	180.0	12.4	5.3	5.3	1.5	8.0	12.0	Q2

**TAPE AND REEL BOX DIMENSIONS**

\*All dimensions are nominal

Device	Package Type	Package Drawing	Pins	SPQ	Length (mm)	Width (mm)	Height (mm)
CC1200RHBR	VQFN	RHB	32	3000	338.1	338.1	20.6
CC1200RHBT	VQFN	RHB	32	250	210.0	185.0	35.0

RHB (S-PVQFN-N32)

PLASTIC QUAD FLATPACK NO-LEAD

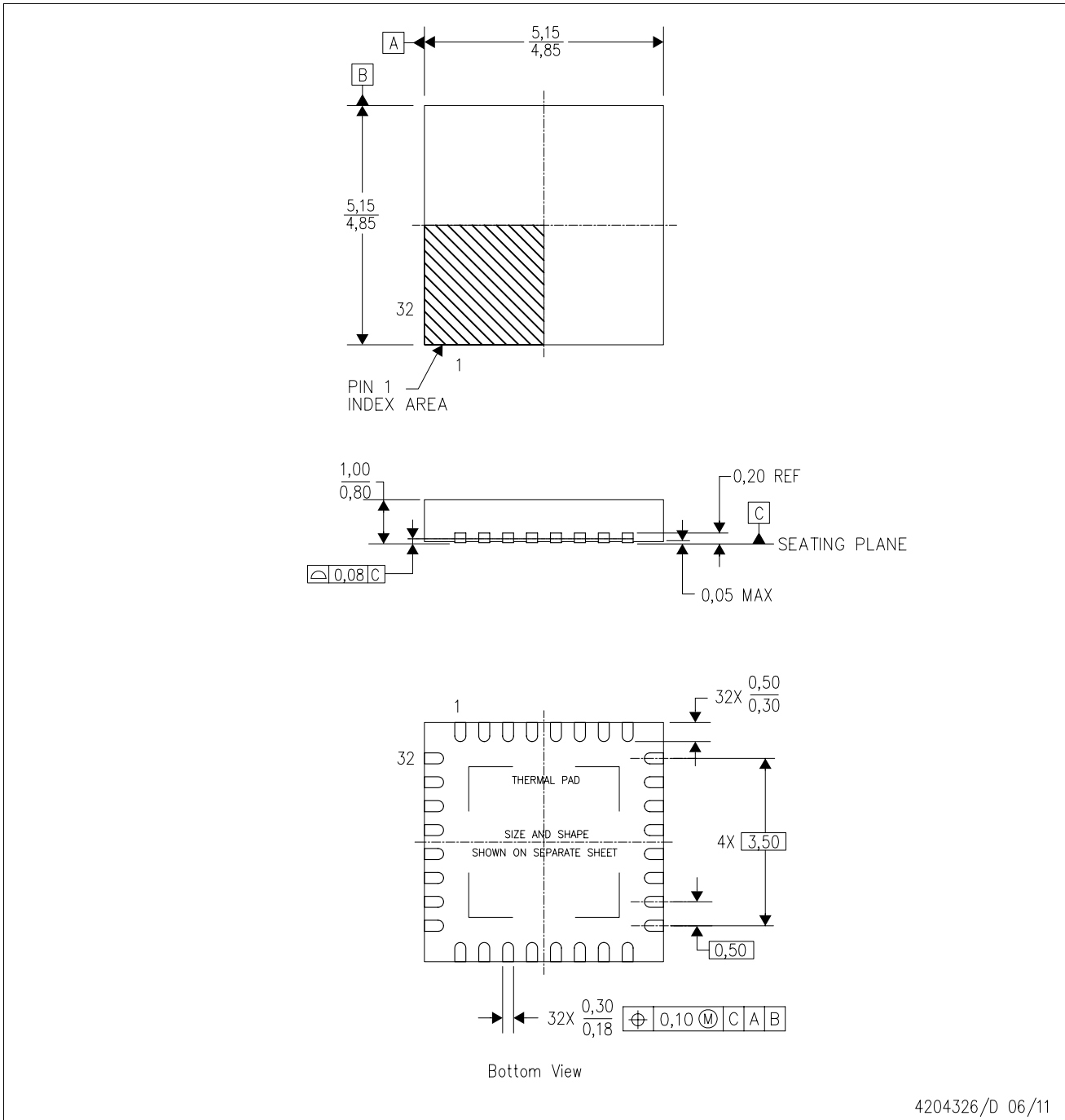

- NOTES:
- All linear dimensions are in millimeters. Dimensioning and tolerancing per ASME Y14.5M-1994.
  - This drawing is subject to change without notice.
  - QFN (Quad Flatpack No-Lead) Package configuration.
  - The package thermal pad must be soldered to the board for thermal and mechanical performance.
  - See the additional figure in the Product Data Sheet for details regarding the exposed thermal pad features and dimensions.
  - Falls within JEDEC MO-220.



THERMAL INFORMATION

This package incorporates an exposed thermal pad that is designed to be attached directly to an external heatsink. The thermal pad must be soldered directly to the printed circuit board (PCB). After soldering, the PCB can be used as a heatsink. In addition, through the use of thermal vias, the thermal pad can be attached directly to the appropriate copper plane shown in the electrical schematic for the device, or alternatively, can be attached to a special heatsink structure designed into the PCB. This design optimizes the heat transfer from the integrated circuit (IC).

For information on the Quad Flatpack No-Lead (QFN) package and its advantages, refer to Application Report, QFN/SON PCB Attachment, Texas Instruments Literature No. SLUA271. This document is available at [www.ti.com](http://www.ti.com).

The exposed thermal pad dimensions for this package are shown in the following illustration.

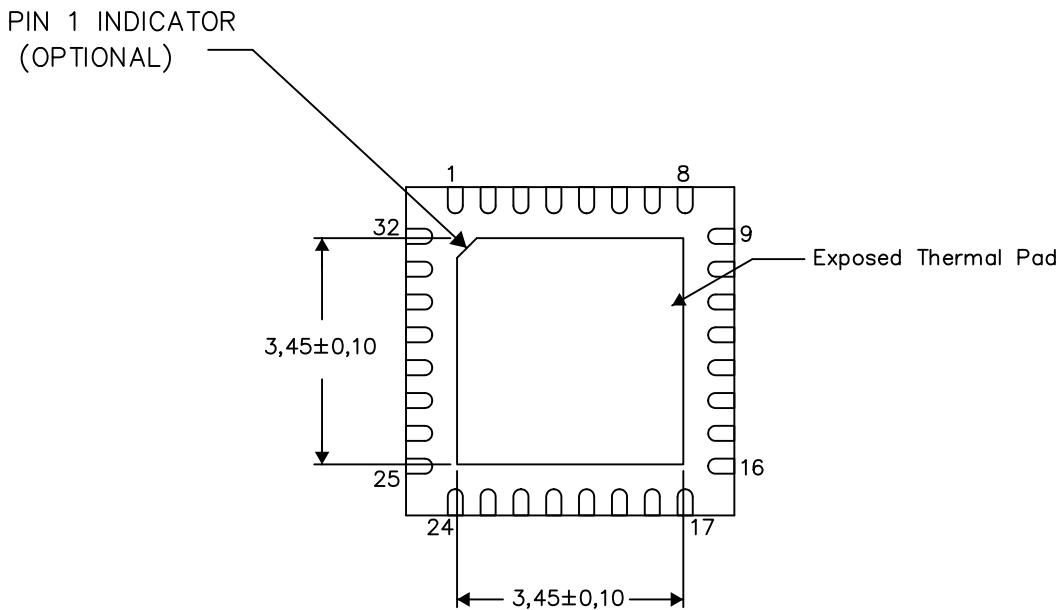

Exposed Thermal Pad Dimensions

4206356-2/AB 07/14

NOTE: A. All linear dimensions are in millimeters

RHB (S-PVQFN-N32)

PLASTIC QUAD FLATPACK NO-LEAD

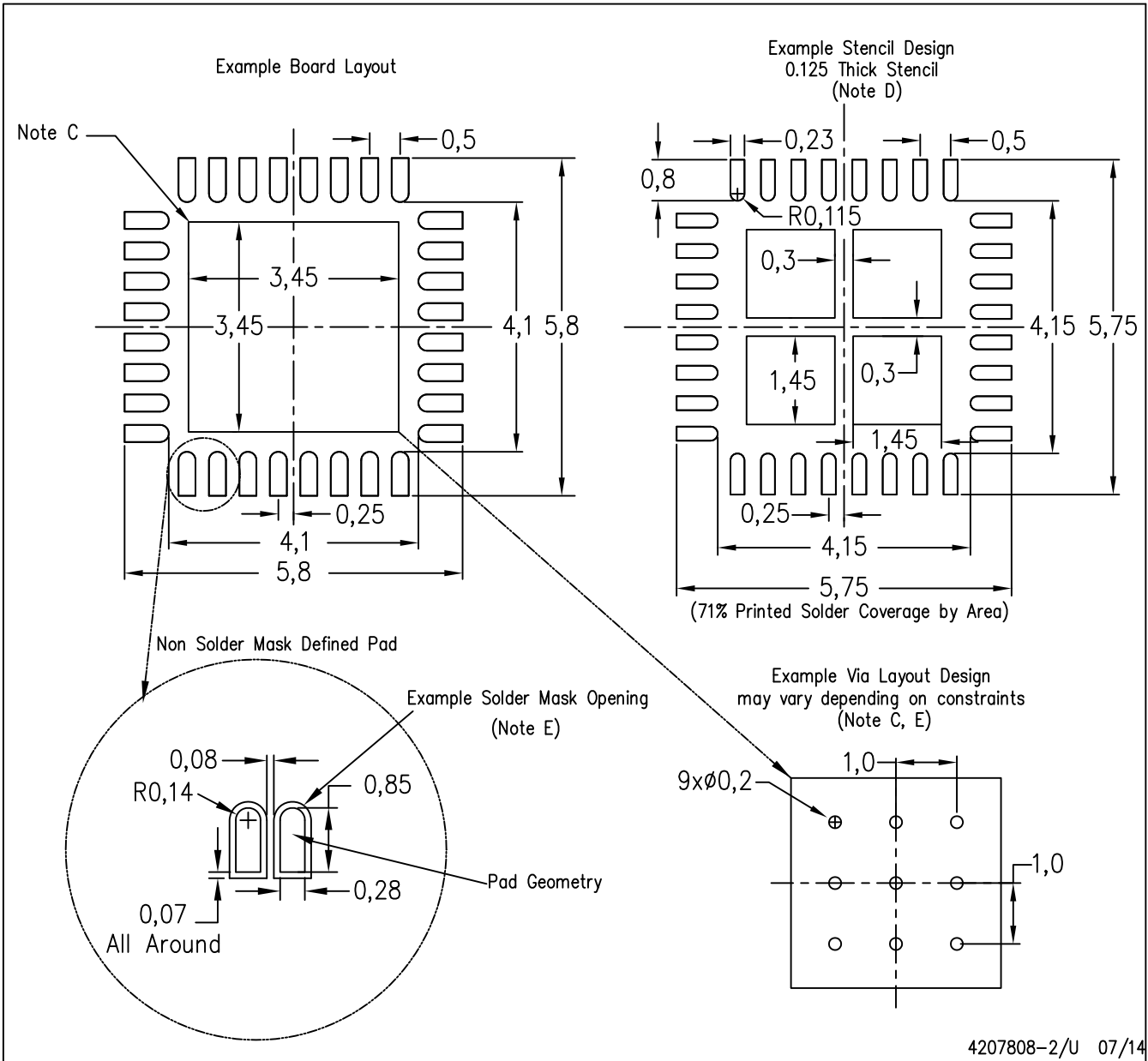

4207808-2/U 07/14

- NOTES:
- A. All linear dimensions are in millimeters.
  - B. This drawing is subject to change without notice.
  - C. This package is designed to be soldered to a thermal pad on the board. Refer to Application Note, Quad Flat-Pack Packages, Texas Instruments Literature No. SLUA271, and also the Product Data Sheets for specific thermal information, via requirements, and recommended board layout. These documents are available at [www.ti.com](http://www.ti.com) <<http://www.ti.com>>.
  - D. Laser cutting apertures with trapezoidal walls and also rounding corners will offer better paste release. Customers should contact their board assembly site for stencil design recommendations. Refer to IPC 7525 for stencil design considerations.
  - E. Customers should contact their board fabrication site for recommended solder mask tolerances and via tenting recommendations for any larger diameter vias placed in the thermal pad.

## IMPORTANT NOTICE

Texas Instruments Incorporated and its subsidiaries (TI) reserve the right to make corrections, enhancements, improvements and other changes to its semiconductor products and services per JESD46, latest issue, and to discontinue any product or service per JESD48, latest issue. Buyers should obtain the latest relevant information before placing orders and should verify that such information is current and complete. All semiconductor products (also referred to herein as "components") are sold subject to TI's terms and conditions of sale supplied at the time of order acknowledgment.

TI warrants performance of its components to the specifications applicable at the time of sale, in accordance with the warranty in TI's terms and conditions of sale of semiconductor products. Testing and other quality control techniques are used to the extent TI deems necessary to support this warranty. Except where mandated by applicable law, testing of all parameters of each component is not necessarily performed.

TI assumes no liability for applications assistance or the design of Buyers' products. Buyers are responsible for their products and applications using TI components. To minimize the risks associated with Buyers' products and applications, Buyers should provide adequate design and operating safeguards.

TI does not warrant or represent that any license, either express or implied, is granted under any patent right, copyright, mask work right, or other intellectual property right relating to any combination, machine, or process in which TI components or services are used. Information published by TI regarding third-party products or services does not constitute a license to use such products or services or a warranty or endorsement thereof. Use of such information may require a license from a third party under the patents or other intellectual property of the third party, or a license from TI under the patents or other intellectual property of TI.

Reproduction of significant portions of TI information in TI data books or data sheets is permissible only if reproduction is without alteration and is accompanied by all associated warranties, conditions, limitations, and notices. TI is not responsible or liable for such altered documentation. Information of third parties may be subject to additional restrictions.

Resale of TI components or services with statements different from or beyond the parameters stated by TI for that component or service voids all express and any implied warranties for the associated TI component or service and is an unfair and deceptive business practice. TI is not responsible or liable for any such statements.

Buyer acknowledges and agrees that it is solely responsible for compliance with all legal, regulatory and safety-related requirements concerning its products, and any use of TI components in its applications, notwithstanding any applications-related information or support that may be provided by TI. Buyer represents and agrees that it has all the necessary expertise to create and implement safeguards which anticipate dangerous consequences of failures, monitor failures and their consequences, lessen the likelihood of failures that might cause harm and take appropriate remedial actions. Buyer will fully indemnify TI and its representatives against any damages arising out of the use of any TI components in safety-critical applications.

In some cases, TI components may be promoted specifically to facilitate safety-related applications. With such components, TI's goal is to help enable customers to design and create their own end-product solutions that meet applicable functional safety standards and requirements. Nonetheless, such components are subject to these terms.

No TI components are authorized for use in FDA Class III (or similar life-critical medical equipment) unless authorized officers of the parties have executed a special agreement specifically governing such use.

Only those TI components which TI has specifically designated as military grade or "enhanced plastic" are designed and intended for use in military/aerospace applications or environments. Buyer acknowledges and agrees that any military or aerospace use of TI components which have **not** been so designated is solely at the Buyer's risk, and that Buyer is solely responsible for compliance with all legal and regulatory requirements in connection with such use.

TI has specifically designated certain components as meeting ISO/TS16949 requirements, mainly for automotive use. In any case of use of non-designated products, TI will not be responsible for any failure to meet ISO/TS16949.

### Products

Audio	<a href="http://www.ti.com/audio">www.ti.com/audio</a>
Amplifiers	<a href="http://amplifier.ti.com">amplifier.ti.com</a>
Data Converters	<a href="http://dataconverter.ti.com">dataconverter.ti.com</a>
DLP® Products	<a href="http://www.dlp.com">www.dlp.com</a>
DSP	<a href="http://dsp.ti.com">dsp.ti.com</a>
Clocks and Timers	<a href="http://www.ti.com/clocks">www.ti.com/clocks</a>
Interface	<a href="http://interface.ti.com">interface.ti.com</a>
Logic	<a href="http://logic.ti.com">logic.ti.com</a>
Power Mgmt	<a href="http://power.ti.com">power.ti.com</a>
Microcontrollers	<a href="http://microcontroller.ti.com">microcontroller.ti.com</a>
RFID	<a href="http://www.ti-rfid.com">www.ti-rfid.com</a>
OMAP Applications Processors	<a href="http://www.ti.com/omap">www.ti.com/omap</a>
Wireless Connectivity	<a href="http://www.ti.com/wirelessconnectivity">www.ti.com/wirelessconnectivity</a>

### Applications

Automotive and Transportation	<a href="http://www.ti.com/automotive">www.ti.com/automotive</a>
Communications and Telecom	<a href="http://www.ti.com/communications">www.ti.com/communications</a>
Computers and Peripherals	<a href="http://www.ti.com/computers">www.ti.com/computers</a>
Consumer Electronics	<a href="http://www.ti.com/consumer-apps">www.ti.com/consumer-apps</a>
Energy and Lighting	<a href="http://www.ti.com/energy">www.ti.com/energy</a>
Industrial	<a href="http://www.ti.com/industrial">www.ti.com/industrial</a>
Medical	<a href="http://www.ti.com/medical">www.ti.com/medical</a>
Security	<a href="http://www.ti.com/security">www.ti.com/security</a>
Space, Avionics and Defense	<a href="http://www.ti.com/space-avionics-defense">www.ti.com/space-avionics-defense</a>
Video and Imaging	<a href="http://www.ti.com/video">www.ti.com/video</a>

### TI E2E Community

[e2e.ti.com](http://e2e.ti.com)



## Стандарт Электрон Связь

Мы молодая и активно развивающаяся компания в области поставок электронных компонентов. Мы поставляем электронные компоненты отечественного и импортного производства напрямую от производителей и с крупнейших складов мира.

Благодаря сотрудничеству с мировыми поставщиками мы осуществляем комплексные и плановые поставки широчайшего спектра электронных компонентов.

Собственная эффективная логистика и склад в обеспечивает надежную поставку продукции в точно указанные сроки по всей России.

Мы осуществляем техническую поддержку нашим клиентам и предпродажную проверку качества продукции. На все поставляемые продукты мы предоставляем гарантию .

Осуществляем поставки продукции под контролем ВП МО РФ на предприятия военно-промышленного комплекса России , а также работаем в рамках 275 ФЗ с открытием отдельных счетов в уполномоченном банке. Система менеджмента качества компании соответствует требованиям ГОСТ ISO 9001.

Минимальные сроки поставки, гибкие цены, неограниченный ассортимент и индивидуальный подход к клиентам являются основой для выстраивания долгосрочного и эффективного сотрудничества с предприятиями радиоэлектронной промышленности, предприятиями ВПК и научно-исследовательскими институтами России.

С нами вы становитесь еще успешнее!

### Наши контакты:

**Телефон:** +7 812 627 14 35

**Электронная почта:** [sales@st-electron.ru](mailto:sales@st-electron.ru)

**Адрес:** 198099, Санкт-Петербург,  
Промышленная ул, дом № 19, литера Н,  
помещение 100-Н Офис 331