

FEATURES

High output power for 1 dB compression (P_{1dB}): 22 dBm
High saturated output power (P_{SAT}): 24 dBm
High gain: 13 dB
High output third-order intercept (IP₃): 33.5 dBm
Supply voltage: 10 V at 175 mA
50 Ω matched input/output
Die size: 2.82 mm × 1.50 mm × 0.1 mm

APPLICATIONS

Test instrumentation
Microwave radios and VSATs
Military and space
Telecommunications infrastructure
Fiber optics

GENERAL DESCRIPTION

The [HMC930A](#) is a gallium arsenide (GaAs), pseudomorphic, high electron mobility transfer (pHEMT), monolithic microwave integrated circuit (MMIC), distributed power amplifier that operates from dc to 40 GHz. The [HMC930A](#) provides 13 dB of gain, 33.5 dBm output IP₃, and 22 dBm of output power at 1 dB gain compression, requiring 175 mA from a 10 V supply. The [HMC930A](#) exhibits a slightly positive gain slope from 8 GHz to

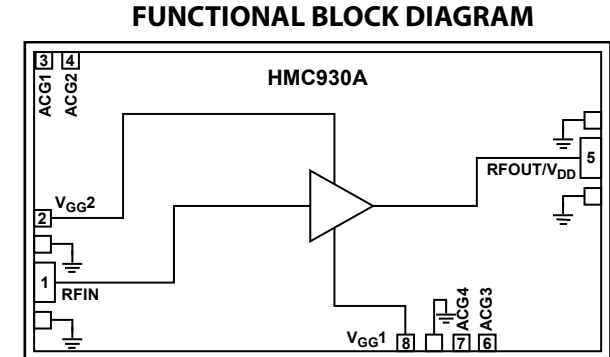

Figure 1.

32 GHz, making it ideal for electronic warfare (EW), electronic countermeasures (ECM), radar, and test equipment applications. The [HMC930A](#) amplifier inputs/outputs (I/Os) are internally matched to 50 Ω, facilitating integration into multichip modules (MCMs). All data is taken with the chip connected via two 0.025 mm (1 mil) wire bonds of minimal length at 0.31 mm (12 mils).

TABLE OF CONTENTS

Features	1	Pin Configuration and Function Descriptions.....	6
Applications.....	1	Interface Schematics	7
Functional Block Diagram	1	Typical Performance Characteristics	8
General Description	1	Theory of Operation	13
Revision History	2	Applications Information	14
Electrical Specifications	3	Biasing Procedures.....	14
DC to 12 GHz Frequency Range.....	3	Mounting and Bonding Techniques for Millimeterwave GaAs MMICs.....	15
12 GHz to 32 GHz Frequency Range.....	3	Outline Dimensions	16
32 GHz to 40 GHz Frequency Range.....	4	Die Packaging Information.....	16
Total Supply Current by V_{DD}	4	Ordering Guide.....	16
Absolute Maximum Ratings.....	5		
ESD Caution.....	5		

REVISION HISTORY

12/15—Revision 0: Initial Version

ELECTRICAL SPECIFICATIONS

DC TO 12 GHz FREQUENCY RANGE

$T_A = 25^\circ\text{C}$, $V_{DD} = 10\text{ V}$, $V_{GG2} = 3.5\text{ V}$, $I_{DD} = 175\text{ mA}$. Adjust V_{GG1} between -2 V to 0 V to achieve $I_{DD} = 175\text{ mA}$, typical.

Table 1.

Parameter	Symbol	Test Conditions/Comments	Min	Typ	Max	Unit
FREQUENCY RANGE			DC		12	GHz
GAIN			11.5	13.5		dB
Gain Flatness				± 0.5		dB
Gain Variation Over Temperature				0.01		dB/ $^\circ\text{C}$
RETURN LOSS						
Input				18		dB
Output				28		dB
OUTPUT						
Output Power for 1 dB Compression	P1dB		21	23		dBm
Saturated Output Power	P_{SAT}			25		dBm
Output Third-Order Intercept	IP3			36		dBm
NOISE FIGURE				4.5		dB
SUPPLY CURRENT	I_{DD}	$V_{DD} = 10\text{ V}$, $V_{GG1} = -0.8\text{ V}$, typical		175		mA

12 GHz TO 32 GHz FREQUENCY RANGE

$T_A = 25^\circ\text{C}$, $V_{DD} = 10\text{ V}$, $V_{GG2} = 3.5\text{ V}$, $I_{DD} = 175\text{ mA}$. Adjust V_{GG1} between -2 V to 0 V to achieve $I_{DD} = 175\text{ mA}$, typical.

Table 2.

Parameter	Symbol	Test Conditions/Comments	Min	Typ	Max	Unit
FREQUENCY RANGE			12		32	GHz
GAIN			11	13		dB
Gain Flatness				± 0.3		dB
Gain Variation Over Temperature				0.017		dB/ $^\circ\text{C}$
RETURN LOSS						
Input				16		dB
Output				20		dB
OUTPUT						
Output Power for 1 dB Compression	P1dB			22		dBm
Saturated Output Power	P_{SAT}			24		dBm
Output Third-Order Intercept	IP3			33.5		dBm
NOISE FIGURE				5		dB
SUPPLY CURRENT	I_{DD}	$V_{DD} = 10\text{ V}$, $V_{GG1} = -0.8\text{ V}$, typical		175		mA

32 GHz TO 40 GHz FREQUENCY RANGE

$T_A = 25^\circ\text{C}$, $V_{DD} = 10\text{ V}$, $V_{GG2} = 3.5\text{ V}$, $I_{DD} = 175\text{ mA}$. Adjust V_{GG1} between -2 V to 0 V to achieve $I_{DD} = 175\text{ mA}$, typical.

Table 3.

Parameter	Symbol	Test Conditions/Comments	Min	Typ	Max	Unit
FREQUENCY RANGE			32		40	GHz
GAIN			10	12		dB
Gain Flatness				± 1.0		dB
Gain Variation Over Temperature				0.032		dB/ $^\circ\text{C}$
RETURN LOSS						
Input				15		dB
Output				20		dB
OUTPUT						
Output Power for 1 dB Compression	P1dB			20		dBm
Saturated Output Power	P_{SAT}			23		dBm
Output Third-Order Intercept	IP3			29		dBm
NOISE FIGURE				7.5		dB
SUPPLY CURRENT	I_{DD}	$V_{DD} = 10\text{ V}, V_{GG1} = -0.8\text{ V}$, typical		175		mA

TOTAL SUPPLY CURRENT BY V_{DD}

Table 4.

Parameter	Symbol	Min	Typ	Max	Unit
SUPPLY CURRENT	I_{DD}				
$V_{DD} = 9\text{ V}$			175		mA
$V_{DD} = 10\text{ V}$			175		mA
$V_{DD} = 11\text{ V}$			175		mA

ABSOLUTE MAXIMUM RATINGS

Table 5.

Parameter	Rating
Drain Bias Voltage (V_{DD})	13 V
Gate Bias Voltage	
V_{GG1}	-3 V to 0 V dc
V_{GG2}	
$V_{DD} = 12 V$	$V_{GG2} = 5.5 V, I_{DD} > 145 mA$
$V_{DD} = 8.5 V \text{ to } 11 V$	$V_{GG2} = (V_{DD} - 6.5 V)$ up to 4.5 V
$V_{DD} < 8.5 V$	V_{GG2} must remain $> 2 V$
RF Input Power (RFIN)	22 dBm
Channel Temperature	150°C
Continuous Power Dissipation, P_{DISS} ($T_A = 85^\circ C$, Derate 69 mW/°C Above 85°C)	2.1 W
Thermal Resistance (Channel to Die Bottom)	31.1°C/W
Output Power into Voltage Standing Wave Ratio (VSWR) $> 7:1$	24 dBm
Storage Temperature Range	-65°C to +150°C
Operating Temperature Range	-55°C to +85°C
ESD Sensitivity, Human Body Model (HBM)	Class 1A, passed 250 V

Stresses at or above those listed under Absolute Maximum Ratings may cause permanent damage to the product. This is a stress rating only; functional operation of the product at these or any other conditions above those indicated in the operational section of this specification is not implied. Operation beyond the maximum operating conditions for extended periods may affect product reliability.

ESD CAUTION



ESD (electrostatic discharge) sensitive device. Charged devices and circuit boards can discharge without detection. Although this product features patented or proprietary protection circuitry, damage may occur on devices subjected to high energy ESD. Therefore, proper ESD precautions should be taken to avoid performance degradation or loss of functionality.

PIN CONFIGURATION AND FUNCTION DESCRIPTIONS

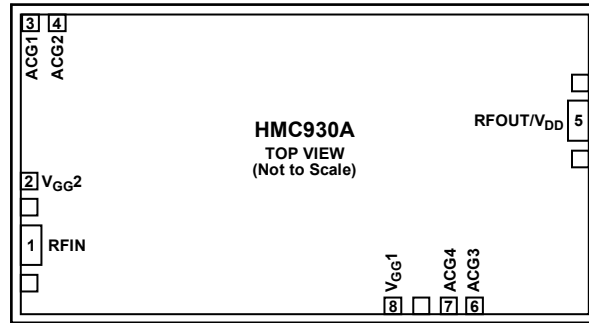

NOTES
1. DIE BOTTOM MUST BE CONNECTED TO RF/DC GROUND.

Figure 2. Pad Configuration

137298-002

Table 6. Pad Function Descriptions

Pad No.	Mnemonic	Description
1	RFIN	RF Input. This pin is dc-coupled and matched to 50 Ω. A blocking capacitor is required on this pin.
2	V _{GG2}	Gate Control 2 for the Amplifier. Attach bypass capacitors as shown in Figure 37. For nominal operation, apply 3.5 V to V _{GG2} .
3	ACG1	Low Frequency Termination 1. Attach bypass capacitors as shown in Figure 37.
4	ACG2	Low Frequency Termination 2. Attach bypass capacitors as shown in Figure 37.
5	RFOUT/V _{DD} ¹	RF Output for the Amplifier (RFOUT). DC Bias (V _{DD}). Connect V _{DD} to the bias tee network to provide the drain current (I _{DD}). See Figure 37.
6	ACG3	Low Frequency Termination 3. Attach bypass capacitors as shown in Figure 37.
7	ACG4	Low Frequency Termination 4. Attach bypass capacitors as shown in Figure 37.
8	V _{GG1}	Gate Control 1 for the Amplifier. Attach bypass capacitors as shown in Figure 37. Follow the procedures described in the Biasing Procedures section.
Die Bottom	GND	Die bottom must be connected to RF/dc ground.

¹ RFOUT/V_{DD} is a multifunction pad.

INTERFACE SCHEMATICS

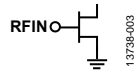

Figure 3. RFIN Interface Schematic

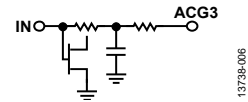

Figure 6. ACG3 Interface Schematic

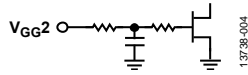

Figure 4. VGG2 Interface Schematic

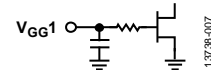

Figure 7. VGG1 Interface Schematic

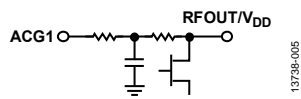

Figure 5. ACG1 and RFOUT/V_{DD} Interface Schematic



Figure 8. GND Interface Schematic

TYPICAL PERFORMANCE CHARACTERISTICS

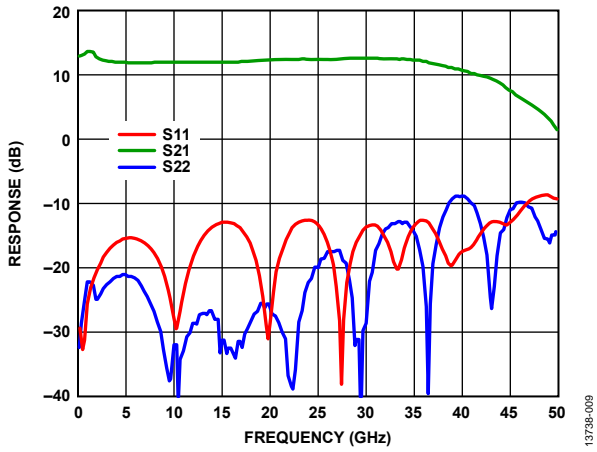

Figure 9. Gain and Return Loss

13738-009

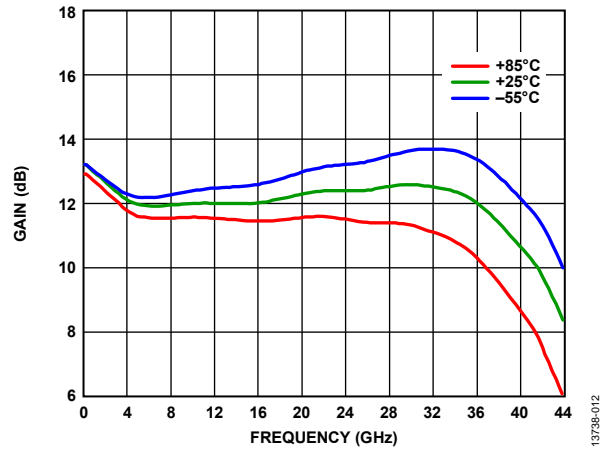

Figure 12. Gain vs. Frequency for Various Temperatures

13738-012

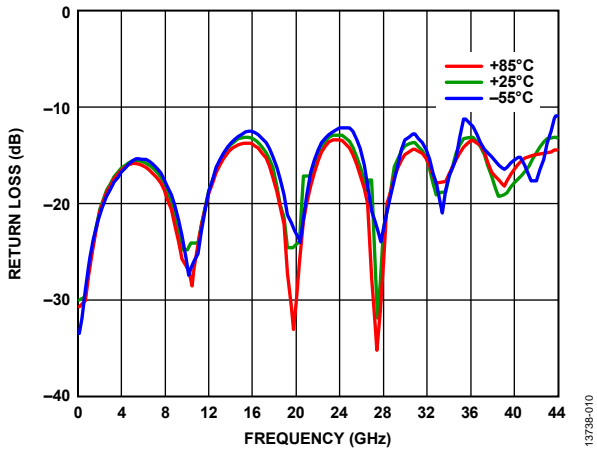

Figure 10. Input Return Loss vs. Frequency for Various Temperatures

13738-010

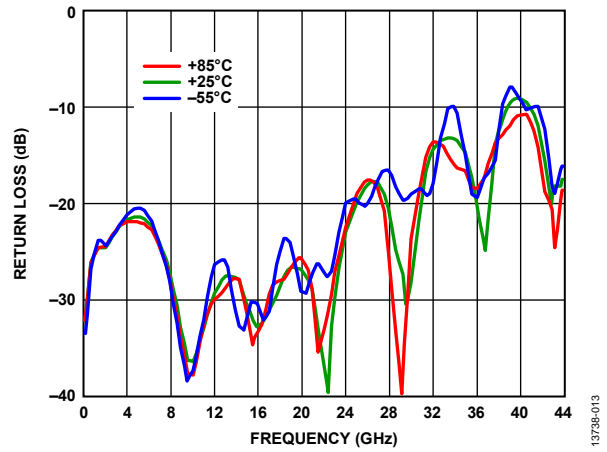

Figure 13. Output Return Loss vs. Frequency for Various Temperatures

13738-013

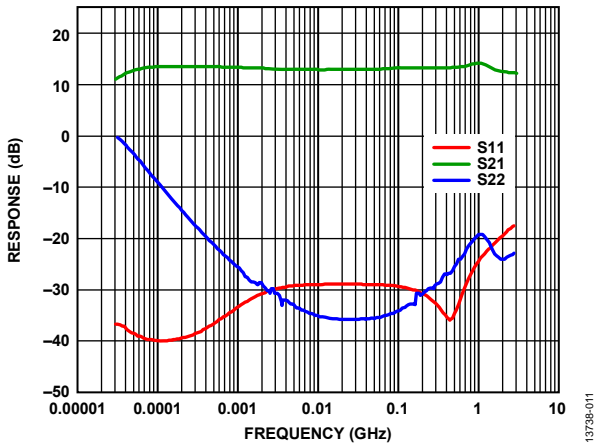

Figure 11. Low Frequency Gain and Return Loss

13738-011

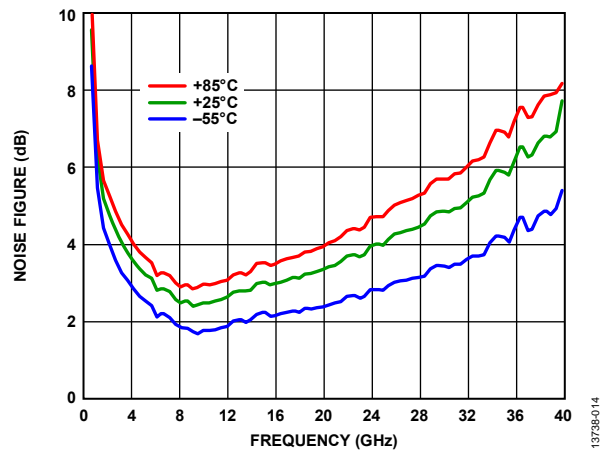

Figure 14. Noise Figure vs. Frequency for Various Temperatures

13738-014

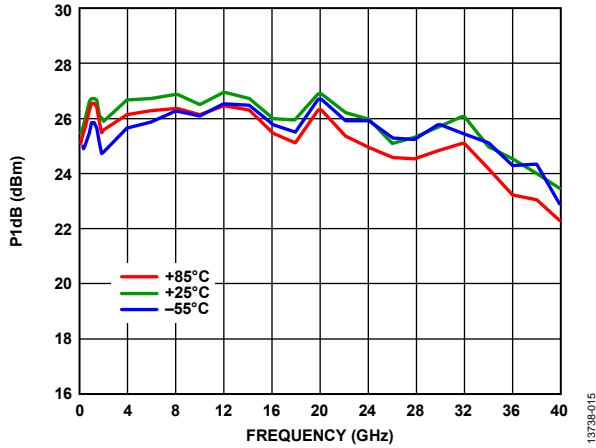

Figure 15. P1dB vs. Frequency for Various Temperatures

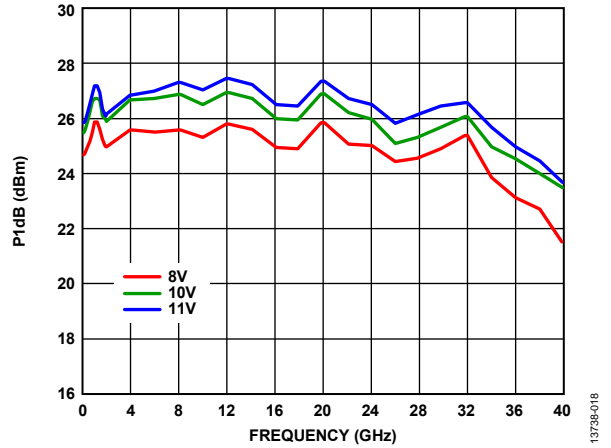

Figure 18. P1dB vs. Frequency for Various Supply Voltages

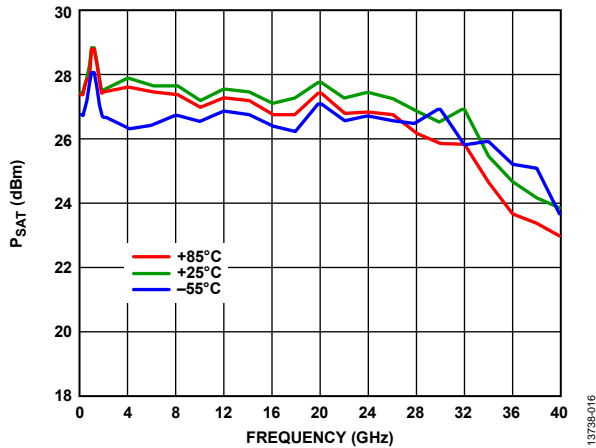

Figure 16. PSAT vs. Frequency for Various Temperatures

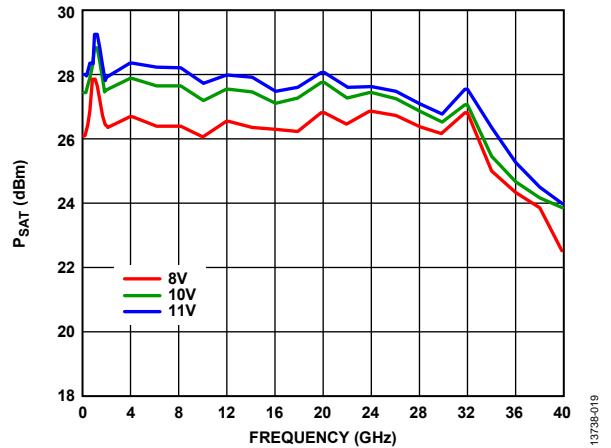

Figure 19. PSAT vs. Frequency for Various Supply Voltages

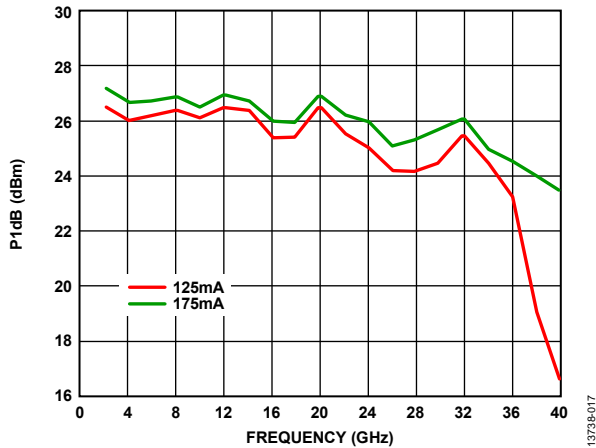

Figure 17. P1dB vs. Frequency and Supply Current

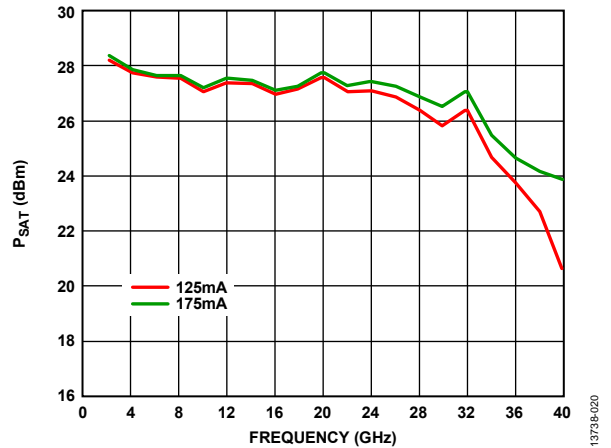

Figure 20. PSAT vs. Frequency and Supply Current

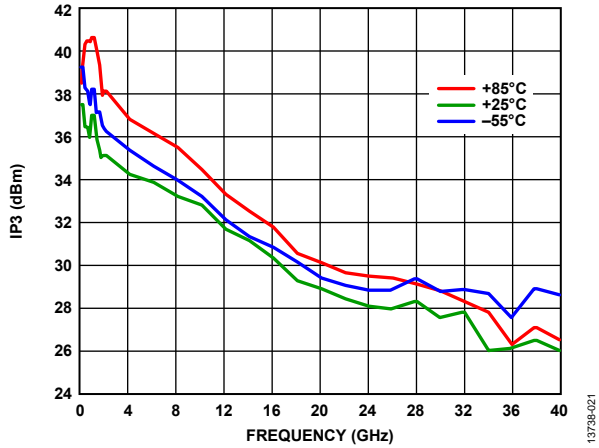

Figure 21. Output IP3 vs. Frequency for Various Temperatures at $P_{OUT} = 14$ dBm/Tone

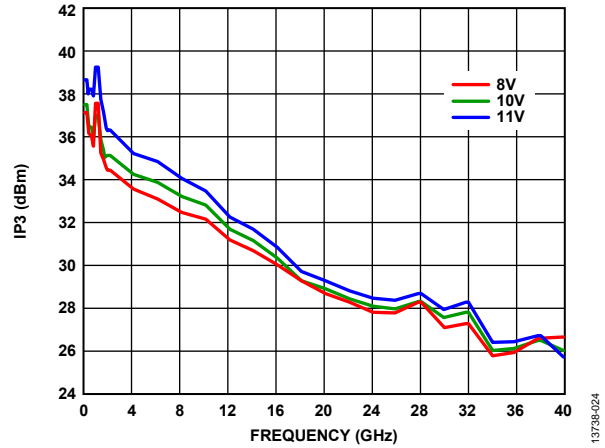

Figure 24. Output IP3 vs. Frequency for Various Supply Voltages at $P_{OUT} = 14$ dBm/Tone

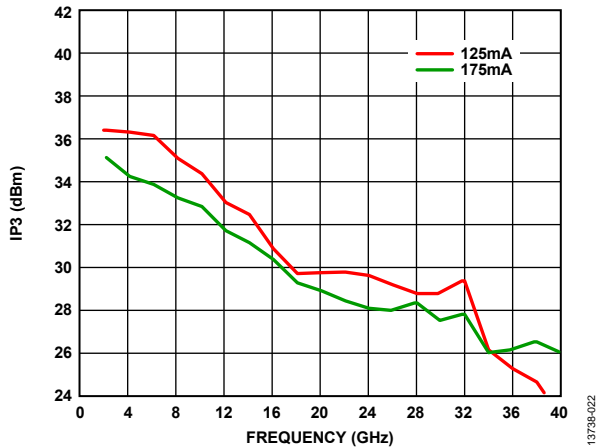

Figure 22. Output IP3 vs. Frequency and Supply Current at $P_{OUT} = 14$ dBm/Tone

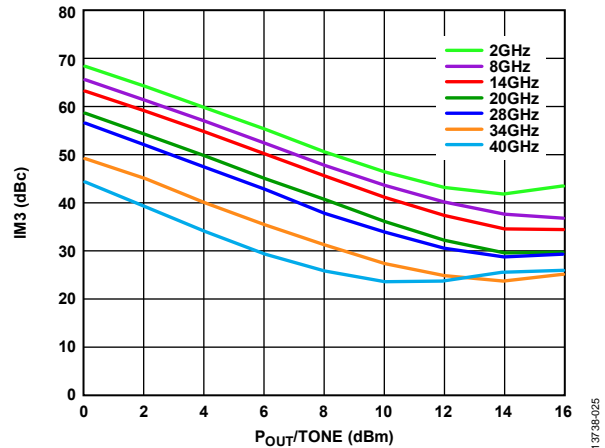

Figure 25. Output IM3 at $V_{DD} = 8$ V

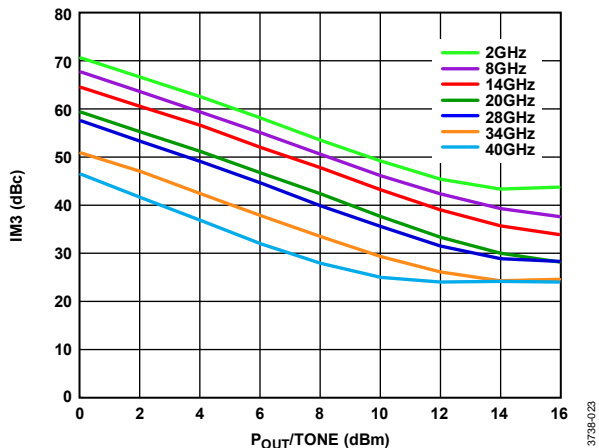

Figure 23. Output Third-Order Intermodulation Tone (IM3) at $V_{DD} = 10$ V

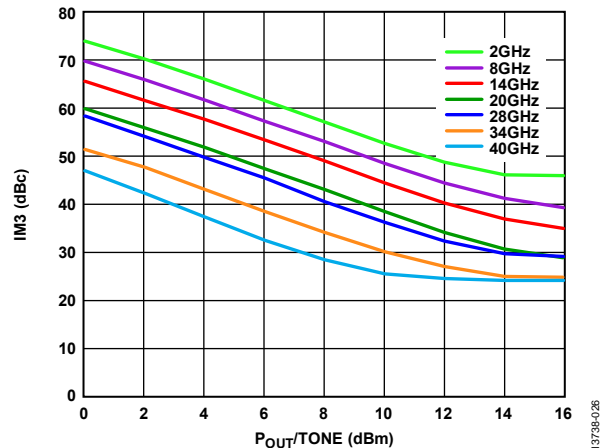

Figure 26. Output IM3 at $V_{DD} = 11$ V

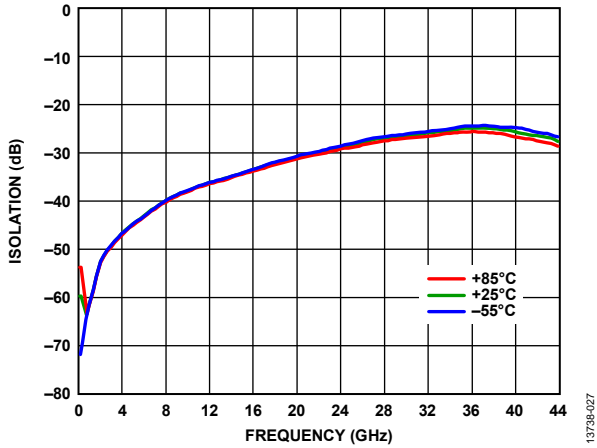

Figure 27. Reverse Isolation vs. Frequency for Various Temperatures

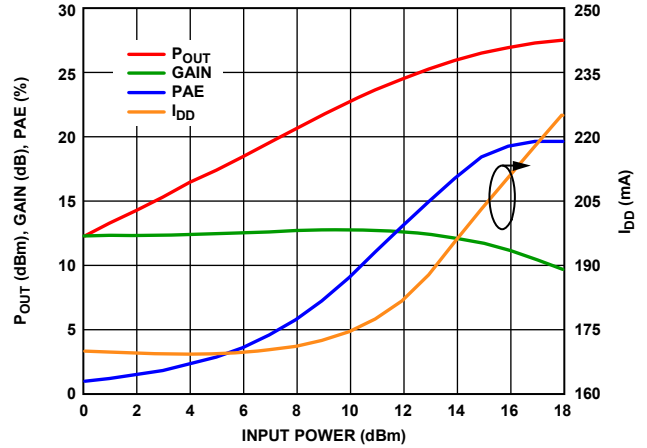

Figure 30. Power Compression at 20 GHz

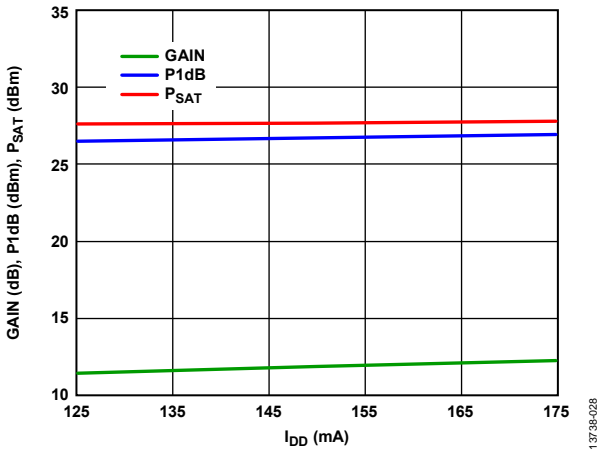

Figure 28. Gain and Power (P1dB and P_{SAT}) vs. Supply Current (I_{DD}) at 20 GHz

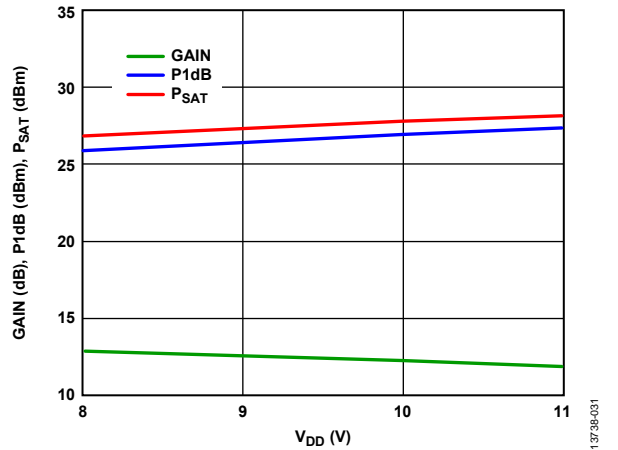

Figure 31. Gain and Power (P1dB and P_{SAT}) vs. Supply Voltage (V_{DD}) at 20 GHz

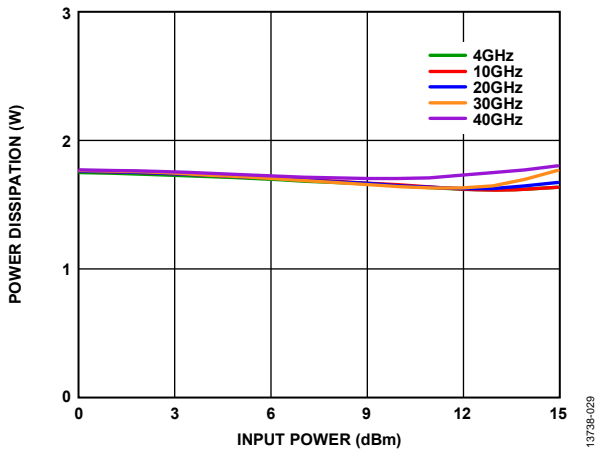

Figure 29. Power Dissipation

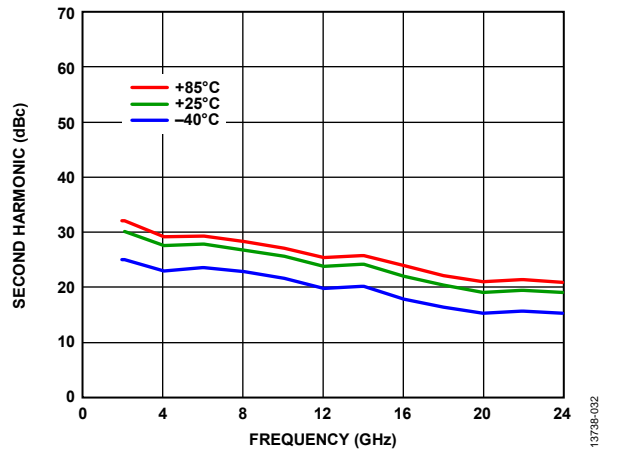

Figure 32. Second-Order Harmonic vs. Frequency for Various Temperatures at $P_{OUT} = 14$ dBm, $V_{DD} = 10$ V, $V_{GG} = 3.5$ V, and $I_{DD} = 175$ mA

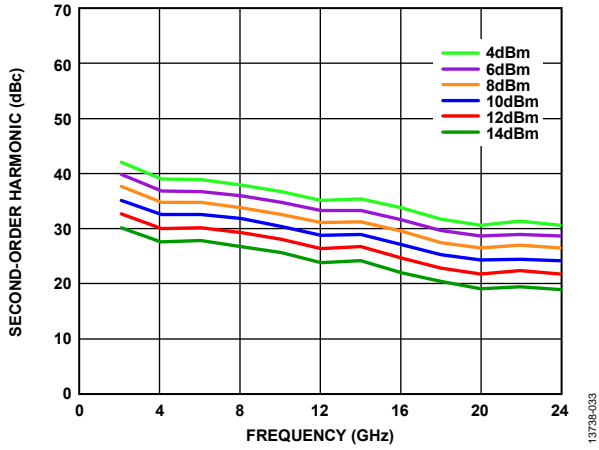

Figure 33. Second-Order Harmonic vs. Frequency for Various P_{OUT} Values, $V_{DD} = 10V$, $V_{GG} = 3.5V$, and $I_{DD} = 175mA$

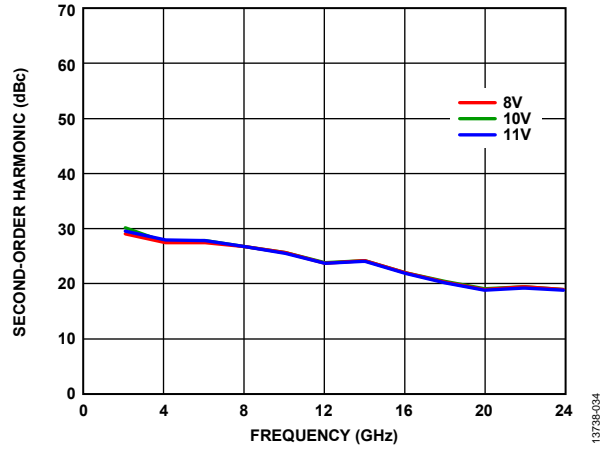

Figure 34. Second-Order Harmonic vs. Frequency for Various V_{DD} Values at $P_{OUT} = 14dBm$ and $I_{DD} = 175mA$

THEORY OF OPERATION

The [HMC930A](#) is a GaAs, pHEMT, MMIC, cascaded, distributed power amplifier. The cascade distributed architecture uses a fundamental cell consisting of a stack of two field effect transistors (FETs) connected from source to drain. The basic schematic for a fundamental cell is shown in Figure 35. The fundamental cell is duplicated several times, with transmission lines connecting the drains of the top devices and the gates of the bottom devices, respectively. Additional circuit design techniques around each cell optimize the overall response. The major benefit of this architecture is that acceptable gain is maintained across a bandwidth that is far greater than what is typically provided by a single instance of the fundamental cell.

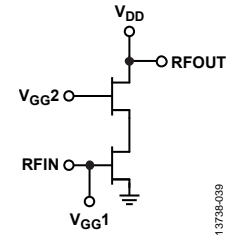

Figure 35. Fundamental Cell Schematic

To obtain the best performance from the [HMC930A](#) and to avoid damaging the device, follow the recommended biasing sequences described in the Biasing Procedures section.

APPLICATIONS INFORMATION

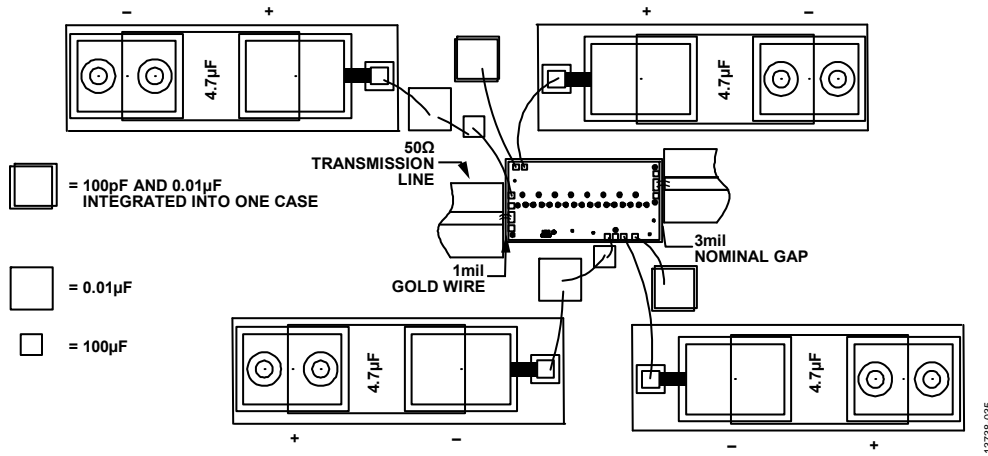

Figure 36. Assembly Diagram

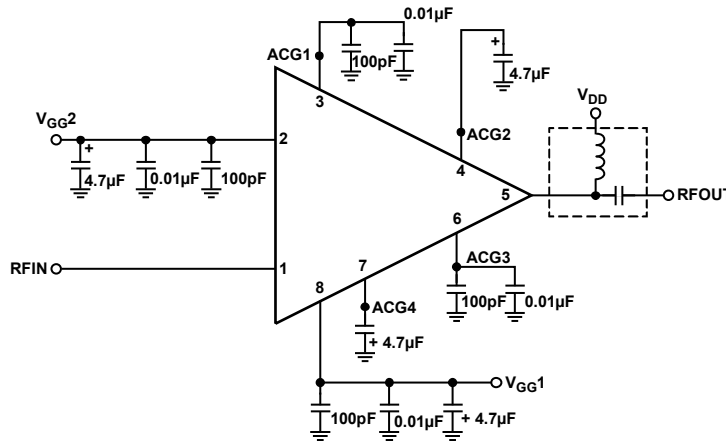

Figure 37. Application Circuit

BIASING PROCEDURES

Capacitive bypassing is required for both V_{GG1} and V_{GG2}, as shown in Figure 37. The capacitors to ground required for the ACG1 through ACG4 pads act as low frequency terminations; this helps flatten the overall frequency response by diminishing the gain at low frequencies.

The recommended biasing sequence during power-up is as follows:

1. Connect to GND.
2. Set V_{GG1} to -2 V to pinch off the drain current.
3. Set V_{DD} to 10 V (the drain current is pinched off).
4. Set V_{GG2} to 3.5 V (the drain current is pinched off).
5. Adjust V_{GG1} in a positive direction until a quiescent current (I_{DD}) of 175 mA is obtained.
6. Apply the RF signal.

The recommended biasing sequence during power-down is as follows:

1. Turn off the RF signal.
2. Set V_{GG1} to -2 V to pinch off the drain current.
3. Set V_{GG2} to 0 V.
4. Set V_{DD} to 0 V.
5. Set V_{GG1} to 0 V.

All measurements for the HMC930A are taken using the typical application circuit (see Figure 37) configured as shown Figure 36. The bias conditions shown in the Electrical Specifications section are the operating points recommended to optimize the overall performance. Unless otherwise noted, the data shown is taken using the recommended bias conditions. Operation of the HMC930A at different bias conditions may provide performance that differs from what is shown in the Typical Performance Characteristics section.

MOUNTING AND BONDING TECHNIQUES FOR MILLIMETERWAVE GaAs MMICS

Attach the die directly to the ground plane eutectically or with conductive epoxy (see the Handling Precautions section, the Mounting section, and the Wire Bonding section).

Microstrip, 50 Ω , transmission lines on 0.127 mm (5 mil) thick alumina, thin film substrates are recommended for bringing the radio frequency to and from the chip (see Figure 38). When using 0.254 mm (10 mil) thick alumina thin film substrates, raise the die 0.150 mm (6 mils) to ensure that the surface of the die is coplanar with the surface of the substrate. One way to accomplish this is to attach the 0.102 mm (4 mil) thick die to a 0.150 mm (6 mil) thick, molybdenum (Mo) heat spreader (moly tab), which is then attached to the ground plane (see Figure 38).

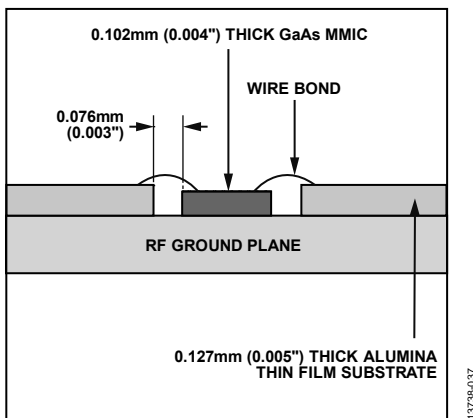

Figure 38. Die Without the Moly Tab

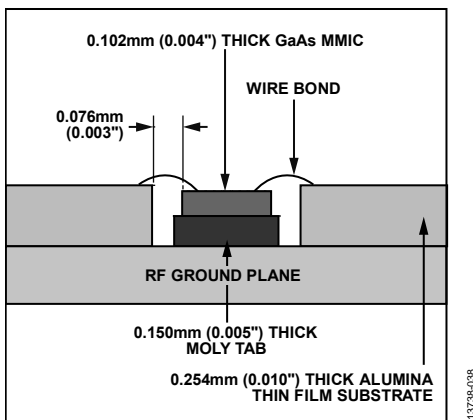

Figure 39. Die With the Moly Tab

Place microstrip substrates as close to the die as possible to minimize bond wire length. Typical die to substrate spacing is 0.076 mm to 0.152 mm (3 mil to 6 mil).

Handling Precautions

To avoid permanent damage, follow these storage, cleanliness, static sensitivity, transient, and general handling precautions:

- Place all bare die in either waffle or gel-based ESD protective containers and then seal the die in an ESD protective bag for shipment. Once the sealed ESD protective bag is opened, store all die in a dry nitrogen environment.
- Handle the chips in a clean environment. Do not attempt to clean the chip using liquid cleaning systems.
- Follow ESD precautions to protect against ESD strikes.
- While bias is applied, suppress instrument and bias supply transients. Use shielded signal and bias cables to minimize inductive pick up.
- Handle the chip along the edges with a vacuum collet or with a sharp pair of bent tweezers. The surface of the chip may have fragile air bridges and must not be touched with vacuum collet, tweezers, or fingers.

Mounting

The chip is back metallized and can be die mounted with AuSn eutectic preforms or with electrically conductive epoxy. Ensure that the mounting surface is clean and flat.

When attaching eutectic die, an 80/20 gold tin preform is recommended with a work surface temperature of 255°C and a tool temperature of 265°C. When hot 90/10 nitrogen/hydrogen gas is applied, ensure that tool tip temperature is 290°C. Do not expose the chip to a temperature greater than 320°C for more than 20 seconds. For attachment, no more than 3 seconds of scrubbing is required.

When attaching epoxy die, apply a minimum amount of epoxy to the mounting surface so that a thin epoxy fillet is observed around the perimeter of the chip once it is placed into position. Cure epoxy per the schedule of the manufacturer.

Wire Bonding

RF bonds made with two 1 mil wires are recommended. Ensure that these bonds are thermosonically bonded with a force of 40 grams to 60 grams. DC bonds of a 0.001" (0.025 mm) diameter, thermosonically bonded, are recommended. Make ball bonds with a force of 40 grams to 50 grams and wedge bonds with a force of 18 grams to 22 grams. Make all bonds with a nominal stage temperature of 150°C. Apply a minimum amount of ultrasonic energy to achieve reliable bonds. Make all bonds as short as possible, less than 12 mils (0.31 mm).

OUTLINE DIMENSIONS

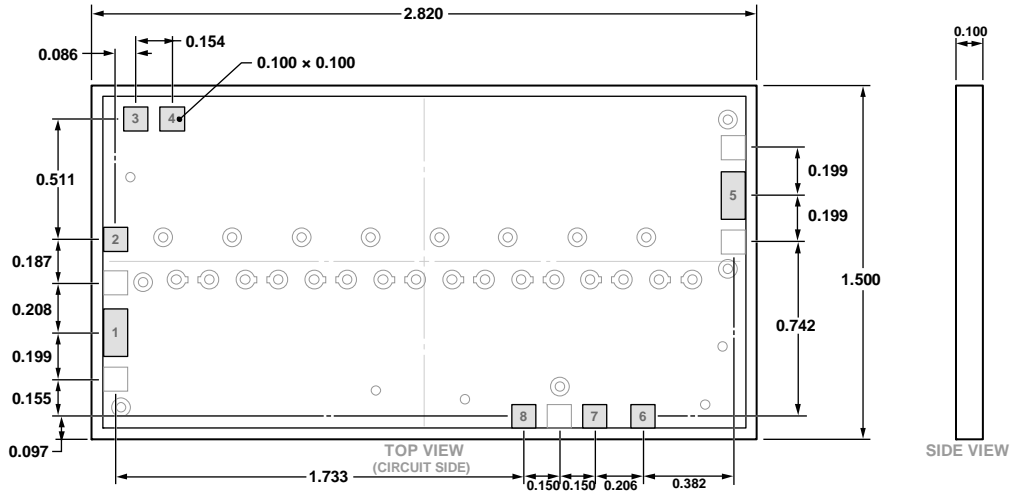

Figure 40. 8-Pad Bare Die [CHIP]
(C-8-6)
Dimensions shown in millimeter

DIE PACKAGING INFORMATION

Standard	Alternate Packaging
GP-2 (Gel Pack)	For alternate packaging information, contact Analog Devices, Inc.

ORDERING GUIDE

Model	Temperature Range	Package Description	Package Option
HMC930A	-55°C to +85°C	8-Pad Bare Die [CHIP]	C-8-6



Стандарт Электрон Связь

Мы молодая и активно развивающаяся компания в области поставок электронных компонентов. Мы поставляем электронные компоненты отечественного и импортного производства напрямую от производителей и с крупнейших складов мира.

Благодаря сотрудничеству с мировыми поставщиками мы осуществляем комплексные и плановые поставки широчайшего спектра электронных компонентов.

Собственная эффективная логистика и склад в обеспечивает надежную поставку продукции в точно указанные сроки по всей России.

Мы осуществляем техническую поддержку нашим клиентам и предпродажную проверку качества продукции. На все поставляемые продукты мы предоставляем гарантию .

Осуществляем поставки продукции под контролем ВП МО РФ на предприятия военно-промышленного комплекса России , а также работаем в рамках 275 ФЗ с открытием отдельных счетов в уполномоченном банке. Система менеджмента качества компании соответствует требованиям ГОСТ ISO 9001.

Минимальные сроки поставки, гибкие цены, неограниченный ассортимент и индивидуальный подход к клиентам являются основой для выстраивания долгосрочного и эффективного сотрудничества с предприятиями радиоэлектронной промышленности, предприятиями ВПК и научно-исследовательскими институтами России.

С нами вы становитесь еще успешнее!

Наши контакты:

Телефон: +7 812 627 14 35

Электронная почта: sales@st-electron.ru

Адрес: 198099, Санкт-Петербург,
Промышленная ул, дом № 19, литера Н,
помещение 100-Н Офис 331