

Ceramic Disc Capacitors, Class 1, Class 2, Low Loss (0.2 %), 500 V_{DC}, 1 kV_{DC}, 2 kV_{DC}, and 3 kV_{DC}

FEATURES

- High reliability
- Low losses
- High capacitance in small size
- Kinked leads
- Material categorization:
for definitions of compliance please see
www.vishay.com/doc?99912

**RoHS
COMPLIANT**
APPLICATIONS

In electronic circuits where low losses and high capacitance per volume are essential, for example:

- SMPS
- HF ballast
- Snubber and high voltage circuits

| QUICK REFERENCE DATA | | | | | | | |
|----------------------------|--------|------|------|------|------|------|------|
| DESCRIPTION | VALUE | | | | | | |
| Ceramic Class | 1 | | | 2 | | | |
| Ceramic Dielectric | S3N | | | Y5R | | | |
| Voltage (V _{DC}) | 1000 | 2000 | 3000 | 500 | 1000 | 2000 | 3000 |
| Min. Capacitance (pF) | 100 | 100 | 100 | 100 | 100 | 100 | 100 |
| Max. Capacitance (pF) | 2200 | 4700 | 2700 | 2700 | 4700 | 4700 | 2700 |
| Mounting | Radial | | | | | | |

MARKING

Marking indicates capacitance value and tolerance in accordance with “EIA 198” and voltage marks.

OPERATING TEMPERATURE RANGE

-30 °C to +125 °C

TEMPERATURE CHARACTERISTICS

Class 1: S3N

Class 2: Y5R

SECTIONAL SPECIFICATION

IEC 60384-9, EIA 198

EXAMPLES OF MARKING CODE

| | |
|--|--|
| Disc size (D _{max.}) ≤ 6.5 mm: | Disc size (D _{max.}) ≥ 7.5 mm: |
| | BC |
| RR = low loss with T.C. Y5R | RR |
| 101K | 102K |
| 2 kV | 3 kV |

Note

- Remark: no TC marking for S3N

AGING

Typical 0.5 % per time decade

Note

- The capacitors meet the essential requirements of “IEC 60384-9 and EIA 198”. Unless stated otherwise all electrical values apply at an ambient temperature of 25 °C ± 3 °C, at normal atmospheric conditions

DESIGN

The capacitors consist of a ceramic disc both sides of which are silver-plated. Connection leads are made of tinned copper having a diameter of 0.6 mm or 0.8 mm.

The capacitors are supplied with kinked leads and lead spacings of 5 mm or 7.5 mm and 10 mm. Encapsulation is made of epoxy-resin, flammable resistant in accordance with “UL 94 V-0”

CAPACITANCE RANGE

100 pF to 4700 pF

RATED DC VOLTAGE

500 V; 1 kV; 2 kV; 3 kV

DIELECTRIC STRENGTH

200 % of rated voltage

INSULATION RESISTANCE AT 500 V_{DC}

≥ 10 000 MΩ min.

TOLERANCE ON CAPACITANCE

± 10 %; ± 20 %

DISSIPATION FACTOR

0.2 % max.



ORDERING CODES

| DIELECTRIC S3N (1000 V _{DC} / 2000 V _{DC}) | | | | | | |
|---|----------------------|-----------------------|------------------------|----------------------|-----------------------|------------------------|
| CAP. (pF) | 1000 V _{DC} | | | 2000 V _{DC} | | |
| | ORDERING CODE | DIAMETER (mm max.) | THICKNESS (mm max.) | ORDERING CODE | DIAMETER (mm max.) | THICKNESS (mm max.) |
| 100 | F101K25S3NN6###R | 6.5 | 4.0 | F101K25S3NP6###R | 6.5 | 4.5 |
| 120 | F121K25S3NN6###R | 6.5 | 4.0 | F121K25S3NP6###R | 6.5 | 4.5 |
| 150 | F151K25S3NN6###R | 6.5 | 4.0 | F151K25S3NP6###R | 6.5 | 4.5 |
| 180 | F181K25S3NN6###R | 6.5 | 4.0 | F181K25S3NP6###R | 6.5 | 4.5 |
| 220 | F221K25S3NN6###R | 6.5 | 4.0 | F221K25S3NP6###R | 6.5 | 4.5 |
| 270 | F271K25S3NN6###R | 6.5 | 4.0 | F271K25S3NP6###R | 6.5 | 4.5 |
| 330 | F331K25S3NN6###R | 6.5 | 4.0 | F331K29S3NP6###R | 7.5 | 4.5 |
| 390 | F391K25S3NN6###R | 6.5 | 4.0 | F391K29S3NP6###R | 7.5 | 4.5 |
| 470 | F471K25S3NN6###R | 6.5 | 4.0 | F471K33S3NP6###R | 8.5 | 4.5 |
| 560 | F561K29S3NN6###R | 7.5 | 4.0 | F561K39S3NP6###R | 10.0 | 4.5 |
| 680 | F681K29S3NN6###R | 7.5 | 4.0 | F681K39S3NP6###R | 10.0 | 4.5 |
| 820 | F821K33S3NN6###R | 8.5 | 4.0 | F821K39S3NP6###R | 10.0 | 4.5 |
| 1000 | F102K33S3NN6###R | 8.5 | 4.0 | F102K43S3NP6###R | 11.0 | 4.5 |
| 1200 | F122K39S3NN6###R | 10.0 | 4.0 | F122K47S3NP63K7R | 12.0 | 4.5 |
| 1500 | F152K39S3NN6###R | 10.0 | 4.0 | F152K53S3NP63K7R | 13.5 | 4.5 |
| 1800 | F182K43S3NN6###R | 11.0 | 4.0 | F182K53S3NP63K7R | 13.5 | 4.5 |
| 2200 | F222K47S3NN6###R | 12.0 | 4.0 | F222K63S3NP63K7R | 16.0 | 4.5 |
| 2700 | / | / | / | F272K63S3NP63K7R | 16.0 | 4.5 |
| 3300 | / | / | / | F332K69S3NP63K7R | 17.5 | 4.5 |
| 3900 | / | / | / | F392K75S3NP83K0R | 19.0 | 4.5 |
| 4700 | / | / | / | F472K84S3NP83K0R | 21.5 | 4.5 |

| DIELECTRIC S3N (3000 V _{DC}) | | | |
|--|----------------------|-----------------------|------------------------|
| CAP. (pF) | 3000 V _{DC} | | |
| | ORDERING CODE | DIAMETER (mm max.) | THICKNESS (mm max.) |
| 100 | F101K25S3NR6###R | 6.5 | 5.5 |
| 120 | F121K25S3NR6###R | 6.5 | 5.5 |
| 150 | F151K29S3NR6###R | 7.5 | 5.5 |
| 180 | F181K29S3NR6###R | 7.5 | 5.5 |
| 220 | F221K29S3NR6###R | 7.5 | 5.5 |
| 270 | F271K29S3NR6###R | 7.5 | 5.5 |
| 330 | F331K33S3NR6###R | 8.5 | 5.5 |
| 390 | F391K39S3NR6###R | 10.0 | 5.5 |
| 470 | F471K39S3NR6###R | 10.0 | 5.5 |
| 560 | F561K39S3NR6###R | 10.0 | 5.5 |
| 680 | F681K43S3NR6###R | 11.0 | 5.5 |
| 820 | F821K53S3NR6###R | 13.5 | 5.5 |
| 1000 | F102K53S3NR6###R | 13.5 | 5.5 |
| 1200 | F122K59S3NR6###R | 15.0 | 5.5 |
| 1500 | F152K63S3NR6###R | 16.0 | 5.5 |
| 1800 | F182K69S3NR6###R | 17.5 | 5.5 |
| 2200 | F222K75S3NR83K0R | 19.0 | 5.5 |
| 2700 | F272K75S3NR83K0R | 19.0 | 5.5 |

Notes

- Lead diameter is 0.6 mm
- # 5th digit is capacitance tolerance code: ± 10 % = K; ± 20 % = M
- # 13th digit is packaging code: bulk = 3; reel = T; ammo = U
- # 14th digit is lead style code: L; J; K (J is valid for 1 kV only)
- # 15th digit is lead spacing code: 5.0 mm = 5; 6.4 mm = 6; 7.5 mm = 7; 10.0 mm = 0



| DIELECTRIC Y5R (500 V_{DC} / 1000 V_{DC}) | | | | | | |
|--|---------------------|-----------------------|------------------------|----------------------|-----------------------|------------------------|
| CAP. (pF) | 500 V _{DC} | | | 1000 V _{DC} | | |
| | ORDERING CODE | DIAMETER (mm max.) | THICKNESS (mm max.) | ORDERING CODE | DIAMETER (mm max.) | THICKNESS (mm max.) |
| 100 | F101K20Y5RL6###R | 5.0 | 3.5 | F101K25Y5RN6###R | 6.5 | 4.0 |
| 120 | F121K20Y5RL6###R | 5.0 | 3.5 | F121K25Y5RN6###R | 6.5 | 4.0 |
| 150 | F151K20Y5RL6###R | 5.0 | 3.5 | F151K25Y5RN6###R | 6.5 | 4.0 |
| 180 | F181K20Y5RL6###R | 5.0 | 3.5 | F181K25Y5RN6###R | 6.5 | 4.0 |
| 220 | F221K20Y5RL6###R | 5.0 | 3.5 | F221K25Y5RN6###R | 6.5 | 4.0 |
| 270 | F271K20Y5RL6###R | 5.0 | 3.5 | F271K29Y5RN6###R | 7.5 | 4.0 |
| 330 | F331K20Y5RL6###R | 5.0 | 3.5 | F331K29Y5RN6###R | 7.5 | 4.0 |
| 390 | F391K25Y5RL6###R | 6.5 | 3.5 | F391K29Y5RN6###R | 7.5 | 4.0 |
| 470 | F471K25Y5RL6###R | 6.5 | 3.5 | F471K29Y5RN6###R | 7.5 | 4.0 |
| 560 | F561K25Y5RL6###R | 6.5 | 3.5 | F561K33Y5RN6###R | 8.5 | 4.0 |
| 680 | F681K25Y5RL6###R | 6.5 | 3.5 | F681K33Y5RN6###R | 8.5 | 4.0 |
| 820 | F821K29Y5RL6###R | 7.5 | 3.5 | F821K39Y5RN6###R | 10.0 | 4.0 |
| 1000 | F102K29Y5RL6###R | 7.5 | 3.5 | F102K39Y5RN6###R | 10.0 | 4.0 |
| 1200 | F122K33Y5RL6###R | 8.5 | 3.5 | F122K43Y5RN6###R | 11.0 | 4.0 |
| 1500 | F152K33Y5RL6###R | 8.5 | 3.5 | F152K43Y5RN6###R | 11.0 | 4.0 |
| 1800 | F182K39Y5RL6###R | 10.0 | 3.5 | F182K47Y5RN6###R | 12.0 | 4.0 |
| 2200 | F222K43Y5RL63J7R | 11.0 | 3.5 | F222K53Y5RN6###R | 13.5 | 4.0 |
| 2700 | F272K47Y5RL63J7R | 12.0 | 3.5 | F272K53Y5RN6###R | 13.5 | 4.0 |
| 3300 | / | / | / | F332K69Y5RN6###R | 17.5 | 4.0 |
| 3900 | / | / | / | F392K69Y5RN83K0R | 17.5 | 4.0 |
| 4700 | / | / | / | F472K75Y5RN83K0R | 19.0 | 4.0 |

| DIELECTRIC Y5R (2000 V_{DC} / 3000 V_{DC}) | | | | | | |
|---|----------------------|-----------------------|------------------------|----------------------|-----------------------|------------------------|
| CAP. (pF) | 2000 V _{DC} | | | 3000 V _{DC} | | |
| | ORDERING CODE | DIAMETER (mm max.) | THICKNESS (mm max.) | ORDERING CODE | DIAMETER (mm max.) | THICKNESS (mm max.) |
| 100 | F101K25Y5RP6###R | 6.5 | 5.0 | F101K33Y5RR6###R | 8.5 | 5.5 |
| 120 | F121K25Y5RP6###R | 6.5 | 5.0 | F121K33Y5RR6###R | 8.5 | 5.5 |
| 150 | F151K25Y5RP6###R | 6.5 | 5.0 | F151K33Y5RR6###R | 8.5 | 5.5 |
| 180 | F181K29Y5RP6###R | 7.5 | 5.0 | F181K33Y5RR6###R | 8.5 | 5.5 |
| 220 | F221K29Y5RP6###R | 7.5 | 5.0 | F221K33Y5RR6###R | 8.5 | 5.5 |
| 270 | F271K29Y5RP6###R | 7.5 | 5.0 | F271K33Y5RR6###R | 8.5 | 5.5 |
| 330 | F331K29Y5RP6###R | 7.5 | 5.0 | F331K33Y5RR6###R | 8.5 | 5.5 |
| 390 | F391K33Y5RP6###R | 8.5 | 5.0 | F391K39Y5RR6###R | 10.0 | 5.5 |
| 470 | F471K33Y5RP6###R | 8.5 | 5.0 | F471K39Y5RR6###R | 10.0 | 5.5 |
| 560 | F561K39Y5RP6###R | 10.0 | 5.0 | F561K43Y5RR6###R | 11.0 | 5.5 |
| 680 | F681K39Y5RP6###R | 10.0 | 5.0 | F681K43Y5RR6###R | 11.0 | 5.5 |
| 820 | F821K43Y5RP6###R | 11.0 | 5.0 | F821K53Y5RR6###R | 13.5 | 5.5 |
| 1000 | F102K43Y5RP6###R | 11.0 | 5.0 | F102K53Y5RR6###R | 13.5 | 5.5 |
| 1200 | F122K47Y5RP6###R | 12.0 | 5.0 | F122K59Y5RR6###R | 15.0 | 5.5 |
| 1500 | F152K53Y5RP6###R | 13.5 | 5.0 | F152K59Y5RR6###R | 15.0 | 5.5 |
| 1800 | F182K59Y5RP6###R | 15.0 | 5.0 | F182K75Y5RR6###R | 19.0 | 5.5 |
| 2200 | F222K69Y5RP83K0R | 17.5 | 5.0 | F222K75Y5RR83K0R | 19.0 | 5.5 |
| 2700 | F272K75Y5RP83K0R | 19.0 | 5.0 | F272K84Y5RR83K0R | 21.0 | 5.5 |
| 3300 | F332K75Y5RP83K0R | 19.0 | 5.0 | / | / | / |
| 3900 | F392K75Y5RP83K0R | 19.0 | 5.0 | / | / | / |
| 4700 | F472K96Y5RP83K0R | 24.5 | 5.0 | / | / | / |

Notes

- Lead diameter is 0.6 mm
- # 5th digit is capacitance tolerance code: ± 10 % = K; ± 20 % = M
- # 13th digit is packaging code: bulk = 3; reel = T; ammo = U
- # 14th digit is lead style code: L; J; K (J is valid for 1 kV only)
- # 15th digit is lead spacing code: 5.0 mm = 5; 6.4 mm = 6; 7.5 mm = 7; 10.0 mm = 0

| PACKAGING | | | | | |
|---------------------------------|-----------|-----------------|----------------------------|----------------|--------------------------|
| PACKAGING TYPE | SIZE CODE | LEAD SPACE (mm) | VOLTAGE (V _{DC}) | SPQ | BOX DIMENSIONS L x W x H |
| Bulk (long lead L ≥ 25.4 mm) | 20 to 25 | all | all | 1000 | 245 x 120 x 65 |
| | 29 to 39 | | | 1000 | |
| | 43 to 47 | | | 1000 | |
| | 53 to 75 | | | 500 | |
| | 84 to 96 | | | 250 | |
| Tape and reel | ≤ 47 | ≤ 6.4 | < 500 | 2500 | 370 x 370 x 60 |
| | | | 500 ≤ WV ≤ 2000 | 2000 | |
| | | | 3000 | 1000 | |
| | ≥ 7.5 | all | 1000 | | |
| ≥ 53 | all | all | 1000 | | |
| Ammopack | ≤ 47 | ≤ 6.4 | < 500 | 2000 | 335 x 240 x 50 |
| | | | 500 ≤ WV < 2000 | 2000 | 335 x 290 x 50 |
| | | | 2000 and 3000 | 1500 | 360 x 330 x 55 |
| | ≥ 7.5 | all | 1500 | 360 x 330 x 55 | |
| | ≥ 53 | all | all | 1500 | 335 x 290 x 50 |

Note

- The capacitors are supplied in bulk packaging (cardboard boxes), in tape on reel or in ammpack

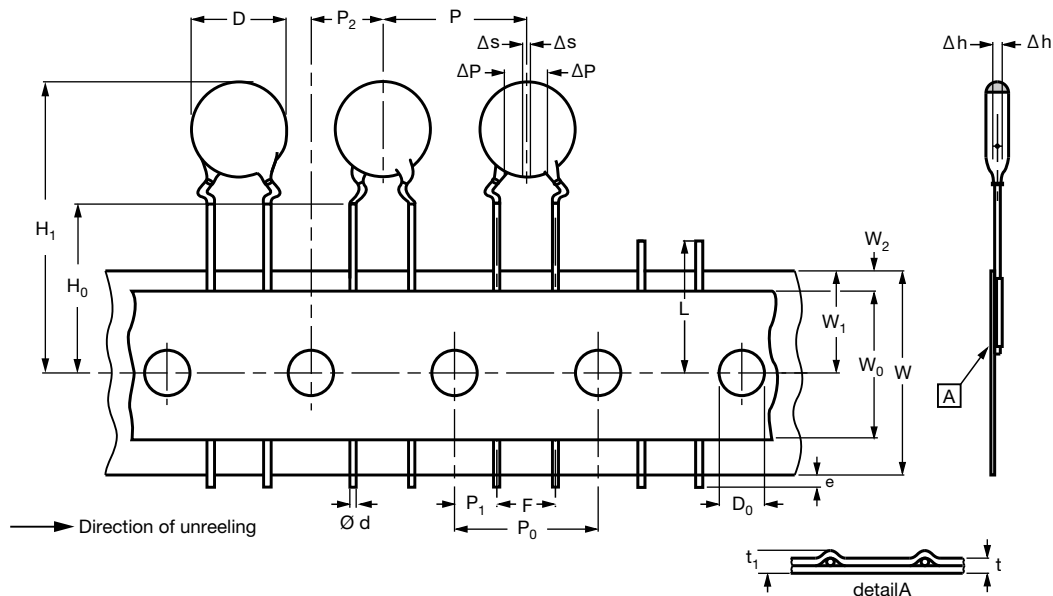

Kinked capacitors on tape, lead spacing 5.0 mm (0.2) or 7.5 mm (0.3)

| DIMENSIONS OF TAPE | | | |
|-------------------------------|--------------------------------------|---------------------------------|---------------------------------|
| SYMBOL | PARAMETER | DIMENSIONS (mm) | |
| | | FEED-HOLE PITCH $P_0 = 12.7$ | FEED-HOLE PITCH $P_0 = 15.0$ |
| D | Body diameter | 11.0 max. | 14.0 max. |
| d | Lead diameter | 0.6 ± 0.05 | 0.6 ± 0.05 |
| P ⁽¹⁾ | Pitch between capacitors | 12.7 ± 1.0 | 15.0 ± 1.0 |
| P_0 | Feed-hole pitch | 12.7 ± 0.3 | 15.0 ± 0.3 |
| ΔP | Plane deviation | 1.0 max. | 1.0 max. |
| P ₁ ⁽²⁾ | Feed-hole center to lead center | 3.85 ± 0.7 | 3.75 ± 0.7 |
| P ₂ ⁽²⁾ | Feed-hole center to component center | 6.35 ± 1.3 | 7.5 ± 1.5 |
| F | Lead spacing | $5.0 + 0.6/- 0.4$ | $7.5 + 0.6/- 0.4$ |
| Δh | Component alignment | 0 ± 1.0 | 0 ± 1.0 |
| W | Tape width | $18.0 + 1.0/- 0.5$ | $18.0 + 1.0/- 0.5$ |
| W ₀ | Hold-down tape width | 5.0 min. | 5.0 min. |
| W ₁ | Hole position | $9.0 + 0.75/- 0.5$ | $9.0 + 0.75/- 0.5$ |
| W ₂ | Hold-down tape margin | 3.0 max. | 3.0 max. |
| H ₀ | Height to seating plane | 16.0 ± 0.5 | 16.0 ± 0.5 |
| H ₁ | Maximum component height | 32.0 | 40.0 |
| e | Lead end protrusion | 1.0 max. | 1.0 max. |
| L | Maximum length of snapped lead | 11.0 | 11.0 |
| D ₀ | Feed-hole diameter | 4.0 ± 0.2 | 4.0 ± 0.2 |
| t | Total tape thickness | 0.9 max. | 0.9 max. |
| t ₁ | Maximum thickness of tape and wires | 1.5 max. | 1.5 max. |

Notes

 (1) Cumulative pitch error: $\pm \leq 1$ mm/20 pitches

(2) Obliquity maximum 3°

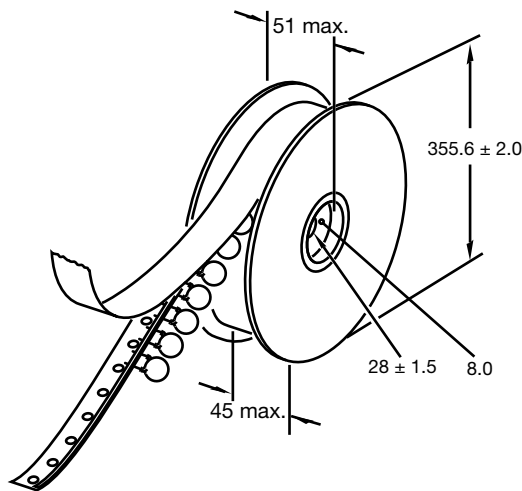
REEL AND TAPE DATA in millimeters

Reel with capacitors on tape

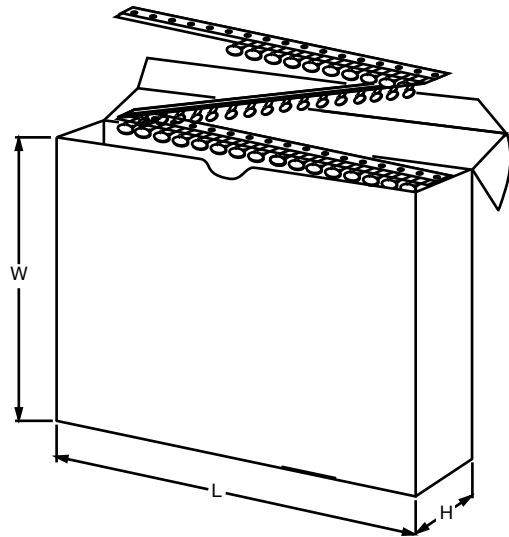

Ammpack with capacitors on tape

| DIMENSIONS OF AMMOPACK | | | |
|------------------------|-----------------------------------|--------------------|------|
| PARAMETER | DISC SIZE (D _{MAX.}) | | UNIT |
| | 6.5 mm to 11.0 mm | 12.0 mm to 13.5 mm | |
| Taping pitch | 12.7 | 15.0 | mm |
| L | 335 | 360 | mm |
| W | 290 | 330 | mm |
| H | 50 | 55 | mm |

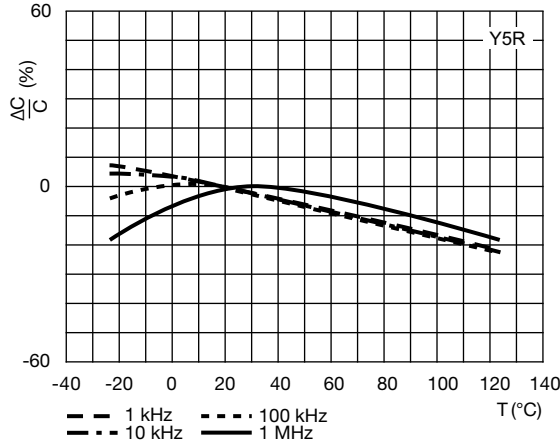

Typical capacitance change as a function of temperature and frequency

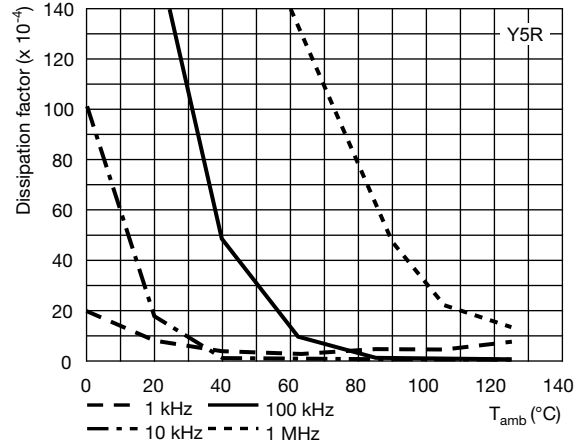

Typical dissipation factor as a function of temperature and frequency

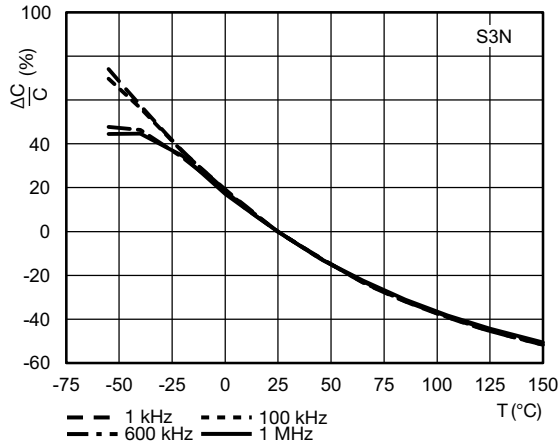

Typical capacitance change as a function of temperature and frequency

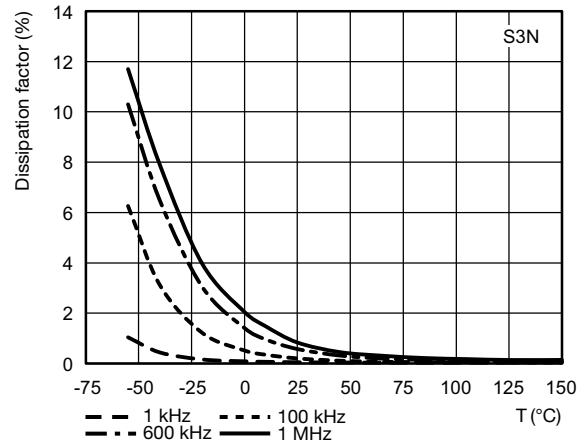

Typical dissipation factor as a function of temperature and frequency

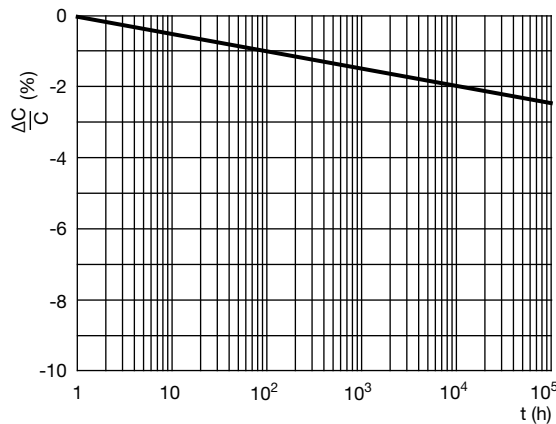

Aging rate as a function of time



Disclaimer

ALL PRODUCT, PRODUCT SPECIFICATIONS AND DATA ARE SUBJECT TO CHANGE WITHOUT NOTICE TO IMPROVE RELIABILITY, FUNCTION OR DESIGN OR OTHERWISE.

Vishay Intertechnology, Inc., its affiliates, agents, and employees, and all persons acting on its or their behalf (collectively, "Vishay"), disclaim any and all liability for any errors, inaccuracies or incompleteness contained in any datasheet or in any other disclosure relating to any product.

Vishay makes no warranty, representation or guarantee regarding the suitability of the products for any particular purpose or the continuing production of any product. To the maximum extent permitted by applicable law, Vishay disclaims (i) any and all liability arising out of the application or use of any product, (ii) any and all liability, including without limitation special, consequential or incidental damages, and (iii) any and all implied warranties, including warranties of fitness for particular purpose, non-infringement and merchantability.

Statements regarding the suitability of products for certain types of applications are based on Vishay's knowledge of typical requirements that are often placed on Vishay products in generic applications. Such statements are not binding statements about the suitability of products for a particular application. It is the customer's responsibility to validate that a particular product with the properties described in the product specification is suitable for use in a particular application. Parameters provided in datasheets and / or specifications may vary in different applications and performance may vary over time. All operating parameters, including typical parameters, must be validated for each customer application by the customer's technical experts. Product specifications do not expand or otherwise modify Vishay's terms and conditions of purchase, including but not limited to the warranty expressed therein.

Except as expressly indicated in writing, Vishay products are not designed for use in medical, life-saving, or life-sustaining applications or for any other application in which the failure of the Vishay product could result in personal injury or death. Customers using or selling Vishay products not expressly indicated for use in such applications do so at their own risk. Please contact authorized Vishay personnel to obtain written terms and conditions regarding products designed for such applications.

No license, express or implied, by estoppel or otherwise, to any intellectual property rights is granted by this document or by any conduct of Vishay. Product names and markings noted herein may be trademarks of their respective owners.



Стандарт Электрон Связь

Мы молодая и активно развивающаяся компания в области поставок электронных компонентов. Мы поставляем электронные компоненты отечественного и импортного производства напрямую от производителей и с крупнейших складов мира.

Благодаря сотрудничеству с мировыми поставщиками мы осуществляем комплексные и плановые поставки широчайшего спектра электронных компонентов.

Собственная эффективная логистика и склад в обеспечивает надежную поставку продукции в точно указанные сроки по всей России.

Мы осуществляем техническую поддержку нашим клиентам и предпродажную проверку качества продукции. На все поставляемые продукты мы предоставляем гарантию .

Осуществляем поставки продукции под контролем ВП МО РФ на предприятия военно-промышленного комплекса России , а также работаем в рамках 275 ФЗ с открытием отдельных счетов в уполномоченном банке. Система менеджмента качества компании соответствует требованиям ГОСТ ISO 9001.

Минимальные сроки поставки, гибкие цены, неограниченный ассортимент и индивидуальный подход к клиентам являются основой для выстраивания долгосрочного и эффективного сотрудничества с предприятиями радиоэлектронной промышленности, предприятиями ВПК и научно-исследовательскими институтами России.

С нами вы становитесь еще успешнее!

Наши контакты:

Телефон: +7 812 627 14 35

Электронная почта: sales@st-electron.ru

Адрес: 198099, Санкт-Петербург,
Промышленная ул, дом № 19, литера Н,
помещение 100-Н Офис 331