

# TPS2211

## SINGLE-SLOT PC CARD POWER INTERFACE SWITCH FOR PARALLEL PCMCIA CONTROLLERS

SLVS156E – JULY 1997 – REVISED JANUARY 2001

- Fully Integrated  $V_{CC}$  and  $V_{pp}$  Switching for Single-Slot PC Card™ Interface
- Low  $r_{DS(on)}$  (90-m $\Omega$  5-V  $V_{CC}$  Switch and 3.3-V  $V_{CC}$  Switch)
- Compatible With Controllers From Cirrus, Ricoh, O<sub>2</sub>Micro, Intel, and Texas Instruments
- 3.3-V Low-Voltage Mode
- Meets PC Card Standards
- 12-V Supply Can Be Disabled Except During 12-V Flash Programming
- Short-Circuit and Thermal Protection
- Space-Saving 16-Pin SSOP (DB)
- Compatible With 3.3-V, 5-V, and 12-V PC Cards
- Break-Before-Make Switching

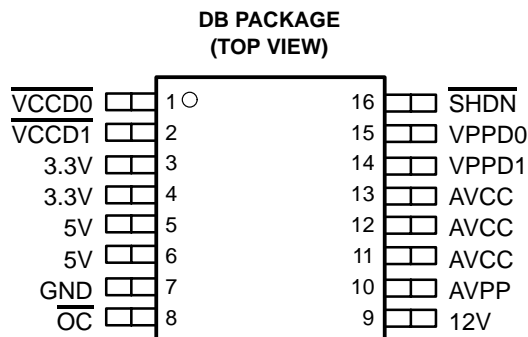

### description

The TPS2211 PC Card power-interface switch provides an integrated power-management solution for a single PC Card. All of the discrete power MOSFETs, a logic section, current limiting, and thermal protection for PC Card control are combined on a single integrated circuit, using the Texas Instruments LinBiCMOS™ process. The circuit allows the distribution of 3.3-V, 5-V, and/or 12-V card power, and is compatible with many PCMCIA controllers. The current-limiting feature eliminates the need for fuses, which reduces component count and improves reliability. Current-limit reporting can help the user isolate a system fault to the PC Card.

The TPS2211 features a 3.3-V low-voltage mode that allows for 3.3-V switching without the need for 5 V. Bias power can be derived from either the 3.3-V or 5-V inputs. This facilitates low-power system designs such as sleep mode and pager mode where only 3.3 V is available.

End equipment for the TPS2211 includes notebook computers, desktop computers, personal digital assistants (PDAs), digital cameras, and bar-code scanners.

#### AVAILABLE OPTIONS

$T_A$	PACKAGED DEVICE	CHIP FORM (Y)
	SMALL OUTLINE (DB)	
-40°C to 85°C	TPS2211DBR	TPS2211Y

The DB package is only available taped and reeled, indicated by the R suffix on the device type.



Please be aware that an important notice concerning availability, standard warranty, and use in critical applications of Texas Instruments semiconductor products and disclaimers thereto appears at the end of this data sheet.

PC Card is a trademark of PCMCIA (Personal Computer Memory Card International Association).  
LinBiCMOS is a trademark of Texas Instruments Incorporated.

PRODUCTION DATA information is current as of publication date. Products conform to specifications per the terms of Texas Instruments standard warranty. Production processing does not necessarily include testing of all parameters.



POST OFFICE BOX 655303 • DALLAS, TEXAS 75265

Copyright © 2001, Texas Instruments Incorporated

# TPS2211 SINGLE-SLOT PC CARD POWER INTERFACE SWITCH FOR PARALLEL PCMCIA CONTROLLERS

SLVS156E – JULY 1997 – REVISED JANUARY 2001

## typical PC-card power-distribution application

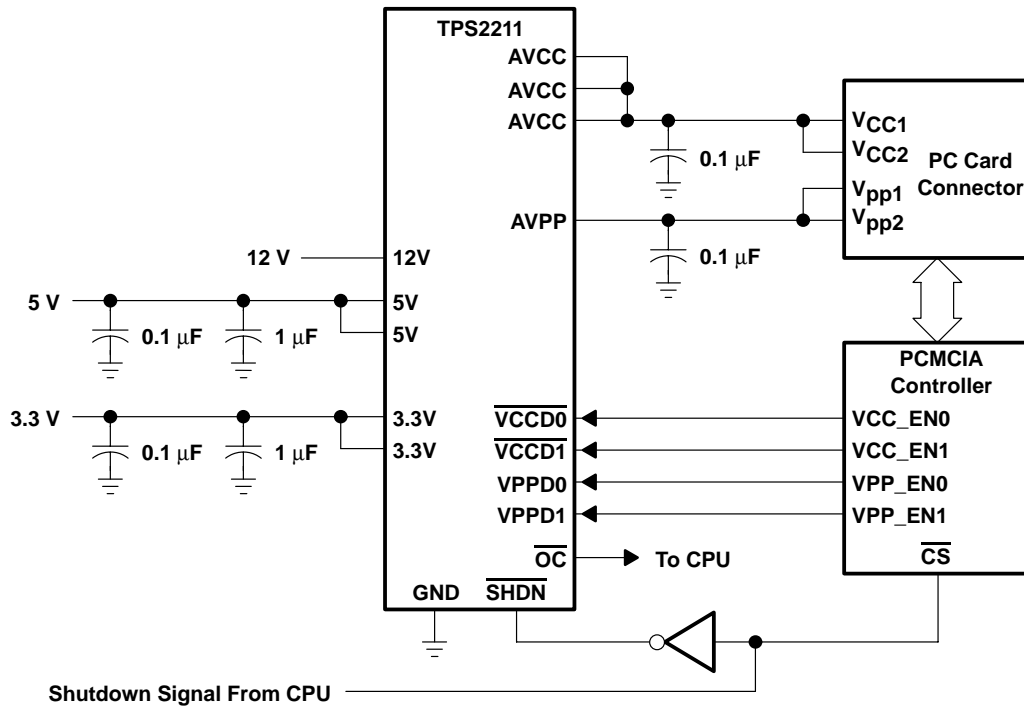

# TPS2211 SINGLE-SLOT PC CARD POWER INTERFACE SWITCH FOR PARALLEL PCMCIA CONTROLLERS

SLVS156E – JULY 1997 – REVISED JANUARY 2001

## TPS2211Y chip information

This chip, when properly assembled, displays characteristics similar to those of the TPS2211. Thermal compression or ultrasonic bonding may be used on the doped-aluminum bonding pads. The chips may be mounted with conductive epoxy or a gold-silicon preform.

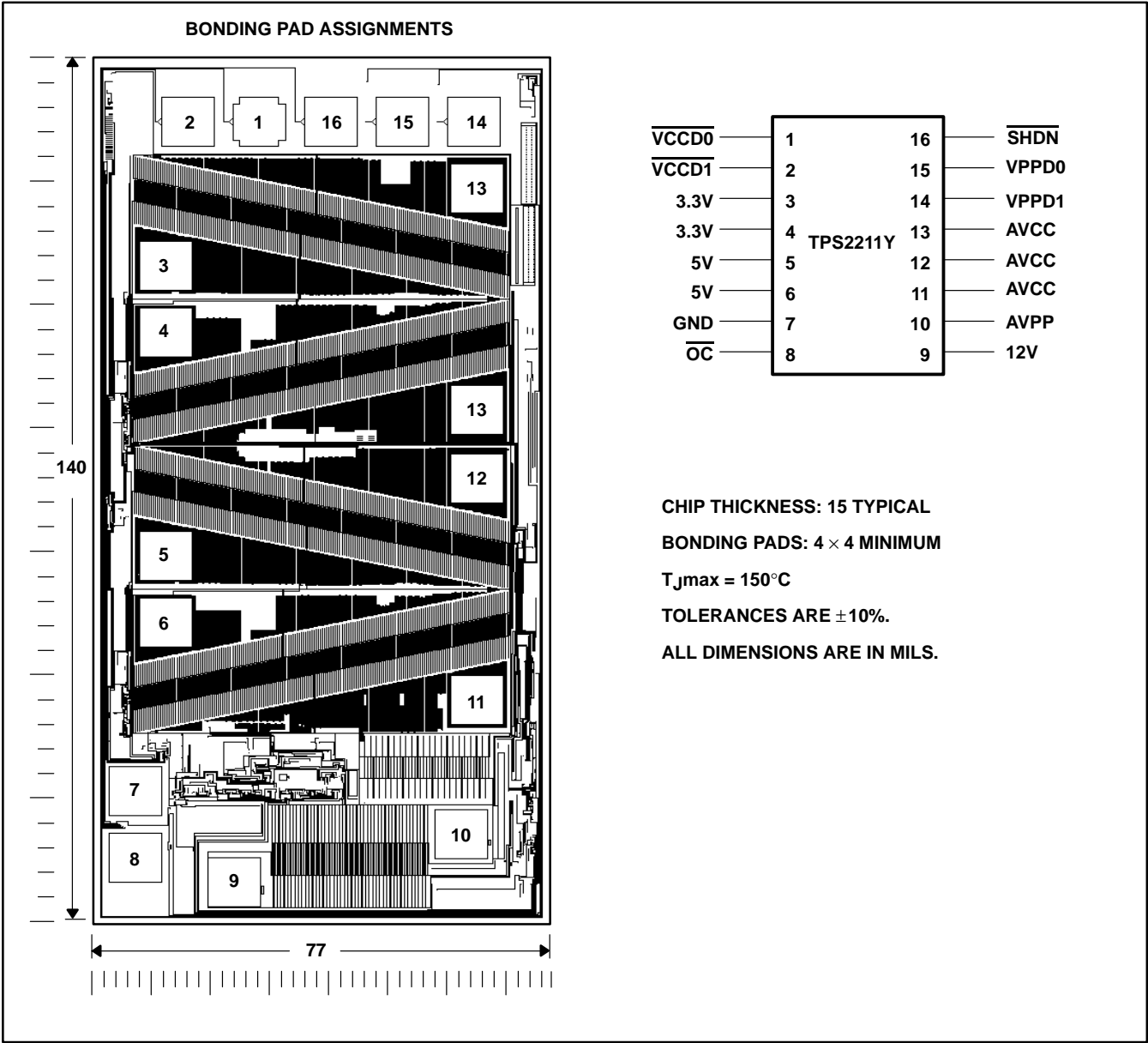

**TPS2211**  
**SINGLE-SLOT PC CARD POWER INTERFACE SWITCH**  
**FOR PARALLEL PCMCIA CONTROLLERS**

SLVS156E – JULY 1997 – REVISED JANUARY 2001

**Terminal Functions**

TERMINAL NAME	NO.	I/O	DESCRIPTION
3.3V	3, 4	I	3.3-V V <sub>CC</sub> input for card power and/or chip power if 5 V is not present
5V	5, 6	I	5-V V <sub>CC</sub> input for card power and/or chip power
12V	9	I	12-V V <sub>pp</sub> input card power
AVCC	11, 12, 13	O	Switched output that delivers 0 V, 3.3-V, 5-V, or high impedance to card
AVPP	10	O	Switched output that delivers 0 V 3.3-V, 5-V, 12-V, or high impedance to card
GND	7		Ground
$\overline{OC}$	8	O	Logic-level overcurrent reporting output that goes low when an overcurrent conditions exists
$\overline{SHDN}$	16	I	Logic input that shuts down the TPS2211 and sets all power outputs to high-impedance state
VCCD0	1	I	Logic input that controls voltage of AVCC (see control-logic table)
VCCD1	2	I	Logic input that controls voltage of AVCC (see control-logic table)
VPPD0	15	I	Logic input that controls voltage of AVPP (see control-logic table)
VPPD1	14	I	Logic input that controls voltage of AVPP (see control-logic table)

**absolute maximum ratings over operating free-air temperature (unless otherwise noted)†**

Input voltage range for card power:	V <sub>I(5V)</sub> .....	-0.3 V to 7 V
	V <sub>I(3.3V)</sub> .....	-0.3 V to 7 V
	V <sub>I(12V)</sub> .....	-0.3 V to 14 V
Logic input voltage .....		-0.3 V to 7 V
Continuous total power dissipation .....		See Dissipation Rating Table
Output current (each card):	I <sub>O(VCC)</sub> .....	internally limited
	I <sub>O(VPP)</sub> .....	internally limited
Operating virtual junction temperature range, T <sub>J</sub> .....		-40°C to 150°C
Operating free-air temperature range, T <sub>A</sub> .....		-40°C to 85°C
Storage temperature range, T <sub>stg</sub> .....		-55°C to 150°C
Lead temperature 1.6 mm (1/16 inch) from case for 10 seconds .....		260°C

† Stresses beyond those listed under “absolute maximum ratings” may cause permanent damage to the device. These are stress ratings only, and functional operation of the device at these or any other conditions beyond those indicated under “recommended operating conditions” is not implied. Exposure to absolute-maximum-rated conditions for extended periods may affect device reliability.

**DISSIPATION RATING TABLE**

PACKAGE	T <sub>A</sub> ≤ 25°C POWER RATING	DERATING FACTOR ABOVE T <sub>A</sub> = 25°C	T <sub>A</sub> = 70°C POWER RATING	T <sub>A</sub> = 85°C POWER RATING
DB	775 mW	6.2 mW/°C	496 mW	403 mW

These devices are mounted on an FR4 board with no special thermal considerations.

**recommended operating conditions**

		MIN	MAX	UNIT
Input voltage, V <sub>I</sub>	V <sub>I(5V)</sub>	0	5.25	V
	V <sub>I(3.3V)</sub>	0	5.25	V
	V <sub>I(12V)</sub>	0	13.5	V
Output current	I <sub>O(AVCC)</sub>		1	A
	I <sub>O(AVPP)</sub>		150	mA
Operating virtual junction temperature, T <sub>J</sub>		-40	125	°C



# TPS2211

## SINGLE-SLOT PC CARD POWER INTERFACE SWITCH FOR PARALLEL PCMCIA CONTROLLERS

SLVS156E – JULY 1997 – REVISED JANUARY 2001

electrical characteristics,  $T_A = -40^\circ\text{C}$  to  $85^\circ\text{C}$  (unless otherwise noted)

### power switch

PARAMETER		TEST CONDITIONS†	TPS2211			UNIT
			MIN	TYP	MAX	
Switch resistance	5 V to AVCC	$V_{I(5V)} = 5\text{ V}$		50	90	m $\Omega$
	3.3 V to AVCC	$V_{I(5V)} = 5\text{ V}, V_{I(3.3V)} = 3.3\text{ V}$		48	90	
	3.3 V to AVCC	$V_{I(5V)} = 0\text{ V}, V_{I(3.3V)} = 3.3\text{ V}$		48	90	
	5 V to AVPP	$T_J = 25^\circ\text{C}$			6	$\Omega$
	3.3 V to AVPP	$T_J = 25^\circ\text{C}$			6	
	12 V to AVPP	$T_J = 25^\circ\text{C}$			1	
$V_{O(AVPP)}$	Clamp low voltage	$I_{pp}$ at 10 mA			0.8	V
$V_{O(AVCC)}$	Clamp low voltage	$I_{CC}$ at 10 mA			0.8	V
$I_{lkg}$	Leakage current	$I_{pp}$ high-impedance state	$T_A = 25^\circ\text{C}$	1	10	$\mu\text{A}$
			$T_A = 85^\circ\text{C}$		50	
	$I_{CC}$ high-impedance state	$T_A = 25^\circ\text{C}$	1	10		
		$T_A = 85^\circ\text{C}$		50		
$I_I$	Input current	$V_{I(5V)} = 5\text{ V}$	$V_{O(AVCC)} = 5\text{ V}, V_{O(AVPP)} = 12\text{ V}$	40	150	$\mu\text{A}$
		$V_{I(5V)} = 0\text{ V}, V_{I(3.3V)} = 3.3\text{ V}$	$V_{O(AVCC)} = 3.3\text{ V}, V_{O(AVPP)} = 12\text{ V}$	40	150	
		Shutdown mode	$V_{O(AVCC)} = V_{O(AVPP)} = \text{Hi-Z}$		1	
$I_{OS}$	Short-circuit output-current limit	$I_{O(AVCC)}$	$T_J = 85^\circ\text{C}$ , output powered into a short to GND	1	2.2	A
		$I_{O(AVPP)}$		120	400	mA

† Pulse-testing techniques maintain junction temperature close to ambient temperature; thermal effects must be taken into account separately.

### logic section

PARAMETER	TEST CONDITIONS†	TPS2211		UNIT
		MIN	MAX	
Logic input current			1	$\mu\text{A}$
Logic input high level		2		V
Logic input low level			0.8	V
Logic output high level	$V_{I(5V)} = 5\text{ V}, I_O = 1\text{ mA}$	$V_{I(5V)} - 0.4$		V
	$V_{I(5V)} = 0\text{ V}, I_O = 1\text{ mA}, V_{I(3.3V)} = 3.3\text{ V}$	$V_{I(3.3V)} - 0.4$		
Logic output low level	$I_O = 1\text{ mA}$		0.4	V

† Pulse-testing techniques maintain junction temperature close to ambient temperature; thermal effects must be taken into account separately.

**TPS2211**  
**SINGLE-SLOT PC CARD POWER INTERFACE SWITCH**  
**FOR PARALLEL PCMCIA CONTROLLERS**

SLVS156E – JULY 1997 – REVISED JANUARY 2001

**electrical characteristics,  $T_A = 25^\circ\text{C}$  (unless otherwise noted)**

**power switch**

PARAMETER		TEST CONDITIONS†	TPS2211Y			UNIT
			MIN	TYP	MAX	
Switch resistance	5 V to AVCC	$V_{I(5V)} = 5\text{ V}$	50			m $\Omega$
	3.3 V to AVCC	$V_{I(5V)} = 5\text{ V}, V_{I(3.3V)} = 3.3\text{ V}$	48			
	3.3 V to AVCC	$V_{I(5V)} = 0\text{ V}, V_{I(3.3V)} = 3.3\text{ V}$	48			
	5 V to AVPP	$T_J = 25^\circ\text{C}$	4.3			$\Omega$
	3.3 V to AVPP	$T_J = 25^\circ\text{C}$	4.3			
	12 V to AVPP	$T_J = 25^\circ\text{C}$	0.5			
$V_{O(AVPP)}$	Clamp low voltage	$I_{pp}$ at 10 mA	0.28			V
$V_{O(AVCC)}$	Clamp low voltage	$I_{pp}$ at 10 mA	0.28			V
$I_{lkg}$	Leakage current	$I_{pp}$ high-impedance state	1			$\mu\text{A}$
		$I_{CC}$ high-impedance state	1			
$I_I$	Input current	$V_I = 5\text{ V}$	$V_{O(AVCC)} = 5\text{ V}, V_{O(AVPP)} = 12\text{ V}$			$\mu\text{A}$
		$V_{I(5V)} = 5\text{ V}, V_{I(3.3V)} = 3.3\text{ V}$	$V_{O(AVCC)} = 3.3\text{ V}, V_{O(AVPP)} = 12\text{ V}$			

† Pulse-testing techniques maintain junction temperature close to ambient temperature; thermal effects must be taken into account separately.

**switching characteristics‡**

PARAMETER		TEST CONDITIONS§	TPS2211, TPS2211Y			UNIT
			MIN	TYP	MAX	
$t_r$	Rise times, output	$V_{O(AVCC)}$	2.8			ms
		$V_{O(AVPP)}$	6.4			
$t_f$	Fall times, output	$V_{O(AVCC)}$	4.5			
		$V_{O(AVPP)}$	12			
$t_{pd}$	Propagation delay (see Figure1)	$V_I(VPPD0)$ to $V_{O(AVPP)}$	$t_{on}$	6.8		ms
			$t_{off}$	18		
		$V_I(\overline{VCCD1})$ to $V_{O(AVCC)}$ (3.3V)	$t_{on}$	4		
			$t_{off}$	17		
		$V_I(\overline{VCCD0})$ to $V_{O(AVCC)}$ (5V)	$t_{on}$	6.6		
			$t_{off}$	17		

‡ Switching Characteristics are with  $C_L = 150\ \mu\text{F}$ .

§ Refer to Parameter Measurement Information



**TPS2211**  
**SINGLE-SLOT PC CARD POWER INTERFACE SWITCH**  
**FOR PARALLEL PCMCIA CONTROLLERS**

SLVS156E – JULY 1997 – REVISED JANUARY 2001

**PARAMETER MEASUREMENT INFORMATION**

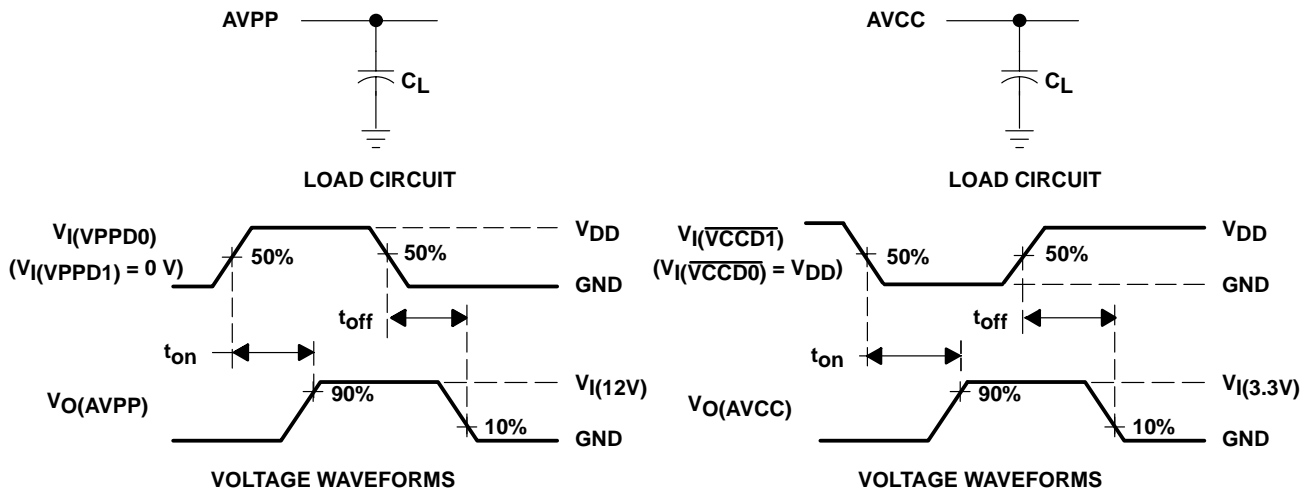

**Figure 1. Test Circuits and Voltage Waveforms**

**Table of Timing Diagrams**

	FIGURE
AVCC Propagation Delay and Rise Time With 1- $\mu$ F Load, 3.3-V Switch	2
AVCC Propagation Delay and Fall Time With 1- $\mu$ F Load, 3.3-V Switch	3
AVCC Propagation Delay and Rise Time With 150- $\mu$ F Load, 3.3-V Switch	4
AVCC Propagation Delay and Fall Time With 150- $\mu$ F Load, 3.3-V Switch	5
AVCC Propagation Delay and Rise Time With 1- $\mu$ F Load, 5-V Switch	6
AVCC Propagation Delay and Fall Time With 1- $\mu$ F Load, 5-V Switch	7
AVCC Propagation Delay and Rise Time With 150- $\mu$ F Load, 5-V Switch	8
AVCC Propagation Delay and Fall Time With 150- $\mu$ F Load, 5-V Switch	9
AVPP Propagation Delay and Rise Time With 1- $\mu$ F Load, 12-V Switch	10
AVPP Propagation Delay and Fall Time With 1- $\mu$ F Load, 12-V Switch	11
AVPP Propagation Delay and Rise Time With 150- $\mu$ F Load, 12-V Switch	12
AVPP Propagation Delay and Fall Time With 150- $\mu$ F Load, 12-V Switch	13

**TPS2211**  
**SINGLE-SLOT PC CARD POWER INTERFACE SWITCH**  
**FOR PARALLEL PCMCIA CONTROLLERS**

SLVS156E – JULY 1997 – REVISED JANUARY 2001

**PARAMETER MEASUREMENT INFORMATION**

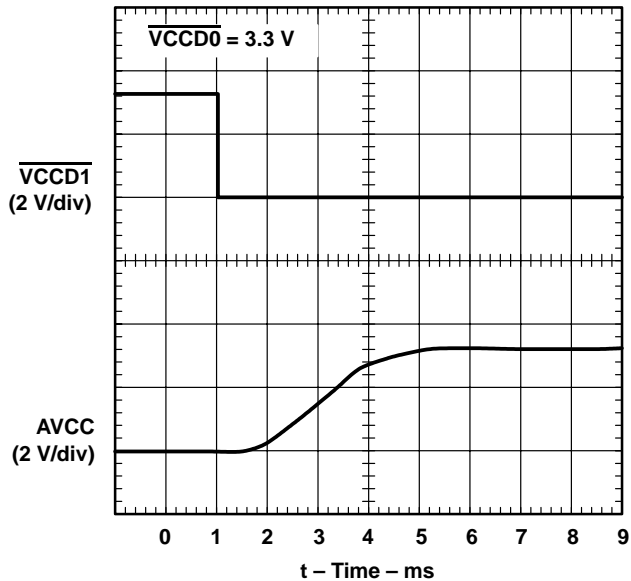

**Figure 2. AVCC Propagation Delay and Rise Time With 1- $\mu$ F Load, 3.3-V Switch**

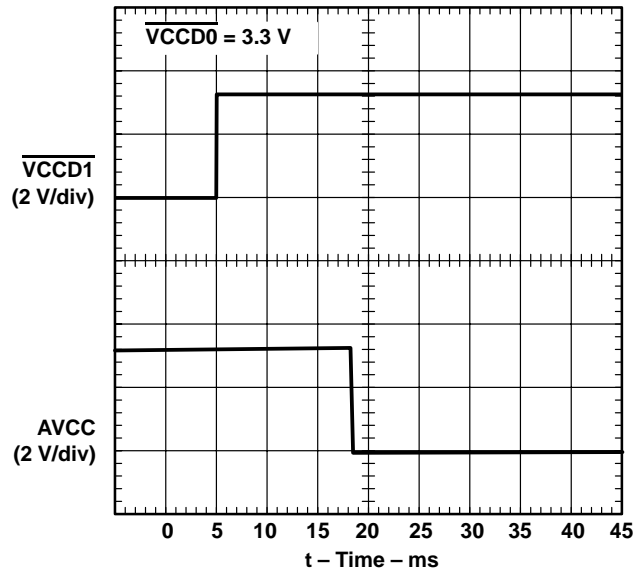

**Figure 3. AVCC Propagation Delay and Fall Time With 1- $\mu$ F Load, 3.3-V Switch**

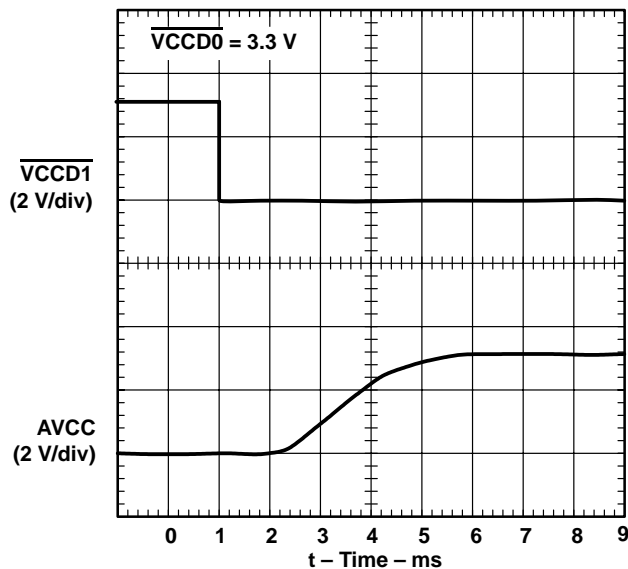

**Figure 4. AVCC Propagation Delay and Rise Time With 150- $\mu$ F Load, 3.3-V Switch**

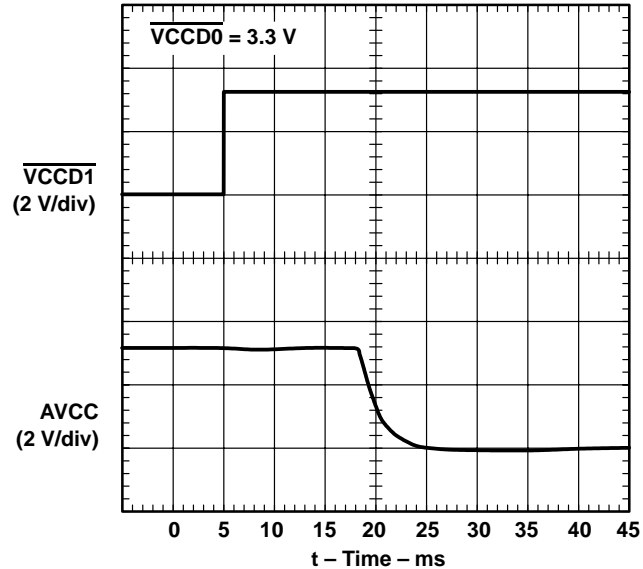

**Figure 5. AVCC Propagation Delay and Fall Time With 150- $\mu$ F Load, 3.3-V Switch**



**PARAMETER MEASUREMENT INFORMATION**

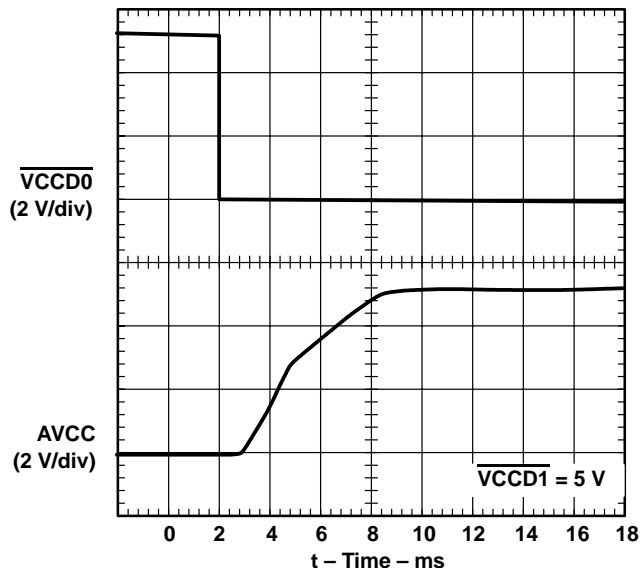

**Figure 6. AVCC Propagation Delay and Rise Time With 1- $\mu\text{F}$  Load, 5-V Switch**

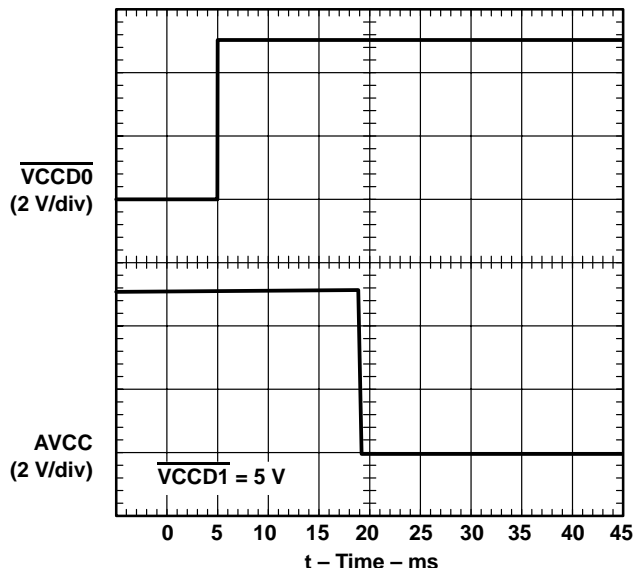

**Figure 7. AVCC Propagation Delay and Fall Time With 1- $\mu\text{F}$  Load, 5-V Switch**

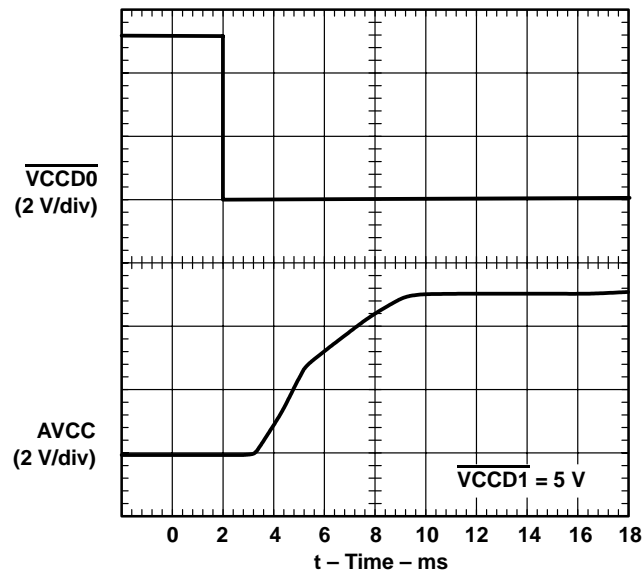

**Figure 8. AVCC Propagation Delay and Rise Time With 150- $\mu\text{F}$  Load, 5-V Switch**

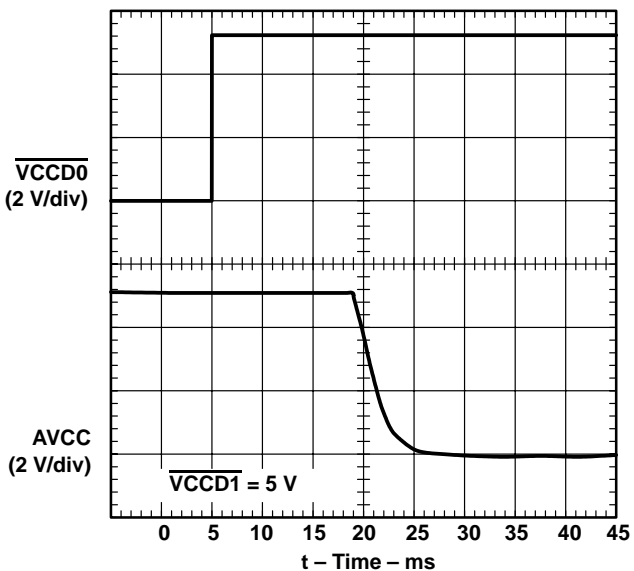
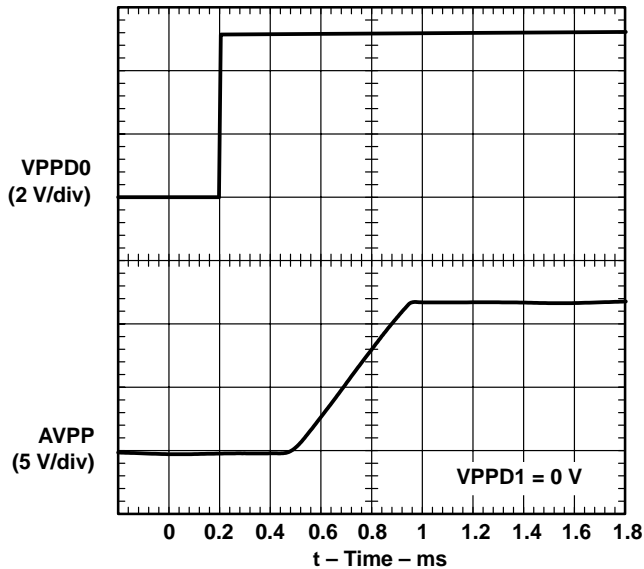

**Figure 9. AVCC Propagation Delay and Fall Time With 150- $\mu\text{F}$  Load, 5-V Switch**

**TPS2211**  
**SINGLE-SLOT PC CARD POWER INTERFACE SWITCH**  
**FOR PARALLEL PCMCIA CONTROLLERS**

SLVS156E – JULY 1997 – REVISED JANUARY 2001

**PARAMETER MEASUREMENT INFORMATION**



**Figure 10. AVPP Propagation Delay and Rise Time With 1- $\mu$ F Load, 12-V Switch**

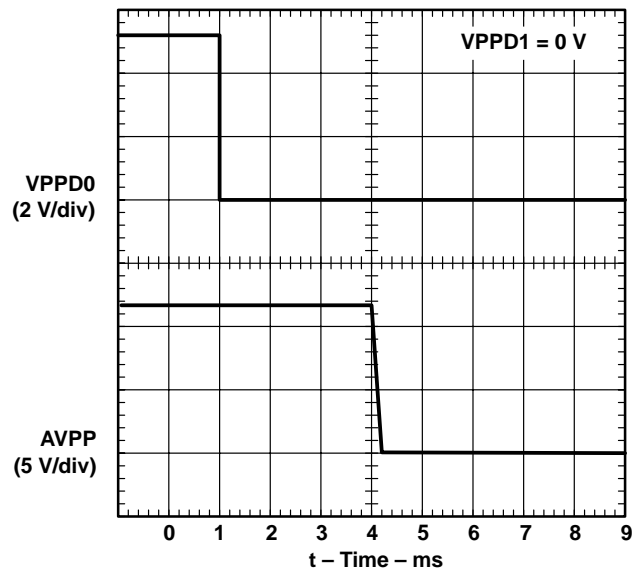

**Figure 11. AVPP Propagation Delay and Fall Time With 1- $\mu$ F Load, 12-V Switch**

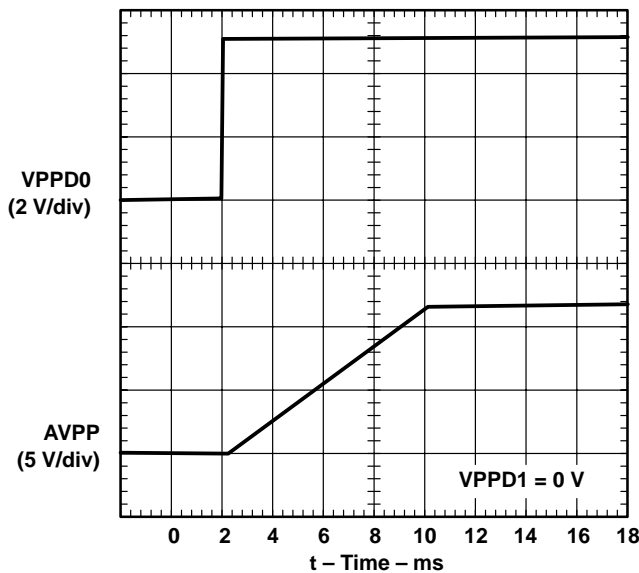

**Figure 12. AVPP Propagation Delay and Rise Time With 150- $\mu$ F Load, 12-V Switch**

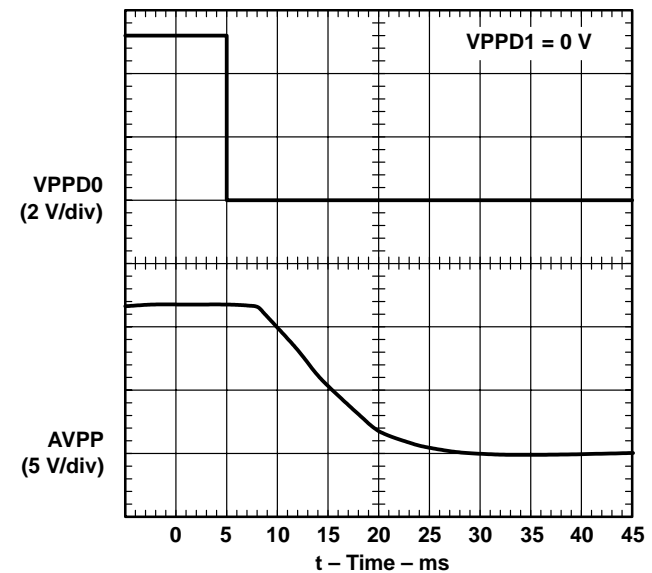

**Figure 13. AVPP Propagation Delay and Fall Time With 150- $\mu$ F Load, 12-V Switch**



**TPS2211**  
**SINGLE-SLOT PC CARD POWER INTERFACE SWITCH**  
**FOR PARALLEL PCMCIA CONTROLLERS**

SLVS156E – JULY 1997 – REVISED JANUARY 2001

**TYPICAL CHARACTERISTICS**

**Table of Graphs**

			<b>FIGURE</b>
$I_{CC}(5V)$	Supply current	vs Junction temperature	14
$I_{CC}(3.3V)$	Supply current	vs Junction temperature	15
$r_{DS(on)}$	Static drain-source on-state resistance, 5-V VCC switch	vs Junction temperature	16
$r_{DS(on)}$	Static drain-source on-state resistance, 3.3-V VCC switch	vs Junction temperature	17
$r_{DS(on)}$	Static drain-source on-state resistance, 12-V VPP switch	vs Junction temperature	18
$V_O(AVCC)$	Output voltage, 5-V VCC switch	vs Output current	19
$V_O(AVCC)$	Output voltage, 3.3-V VCC switch	vs Output current	20
$V_O(AVPP)$	Output voltage, 12-V VPP switch	vs Output current	21
$I_{OS}(AVCC)$	Short-circuit current, 5-V VCC switch	vs Junction temperature	22
$I_{OS}(AVCC)$	Short-circuit current, 3.3-V VCC switch	vs Junction temperature	23
$I_{OS}(AVPP)$	Short-circuit current, 12-V VPP switch	vs Junction temperature	24

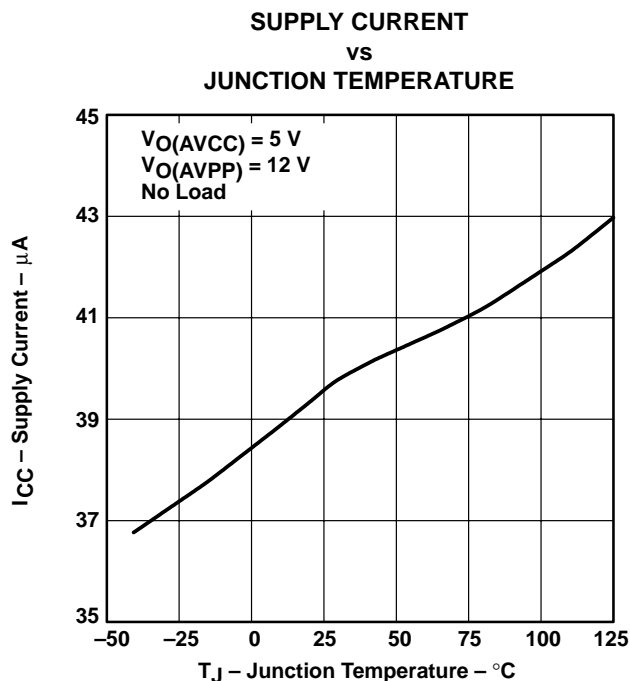

**Figure 14**

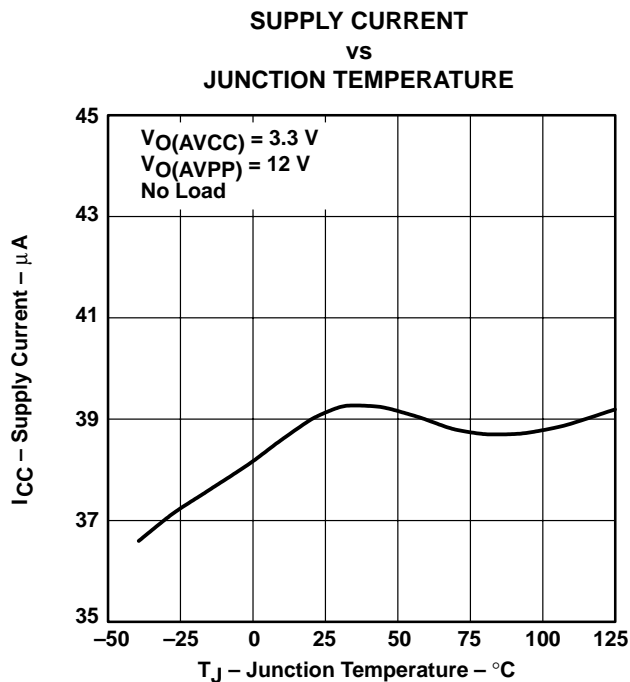

**Figure 15**

**TPS2211**  
**SINGLE-SLOT PC CARD POWER INTERFACE SWITCH**  
**FOR PARALLEL PCMCIA CONTROLLERS**

SLVS156E – JULY 1997 – REVISED JANUARY 2001

**TYPICAL CHARACTERISTICS**

**5-V VCC SWITCH**  
**STATIC DRAIN-SOURCE ON-STATE RESISTANCE**  
**vs**  
**JUNCTION TEMPERATURE**

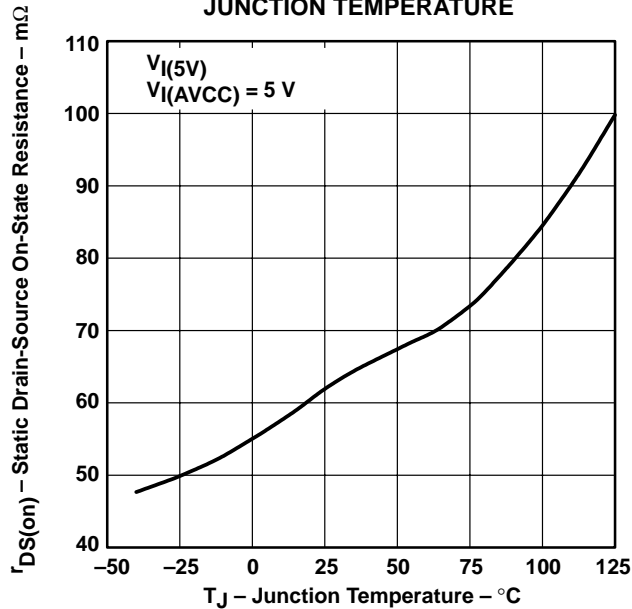

**Figure 16**

**3.3-V VCC SWITCH**  
**STATIC DRAIN-SOURCE ON-STATE RESISTANCE**  
**vs**  
**JUNCTION TEMPERATURE**

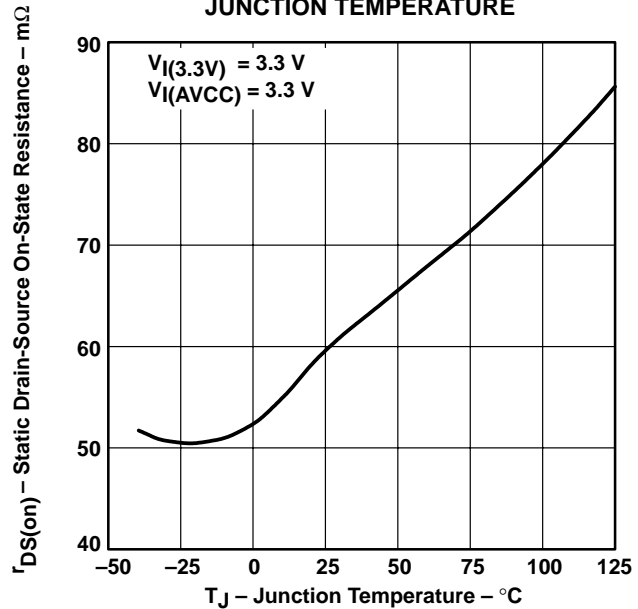

**Figure 17**

**12-V VPP SWITCH**  
**STATIC DRAIN-SOURCE ON-STATE RESISTANCE**  
**vs**  
**JUNCTION TEMPERATURE**

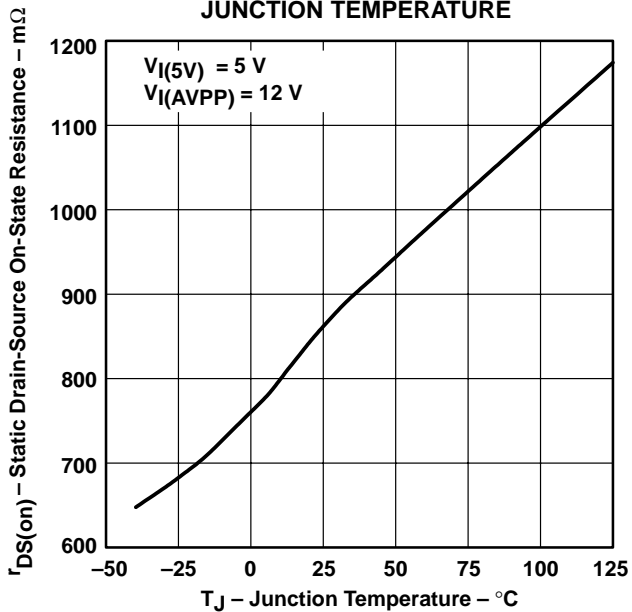

**Figure 18**

**5-V VCC SWITCH**  
**OUTPUT VOLTAGE**  
**vs**  
**OUTPUT CURRENT**

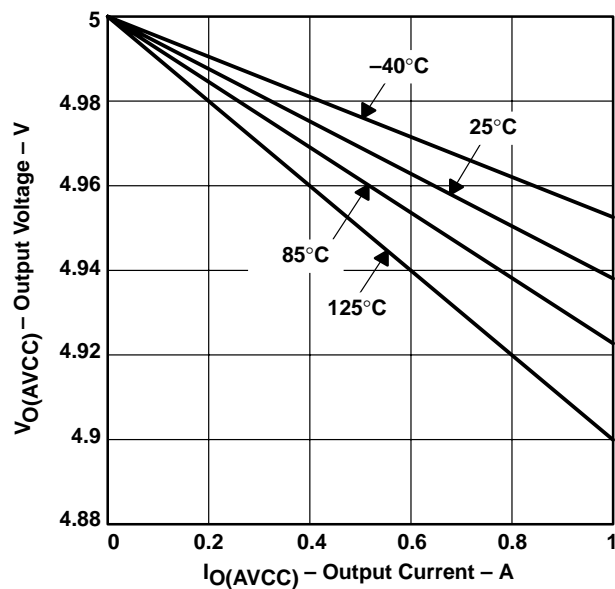

**Figure 19**



**TYPICAL CHARACTERISTICS**

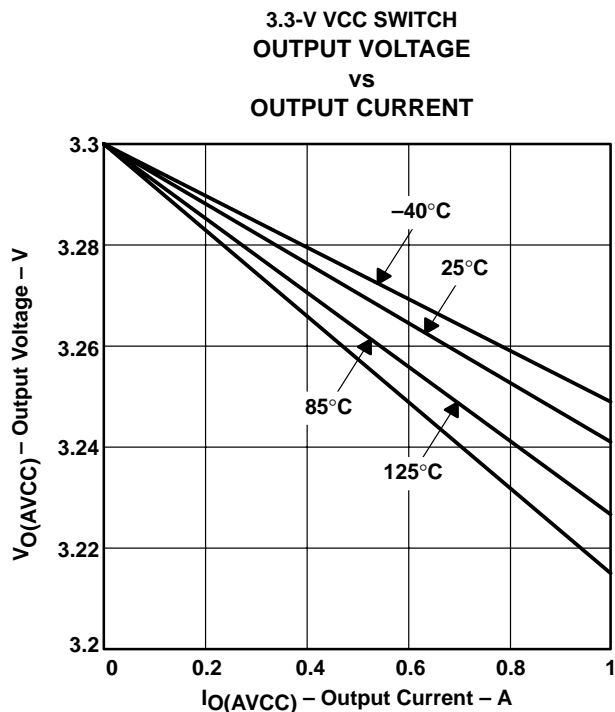

**Figure 20**

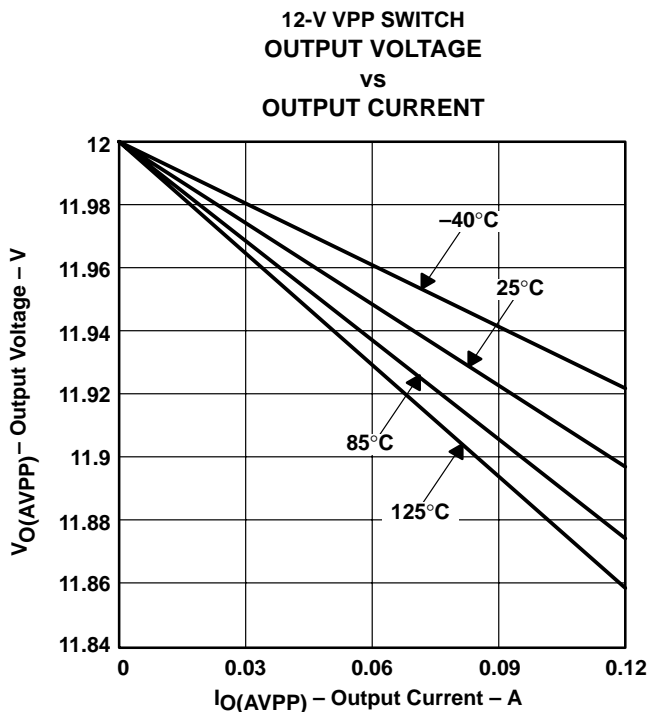

**Figure 21**

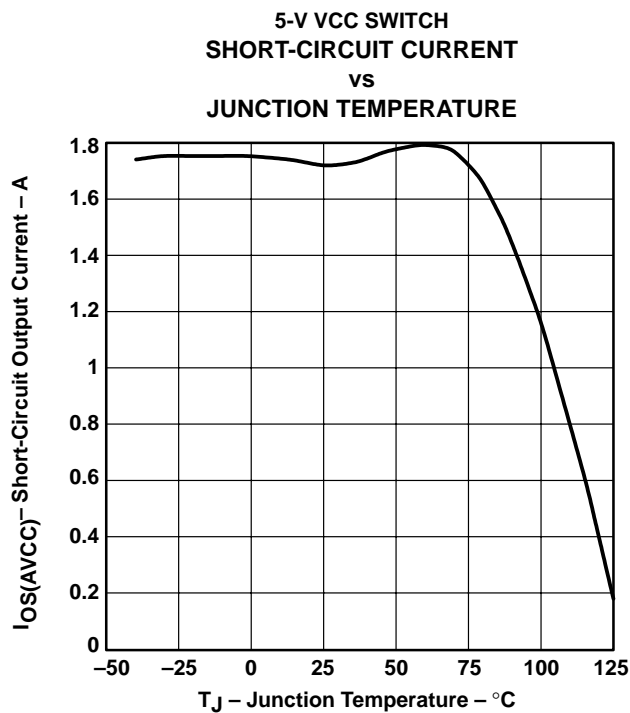

**Figure 22**

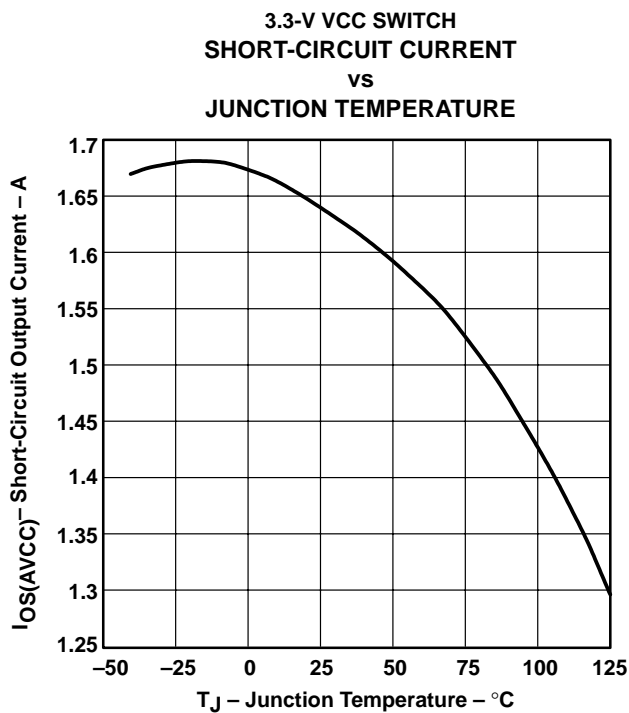

**Figure 23**

# TPS2211 SINGLE-SLOT PC CARD POWER INTERFACE SWITCH FOR PARALLEL PCMCIA CONTROLLERS

SLVS156E – JULY 1997 – REVISED JANUARY 2001

## TYPICAL CHARACTERISTICS

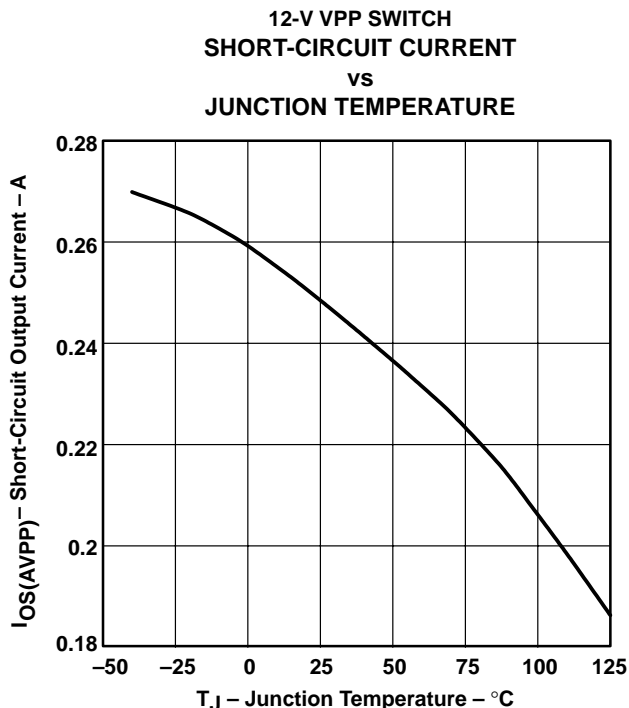

Figure 24

## APPLICATION INFORMATION

### overview

PC Cards were initially introduced as a means to add EEPROM (flash memory) to portable computers with limited onboard memory. The idea of add-in cards quickly took hold; modems, wireless LANs, GPS systems, multimedia, and hard-disk versions were soon available. As the number of PC Card applications grew, the engineering community quickly recognized the need for a standard to ensure compatibility across platforms. To this end, the PCMCIA (Personal Computer Memory Card International Association) was established, comprised of members from leading computer, software, PC Card, and semiconductor manufacturers. One key goal was to realize the *plug-and-play* concept, i.e. cards and hosts from different vendors should be compatible.

### PC Card power specification

System compatibility also means power compatibility. The most current set of specifications (PC Card Standard) set forth by the PCMCIA committee states that power is to be transferred between the host and the card through eight of the 68 terminals of the PC Card connectors. This power interface consists of two  $V_{CC}$ , two  $V_{pp}$ , and four ground terminals. Multiple  $V_{CC}$  and ground terminals minimize connector-terminal and line resistance. The two  $V_{pp}$  terminals were originally specified as separate signals but are commonly tied together in the host to form a single node to minimize voltage losses. Card primary power is supplied through the  $V_{CC}$  terminals; flash-memory programming and erase voltage is supplied through the  $V_{pp}$  terminals.



POST OFFICE BOX 655303 • DALLAS, TEXAS 75265

## APPLICATION INFORMATION

### designing for voltage regulation

The current PCMCIA specification for output voltage regulation of the 5-V output is 5% (250 mV). In a typical PC power-system design, the power supply will have an output voltage regulation ( $V_{PS(\text{reg})}$ ) of 2% (100 mV). Also, a voltage drop from the power supply to the PC Card will result from resistive losses ( $V_{PCB}$ ) in the PCB traces and the PCMCIA connector. A typical design would limit the total of these resistive losses to less than 1% (50 mV) of the output voltage. Therefore, the allowable voltage drop ( $V_{DS}$ ) for the TPS2211 is the PCMCIA voltage regulation less the power supply regulation and less the PCB and connector resistive drops:

$$V_{DS} = V_{O(\text{reg})} - V_{PS(\text{reg})} - V_{PCB}$$

Typically, this would leave 100 mV for the allowable voltage drop across the TPS2211. The voltage drop is the output current multiplied by the switch resistance of the TPS2211. Therefore, the maximum output current that can be delivered to the PC Card in regulation is the allowable voltage drop across the TPS2211 divided by the output switch resistance.

$$I_{O\text{max}} = \frac{V_{DS}}{r_{DS(\text{on})}}$$

The AVCC outputs deliver 1 A continuous at 5 V and 3.3 V within regulation over the operating temperature range. Using the same equations, the PCMCIA specification for output voltage regulation of the 3.3-V output is 300 mV. Using the voltage drop percentages for power supply regulation (2%) and PCB resistive loss (1%), the allowable voltage drop for the 3.3-V switch is 200 mV. The 12-V outputs (AVPP) of the TPS2211 can deliver 150 mA continuously.

### overcurrent and overtemperature protection

PC Cards are inherently subject to damage from mishandling. Host systems require protection against short-circuited cards that could lead to power supply or PCB trace damage. Even systems sufficiently robust to withstand a short circuit would still undergo rapid battery discharge into the damaged PC Card, resulting in a sudden loss of system power. Most hosts include fuses for protection. The reliability of fused systems is poor and requires troubleshooting and repair, usually by the manufacturer, when fuses are blown.

The TPS2211 uses sense FETs to check for overcurrent conditions in each of the AVCC and AVPP outputs. Unlike sense resistors or polyfuses, these FETs do not add to the series resistance of the switch; therefore voltage and power losses are reduced. Overcurrent sensing is applied to each output separately. When an overcurrent condition is detected, only the power output affected is limited; all other power outputs continue to function normally. The  $\overline{OC}$  indicator, normally a logic high, is a logic low when an overcurrent condition is detected providing for initiation of system diagnostics and/or sending a warning message to the user.

During power up, the TPS2211 controls the rise time of the AVCC and AVPP outputs and limits the current into a faulty card or connector. If a short circuit is applied after power is established (e.g., hot insertion of a bad card), current is initially limited only by the impedance between the short and the power supply. In extreme cases, as much as 10 A to 15 A may flow into the short before the current limiting of the TPS2211 engages. If the AVCC or AVPP outputs are driven below ground, the TPS2211 may latch nondestructively in an off state. Cycling power will reestablish normal operation.

Overcurrent limiting for the AVCC outputs is designed to activate if powered up into a short in the range of 1 A to 2.2 A, typically at about 1.6 A. The AVPP outputs limit from 120 mA to 400 mA, typically around 280 mA. The protection circuitry acts by linearly limiting the current passing through the switch rather than initiating a full shutdown of the supply. Shutdown occurs only during thermal limiting.

Thermal limiting prevents destruction of the IC from overheating if the package power dissipation ratings are exceeded. Thermal limiting disables power output until the device has cooled.

# TPS2211

## SINGLE-SLOT PC CARD POWER INTERFACE SWITCH FOR PARALLEL PCMCIA CONTROLLERS

SLVS156E – JULY 1997 – REVISED JANUARY 2001

---

### APPLICATION INFORMATION

#### 12-V supply not required

Most PC Card switches use the externally supplied 12 V to power gate drive and other chip functions, which require that power be present at all times. The TPS2211 offers considerable power savings by using an internal charge pump to generate the required higher voltages from the 5-V input. Therefore, the external 12-V supply can be disabled except when needed for flash-memory functions, thereby extending battery lifetime. Do not ground the 12-V switch inputs when the 12-V input is not used. Additional power savings are realized by the TPS2211 during a software shutdown in which quiescent current drops to a maximum of 1  $\mu$ A.

#### 3.3-V low-voltage mode

The TPS2211 will operate in a 3.3-V low-voltage mode when 3.3 V is the only available input voltage ( $V_{I(5V)} = 0$ ). This allows host and PC Cards to be operated in low-power 3.3-volts-only modes such as sleep or pager modes. Note that in these operation modes, the TPS2211 will derive its bias current from the 3.3-V input pin and only 3.3 V can be delivered to the PC Card.

#### voltage transitioning requirement

PC Cards are migrating from 5 V to 3.3 V to minimize power consumption, optimize board space, and increase logic speeds. The TPS2211 meets all combinations of power delivery as currently defined in the PCMCIA standard. The latest protocol accommodates mixed 3.3-V/5-V systems by first powering the card with 5 V, then polling it to determine its 3.3-V compatibility. The PCMCIA specification requires that the capacitors on 3.3-V compatible cards be discharged to below 0.8 V before applying 3.3-V power. This functions as a power reset and ensures that sensitive 3.3-V circuitry is not subjected to any residual 5-V charge. The TPS2211 offers a selectable  $V_{CC}$  and  $V_{pp}$  ground state, in accordance with PCMCIA 3.3-V/5-V switching specifications.

#### output ground switches

PC Card specification requires that  $V_{CC}$  be discharged within 100 ms. PC Card resistance can not be relied on to provide a discharge path for voltages stored on PC Card capacitance because of possible high-impedance isolation by power-management schemes.

#### power-supply considerations

The TPS2211 has multiple pins for each of its 3.3-V and 5-V power inputs and for the switched AVCC outputs. Any individual pin can conduct the rated input or output current. Unless all pins are connected in parallel, the series resistance is significantly higher than that specified, resulting in increased voltage drops and lost power. It is recommended that all input and output power pins be paralleled for optimum operation.

To increase the noise immunity of the TPS2211, the power supply inputs should be bypassed with a 1- $\mu$ F electrolytic or tantalum capacitor paralleled by a 0.047- $\mu$ F to 0.1- $\mu$ F ceramic capacitor. It is strongly recommended that the switched outputs be bypassed with a 0.1- $\mu$ F, or larger, ceramic capacitor; doing so improves the immunity of the TPS2211 to electrostatic discharge (ESD). Care should be taken to minimize the inductance of PCB traces between the TPS2211 and the load. High switching currents can produce large negative voltage transients, which forward biases substrate diodes, resulting in unpredictable performance. Similarly, no pin should be taken below  $-0.3$  V.



POST OFFICE BOX 655303 • DALLAS, TEXAS 75265



## APPLICATION INFORMATION

### calculating junction temperature

The switch resistance,  $r_{DS(on)}$ , is dependent on the junction temperature,  $T_J$ , of the die and the current through the switch. To calculate  $T_J$ , first find  $r_{DS(on)}$  from Figures 16 through 18 using an initial temperature estimate about 50°C above ambient. Then calculate the power dissipation for each switch, using the formula:

$$P_D = r_{DS(on)} \times I^2$$

Next, sum the power dissipation and calculate the junction temperature:

$$T_J = \left( \sum P_D \times R_{\theta JA} \right) + T_A, \quad R_{\theta JA} = 108^\circ\text{C/W}$$

Compare the calculated junction temperature with the initial temperature estimate. If the temperatures are not within a few degrees of each other, recalculate using the calculated temperature as the initial estimate.

### ESD protection

All TPS2211 inputs and outputs incorporate ESD-protection circuitry designed to withstand a 2-kV human-body-model discharge as defined in MIL-STD-883C, Method 3015. The AVCC and AVPP outputs can be exposed to potentially higher discharges from the external environment through the PC Card connector. Bypassing the outputs with 0.1- $\mu\text{F}$  capacitors protects the devices from discharges up to 10 kV.

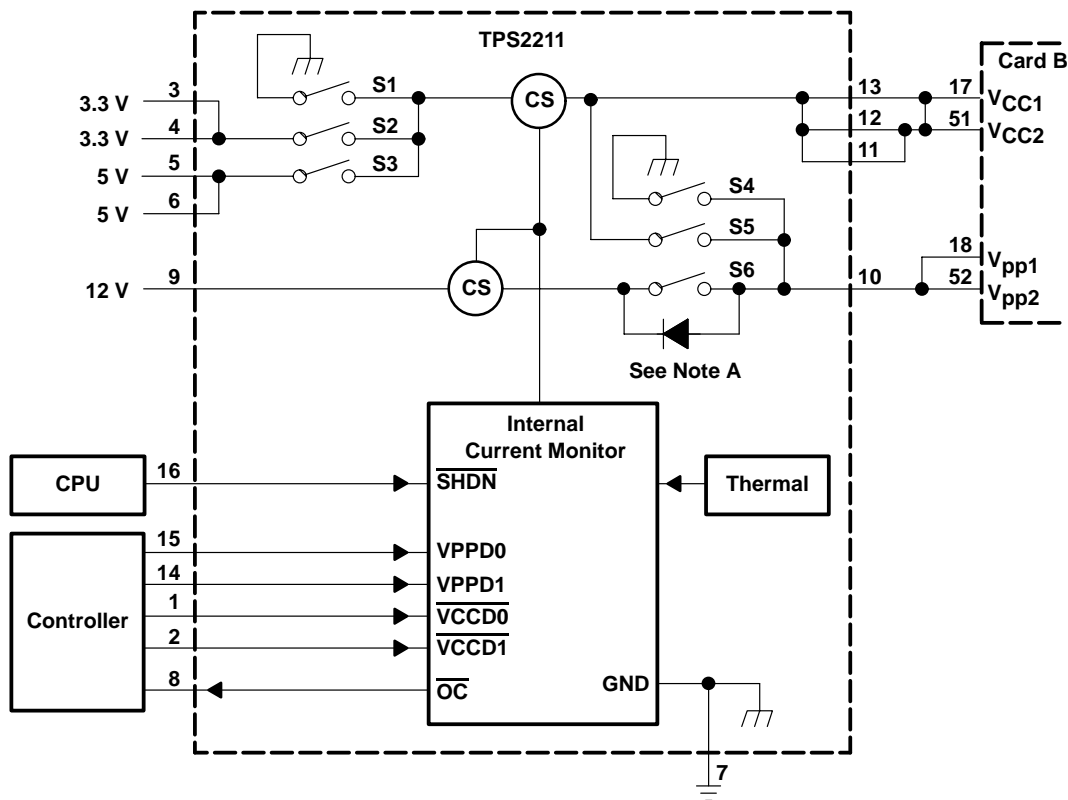

NOTE A: MOSFET switch S6 has a back-gate diode from the source to the drain. Unused switch inputs should never be grounded.

**Figure 25. Internal Switching Matrix, TPS2211 Control Logic**

**TPS2211**  
**SINGLE-SLOT PC CARD POWER INTERFACE SWITCH**  
**FOR PARALLEL PCMCIA CONTROLLERS**

SLVS156E – JULY 1997 – REVISED JANUARY 2001

**APPLICATION INFORMATION**

**TPS2211 control logic**

**AVPP**

CONTROL SIGNALS			INTERNAL SWITCH SETTINGS			OUTPUT
$\overline{\text{SHDN}}$	VPPD0	VPPD1	S4	S5	S6	AVPP
1	0	0	CLOSED	OPEN	OPEN	0 V
1	0	1	OPEN	CLOSED	OPEN	AVCC†
1	1	0	OPEN	OPEN	CLOSED	VPP (12 V)
1	1	1	OPEN	OPEN	OPEN	Hi-Z
0	X	X	OPEN	OPEN	OPEN	Hi-Z

† Output depends on AVCC

**AVCC**

CONTROL SIGNALS			INTERNAL SWITCH SETTINGS			OUTPUT
$\overline{\text{SHDN}}$	$\overline{\text{VCCD1}}$	$\overline{\text{VCCD0}}$	S1	S2	S3	AVCC
1	0	0	CLOSED	OPEN	OPEN	0 V
1	0	1	OPEN	CLOSED	OPEN	3.3 V
1	1	0	OPEN	OPEN	CLOSED	5 V
1	1	1	CLOSED	OPEN	OPEN	0 V
0	X	X	OPEN	OPEN	OPEN	Hi-Z

**12-V flash memory supply**

The TPS6734 is a fixed 12-V output boost converter capable of delivering 120 mA from inputs as low as 2.7 V. The device is pin-for-pin compatible with the MAX734 regulator and offers the following advantages: lower supply current, wider operating input-voltage range, and higher output currents. As shown in Figure 1, the only external components required are: an inductor, a Schottky rectifier, an output filter capacitor, an input filter capacitor, and a small capacitor for loop compensation. The entire converter occupies less than 0.7 in<sup>2</sup> of PCB space when implemented with surface-mount components. An enable input is provided to shut the converter down and reduce the supply current to 3  $\mu$ A when 12 V is not needed.

The TPS6734 is a 170-kHz current-mode PWM (pulse-width modulation) controller with an n-channel MOSFET power switch. Gate drive for the switch is derived from the 12-V output after start-up to minimize the die area needed to realize the 0.7- $\Omega$  MOSFET and improve efficiency at input voltages below 5 V. Soft start is accomplished with the addition of one small capacitor. A 1.22-V reference (pin 2) is brought out for external use. For additional information, see the TPS6734 data sheet (SLVS127).



**TPS2211**  
**SINGLE-SLOT PC CARD POWER INTERFACE SWITCH**  
**FOR PARALLEL PCMCIA CONTROLLERS**

SLVS156E – JULY 1997 – REVISED JANUARY 2001

**APPLICATION INFORMATION**

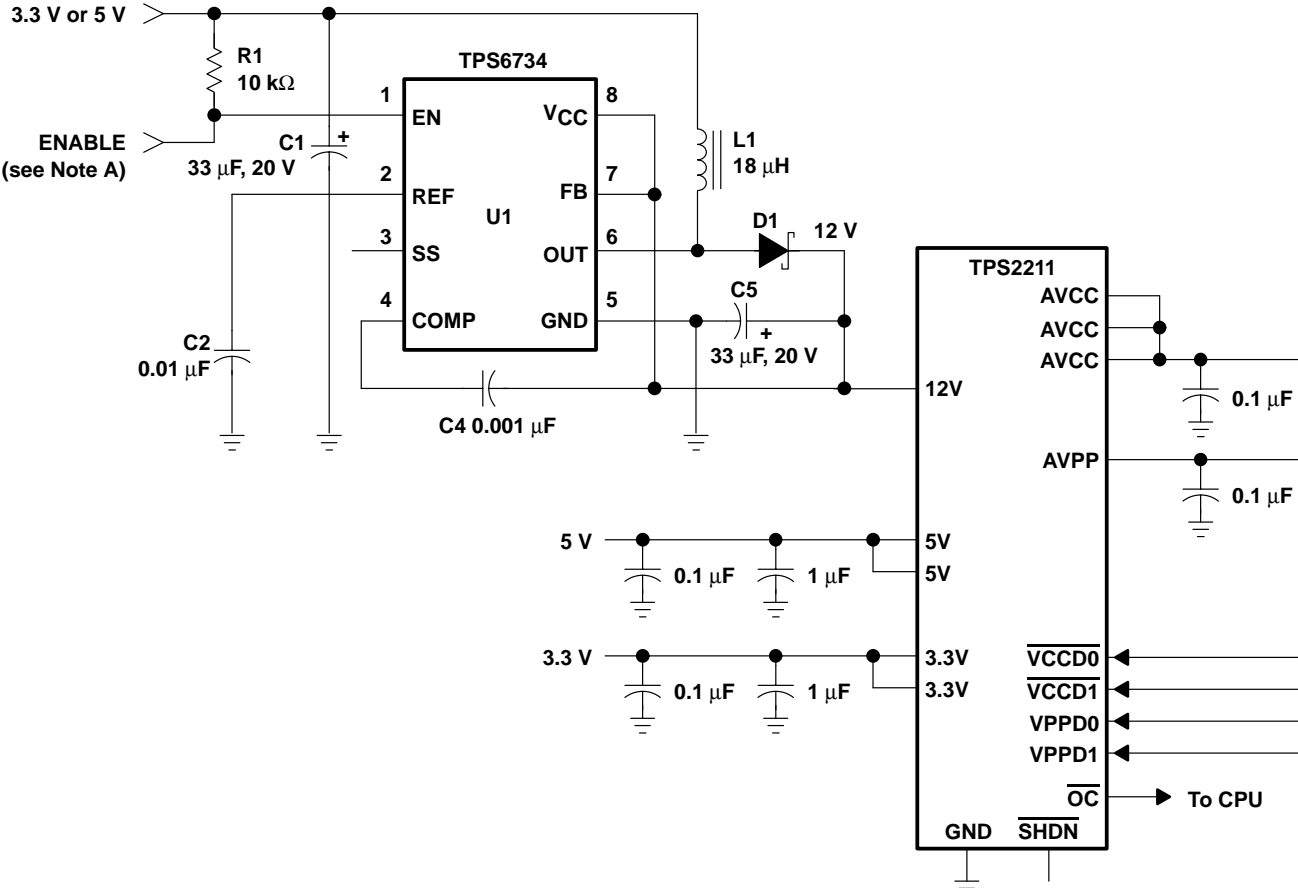

NOTE A: The enable terminal can be tied to a general-purpose I/O terminal on the PCMCIA controller or tied high.

**Figure 26. TPS2211 With TPS6734 12-V, 120-mA Supply**



**PACKAGING INFORMATION**

Orderable Device	Status <sup>(1)</sup>	Package Type	Package Drawing	Pins	Package Qty	Eco Plan <sup>(2)</sup>	Lead/Ball Finish	MSL Peak Temp <sup>(3)</sup>
TPS2211IDB	ACTIVE	SSOP	DB	16	80	Green (RoHS & no Sb/Br)	CU NIPDAU	Level-1-260C-UNLIM
TPS2211IDBG4	ACTIVE	SSOP	DB	16	80	Green (RoHS & no Sb/Br)	CU NIPDAU	Level-1-260C-UNLIM
TPS2211IDBLE	OBSOLETE	SSOP	DB	16		TBD	Call TI	Call TI
TPS2211IDBR	ACTIVE	SSOP	DB	16	2000	Green (RoHS & no Sb/Br)	CU NIPDAU	Level-1-260C-UNLIM
TPS2211IDBRG4	ACTIVE	SSOP	DB	16	2000	Green (RoHS & no Sb/Br)	CU NIPDAU	Level-1-260C-UNLIM

<sup>(1)</sup> The marketing status values are defined as follows:

**ACTIVE:** Product device recommended for new designs.

**LIFEBUY:** TI has announced that the device will be discontinued, and a lifetime-buy period is in effect.

**NRND:** Not recommended for new designs. Device is in production to support existing customers, but TI does not recommend using this part in a new design.

**PREVIEW:** Device has been announced but is not in production. Samples may or may not be available.

**OBSOLETE:** TI has discontinued the production of the device.

<sup>(2)</sup> Eco Plan - The planned eco-friendly classification: Pb-Free (RoHS), Pb-Free (RoHS Exempt), or Green (RoHS & no Sb/Br) - please check <http://www.ti.com/productcontent> for the latest availability information and additional product content details.

**TBD:** The Pb-Free/Green conversion plan has not been defined.

**Pb-Free (RoHS):** TI's terms "Lead-Free" or "Pb-Free" mean semiconductor products that are compatible with the current RoHS requirements for all 6 substances, including the requirement that lead not exceed 0.1% by weight in homogeneous materials. Where designed to be soldered at high temperatures, TI Pb-Free products are suitable for use in specified lead-free processes.

**Pb-Free (RoHS Exempt):** This component has a RoHS exemption for either 1) lead-based flip-chip solder bumps used between the die and package, or 2) lead-based die adhesive used between the die and leadframe. The component is otherwise considered Pb-Free (RoHS compatible) as defined above.

**Green (RoHS & no Sb/Br):** TI defines "Green" to mean Pb-Free (RoHS compatible), and free of Bromine (Br) and Antimony (Sb) based flame retardants (Br or Sb do not exceed 0.1% by weight in homogeneous material)

<sup>(3)</sup> MSL, Peak Temp. -- The Moisture Sensitivity Level rating according to the JEDEC industry standard classifications, and peak solder temperature.

**Important Information and Disclaimer:**The information provided on this page represents TI's knowledge and belief as of the date that it is provided. TI bases its knowledge and belief on information provided by third parties, and makes no representation or warranty as to the accuracy of such information. Efforts are underway to better integrate information from third parties. TI has taken and continues to take reasonable steps to provide representative and accurate information but may not have conducted destructive testing or chemical analysis on incoming materials and chemicals. TI and TI suppliers consider certain information to be proprietary, and thus CAS numbers and other limited information may not be available for release.

In no event shall TI's liability arising out of such information exceed the total purchase price of the TI part(s) at issue in this document sold by TI to Customer on an annual basis.

**TAPE AND REEL INFORMATION**

**REEL DIMENSIONS**



**TAPE DIMENSIONS**



A0	Dimension designed to accommodate the component width
B0	Dimension designed to accommodate the component length
K0	Dimension designed to accommodate the component thickness
W	Overall width of the carrier tape
P1	Pitch between successive cavity centers

**TAPE AND REEL INFORMATION**

\*All dimensions are nominal

Device	Package Type	Package Drawing	Pins	SPQ	Reel Diameter (mm)	Reel Width W1 (mm)	A0 (mm)	B0 (mm)	K0 (mm)	P1 (mm)	W (mm)	Pin1 Quadrant
TPS2211IDBR	SSOP	DB	16	2000	330.0	16.4	8.2	6.6	2.5	12.0	16.0	Q1

TAPE AND REEL BOX DIMENSIONS



\*All dimensions are nominal

Device	Package Type	Package Drawing	Pins	SPQ	Length (mm)	Width (mm)	Height (mm)
TPS2211IDBR	SSOP	DB	16	2000	367.0	367.0	38.0

## IMPORTANT NOTICE

Texas Instruments Incorporated and its subsidiaries (TI) reserve the right to make corrections, enhancements, improvements and other changes to its semiconductor products and services per JESD46C and to discontinue any product or service per JESD48B. Buyers should obtain the latest relevant information before placing orders and should verify that such information is current and complete. All semiconductor products (also referred to herein as "components") are sold subject to TI's terms and conditions of sale supplied at the time of order acknowledgment.

TI warrants performance of its components to the specifications applicable at the time of sale, in accordance with the warranty in TI's terms and conditions of sale of semiconductor products. Testing and other quality control techniques are used to the extent TI deems necessary to support this warranty. Except where mandated by applicable law, testing of all parameters of each component is not necessarily performed.

TI assumes no liability for applications assistance or the design of Buyers' products. Buyers are responsible for their products and applications using TI components. To minimize the risks associated with Buyers' products and applications, Buyers should provide adequate design and operating safeguards.

TI does not warrant or represent that any license, either express or implied, is granted under any patent right, copyright, mask work right, or other intellectual property right relating to any combination, machine, or process in which TI components or services are used. Information published by TI regarding third-party products or services does not constitute a license to use such products or services or a warranty or endorsement thereof. Use of such information may require a license from a third party under the patents or other intellectual property of the third party, or a license from TI under the patents or other intellectual property of TI.

Reproduction of significant portions of TI information in TI data books or data sheets is permissible only if reproduction is without alteration and is accompanied by all associated warranties, conditions, limitations, and notices. TI is not responsible or liable for such altered documentation. Information of third parties may be subject to additional restrictions.

Resale of TI components or services with statements different from or beyond the parameters stated by TI for that component or service voids all express and any implied warranties for the associated TI component or service and is an unfair and deceptive business practice. TI is not responsible or liable for any such statements.

Buyer acknowledges and agrees that it is solely responsible for compliance with all legal, regulatory and safety-related requirements concerning its products, and any use of TI components in its applications, notwithstanding any applications-related information or support that may be provided by TI. Buyer represents and agrees that it has all the necessary expertise to create and implement safeguards which anticipate dangerous consequences of failures, monitor failures and their consequences, lessen the likelihood of failures that might cause harm and take appropriate remedial actions. Buyer will fully indemnify TI and its representatives against any damages arising out of the use of any TI components in safety-critical applications.

In some cases, TI components may be promoted specifically to facilitate safety-related applications. With such components, TI's goal is to help enable customers to design and create their own end-product solutions that meet applicable functional safety standards and requirements. Nonetheless, such components are subject to these terms.

No TI components are authorized for use in FDA Class III (or similar life-critical medical equipment) unless authorized officers of the parties have executed a special agreement specifically governing such use.

Only those TI components which TI has specifically designated as military grade or "enhanced plastic" are designed and intended for use in military/aerospace applications or environments. Buyer acknowledges and agrees that any military or aerospace use of TI components which have **not** been so designated is solely at the Buyer's risk, and that Buyer is solely responsible for compliance with all legal and regulatory requirements in connection with such use.

TI has specifically designated certain components which meet ISO/TS16949 requirements, mainly for automotive use. Components which have not been so designated are neither designed nor intended for automotive use; and TI will not be responsible for any failure of such components to meet such requirements.

### Products

Audio	<a href="http://www.ti.com/audio">www.ti.com/audio</a>
Amplifiers	<a href="http://amplifier.ti.com">amplifier.ti.com</a>
Data Converters	<a href="http://dataconverter.ti.com">dataconverter.ti.com</a>
DLP® Products	<a href="http://www.dlp.com">www.dlp.com</a>
DSP	<a href="http://dsp.ti.com">dsp.ti.com</a>
Clocks and Timers	<a href="http://www.ti.com/clocks">www.ti.com/clocks</a>
Interface	<a href="http://interface.ti.com">interface.ti.com</a>
Logic	<a href="http://logic.ti.com">logic.ti.com</a>
Power Mgmt	<a href="http://power.ti.com">power.ti.com</a>
Microcontrollers	<a href="http://microcontroller.ti.com">microcontroller.ti.com</a>
RFID	<a href="http://www.ti-rfid.com">www.ti-rfid.com</a>
OMAP Mobile Processors	<a href="http://www.ti.com/omap">www.ti.com/omap</a>
Wireless Connectivity	<a href="http://www.ti.com/wirelessconnectivity">www.ti.com/wirelessconnectivity</a>

### Applications

Automotive and Transportation	<a href="http://www.ti.com/automotive">www.ti.com/automotive</a>
Communications and Telecom	<a href="http://www.ti.com/communications">www.ti.com/communications</a>
Computers and Peripherals	<a href="http://www.ti.com/computers">www.ti.com/computers</a>
Consumer Electronics	<a href="http://www.ti.com/consumer-apps">www.ti.com/consumer-apps</a>
Energy and Lighting	<a href="http://www.ti.com/energy">www.ti.com/energy</a>
Industrial	<a href="http://www.ti.com/industrial">www.ti.com/industrial</a>
Medical	<a href="http://www.ti.com/medical">www.ti.com/medical</a>
Security	<a href="http://www.ti.com/security">www.ti.com/security</a>
Space, Avionics and Defense	<a href="http://www.ti.com/space-avionics-defense">www.ti.com/space-avionics-defense</a>
Video and Imaging	<a href="http://www.ti.com/video">www.ti.com/video</a>

**TI E2E Community** [e2e.ti.com](http://e2e.ti.com)



## Стандарт Электрон Связь

Мы молодая и активно развивающаяся компания в области поставок электронных компонентов. Мы поставляем электронные компоненты отечественного и импортного производства напрямую от производителей и с крупнейших складов мира.

Благодаря сотрудничеству с мировыми поставщиками мы осуществляем комплексные и плановые поставки широчайшего спектра электронных компонентов.

Собственная эффективная логистика и склад в обеспечивает надежную поставку продукции в точно указанные сроки по всей России.

Мы осуществляем техническую поддержку нашим клиентам и предпродажную проверку качества продукции. На все поставляемые продукты мы предоставляем гарантию .

Осуществляем поставки продукции под контролем ВП МО РФ на предприятия военно-промышленного комплекса России , а также работаем в рамках 275 ФЗ с открытием отдельных счетов в уполномоченном банке. Система менеджмента качества компании соответствует требованиям ГОСТ ISO 9001.

Минимальные сроки поставки, гибкие цены, неограниченный ассортимент и индивидуальный подход к клиентам являются основой для выстраивания долгосрочного и эффективного сотрудничества с предприятиями радиоэлектронной промышленности, предприятиями ВПК и научно-исследовательскими институтами России.

С нами вы становитесь еще успешнее!

### Наши контакты:

**Телефон:** +7 812 627 14 35

**Электронная почта:** [sales@st-electron.ru](mailto:sales@st-electron.ru)

**Адрес:** 198099, Санкт-Петербург,  
Промышленная ул, дом № 19, литера Н,  
помещение 100-Н Офис 331