

**INSULATED GATE BIPOLAR TRANSISTOR WITH
ULTRAFAST SOFT RECOVERY DIODE**

**IRGP4066DPbF
IRGP4066D-EPbF**

Features

- Low $V_{CE(ON)}$ Trench IGBT Technology
- Low Switching Losses
- Maximum Junction Temperature 175 °C
- 5 μ S short circuit SOA
- Square RBSOA
- 100% of The Parts Tested for I_{LM}
- Positive $V_{CE(ON)}$ Temperature Coefficient
- Tight Parameter Distribution
- Lead Free Package

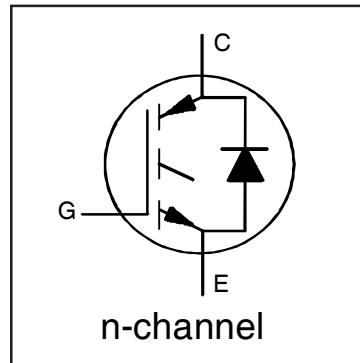

| |
|---|
| $V_{CES} = 600V$ |
| $I_{C(Nominal)} = 75A$ |
| $t_{SC} \geq 5\mu s, T_{J(max)} = 175^{\circ}C$ |
| $V_{CE(on)} \text{ typ.} = 1.70V$ |

Benefits

- High Efficiency in a Wide Range of Applications
- Suitable for a Wide Range of Switching Frequencies due to Low $V_{CE(ON)}$ and Low Switching Losses
- Rugged Transient Performance for Increased Reliability
- Excellent Current Sharing in Parallel Operation

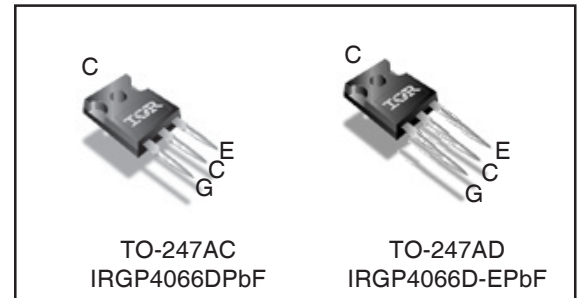

| | | |
|----------|-----------|----------|
| G | C | E |
| Gate | Collector | Emitter |

Absolute Maximum Ratings

| | Parameter | Max. | Units |
|----------------------------|---|-----------------------------------|-------------|
| V_{CES} | Collector-to-Emitter Voltage | 600 | V |
| $I_C @ T_C = 25^{\circ}C$ | Continuous Collector Current | 140 | A |
| $I_C @ T_C = 100^{\circ}C$ | Continuous Collector Current | 90 | |
| $I_{NOMINAL}$ | Nominal Current | 75 | |
| I_{CM} | Pulse Collector Current, $V_{GE} = 15V$ | 225 | |
| I_{LM} | Clamped Inductive Load Current, $V_{GE} = 20V$ ① | 300 | |
| $I_F @ T_C = 25^{\circ}C$ | Diode Continuous Forward Current | 140 | |
| $I_F @ T_C = 100^{\circ}C$ | Diode Continuous Forward Current | 90 | |
| I_{FM} | Diode Maximum Forward Current ② | 300 | |
| V_{GE} | Continuous Gate-to-Emitter Voltage | ± 20 | V |
| | Transient Gate-to-Emitter Voltage | ± 30 | |
| $P_D @ T_C = 25^{\circ}C$ | Maximum Power Dissipation | 454 | W |
| | $P_D @ T_C = 100^{\circ}C$ | Maximum Power Dissipation | |
| T_J T_{STG} | Operating Junction and Storage Temperature Range | -55 to +175 | $^{\circ}C$ |
| | Soldering Temperature, for 10 sec. | 300 (0.063 in. (1.6mm) from case) | |
| | Mounting Torque, 6-32 or M3 Screw | 10 lbf-in (1.1 N-m) | |

Thermal Resistance

| | Parameter | Min. | Typ. | Max. | Units |
|-------------------------|--|------|------|------|---------------|
| $R_{\theta JC}$ (IGBT) | Thermal Resistance Junction-to-Case-(each IGBT) ④ | — | — | 0.33 | $^{\circ}C/W$ |
| $R_{\theta JC}$ (Diode) | Thermal Resistance Junction-to-Case-(each Diode) ④ | — | — | 1.0 | |
| $R_{\theta CS}$ | Thermal Resistance, Case-to-Sink (flat, greased surface) | — | 0.24 | — | |
| $R_{\theta JA}$ | Thermal Resistance, Junction-to-Ambient (typical socket mount) | — | — | 40 | |

Electrical Characteristics @ T_J = 25°C (unless otherwise specified)

| | Parameter | Min. | Typ. | Max. | Units | Conditions |
|--|---|------|------|------|-------|---|
| V _{(BR)CES} | Collector-to-Emitter Breakdown Voltage | 600 | — | — | V | V _{GE} = 0V, I _C = 100μA ③ |
| ΔV _{(BR)CES} /ΔT _J | Temperature Coeff. of Breakdown Voltage | — | 0.30 | — | V/°C | V _{GE} = 0V, I _C = 2.0mA (25°C-175°C) |
| V _{CE(on)} | Collector-to-Emitter Saturation Voltage | — | 1.70 | 2.10 | V | I _C = 75A, V _{GE} = 15V, T _J = 25°C ② |
| | | — | 2.0 | — | | I _C = 75A, V _{GE} = 15V, T _J = 150°C ② |
| | | — | 2.1 | — | | I _C = 75A, V _{GE} = 15V, T _J = 175°C ② |
| V _{GE(th)} | Gate Threshold Voltage | 4.0 | — | 6.5 | V | V _{CE} = V _{GE} , I _C = 2.1mA |
| ΔV _{GE(th)} /ΔT _J | Threshold Voltage temp. coefficient | — | -21 | — | mV/°C | V _{CE} = V _{GE} , I _C = 2.1mA (25°C - 175°C) |
| g _{fe} | Forward Transconductance | — | 50 | — | S | V _{CE} = 50V, I _C = 75A, PW = 60μs |
| I _{CES} | Collector-to-Emitter Leakage Current | — | 1.0 | 100 | μA | V _{GE} = 0V, V _{CE} = 600V |
| | | — | 1040 | — | | V _{GE} = 0V, V _{CE} = 600V, T _J = 175°C |
| V _{FM} | Diode Forward Voltage Drop | — | 2.23 | 3.0 | V | I _F = 75A |
| | | — | 1.8 | — | | I _F = 75A, T _J = 175°C |
| I _{GES} | Gate-to-Emitter Leakage Current | — | — | ±200 | nA | V _{GE} = ±20V |

Switching Characteristics @ T_J = 25°C (unless otherwise specified)

| | Parameter | Min. | Typ. | Max. | Units | Conditions |
|---------------------|--------------------------------------|-------------|------|------|-------|---|
| Q _g | Total Gate Charge (turn-on) | — | 150 | 225 | nC | I _C = 75A V _{GE} = 15V V _{CC} = 400V |
| Q _{ge} | Gate-to-Emitter Charge (turn-on) | — | 40 | 60 | | |
| Q _{gc} | Gate-to-Collector Charge (turn-on) | — | 60 | 90 | | |
| E _{on} | Turn-On Switching Loss | — | 2465 | 3360 | μJ | I _C = 75A, V _{CC} = 400V, V _{GE} = 15V R _G = 10Ω, L = 200μH, T _J = 25°C Energy losses include tail & diode reverse recovery |
| E _{off} | Turn-Off Switching Loss | — | 2155 | 3040 | | |
| E _{total} | Total Switching Loss | — | 4620 | 6400 | | |
| t _{d(on)} | Turn-On delay time | — | 50 | 70 | ns | I _C = 75A, V _{CC} = 400V, V _{GE} = 15V R _G = 10Ω, L = 200μH, T _J = 25°C |
| t _r | Rise time | — | 70 | 90 | | |
| t _{d(off)} | Turn-Off delay time | — | 200 | 225 | | |
| t _f | Fall time | — | 60 | 80 | | |
| E _{on} | Turn-On Switching Loss | — | 3870 | — | μJ | I _C = 75A, V _{CC} = 400V, V _{GE} = 15V R _G = 10Ω, L = 200μH, T _J = 175°C Energy losses include tail & diode reverse recovery |
| E _{off} | Turn-Off Switching Loss | — | 2815 | — | | |
| E _{total} | Total Switching Loss | — | 6685 | — | | |
| t _{d(on)} | Turn-On delay time | — | 50 | — | ns | I _C = 75A, V _{CC} = 400V, V _{GE} = 15V R _G = 10Ω, L = 200μH T _J = 175°C |
| t _r | Rise time | — | 70 | — | | |
| t _{d(off)} | Turn-Off delay time | — | 240 | — | | |
| t _f | Fall time | — | 70 | — | | |
| C _{ies} | Input Capacitance | — | 4440 | — | pF | V _{GE} = 0V V _{CC} = 30V f = 1.0Mhz |
| C _{oes} | Output Capacitance | — | 245 | — | | |
| C _{res} | Reverse Transfer Capacitance | — | 130 | — | | |
| RBSOA | Reverse Bias Safe Operating Area | FULL SQUARE | | | | T _J = 175°C, I _C = 300A V _{CC} = 480V, V _p ≤ 600V R _G = 10Ω, V _{GE} = +20V to 0V |
| SCSOA | Short Circuit Safe Operating Area | 5 | — | — | μs | V _{CC} = 400V, V _p ≤ 600V R _G = 10Ω, V _{GE} = +15V to 0V |
| E _{rec} | Reverse Recovery Energy of the Diode | — | 470 | — | μJ | T _J = 175°C |
| t _{rr} | Diode Reverse Recovery Time | — | 155 | — | ns | V _{CC} = 400V, I _F = 75A |
| I _{rr} | Peak Reverse Recovery Current | — | 27 | — | A | V _{GE} = 15V, R _G = 10Ω, L = 60μH |

Notes:

- ① V_{CC} = 80% (V_{CES}), V_{GE} = 20V, L = 10μH, R_G = 10Ω.
- ② Pulse width limited by max. junction temperature.
- ③ Refer to AN-1086 for guidelines for measuring V_{(BR)CES} safely.
- ④ R_G is measured at T_J of approximately 90°C.

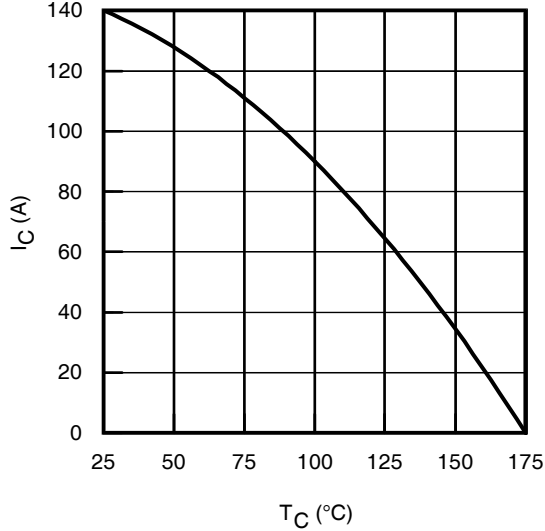

Fig. 1 - Maximum DC Collector Current vs. Case Temperature

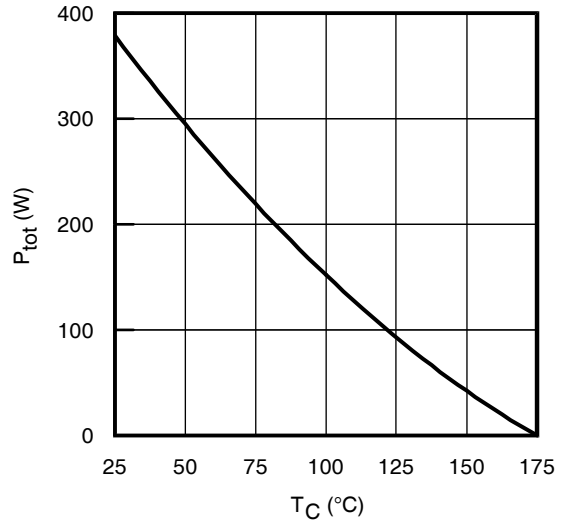

Fig. 2 - Power Dissipation vs. Case Temperature

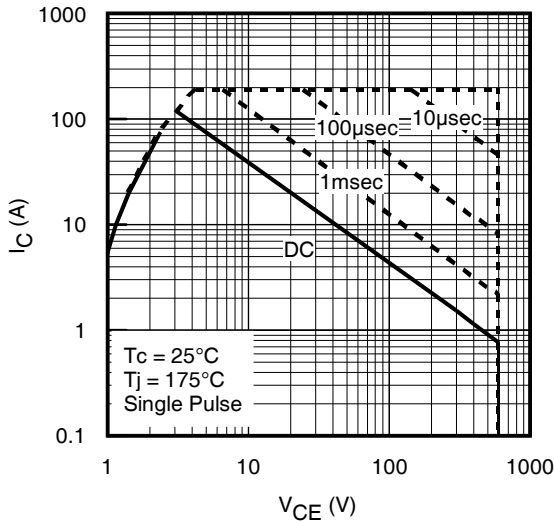

Fig. 3 - Forward SOA
 $T_C = 25^\circ\text{C}$, $T_J \leq 175^\circ\text{C}$; $V_{GE} = 15\text{V}$

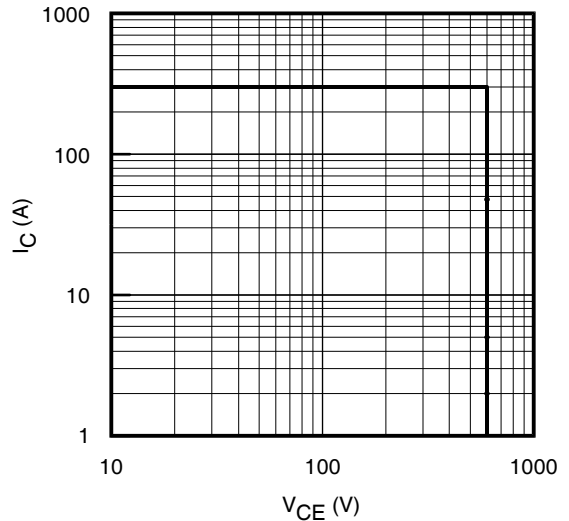

Fig. 4 - Reverse Bias SOA
 $T_J = 175^\circ\text{C}$; $V_{GE} = 20\text{V}$

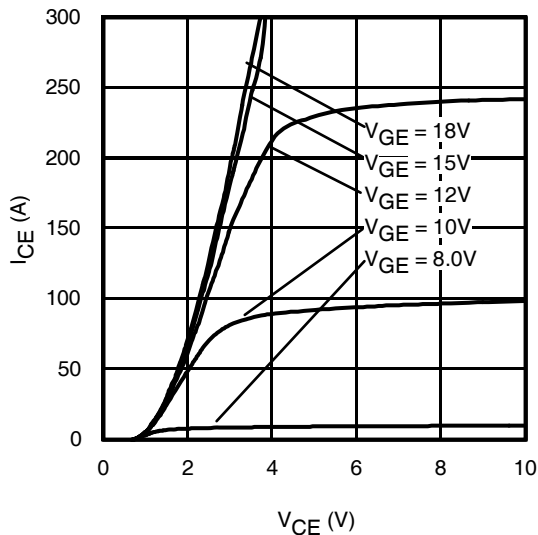

Fig. 5 - Typ. IGBT Output Characteristics
 $T_J = -40^\circ\text{C}$; $t_p \leq 60\mu\text{s}$

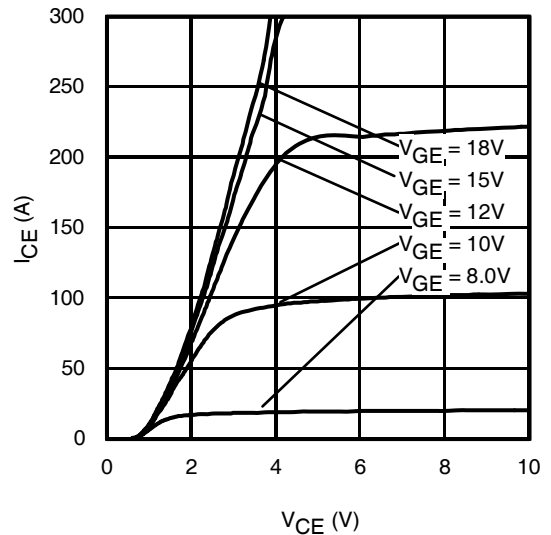

Fig. 6 - Typ. IGBT Output Characteristics
 $T_J = 25^\circ\text{C}$; $t_p \leq 60\mu\text{s}$

IRGP4066DPbF/IRGP4066D-EPbF

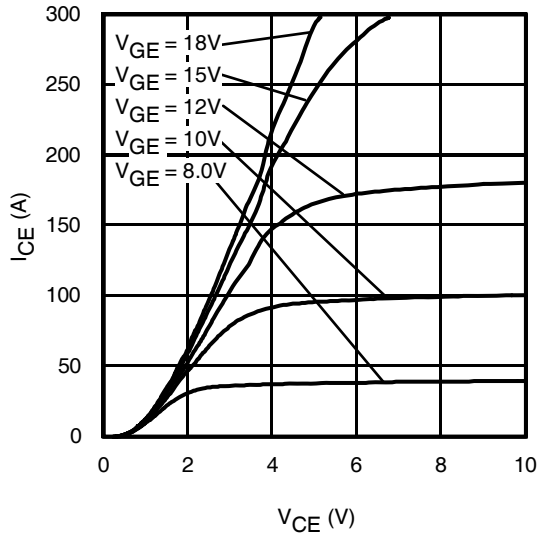

Fig. 7 - Typ. IGBT Output Characteristics
 $T_J = 175^\circ\text{C}$; $t_p = \leq 60\mu\text{s}$

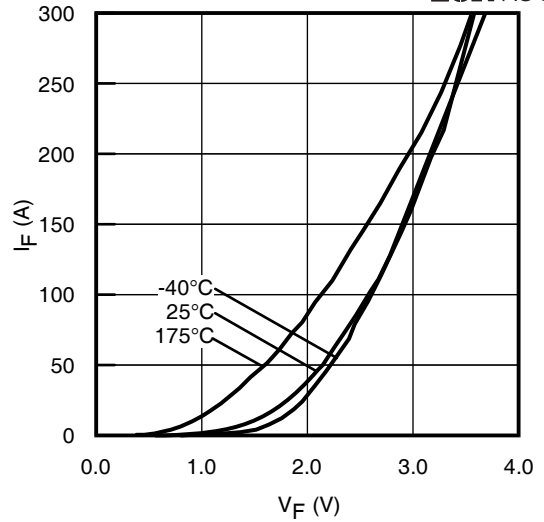

Fig. 8 - Typ. Diode Forward Characteristics
 $t_p = 80\mu\text{s}$

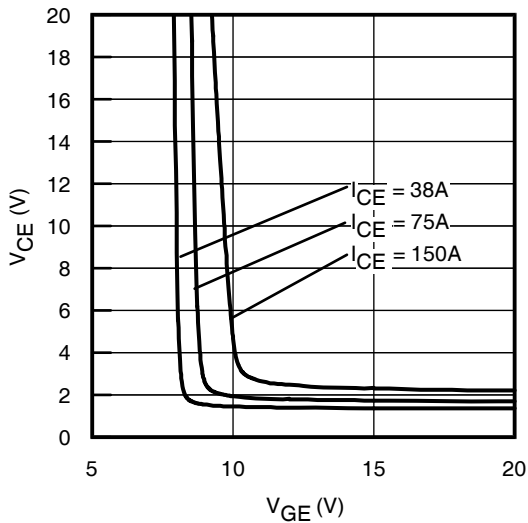

Fig. 9 - Typical V_{CE} vs. V_{GE}
 $T_J = -40^\circ\text{C}$

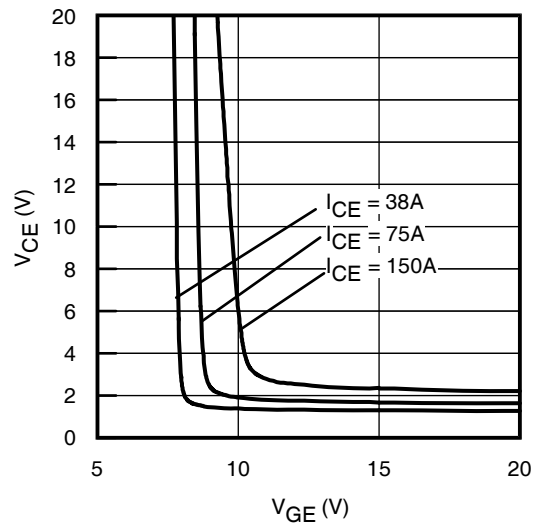

Fig. 10 - Typical V_{CE} vs. V_{GE}
 $T_J = 25^\circ\text{C}$

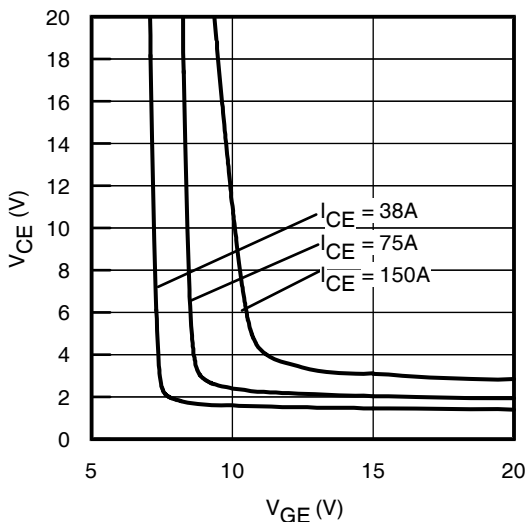

Fig. 11 - Typical V_{CE} vs. V_{GE}
 $T_J = 175^\circ\text{C}$

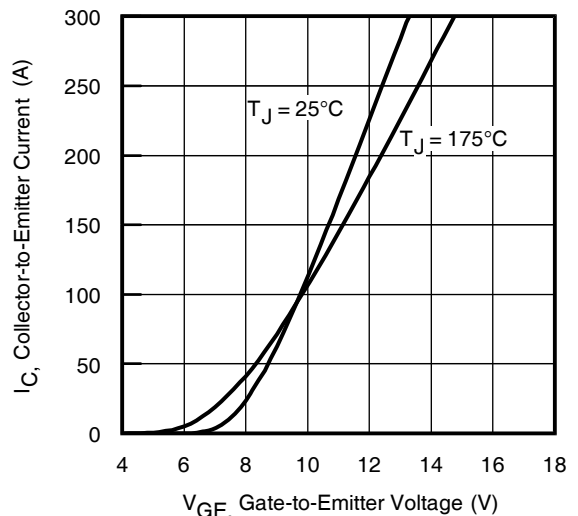

Fig. 12 - Typ. Transfer Characteristics
 $V_{CE} = 50\text{V}$; $t_p = 60\mu\text{s}$

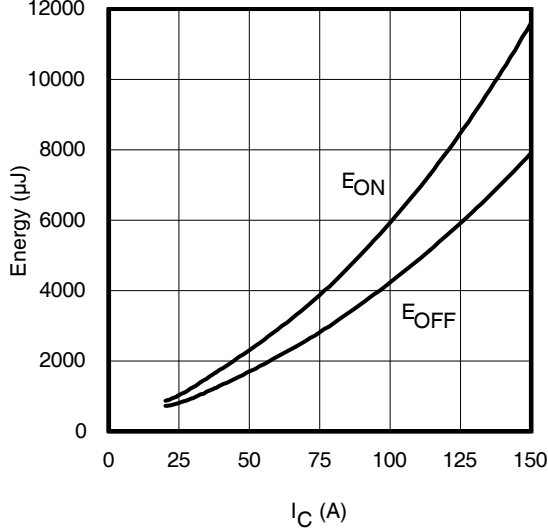

Fig. 13 - Typ. Energy Loss vs. I_C

$T_J = 175^\circ\text{C}$; $L = 200\mu\text{H}$; $V_{CE} = 400\text{V}$; $R_G = 10\Omega$; $V_{GE} = 15\text{V}$

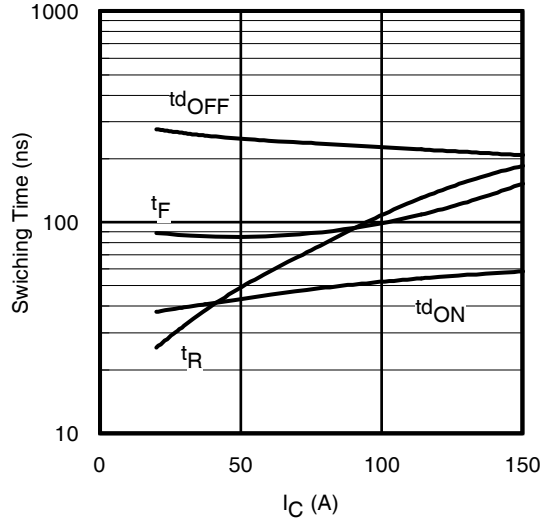

Fig. 14 - Typ. Switching Time vs. I_C

$T_J = 175^\circ\text{C}$; $L = 200\mu\text{H}$; $V_{CE} = 400\text{V}$; $R_G = 10\Omega$; $V_{GE} = 15\text{V}$

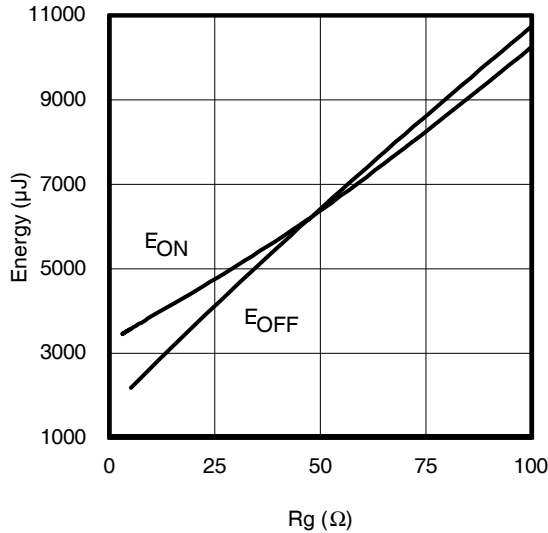

Fig. 15 - Typ. Energy Loss vs. R_G

$T_J = 175^\circ\text{C}$; $L = 200\mu\text{H}$; $V_{CE} = 400\text{V}$; $I_{CE} = 75\text{A}$; $V_{GE} = 15\text{V}$

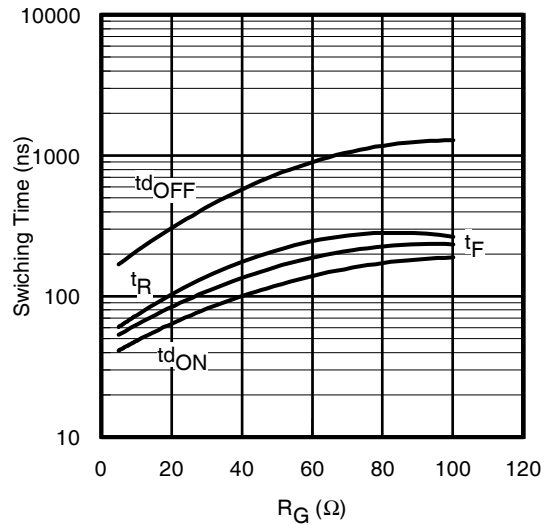

Fig. 16 - Typ. Switching Time vs. R_G

$T_J = 175^\circ\text{C}$; $L = 200\mu\text{H}$; $V_{CE} = 400\text{V}$; $I_{CE} = 75\text{A}$; $V_{GE} = 15\text{V}$

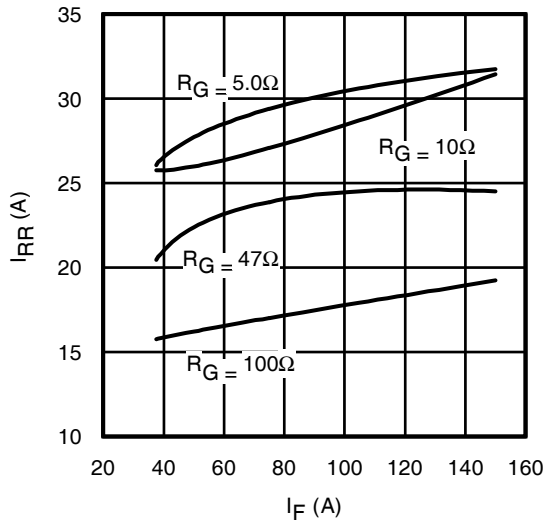

Fig. 17 - Typ. Diode I_{RR} vs. I_F

$T_J = 175^\circ\text{C}$

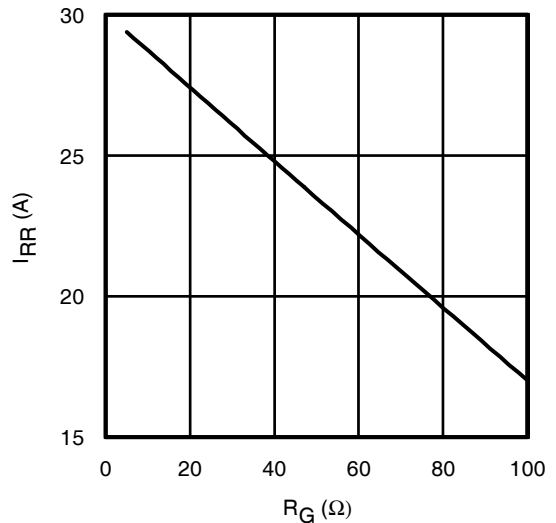

Fig. 18 - Typ. Diode I_{RR} vs. R_G

$T_J = 175^\circ\text{C}$

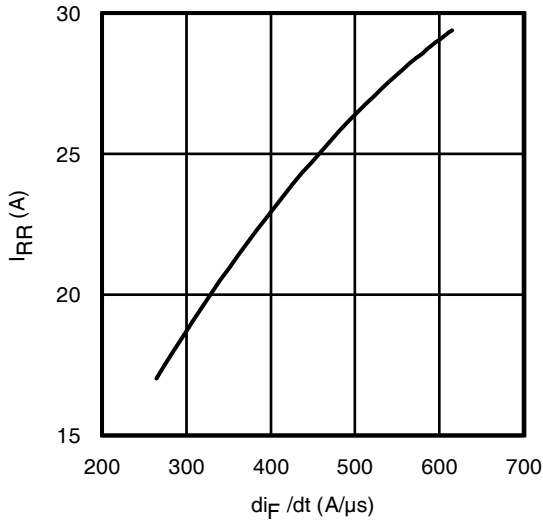

Fig. 19 - Typ. Diode I_{RR} vs. di_F/dt
 $V_{CC} = 400V$; $V_{GE} = 15V$; $I_F = 75A$; $T_J = 175^\circ C$

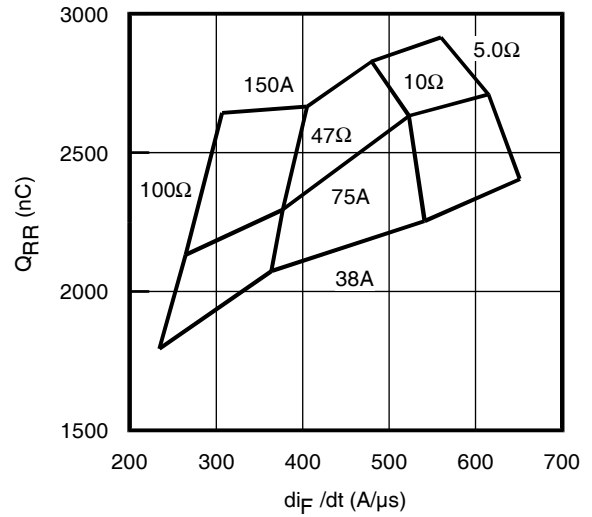

Fig. 20 - Typ. Diode Q_{RR} vs. di_F/dt
 $V_{CC} = 400V$; $V_{GE} = 15V$; $T_J = 175^\circ C$

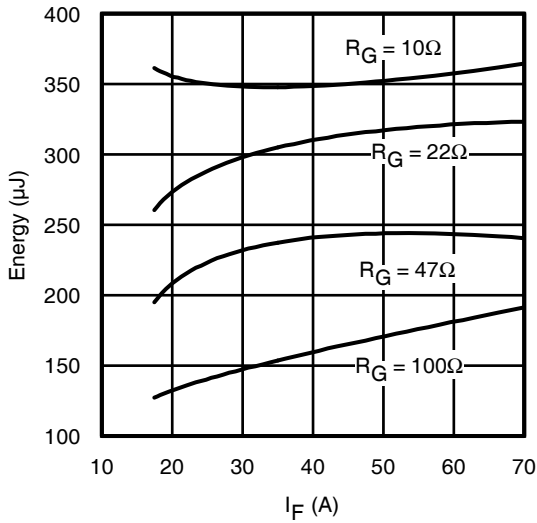

Fig. 21 - Typ. Diode E_{RR} vs. I_F
 $T_J = 175^\circ C$

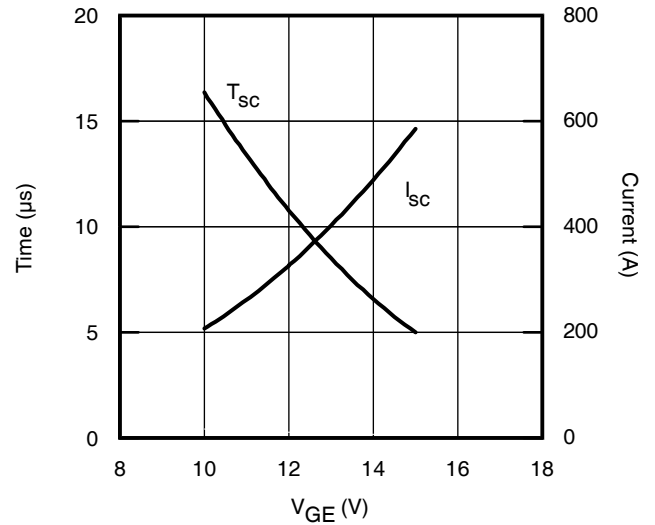

Fig. 22 - V_{GE} vs. Short Circuit Time
 $V_{CC} = 400V$; $T_C = 25^\circ C$

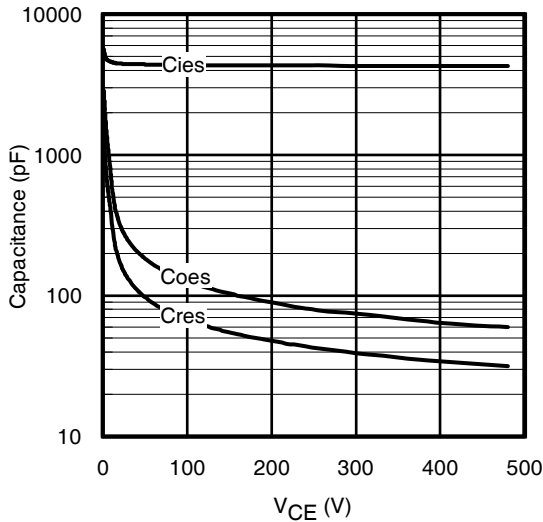

Fig. 23 - Typ. Capacitance vs. V_{CE}
 $V_{GE} = 0V$; $f = 1MHz$

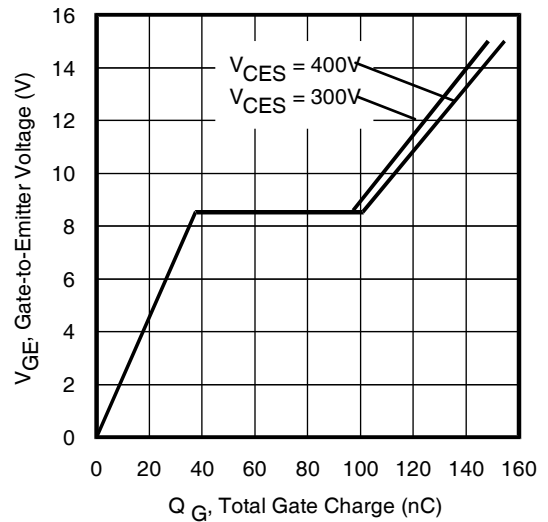

Fig. 24 - Typical Gate Charge vs. V_{GE}
 $I_{CE} = 75A$; $L = 485\mu H$

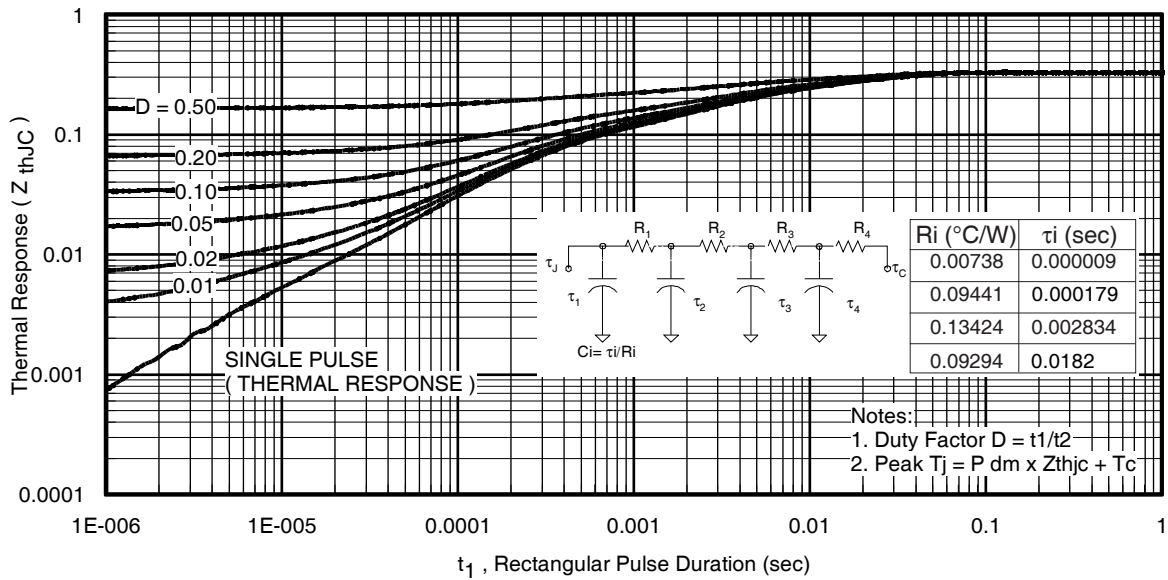

Fig 25. Maximum Transient Thermal Impedance, Junction-to-Case (IGBT)

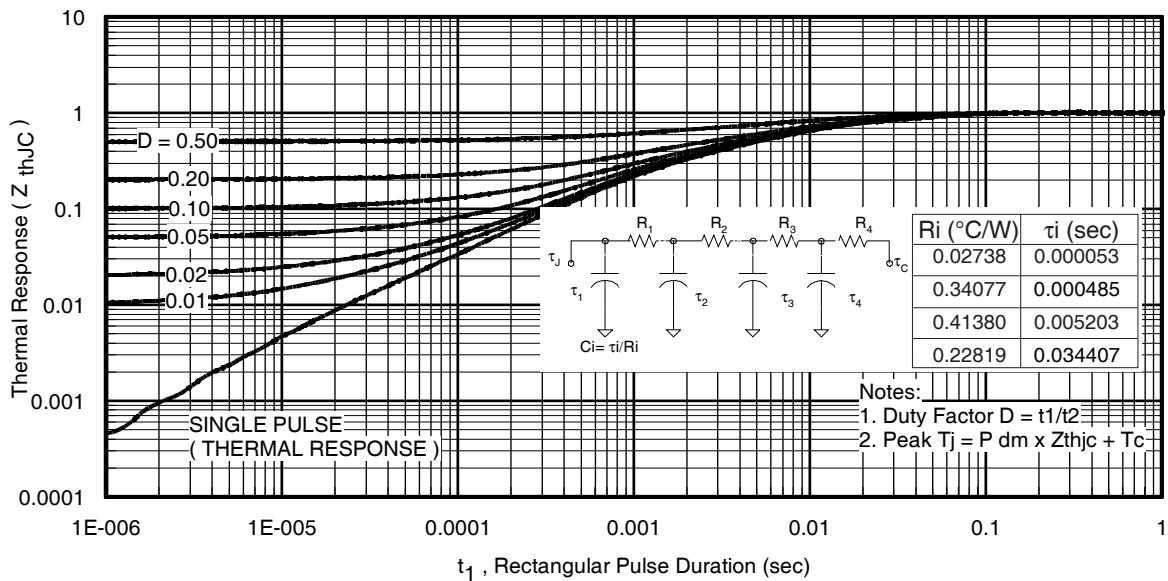

Fig. 26. Maximum Transient Thermal Impedance, Junction-to-Case (DIODE)



Fig.C.T.1 - Gate Charge Circuit (turn-off)

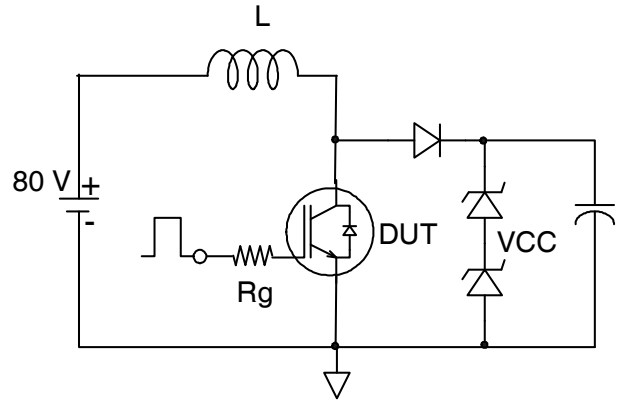

Fig.C.T.2 - RBSOA Circuit



Fig.C.T.3 - S.C. SOA Circuit

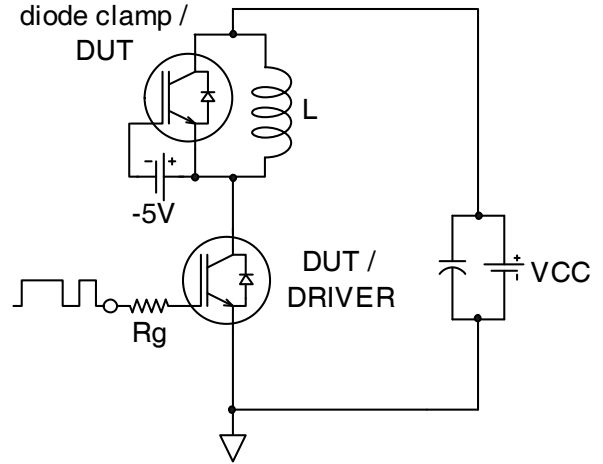

Fig.C.T.4 - Switching Loss Circuit



Fig.C.T.5 - Resistive Load Circuit

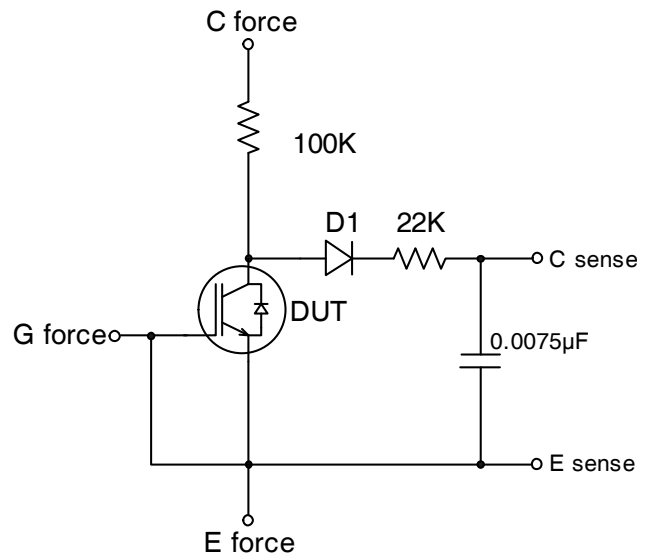

Fig.C.T.6 - BVCES Filter Circuit

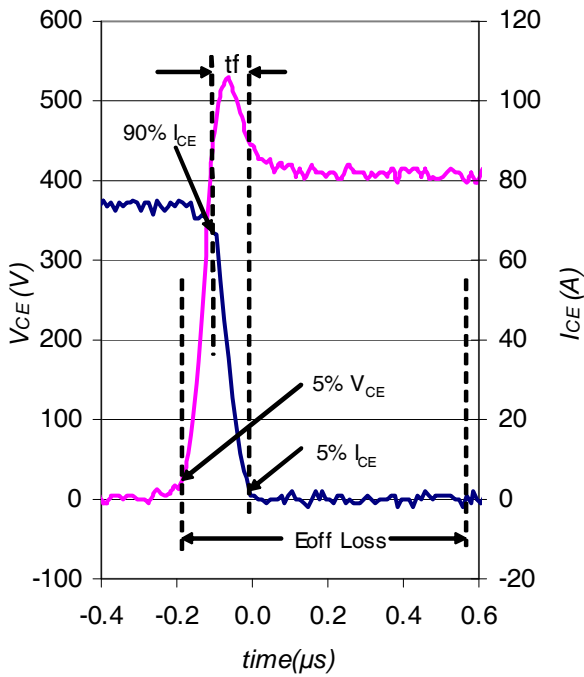

Fig. WF1 - Typ. Turn-off Loss Waveform
@ $T_J = 175^\circ C$ using Fig. CT.4

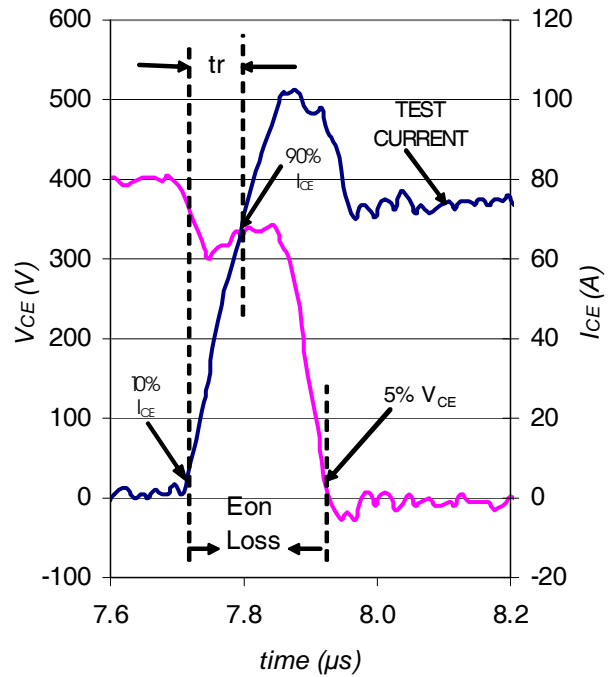

Fig. WF2 - Typ. Turn-on Loss Waveform
@ $T_J = 175^\circ C$ using Fig. CT.4

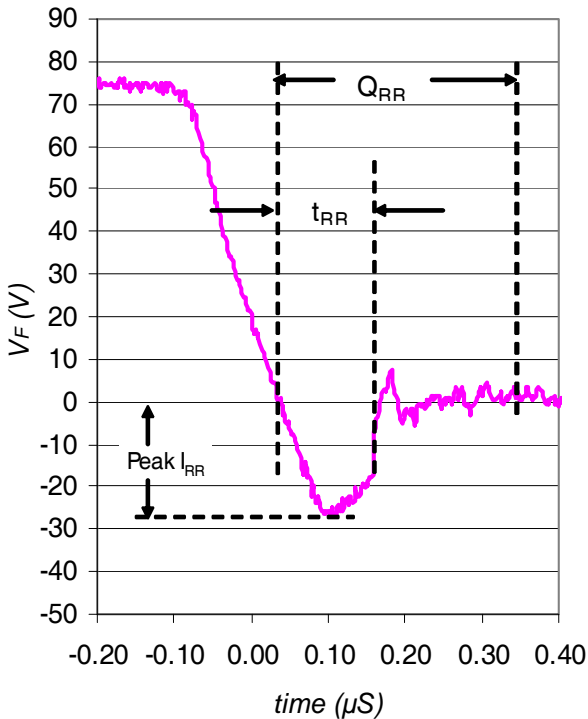

Fig. WF3 - Typ. Diode Recovery Waveform
@ $T_J = 175^\circ C$ using Fig. CT.4

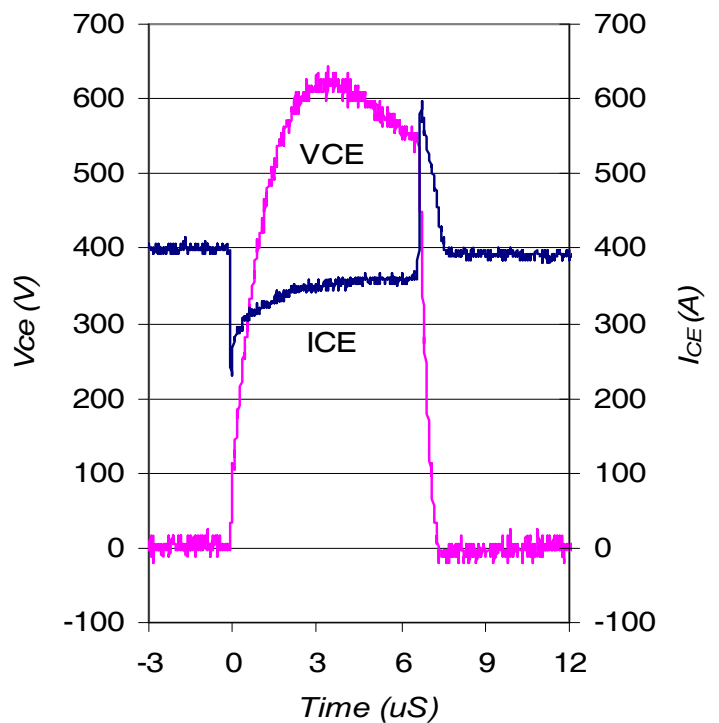

Fig. WF4 - Typ. S.C. Waveform
@ $T_J = 25^\circ C$ using Fig. CT.3

IRGP4066DPbF/IRGP4066D-EPbF

TO-247AC Package Outline

Dimensions are shown in millimeters (inches)



NOTES:

1. DIMENSIONING AND TOLERANCING AS PER ASME Y14.5M 1994.
2. DIMENSIONS ARE SHOWN IN INCHES.
3. CONTOUR OF SLOT OPTIONAL.
4. DIMENSION D & E DO NOT INCLUDE MOLD FLASH. MOLD FLASH SHALL NOT EXCEED .005" (0.127) PER SIDE. THESE DIMENSIONS ARE MEASURED AT THE OUTERMOST EXTREMES OF THE PLASTIC BODY.
5. THERMAL PAD CONTOUR OPTIONAL WITHIN DIMENSIONS D1 & E1.
6. LEAD FINISH UNCONTROLLED IN L1.
7. ϕP TO HAVE A MAXIMUM DRAFT ANGLE OF 1.5 ° TO THE TOP OF THE PART WITH A MAXIMUM HOLE DIAMETER OF .154 INCH.
8. OUTLINE CONFORMS TO JEDEC OUTLINE TO-247AC .

| SYMBOL | DIMENSIONS | | | | NOTES |
|-----------|------------|------|-------------|-------|-------|
| | INCHES | | MILLIMETERS | | |
| | MIN. | MAX. | MIN. | MAX. | |
| A | .183 | .209 | 4.65 | 5.31 | |
| A1 | .087 | .102 | 2.21 | 2.59 | |
| A2 | .059 | .098 | 1.50 | 2.49 | |
| b | .039 | .055 | 0.99 | 1.40 | |
| b1 | .039 | .053 | 0.99 | 1.35 | |
| b2 | .065 | .094 | 1.65 | 2.39 | |
| b3 | .065 | .092 | 1.65 | 2.34 | |
| b4 | .102 | .135 | 2.59 | 3.43 | |
| b5 | .102 | .133 | 2.59 | 3.38 | |
| c | .015 | .035 | 0.38 | 0.89 | |
| c1 | .015 | .033 | 0.38 | 0.84 | |
| D | .776 | .815 | 19.71 | 20.70 | 4 |
| D1 | .515 | - | 13.08 | - | 5 |
| D2 | .020 | .053 | 0.51 | 1.35 | |
| E | .602 | .625 | 15.29 | 15.87 | 4 |
| E1 | .530 | - | 13.46 | - | |
| E2 | .178 | .216 | 4.52 | 5.49 | |
| e | .215 BSC | | 5.46 BSC | | |
| ϕk | .010 | | 0.25 | | |
| L | .559 | .634 | 14.20 | 16.10 | |
| L1 | .146 | .169 | 3.71 | 4.29 | |
| ϕP | .140 | .144 | 3.56 | 3.66 | |
| $\phi P1$ | - | .291 | - | 7.39 | |
| Q | .209 | .224 | 5.31 | 5.69 | |
| S | .217 BSC | | 5.51 BSC | | |

LEAD ASSIGNMENTS

HEXFET

- 1.- GATE
- 2.- DRAIN
- 3.- SOURCE
- 4.- DRAIN

IGBTs, CoPACK

- 1.- GATE
- 2.- COLLECTOR
- 3.- EMITTER
- 4.- COLLECTOR

DIODES

- 1.- ANODE/OPEN
- 2.- CATHODE
- 3.- ANODE

TO-247AC Part Marking Information

EXAMPLE: THIS IS AN IRFPE30
WITH ASSEMBLY
LOT CODE 5657
ASSEMBLED ON WW 35, 2001
IN THE ASSEMBLY LINE "H"

Note: "P" in assembly line position
indicates "Lead-Free"

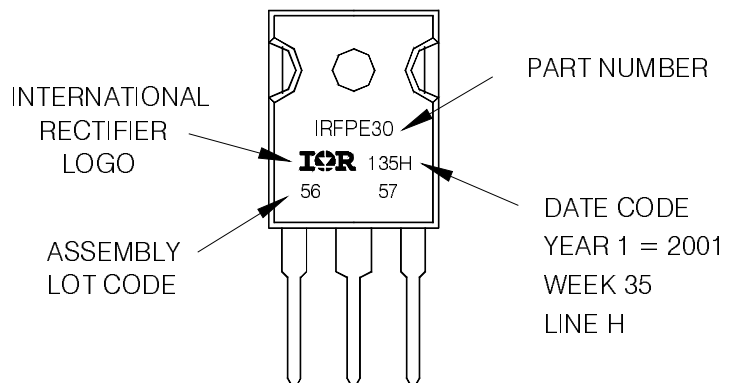

TO-247AC package is not recommended for Surface Mount Application.

Note: For the most current drawing please refer to IR website at <http://www.irf.com/package/>

TO-247AD Package Outline

Dimensions are shown in millimeters (inches)



NOTES:

1. DIMENSIONING AND TOLERANCING AS PER ASME Y14.5M 1994.
2. DIMENSIONS ARE SHOWN IN INCHES.
3. CONTOUR OF SLOT OPTIONAL.
4. DIMENSION D & E DO NOT INCLUDE MOLD FLASH. MOLD FLASH SHALL NOT EXCEED .005" (0.127) PER SIDE. THESE DIMENSIONS ARE MEASURED AT THE OUTERMOST EXTREMES OF THE PLASTIC BODY.
5. THERMAL PAD CONTOUR OPTIONAL WITHIN DIMENSIONS D1 & E1.
6. LEAD FINISH UNCONTROLLED IN L1.
7. ϕP TO HAVE A MAXIMUM DRAFT ANGLE OF 1.5 ° TO THE TOP OF THE PART WITH A MAXIMUM HOLE DIAMETER OF .154 INCH.
8. OUTLINE CONFORMS TO JEDEC OUTLINE TO-247AD.

| SYMBOL | DIMENSIONS | | | | NOTES |
|-----------|------------|------|-------------|-------|-------|
| | INCHES | | MILLIMETERS | | |
| | MIN. | MAX. | MIN. | MAX. | |
| A | .183 | .209 | 4.65 | 5.31 | |
| A1 | .087 | .102 | 2.21 | 2.59 | |
| A2 | .059 | .098 | 1.50 | 2.49 | |
| b | .039 | .055 | 0.99 | 1.40 | |
| b1 | .039 | .053 | 0.99 | 1.35 | |
| b2 | .065 | .094 | 1.65 | 2.39 | |
| b3 | .065 | .092 | 1.65 | 2.34 | |
| b4 | .102 | .135 | 2.59 | 3.43 | |
| b5 | .102 | .133 | 2.59 | 3.38 | |
| c | .015 | .035 | 0.38 | 0.89 | |
| c1 | .015 | .033 | 0.38 | 0.84 | |
| D | .776 | .815 | 19.71 | 20.70 | 4 |
| D1 | .515 | - | 13.08 | - | 5 |
| D2 | .020 | .053 | 0.51 | 1.35 | |
| E | .602 | .625 | 15.29 | 15.87 | 4 |
| E1 | .530 | - | 13.46 | - | |
| E2 | .178 | .216 | 4.52 | 5.49 | |
| e | .215 BSC | | 5.46 BSC | | |
| ϕk | .010 | | 0.25 | | |
| L | .780 | .827 | 19.57 | 21.00 | |
| L1 | .146 | .169 | 3.71 | 4.29 | |
| ϕP | .140 | .144 | 3.56 | 3.66 | |
| $\phi P1$ | - | .291 | - | 7.39 | |
| Q | .209 | .224 | 5.31 | 5.69 | |
| S | .217 BSC | | 5.51 BSC | | |

LEAD ASSIGNMENTS

- HEXFET**
- 1.- GATE
 - 2.- DRAIN
 - 3.- SOURCE
 - 4.- DRAIN

IGBTs, CoPACK

- 1.- GATE
- 2.- COLLECTOR
- 3.- EMITTER
- 4.- COLLECTOR

DIGIDES

- 1.- ANODE/OPEN
- 2.- CATHODE
- 3.- ANODE

TO-247AD Part Marking Information

EXAMPLE: THIS IS AN IRGP30B120KD-E
WITH ASSEMBLY
LOT CODE 5657
ASSEMBLED ON WW 35, 2000
IN THE ASSEMBLY LINE "H"

Note: "P" in assembly line position
indicates "Lead-Free"

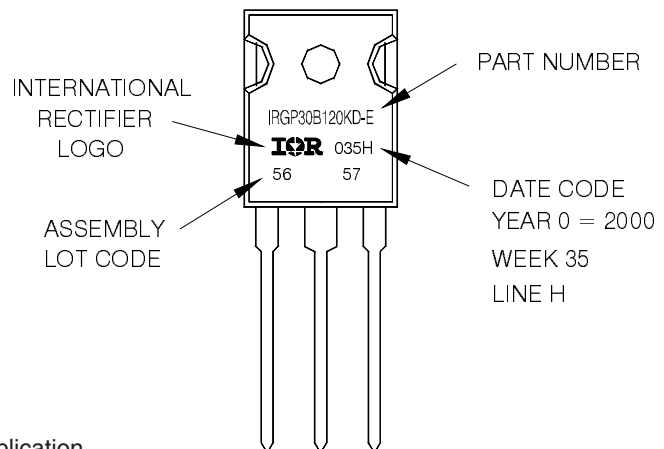

TO-247AD package is not recommended for Surface Mount Application.

Note: For the most current drawing please refer to IR website at <http://www.irf.com/package/>

Data and specifications subject to change without notice.
This product has been designed and qualified for Industrial market.
Qualification Standards can be found on IR's Web site.



Стандарт Электрон Связь

Мы молодая и активно развивающаяся компания в области поставок электронных компонентов. Мы поставляем электронные компоненты отечественного и импортного производства напрямую от производителей и с крупнейших складов мира.

Благодаря сотрудничеству с мировыми поставщиками мы осуществляем комплексные и плановые поставки широчайшего спектра электронных компонентов.

Собственная эффективная логистика и склад в обеспечивает надежную поставку продукции в точно указанные сроки по всей России.

Мы осуществляем техническую поддержку нашим клиентам и предпродажную проверку качества продукции. На все поставляемые продукты мы предоставляем гарантию .

Осуществляем поставки продукции под контролем ВП МО РФ на предприятия военно-промышленного комплекса России , а также работаем в рамках 275 ФЗ с открытием отдельных счетов в уполномоченном банке. Система менеджмента качества компании соответствует требованиям ГОСТ ISO 9001.

Минимальные сроки поставки, гибкие цены, неограниченный ассортимент и индивидуальный подход к клиентам являются основой для выстраивания долгосрочного и эффективного сотрудничества с предприятиями радиоэлектронной промышленности, предприятиями ВПК и научно-исследовательскими институтами России.

С нами вы становитесь еще успешнее!

Наши контакты:

Телефон: +7 812 627 14 35

Электронная почта: sales@st-electron.ru

Адрес: 198099, Санкт-Петербург,
Промышленная ул, дом № 19, литера Н,
помещение 100-Н Офис 331