



+5V, Serial-Input, Voltage-Output, 14-Bit DACs

MAX544/MAX545

General Description

The MAX544/MAX545 are serial-input, voltage-output, 14-bit digital-to-analog converters (DACs) that operate from a single +5V supply. They provide 14-bit performance ($\pm 0.5\text{LSB INL}$ and $\pm 0.9\text{LSB DNL}$) over temperature without any adjustments. The DAC output is unbuffered, resulting in a low supply current of 0.3mA and a low offset error of 0.6mV.

The DAC output range is 0V to V_{REF} . For bipolar operation, matched scaling resistors are provided in the MAX545 for use with an external precision op amp (such as the MAX400), generating a $\pm V_{REF}$ output swing. The MAX545 also includes Kelvin-sense connections for the reference and analog ground pins to reduce layout sensitivity.

A 16-bit serial word is used to load data into the DAC latch. The 10MHz, 3-wire serial interface is compatible with SPI™/QSPI™/MICROWIRE™, and it also interfaces directly with optocouplers for applications requiring isolation. A power-on reset circuit clears the DAC output to 0V (unipolar mode) when power is initially applied.

The MAX544 is available in 8-pin plastic DIP and SO packages. The MAX545 is available in 14-pin plastic DIP and SO packages.

Applications

- Digital Offset and Gain Adjustment
- Instrumentation
- Industrial Process Control
- Automated Test Equipment
- Data-Acquisition Systems

Pin Configurations

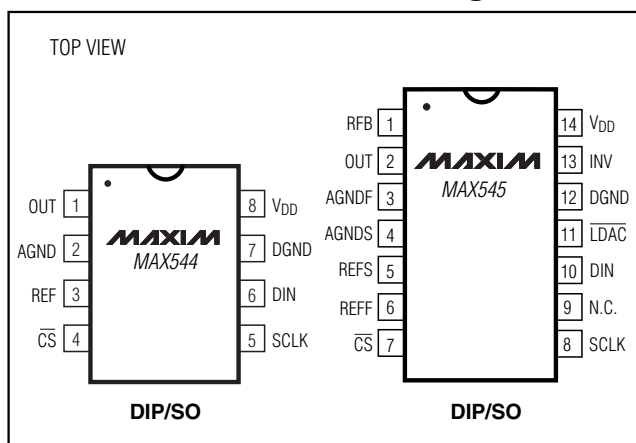

SPI and QSPI are trademarks of Motorola, Inc.
MICROWIRE is a trademark of National Semiconductor Corp.

Features

- ◆ Full 14-Bit Performance Without Adjustments
- ◆ +5V Single-Supply Operation
- ◆ Low Power: 1.5mW
- ◆ 1 μ s Settling Time
- ◆ Unbuffered Voltage Output Directly Drives 60k Ω Loads
- ◆ SPI/QSPI/MICROWIRE-Compatible Serial Interface
- ◆ Power-On Reset Circuit Clears DAC Output to 0V (unipolar mode)
- ◆ Schmitt-Trigger Inputs for Direct Optocoupler Interface
- ◆ Pin-Compatible 16-Bit Upgrades (MAX541/MAX542)

Ordering Information

PART	TEMP. RANGE	PIN-PACKAGE	INL (LSB)
MAX544ACPA	0°C to +70°C	8 Plastic DIP	$\pm 1/2$
MAX544BCPA	0°C to +70°C	8 Plastic DIP	± 1
MAX544ACSA	0°C to +70°C	8 SO	$\pm 1/2$
MAX544BCSA	0°C to +70°C	8 SO	± 1

Ordering Information continued at end of data sheet.

Functional Diagrams

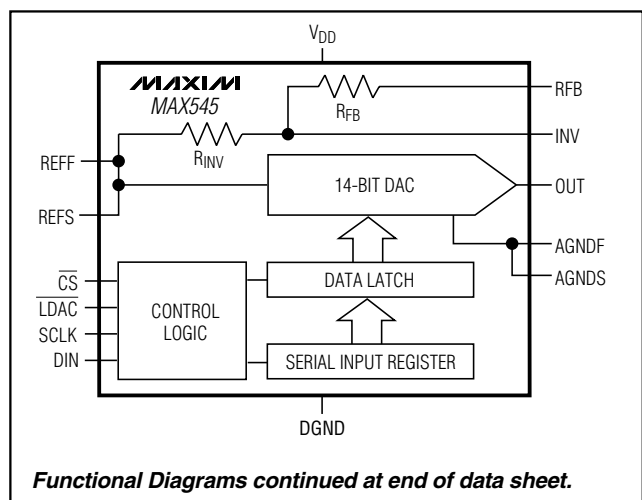

Functional Diagrams continued at end of data sheet.



For free samples & the latest literature: <http://www.maxim-ic.com>, or phone 1-800-998-8800.
For small orders, phone 1-800-835-8769.

+5V, Serial-Input, Voltage-Output, 14-Bit DACs

ABSOLUTE MAXIMUM RATINGS

V _{DD} to DGND	-0.3V to +6V	14-Pin Plastic DIP (derate 10.00mW/°C above +70°C)...	800mW
CS, SCLK, DIN, LDAC to DGND	-0.3V to +6V	14-Pin SO (derate 8.33mW/°C above +70°C)	667mW
REF, REFF, REFS to AGND	-0.3V to (V _{DD} + 0.3V)	14-Pin Ceramic SB (derate 10.00mW/°C above +70°C)...	800mW
AGND, AGNDF, AGNDS to DGND	-0.3V to +0.3V	Operating Temperature Ranges	
OUT, INV to AGND DGND	-0.3V to V _{DD}	MAX544 _C_ A/MAX545 _C_ D	0°C to +70°C
RFB to AGND DGND	-6V to +6V	MAX544 _E_ A/MAX545 _E_ D	-40°C to +85°C
Maximum Current into Any Pin.....	50mA	MAX545BMJD	-55°C to +125°C
Continuous Power Dissipation (T _A = +70°C)		Storage Temperature Range	-65°C to +150°C
8-Pin Plastic DIP (derate 9.09mW/°C above +70°C)	727mW	Lead Temperature (soldering, 10s)	+300°C
8-Pin SO (derate 5.88mW/°C above +70°C)	471mW		

Stresses beyond those listed under "Absolute Maximum Ratings" may cause permanent damage to the device. These are stress ratings only, and functional operation of the device at these or any other conditions beyond those indicated in the operational sections of the specifications is not implied. Exposure to absolute maximum rating conditions for extended periods may affect device reliability.

ELECTRICAL CHARACTERISTICS

(V_{DD} = +5V ± 5%, V_{REF} = +2.5V, AGND = DGND = 0, T_A = T_{MIN} to T_{MAX}, unless otherwise noted.)

PARAMETER	SYMBOL	CONDITIONS		MIN	TYP	MAX	UNITS
STATIC PERFORMANCE—ANALOG SECTION (R_L = ∞)							
Resolution	N			14			Bits
Integral Nonlinearity	INL	V _{DD} = 5V	MAX54_A	±0.15	±0.5		LSB
			MAX54_B	±0.15	±1		
Differential Nonlinearity	DNL	Guaranteed monotonic			±0.15	±0.9	LSB
Zero-Code Offset Error	ZSE					±0.6	mV
Zero-Code Tempco	ZSTC				±0.05		ppm/°C
Gain Error (Note 1)						±5	LSB
Gain-Error Tempco					±0.1		ppm/°C
DAC Output Resistance	R _{OUT}	(Note 2)			6.25		kΩ
Bipolar Resistor Matching		MAX545	RFB/R _{INV}	1.0			
			Ratio error		±0.03		%
Bipolar Zero Offset Error		MAX545				±10	LSB
Bipolar Zero Tempco	BZSTC	MAX545			±0.5		ppm/°C
Power-Supply Rejection	PSR	4.75V ≤ V _{DD} ≤ 5.25V				±1.0	LSB
REFERENCE INPUT							
Reference Input Range	V _{REF}	(Note 3)		2.0		3.0	V
Reference Input Resistance (Note 4)	R _{REF}	Unipolar mode		11.5			kΩ
		MAX545, bipolar mode		9.0			
DYNAMIC PERFORMANCE—ANALOG SECTION (R_L = ∞, unipolar mode)							
Voltage-Output Slew Rate	SR	C _L = 10pF (Note 5)			25		V/μs
Output Settling Time		To ± 1/2LSB of FS, C _L = 10pF			1		μs
DAC Glitch Impulse		Major-carry transition			10		nVs
Digital Feedthrough		Code = 0000 hex; \overline{CS} = V _{DD} ; \overline{LDAC} = 0V; SCLK, DIN = 0V to V _{DD} levels			10		nVs

+5V, Serial-Input, Voltage-Output, 14-Bit DACs

MAX544/MAX545

ELECTRICAL CHARACTERISTICS (continued)

(V_{DD} = +5V ± 5%, V_{REF} = +2.5V, AGND = DGND = 0, T_A = T_{MIN} to T_{MAX}, unless otherwise noted.)

PARAMETER	SYMBOL	CONDITIONS	MIN	TYP	MAX	UNITS
DYNAMIC PERFORMANCE—REFERENCE SECTION						
Reference -3dB Bandwidth	BW	Code = FFFC hex		1		MHz
Reference Feedthrough		Code = 0000 hex, V _{REF} = 1Vp-p at 100kHz		1		mVp-p
Signal-to-Noise Ratio	SNR			83		dB
Reference Input Capacitance	C _{IN}	Code = 0000 hex		75		pF
		Code = FFFC hex		120		
STATIC PERFORMANCE—DIGITAL INPUTS						
Input High Voltage	V _{IH}		2.4			V
Input Low Voltage	V _{IL}				0.8	V
Input Current	I _{IN}	V _{IN} = 0			±1	μA
Input Capacitance	C _{IN}	(Note 6)			10	pF
Hysteresis Voltage	V _H			0.40		V
POWER SUPPLY						
Positive Supply Range	V _{DD}		4.75		5.25	V
Positive Supply Current	I _{DD}			0.3	1.1	mA
Power Dissipation	PD			1.5		mW

TIMING CHARACTERISTICS

(V_{DD} = +5V ± 5%, V_{REF} = +2.5V, AGND = DGND = 0, CMOS inputs, T_A = T_{MIN} to T_{MAX}, unless otherwise noted.)

PARAMETER	SYMBOL	CONDITIONS	MIN	TYP	MAX	UNITS
SCLK Frequency	f _{SCLK}				10	MHz
SCLK Pulse Width High	t _{CH}		45			ns
SCLK Pulse Width Low	t _{CL}		45			ns
$\overline{\text{CS}}$ Low to SCLK High Setup	t _{CSS0}		45			ns
$\overline{\text{CS}}$ High to SCLK High Setup	t _{CSS1}		45			ns
SCLK High to $\overline{\text{CS}}$ Low Hold	t _{CSH0}	(Note 6)	30			ns
SCLK High to $\overline{\text{CS}}$ High Hold	t _{CSH1}		45			ns
DIN to SCLK High Setup	t _{DS}		40			ns
DIN to SCLK High Hold	t _{DH}		0			ns
$\overline{\text{LDAC}}$ Pulse Width	t _{LDAC}	MAX545	50			ns
$\overline{\text{CS}}$ High to $\overline{\text{LDAC}}$ Low Setup	t _{LDACS}	MAX545 (Note 6)	50			ns
V _{DD} High to $\overline{\text{CS}}$ Low (power-up delay)				20		μs

Note 1: Gain Error tested at V_{REF} = 2.0V, 2.5V, and 3.0V.

Note 2: R_{OUT} tolerance is typically ±20%.

Note 3: Min/max range guaranteed by gain-error test. Operation outside min/max limits will result in degraded performance.

Note 4: Reference input resistance is code dependent, minimum at 8554 hex.

Note 5: Slew-rate value is measured from 0% to 63%.

Note 6: Guaranteed by design. Not production tested.

+5V, Serial-Input, Voltage-Output, 14-Bit DACs

Typical Operating Characteristics

($V_{DD} = 5V$, $V_{REF} = +2.5V$, $T_A = +25^\circ C$, unless otherwise noted.)

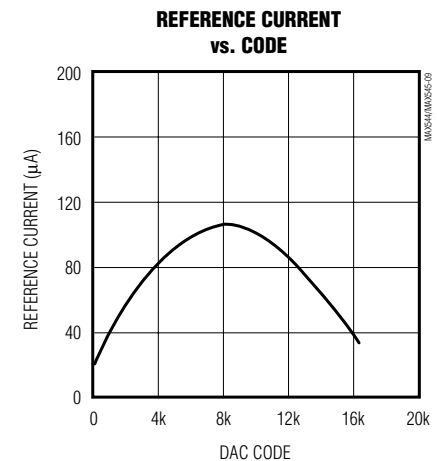
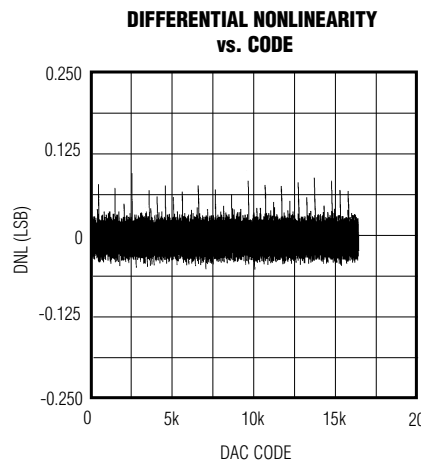
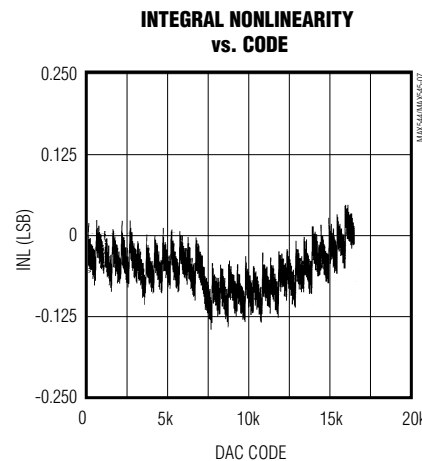
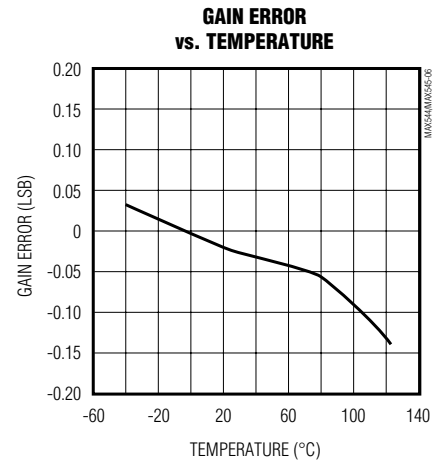
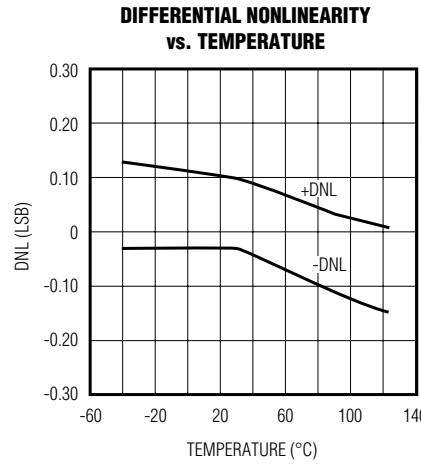
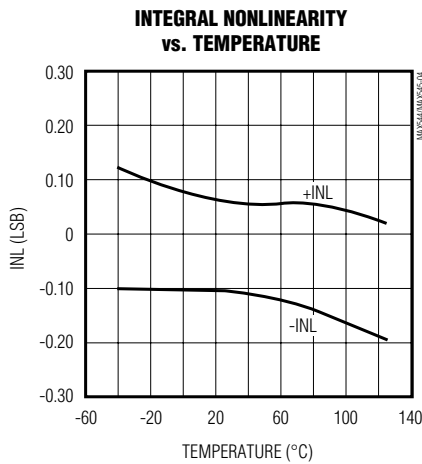
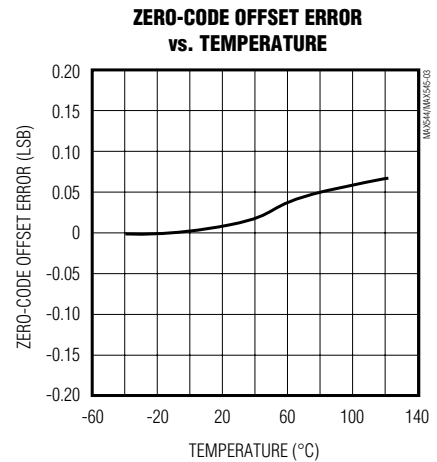
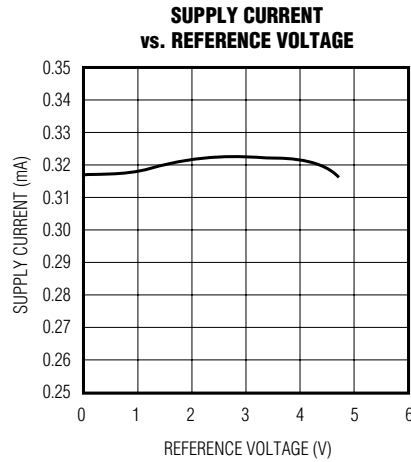
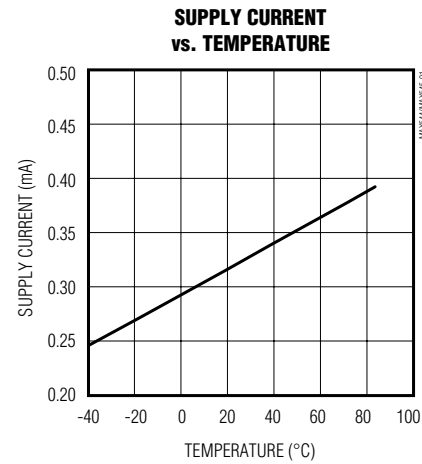

+5V, Serial-Input, Voltage-Output, 14-Bit DACs

MAX544/MAX545

Typical Operating Characteristics (continued)

(V_{DD} = +5V, V_{REF} = +2.5V, T_A = +25°C, unless otherwise noted.)

FULL-SCALE STEP RESPONSE
(f_{SCLK} = 10MHz)

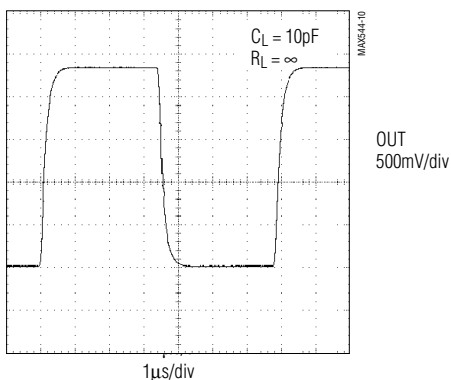

FULL-SCALE STEP RESPONSE
(f_{SCLK} = 20MHz)

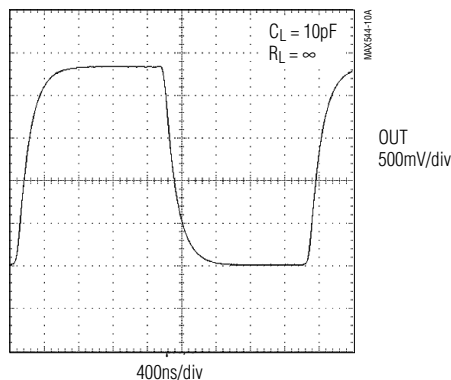

MAJOR-CARRY OUTPUT GLITCH

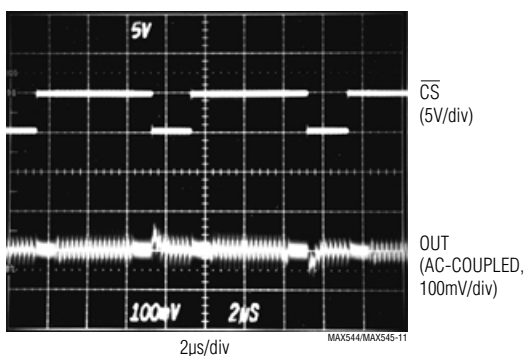

DIGITAL FEEDTHROUGH

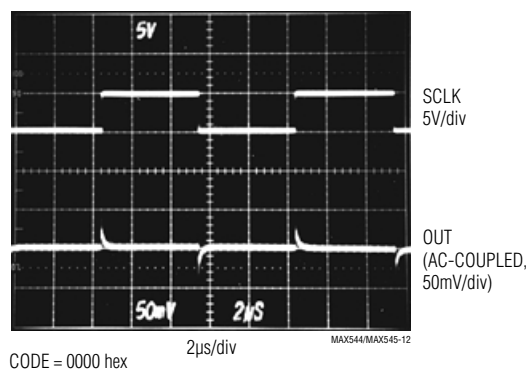

Pin Descriptions

MAX544

PIN	NAME	FUNCTION
1	OUT	DAC Output Voltage
2	AGND	Analog Ground
3	REF	Voltage Reference Input. Connect to external +2.5V reference.
4	$\overline{\text{CS}}$	Chip-Select Input
5	SCLK	Serial-Clock Input. Duty cycle must be between 40% and 60%.
6	DIN	Serial-Data Input
7	DGND	Digital Ground
8	V _{DD}	+5V Supply Voltage

+5V, Serial-Input, Voltage-Output, 14-Bit DACs

Pin Descriptions (continued)

MAX545

PIN	NAME	FUNCTION
1	RFB	Feedback Resistor. Connect to external op amp's output in bipolar mode.
2	OUT	DAC Output Voltage
3	AGNDF	Analog Ground (force)
4	AGNDS	Analog Ground (sense)
5	REFS	Voltage Reference Input (sense). Connect REFS to external +2.5V reference.
6	REFF	Voltage Reference Input (force). Connect REFF to external +2.5V reference.
7	\overline{CS}	Chip-Select Input
8	SCLK	Serial-Clock Input. Duty cycle must be between 40% and 60%.
9	N.C.	No Connection. Not internally connected.
10	DIN	Serial-Data Input
11	\overline{LDAC}	\overline{LDAC} Input. A falling edge updates the internal DAC latch.
12	DGND	Digital Ground
13	INV	Junction of internal scaling resistors. Connect to external op amp's inverting input in bipolar mode.
14	VDD	+5V Supply Voltage

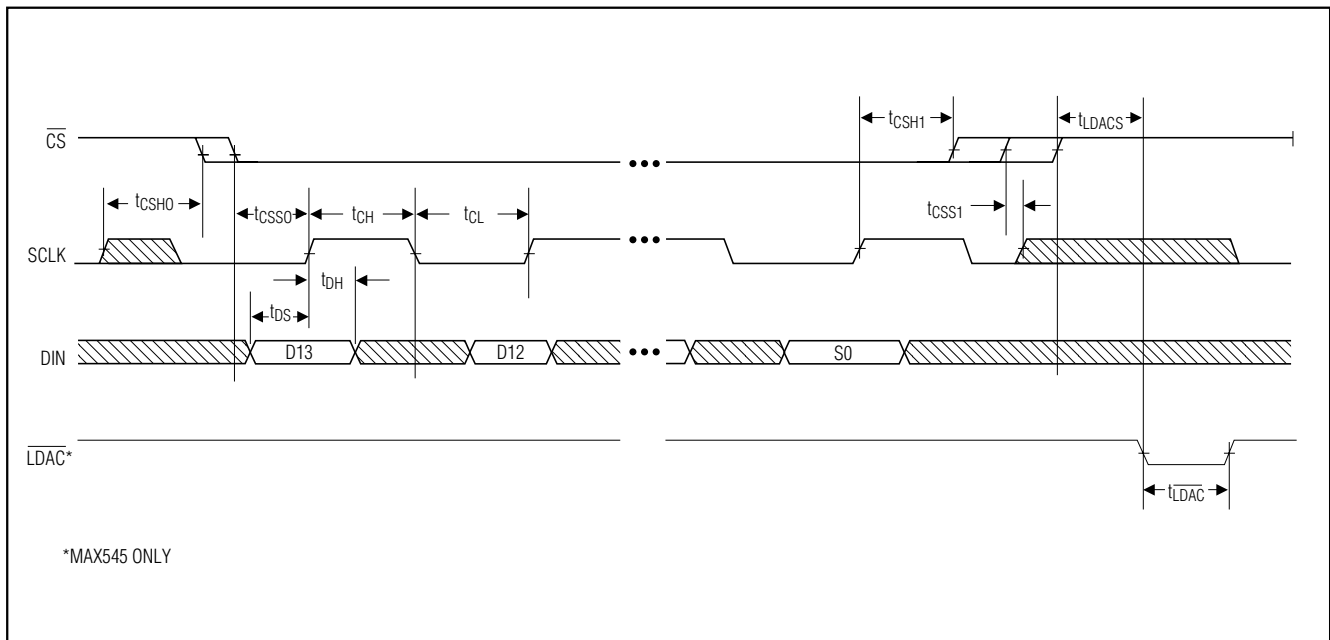

Figure 1. Timing Diagram

+5V, Serial-Input, Voltage-Output, 14-Bit DACs

MAX544/MAX545

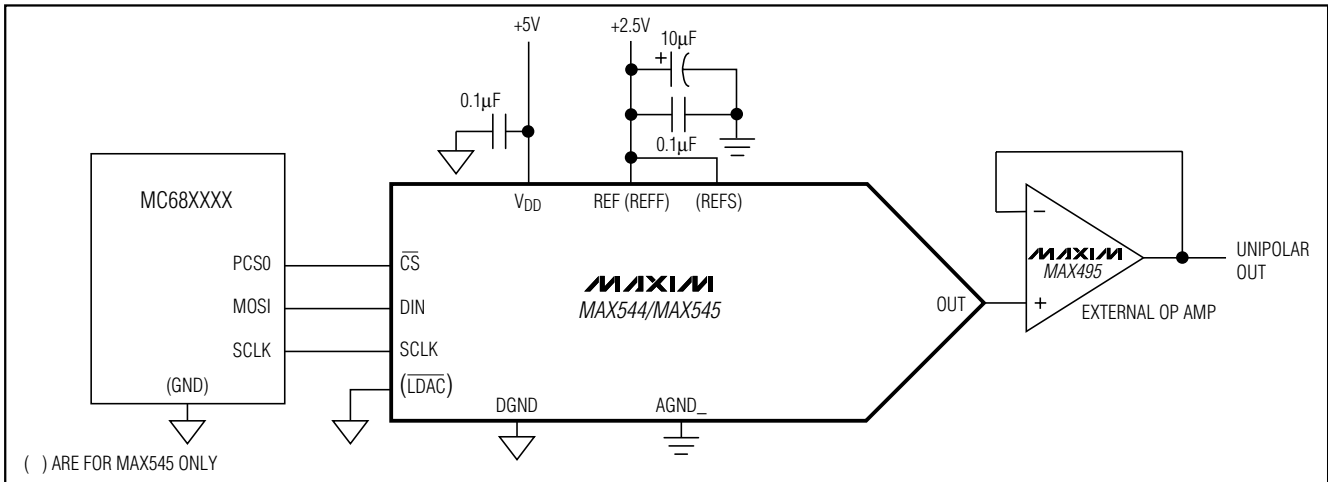

Figure 2a. Typical Operating Circuit—Unipolar Output

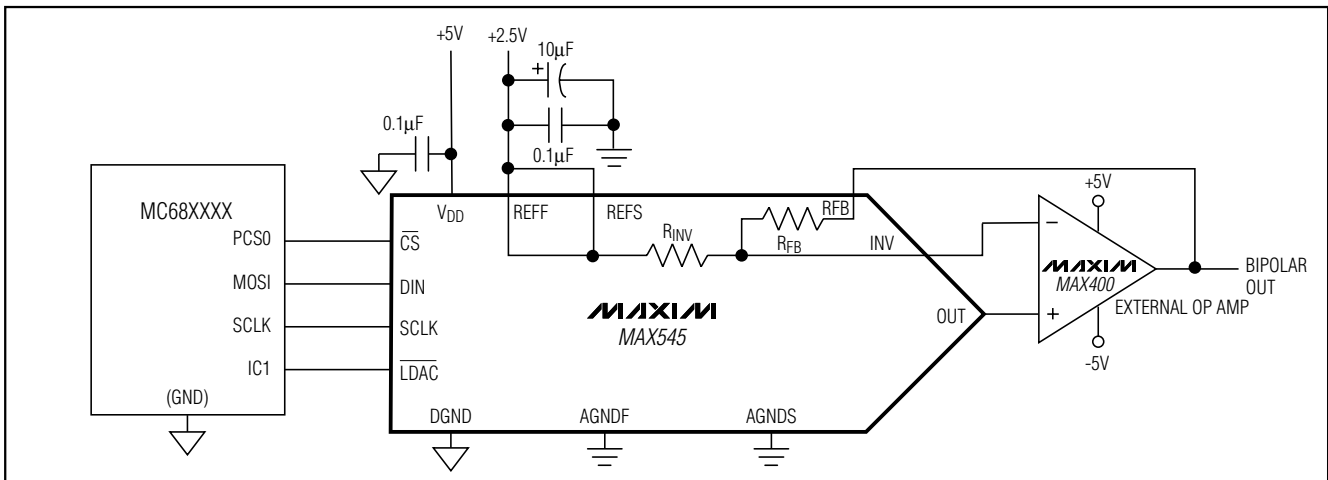

Figure 2b. Typical Operating Circuit—Bipolar Output

Detailed Description

The MAX544/MAX545 voltage-output, 14-bit digital-to-analog converters (DACs) offer full 14-bit performance with less than 0.5LSB integral linearity error and less than 0.9LSB differential linearity error, thus ensuring monotonic performance. Serial-data transfer minimizes the number of package pins required.

The MAX544/MAX545 are composed of two matched DAC sections, with an inverted R-2R DAC forming the LSBs and the four MSBs derived from 15 identically matched resistors. This architecture allows the lowest glitch energy to be transferred to the DAC output on

major-carry transitions. It also lowers the DAC output impedance by a factor of eight compared to a standard R-2R ladder, allowing unbuffered operation in medium-load applications.

The MAX545 provides matched bipolar offset resistors, which connect to an external op amp for bipolar output swings (Figure 2b). For optimum performance, the MAX545 also provides a set of Kelvin connections to the voltage-reference and analog-ground inputs.

+5V, Serial-Input, Voltage-Output, 14-Bit DACs

Digital Interface

The MAX544/MAX545's digital interface is a standard 3-wire connection compatible with SPI/QSPI/MICROWIRE interfaces. The chip-select input (\overline{CS}) frames the serial data loading at the data-input pin (DIN). Immediately following \overline{CS} 's high-to-low transition, the data is shifted synchronously and latched into the input register on the rising edge of the serial clock input (SCLK). After 16 bits (14 data bits, plus 2 sub-bits set to zero) have been loaded into the serial input register, it transfers its contents to the DAC latch on \overline{CS} 's low-to-high transition (Figure 3a). Note that if \overline{CS} is not kept low during the entire 16 SCLK cycles, data will be corrupted. In this case, reload the DAC latch with a new 16-bit word.

Alternatively, for the MAX545, \overline{LDAC} allows the DAC latch to update asynchronously by pulling \overline{LDAC} low after \overline{CS} goes high (Figure 3b). Hold \overline{LDAC} high during the data-loading sequence.

External Reference

The MAX544/MAX545 operate with external voltage references from 2V to 3V. The reference voltage determines the DAC's full-scale output voltage. Kelvin connections are provided with the MAX545 for optimum performance. The 2.5V MAX873A, with $\pm 15\text{mV}$ initial accuracy and a $7\text{ppm}/^\circ\text{C}$ (max) temperature coefficient, is a good choice.

Power-On Reset

The MAX544/MAX545 have a power-on reset circuit to set the DAC's output to 0V in unipolar mode when V_{DD} is first applied. This ensures that unwanted DAC output voltages will not occur immediately following a system power-up, such as after a loss of power. In bipolar mode, the DAC output is set to $-V_{REF}$.

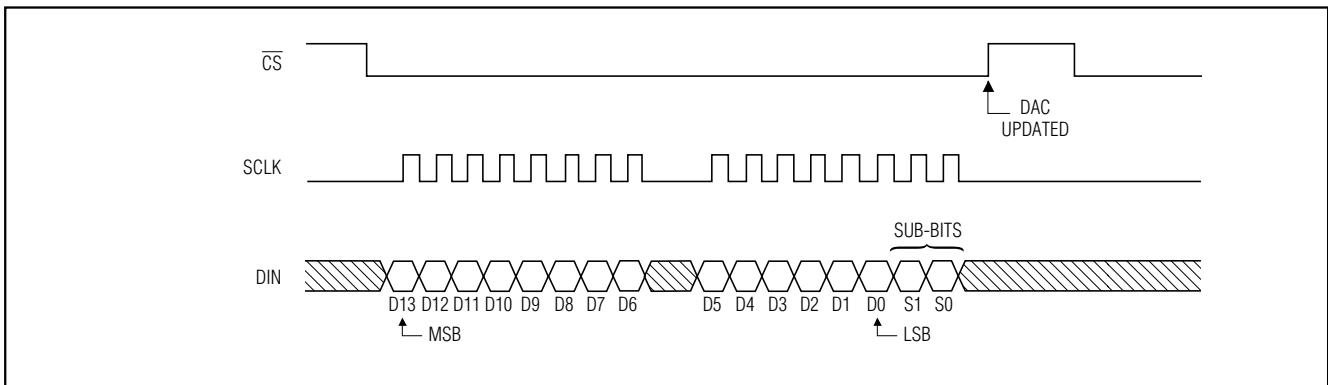

Figure 3a. MAX544/MAX545 3-Wire Interface Timing Diagram ($\overline{LDAC} = \text{DGND}$ for MAX545)

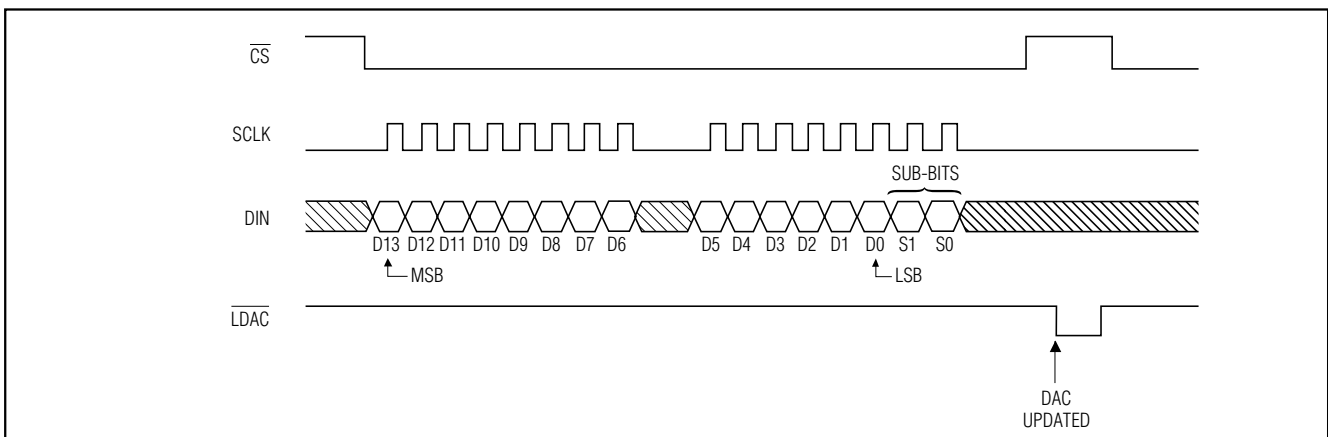

Figure 3b. MAX545 4-Wire Interface Timing Diagram

+5V, Serial-Input, Voltage-Output, 14-Bit DACs

Applications Information

Reference and Analog Ground Inputs

The MAX544/MAX545 operate with external voltage references from 2V to 3V, and maintain 14-bit performance if certain guidelines are followed when selecting and applying the reference. Ideally, the reference's temperature coefficient should be less than 1.5ppm/°C to maintain 14-bit accuracy to within 1LSB over the 0°C to +70°C commercial temperature range. Since this converter is designed as an inverted R-2R voltage-mode DAC, the input resistance seen by the voltage reference is code dependent. The worst-case input-resistance variation is from 11.5k Ω (at code 8554 hex) to 200k Ω (at code 0000 hex). The maximum change in load current for a +2.5V reference is $+2.5V / 11.5k\Omega = 217\mu A$; therefore, the required load regulation is 28ppm/mA for a maximum error of 0.1LSB. This implies a reference output impedance of less than 71m Ω . In addition, the signal-path impedance from the voltage reference to the reference input must be kept low because it contributes directly to the load-regulation error.

The requirement for a low-impedance voltage reference is met with capacitor bypassing at the reference inputs and ground. A 0.1 μF ceramic capacitor with short leads between REFF and AGNDF (MAX545), or REF and AGND (MAX544), provides high-frequency bypassing. A surface-mount ceramic chip capacitor is preferred because it has the lowest inductance. An additional 10 μF between REFF and AGNDF (MAX545), or REF and AGND (MAX544), provides low-frequency bypassing. A low-ESR tantalum, film, or organic semiconductor capacitor works well. Leaded capacitors are acceptable because impedance is not as critical at lower frequencies. The circuit can benefit from even larger bypassing capacitors, depending on the stability of the external reference with capacitive loading. If separate force and sense lines are not used, tie the appropriate force and sense pins together close to the package.

AGND must also be low impedance, as load-regulation errors will be introduced by excessive AGND resistance. As in all high-resolution, high-accuracy applications, separate analog and digital ground planes yield the best results. Tie DGND to AGND at the AGND pin to form the "star" ground for the DAC system. Always refer remote DAC loads to this system ground for the best possible performance.

Unbuffered Operation

Unbuffered operation reduces power consumption as well as offset error contributed by the external output buffer. The R-2R DAC output is available directly at OUT, allowing 14-bit performance from +VREF to AGND without degradation at zero scale. The DAC's output impedance is also low enough to drive medium loads ($R_L > 60k\Omega$) without degradation of INL or DNL; only the gain error is increased by externally loading the DAC output.

External Output Buffer Amplifier

The requirements on the external output buffer amplifier change whether the DAC is used in unipolar or bipolar operational mode. In unipolar mode, the output amplifier is used in a voltage-follower connection. In bipolar mode (MAX545 only), the amplifier operates with the internal scaling resistors (Figure 2b). In each mode, the DAC's output resistance is constant and is independent of input code; however, the output amplifier's input impedance should still be as high as possible to minimize gain errors. The DAC's output capacitance is also independent of input code, thus simplifying stability requirements on the external amplifier.

In bipolar mode, a precision amplifier operating with dual power supplies (such as the MAX400) provides the $\pm V_{REF}$ output range. In single-supply applications, precision amplifiers with input common-mode ranges including AGND are available; however, their output swings do not normally include the negative rail (AGND) without significant degradation of performance. A single-supply op amp, such as the MAX495, is suitable if the application does not use codes near zero.

Since the LSBs for a 14-bit DAC are extremely small (152.6 μV for $V_{REF} = 2.5V$), pay close attention to the external amplifier's input specification. The input offset voltage can degrade the zero-scale error and might require an output offset trim to maintain full accuracy if the offset voltage is greater than 1/2LSB. Similarly, the input bias current multiplied by the DAC output resistance (typically 6.25k Ω) contributes to zero-scale error. Temperature effects also must be taken into consideration. Over the 0°C to +70°C commercial temperature range, the offset voltage temperature coefficient (referenced to +25°C) must be less than 1.7 $\mu V/^\circ C$ to add less than 1/2LSB of zero-scale error. The external

+5V, Serial-Input, Voltage-Output, 14-Bit DACs

amplifier's input resistance forms a resistive divider with the DAC output resistance, which results in a gain error. To contribute less than 1/2LSB of gain error, the input resistance typically must be greater than:

$$6.25\text{k}\Omega \div \frac{1}{2} \left[\frac{1}{2^{14}} \right] = 205\text{M}\Omega$$

The settling time is affected by the buffer input capacitance, the DAC's output capacitance, and PC board capacitance. The typical DAC output voltage settling time is 1 μ s for a full-scale step. Settling time can be significantly less for smaller step changes. Assuming a single time-constant exponential settling response, a full-scale step takes 10.4 time constants to settle to within 1/2LSB of the final output voltage. The time constant is equal to the DAC output resistance multiplied by the total output capacitance. The DAC output capacitance is typically 10pF. Any additional output capacitance increases the settling time.

The external buffer amplifier's gain-bandwidth product is important because it increases the settling time by adding another time constant to the output response. The effective time constant of two cascaded systems, each with a single time-constant response, is approximately the root square sum of the two time constants. The DAC output's time constant is 1 μ s / 10.4 = 96ns, ignoring the effect of additional capacitance. If the time constant of an external amplifier with 1MHz bandwidth is 1 / 2 π (1MHz) = 159ns, then the effective time constant of the combined system is:

$$\sqrt{[(96\text{ns})^2 + (159\text{ns})^2]} = 186\text{ns}$$

This suggests that the settling time to within 1/2LSB of the final output voltage, including the external buffer amplifier, will be approximately 10.4 • 186ns = 1.93 μ s.

Digital Inputs and Interface Logic

The digital interface for the 14-bit DAC is based on a 3-wire standard that is compatible with SPI, QSPI, and MICROWIRE interfaces. The three digital inputs ($\overline{\text{CS}}$, DIN, and SCLK) load the digital input data serially into the DAC. LDAC (MAX545) updates the DAC output asynchronously.

All of the digital inputs include Schmitt-trigger buffers to accept slow-transition interfaces. This means that optocouplers can interface directly to the MAX544/MAX545 without additional external logic. The digital inputs are compatible with TTL/CMOS-logic levels.

Unipolar Configuration

Figure 2a shows the MAX544/MAX545 configured for unipolar operation with an external op amp. The op amp is set for unity gain, and Table 1 lists the codes for this circuit.

Bipolar Configuration

Figure 2b shows the MAX545 configured for bipolar operation with an external op amp. The op amp is set for unity gain with an offset of -1/2V_{REF}. Table 2 shows the offset binary codes for this circuit.

Power-Supply Bypassing and Ground Management

For optimum system performance, use PC boards with separate analog and digital ground planes. Wire-wrap boards are not recommended. Connect the two ground planes together at the low-impedance power-supply source. Connect DGND and AGND together at the IC. The best ground connection can be achieved by connecting the DAC's DGND and AGND pins together and connecting that point to the system analog ground plane. If the DAC's DGND is connected to the system digital ground, digital noise may get through to the DAC's analog portion.

Bypass V_{DD} with a 0.1 μ F ceramic capacitor connected between V_{DD} and AGND. Mount it with short leads close to the device. Ferrite beads can also be used to further isolate the analog and digital power supplies.

Table 1. Unipolar Code Table

DAC LATCH CONTENTS		ANALOG OUTPUT, V _{OUT}
MSB	LSB	
1111 1111 1111 11(00)		V _{REF} • (16,383 / 16,384)
1000 0000 0000 00(00)		V _{REF} • (8192 / 16,384) = 1/2V _{REF}
0000 0000 0000 01(00)		V _{REF} • (1 / 16,384)
0000 0000 0000 00(00)		0V

Table 2. Bipolar Code Table

DAC LATCH CONTENTS		ANALOG OUTPUT, V _{OUT}
MSB	LSB	
1111 1111 1111 11(00)		+V _{REF} • (8191 / 8192)
1000 0000 0000 01(00)		+V _{REF} • (1 / 8192)
1000 0000 0000 00(00)		0V
0111 1111 1111 11(00)		-V _{REF} • (1 / 8192)
0000 0000 0000 00(00)		-V _{REF} • (8192 / 8192) = -V _{REF}

() = Sub-bits

+5V, Serial-Input, Voltage-Output, 14-Bit DACs

MAX544/MAX545

Ordering Information (continued)

PART	TEMP. RANGE	PIN-PACKAGE	INL (LSB)
MAX544AEPA	-40°C to +85°C	8 Plastic DIP	±1/2
MAX544BEPA	-40°C to +85°C	8 Plastic DIP	±1
MAX544AESA	-40°C to +85°C	8 SO	±1/2
MAX544BESA	-40°C to +85°C	8 SO	±1
MAX545 ACPD	0°C to +70°C	14 Plastic DIP	±1/2
MAX545BCPD	0°C to +70°C	14 Plastic DIP	±1
MAX545ACSD	0°C to +70°C	14 SO	±1/2
MAX545BCSD	0°C to +70°C	14 SO	±1
MAX545AEPD	-40°C to +85°C	14 Plastic DIP	±1/2
MAX545BEPD	-40°C to +85°C	14 Plastic DIP	±1
MAX545AESD	-40°C to +85°C	14 SO	±1/2
MAX545BESD	-40°C to +85°C	14 SO	±1
MAX545BMJD	-55°C to +125°C	14 Ceramic SB*	±1

*Contact factory for availability.

Functional Diagrams (continued)

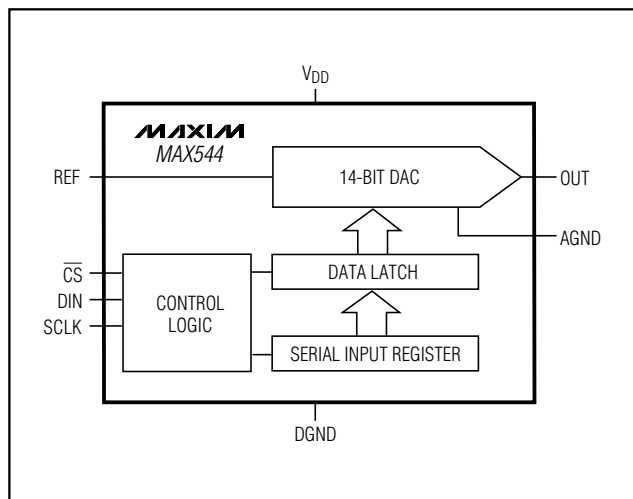

Chip Information

TRANSISTOR COUNT: 2209

+5V, Serial-Input, Voltage-Output, 14-Bit DACs

Package Information

	INCHES		MILLIMETERS	
	MIN	MAX	MIN	MAX
A	0.053	0.069	1.35	1.75
A1	0.004	0.010	0.10	0.25
B	0.014	0.019	0.35	0.49
C	0.007	0.010	0.19	0.25
e	0.050		1.27	
E	0.150	0.157	3.80	4.00
H	0.228	0.244	5.80	6.20
h	0.010	0.020	0.25	0.50
L	0.016	0.050	0.40	1.27

	INCHES		MILLIMETERS		N	MS012
	MIN	MAX	MIN	MAX		
D	0.189	0.197	4.80	5.00	8	A
D	0.337	0.344	8.55	8.75	14	B
D	0.386	0.394	9.80	10.00	16	C

NOTES:
 1. DAE DO NOT INCLUDE MOLD FLASH
 2. MOLD FLASH OR PROTRUSIONS NOT TO EXCEED .15mm (.006")
 3. LEADS TO BE COPLANAR WITHIN .02mm (.004")
 4. CONTROLLING DIMENSION: MILLIMETER
 5. MEETS JEDEC MS012-XX AS SHOWN IN ABOVE TABLE
 6. N = NUMBER OF PINS

MAXIM PACKAGE FAMILY OUTLINE: SOIC .150° 1/1 21-0041 A
MAXIM INTEGRATED PRODUCTS, INC. 120 SAN GABRIEL DRIVE, SUNNYVALE, CA 94086-6099

	INCHES		MILLIMETERS	
	MIN	MAX	MIN	MAX
A	---	0.180	---	4.572
A1	0.020	---	0.508	---
A2	0.125	0.175	3.18	4.45
A3	0.055	0.080	1.40	2.03
B	0.015	0.021	0.381	0.533
B1	0.045	0.060	1.14	1.524
C	0.009	0.014	0.229	0.355
D1	0.005	0.080	0.13	2.03
E	0.300	0.325	7.62	8.255
E1	0.275	0.295	6.985	7.493
e	0.100	---	2.54	---
eA	0.300	---	7.62	---
eB	---	0.400	---	10.16
L	0.115	0.150	2.921	3.81

	INCHES		MILLIMETERS		N	MS001
	MIN	MAX	MIN	MAX		
D	0.348	0.390	8.84	9.91	8	AB
D	0.735	0.765	18.67	19.43	14	AC
D	0.745	0.765	18.92	19.43	16	AA
D	0.885	0.915	22.48	23.24	18	AD
D	1.015	1.045	25.78	26.54	20	AE
D	1.14	1.265	28.96	32.13	24	AF
D	1.360	1.380	34.54	35.05	28	*5

NOTES:
 1. DAE DO NOT INCLUDE MOLD FLASH
 2. MOLD FLASH OR PROTRUSIONS NOT TO EXCEED .15mm (.006")
 3. CONTROLLING DIMENSION: MILLIMETER
 4. MEETS JEDEC MS001-XX AS SHOWN IN ABOVE TABLE
 5. SIMILAR TO JEDEC MS-095-AH
 6. N = NUMBER OF PINS

MAXIM PACKAGE FAMILY OUTLINE: PDIP .300° 1/1 21-0043 B
MAXIM INTEGRATED PRODUCTS, INC. 120 SAN GABRIEL DRIVE, SUNNYVALE, CA 94086-6099

Maxim cannot assume responsibility for use of any circuitry other than circuitry entirely embodied in a Maxim product. No circuit patent licenses are implied. Maxim reserves the right to change the circuitry and specifications without notice at any time.

12 **Maxim Integrated Products, 120 San Gabriel Drive, Sunnyvale, CA 94086 408-737-7600**



Стандарт Электрон Связь

Мы молодая и активно развивающаяся компания в области поставок электронных компонентов. Мы поставляем электронные компоненты отечественного и импортного производства напрямую от производителей и с крупнейших складов мира.

Благодаря сотрудничеству с мировыми поставщиками мы осуществляем комплексные и плановые поставки широчайшего спектра электронных компонентов.

Собственная эффективная логистика и склад в обеспечивает надежную поставку продукции в точно указанные сроки по всей России.

Мы осуществляем техническую поддержку нашим клиентам и предпродажную проверку качества продукции. На все поставляемые продукты мы предоставляем гарантию .

Осуществляем поставки продукции под контролем ВП МО РФ на предприятия военно-промышленного комплекса России , а также работаем в рамках 275 ФЗ с открытием отдельных счетов в уполномоченном банке. Система менеджмента качества компании соответствует требованиям ГОСТ ISO 9001.

Минимальные сроки поставки, гибкие цены, неограниченный ассортимент и индивидуальный подход к клиентам являются основой для выстраивания долгосрочного и эффективного сотрудничества с предприятиями радиоэлектронной промышленности, предприятиями ВПК и научно-исследовательскими институтами России.

С нами вы становитесь еще успешнее!

Наши контакты:

Телефон: +7 812 627 14 35

Электронная почта: sales@st-electron.ru

Адрес: 198099, Санкт-Петербург,
Промышленная ул, дом № 19, литера Н,
помещение 100-Н Офис 331