

BCP55; BCX55; BC55PA

60 V, 1 A NPN medium power transistors

Rev. 8 — 24 October 2011

Product data sheet

1. Product profile

1.1 General description

NPN medium power transistor series in Surface-Mounted Device (SMD) plastic packages.

Table 1. Product overview

Type number ^[1]	Package			PNP complement
	NXP	JEITA	JEDEC	
BCP55	SOT223	SC-73	-	BCP52
BCX55	SOT89	SC-62	TO-243	BCX52
BC55PA	SOT1061	-	-	BC52PA

[1] Valid for all available selection groups.

1.2 Features and benefits

- High current
- Three current gain selections
- High power dissipation capability
- Exposed heatsink for excellent thermal and electrical conductivity (SOT89, SOT1061)
- Leadless very small SMD plastic package with medium power capability (SOT1061)
- AEC-Q101 qualified

1.3 Applications

- Linear voltage regulators
- Low-side switches
- Battery-driven devices
- Power management
- MOSFET drivers
- Amplifiers

1.4 Quick reference data

Table 2. Quick reference data

Symbol	Parameter	Conditions	Min	Typ	Max	Unit
V_{CE0}	collector-emitter voltage	open base	-	-	60	V
I_C	collector current		-	-	1	A
I_{CM}	peak collector current	single pulse; $t_p \leq 1$ ms	-	-	2	A
h_{FE}	DC current gain	$V_{CE} = 2$ V; $I_C = 150$ mA	[1] 63	-	250	
	h_{FE} selection -10	$V_{CE} = 2$ V; $I_C = 150$ mA	[1] 63	-	160	
	h_{FE} selection -16	$V_{CE} = 2$ V; $I_C = 150$ mA	[1] 100	-	250	

[1] Pulse test: $t_p \leq 300$ μ s; $\delta = 0.02$.



2. Pinning information

Table 3. Pinning

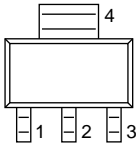
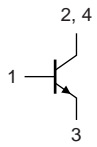
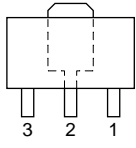
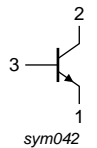
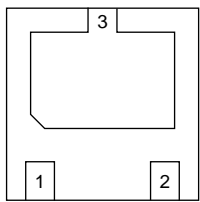
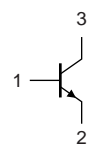
Pin	Description	Simplified outline	Graphic symbol
SOT223			
1	base		
2	collector		
3	emitter		
4	collector		
SOT89			
1	emitter		
2	collector		
3	base		
SOT1061			
1	base	 <p>Transparent top view</p>	
2	emitter		
3	collector		

3. Ordering information

Table 4. Ordering information

Type number ^[1]	Package		Version
	Name	Description	
BCP55	SC-73	plastic surface-mounted package with increased heatsink; 4 leads	SOT223
BCX55	SC-62	plastic surface-mounted package; exposed die pad for good heat transfer; 3 leads	SOT89
BC55PA	HUSON3	plastic thermal enhanced ultra thin small outline package; no leads; 3 terminals; body 2 × 2 × 0.65 mm	SOT1061

[1] Valid for all available selection groups.

4. Marking

Table 5. Marking codes

Type number	Marking code
BCP55	BCP55
BCP55-10	BCP55/10
BCP55-16	BCP55/16
BCX55	BE
BCX55-10	BG
BCX55-16	BM
BC55PA	AW
BC55-10PA	BH
BC55-16PA	BJ

5. Limiting values

Table 6. Limiting values

In accordance with the Absolute Maximum Rating System (IEC 60134).

Symbol	Parameter	Conditions	Min	Max	Unit			
V_{CBO}	collector-base voltage	open emitter	-	60	V			
V_{CEO}	collector-emitter voltage	open base	-	60	V			
V_{EBO}	emitter-base voltage	open collector	-	5	V			
I_C	collector current		-	1	A			
I_{CM}	peak collector current	single pulse; $t_p \leq 1$ ms	-	2	A			
I_B	base current		-	0.3	A			
I_{BM}	peak base current	single pulse; $t_p \leq 1$ ms	-	0.3	A			
P_{tot}	total power dissipation	$T_{amb} \leq 25$ °C						
			BCP55	[1]	-	0.65	W	
				[2]	-	1.00	W	
				[3]	-	1.35	W	
			BCX55	[1]	-	0.50	W	
				[2]	-	0.95	W	
				[3]	-	1.35	W	
			BC55PA	[1]	-	0.42	W	
				[2]	-	0.83	W	
				[3]	-	1.10	W	
				[4]	-	0.81	W	
				[5]	-	1.65	W	
			T_j	junction temperature		-	150	°C
			T_{amb}	ambient temperature		-55	+150	°C
			T_{stg}	storage temperature		-65	+150	°C

[1] Device mounted on an FR4 Printed-Circuit Board (PCB), single-sided copper, tin-plated and standard footprint.

[2] Device mounted on an FR4 PCB, single-sided copper, tin-plated, mounting pad for collector 1 cm².

[3] Device mounted on an FR4 PCB, single-sided copper, tin-plated, mounting pad for collector 6 cm².

[4] Device mounted on an FR4 PCB, 4-layer copper, tin-plated and standard footprint.

[5] Device mounted on an FR4 PCB, 4-layer copper, tin-plated, mounting pad for collector 1 cm².

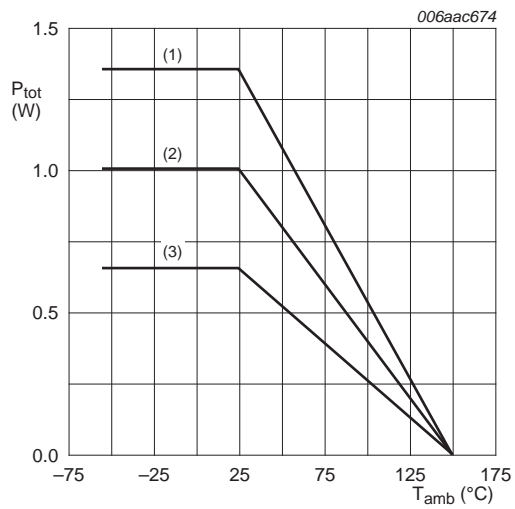

- (1) FR4 PCB, mounting pad for collector 6 cm²
- (2) FR4 PCB, mounting pad for collector 1 cm²
- (3) FR4 PCB, standard footprint

Fig 1. Power derating curves SOT223

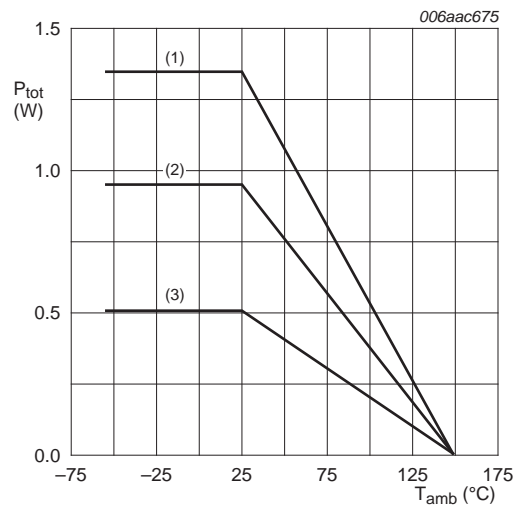

- (1) FR4 PCB, mounting pad for collector 6 cm²
- (2) FR4 PCB, mounting pad for collector 1 cm²
- (3) FR4 PCB, standard footprint

Fig 2. Power derating curves SOT89

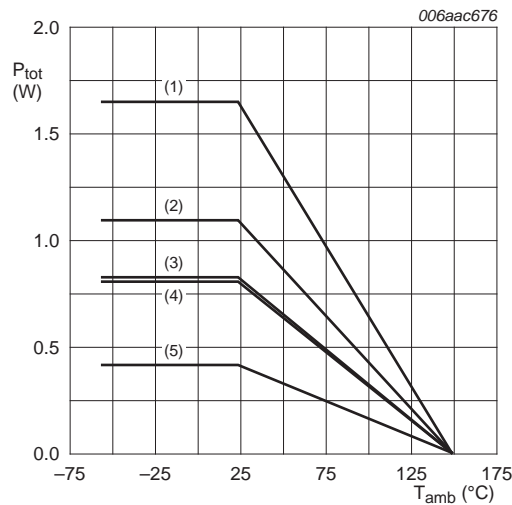

- (1) FR4 PCB, 4-layer copper, mounting pad for collector 1 cm²
- (2) FR4 PCB, single-sided copper, mounting pad for collector 6 cm²
- (3) FR4 PCB, single-sided copper, mounting pad for collector 1 cm²
- (4) FR4 PCB, 4-layer copper, standard footprint
- (5) FR4 PCB, single-sided copper, standard footprint

Fig 3. Power derating curves SOT1061

6. Thermal characteristics

Table 7. Thermal characteristics

Symbol	Parameter	Conditions	Min	Typ	Max	Unit		
$R_{th(j-a)}$	thermal resistance from junction to ambient	in free air						
			BCP55	[1]	-	-	192	K/W
				[2]	-	-	125	K/W
				[3]	-	-	93	K/W
			BCX55	[1]	-	-	250	K/W
				[2]	-	-	132	K/W
				[3]	-	-	93	K/W
			BC55PA	[1]	-	-	298	K/W
				[2]	-	-	151	K/W
	[3]	-		-	114	K/W		
	[4]	-		-	154	K/W		
	[5]	-		-	76	K/W		
	$R_{th(j-sp)}$	thermal resistance from junction to solder point						
			BCP55	-	-	16	K/W	
			BCX55	-	-	16	K/W	
BC55PA			-	-	20	K/W		

[1] Device mounted on an FR4 PCB, single-sided copper, tin-plated and standard footprint.

[2] Device mounted on an FR4 PCB, single-sided copper, tin-plated, mounting pad for collector 1 cm².

[3] Device mounted on an FR4 PCB, single-sided copper, tin-plated, mounting pad for collector 6 cm².

[4] Device mounted on an FR4 PCB, 4-layer copper, tin-plated and standard footprint.

[5] Device mounted on an FR4 PCB, 4-layer copper, tin-plated, mounting pad for collector 1 cm².

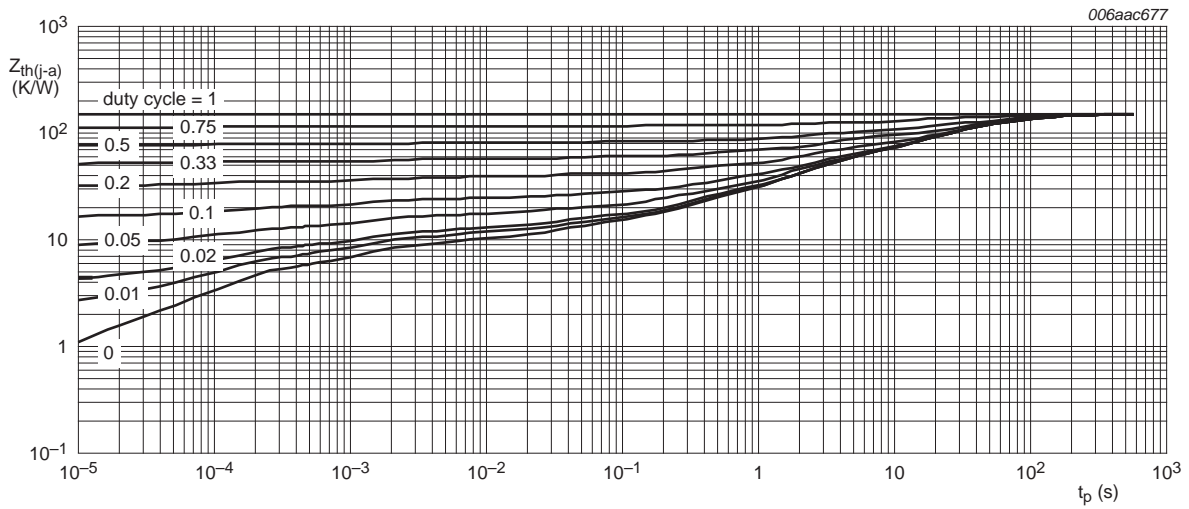

Fig 4. Transient thermal impedance from junction to ambient as a function of pulse duration for SOT223; typical values

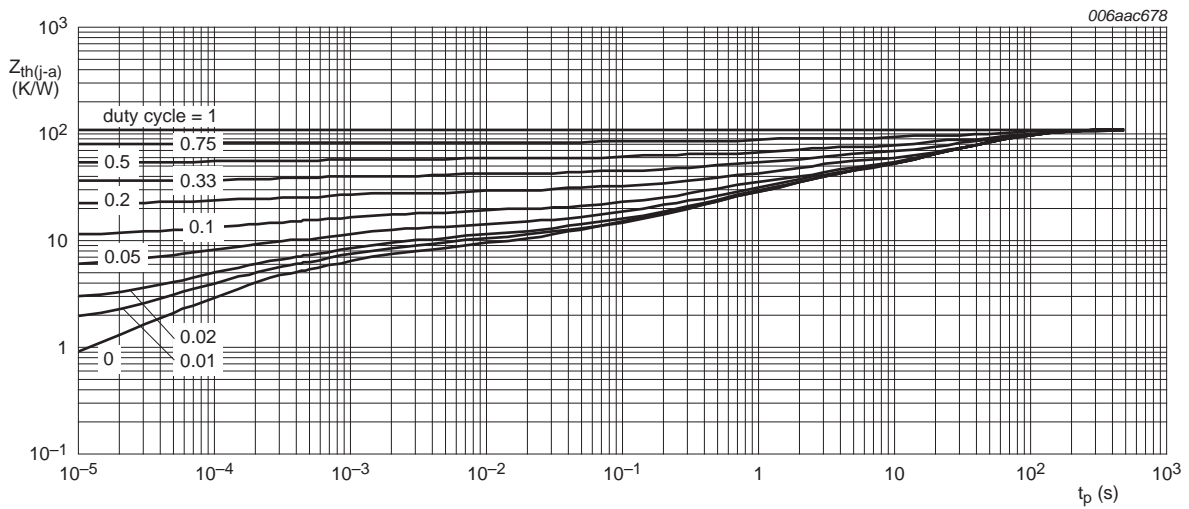
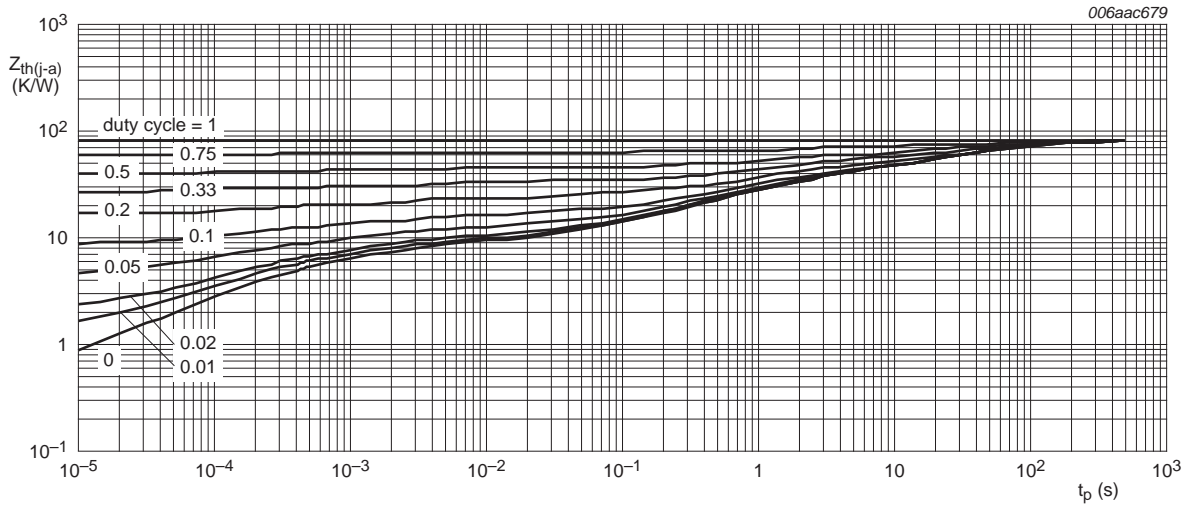
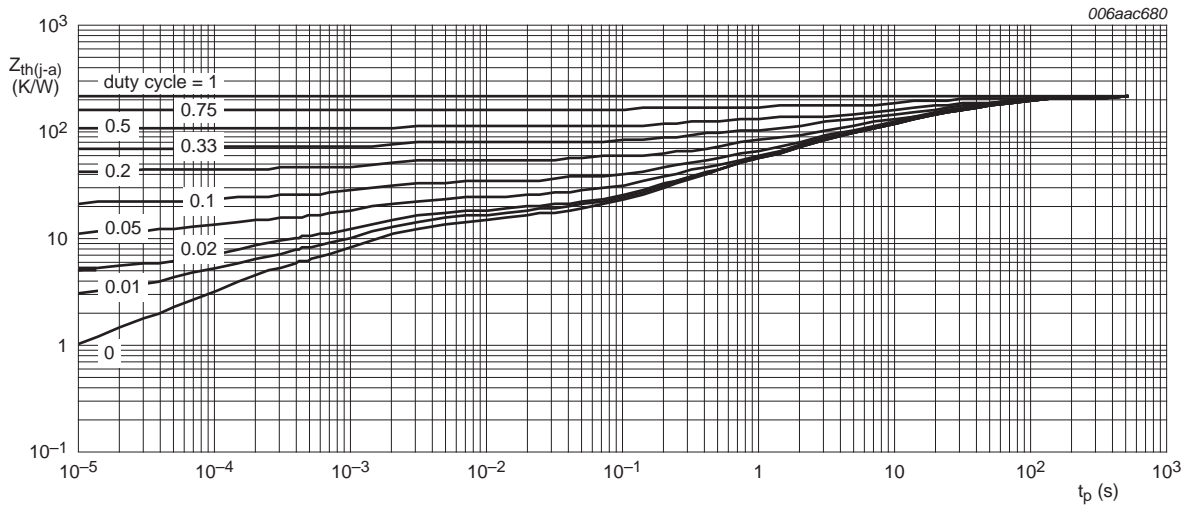

Fig 5. Transient thermal impedance from junction to ambient as a function of pulse duration for SOT223; typical values



FR4 PCB, mounting pad for collector 6 cm²

Fig 6. Transient thermal impedance from junction to ambient as a function of pulse duration for SOT223; typical values



FR4 PCB, standard footprint

Fig 7. Transient thermal impedance from junction to ambient as a function of pulse duration for SOT89; typical values

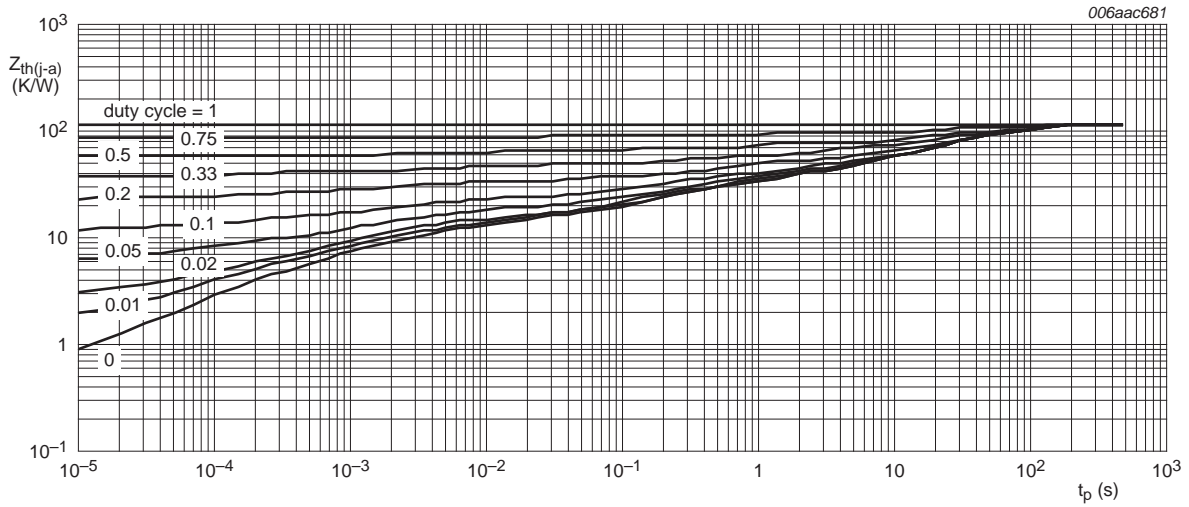

FR4 PCB, mounting pad for collector 1 cm²

Fig 8. Transient thermal impedance from junction to ambient as a function of pulse duration for SOT89; typical values

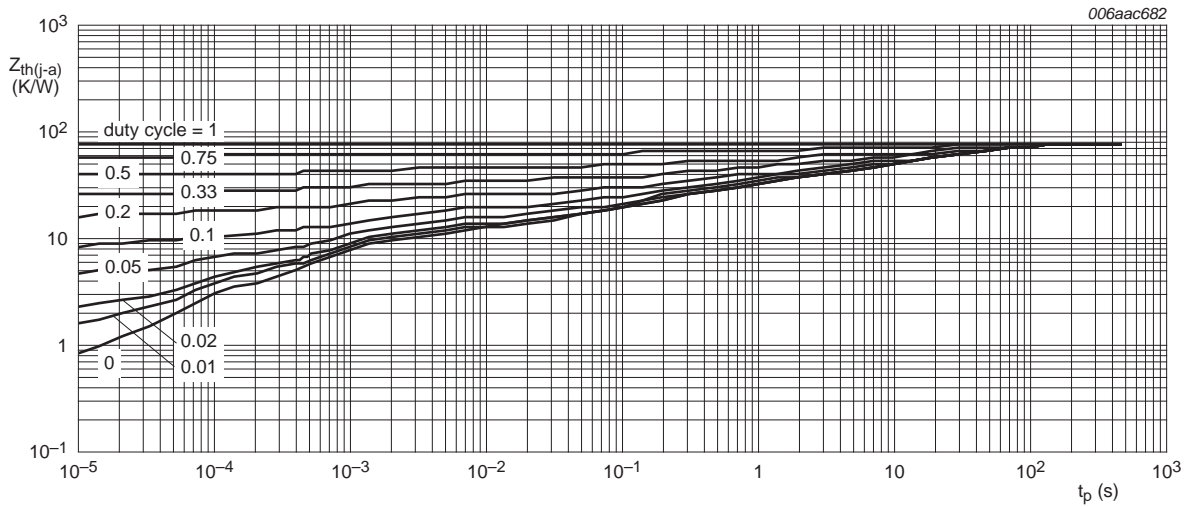

FR4 PCB, mounting pad for collector 6 cm²

Fig 9. Transient thermal impedance from junction to ambient as a function of pulse duration for SOT89; typical values

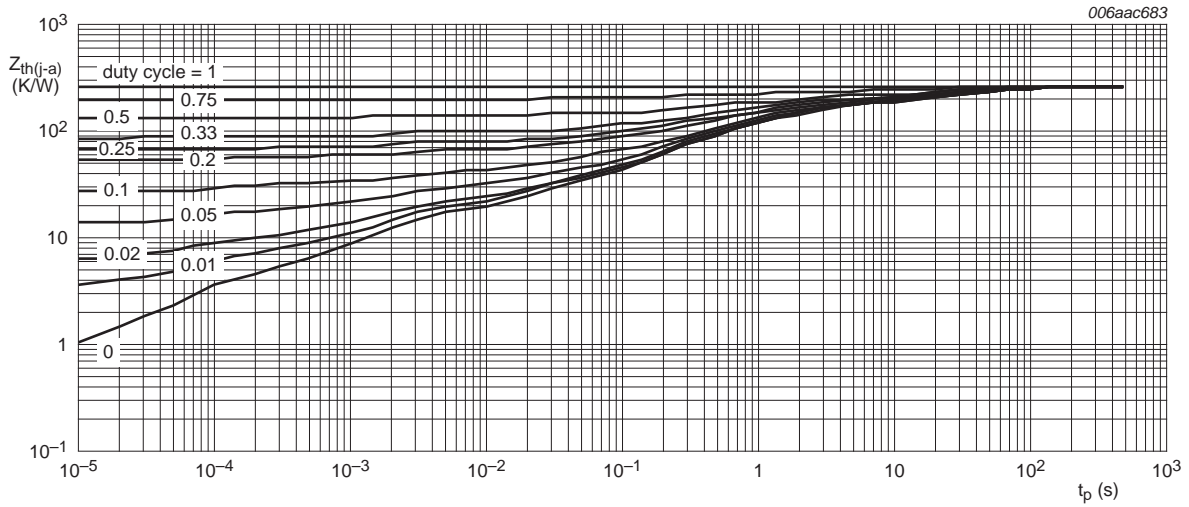

FR4 PCB, single-sided copper, standard footprint

Fig 10. Transient thermal impedance from junction to ambient as a function of pulse duration for SOT1061; typical values

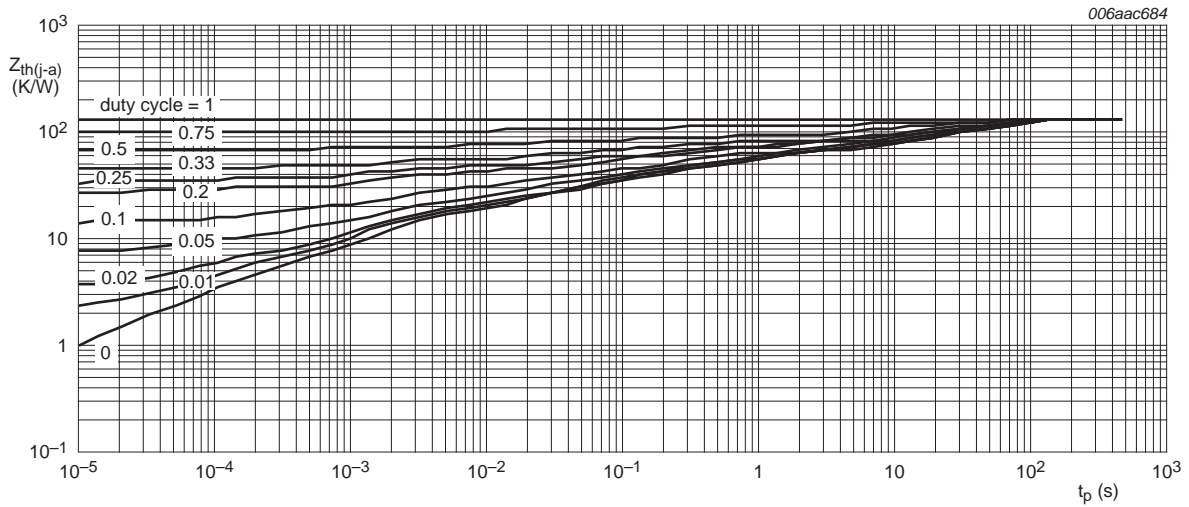

FR4 PCB, single-sided copper, mounting pad for collector 1 cm²

Fig 11. Transient thermal impedance from junction to ambient as a function of pulse duration for SOT1061; typical values

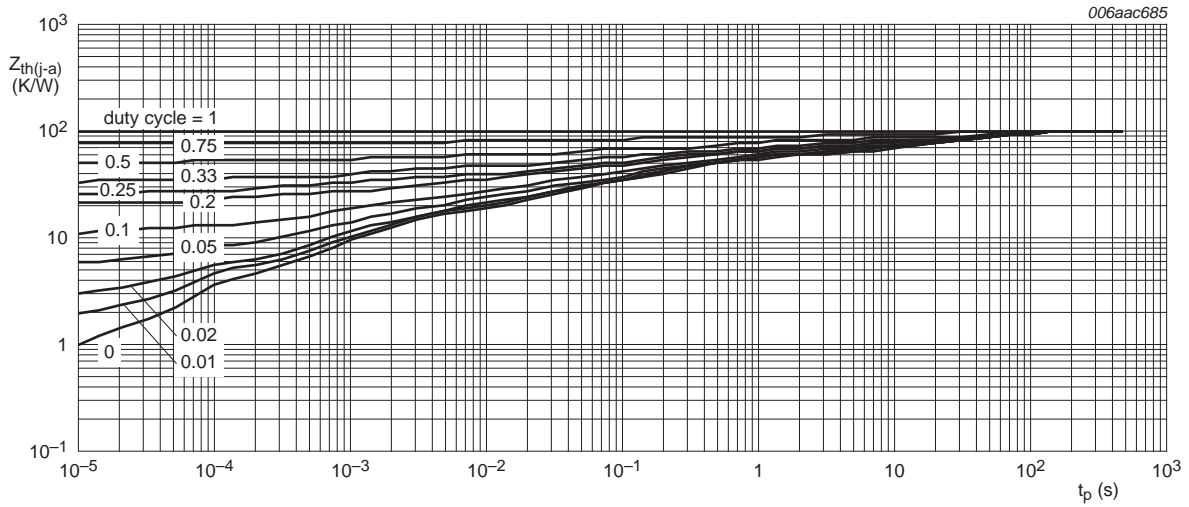

Fig 12. Transient thermal impedance from junction to ambient as a function of pulse duration for SOT1061; typical values

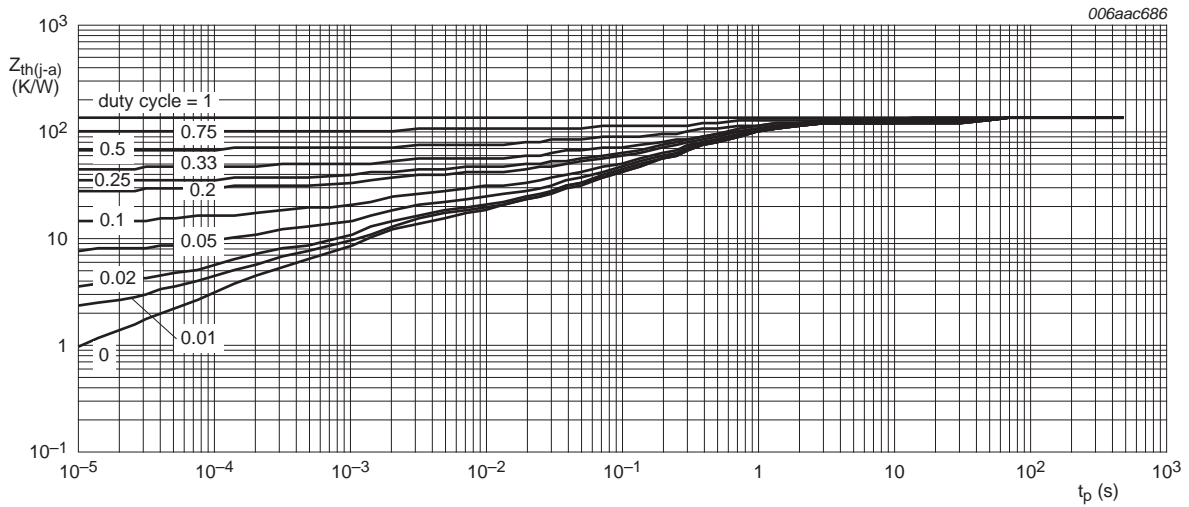
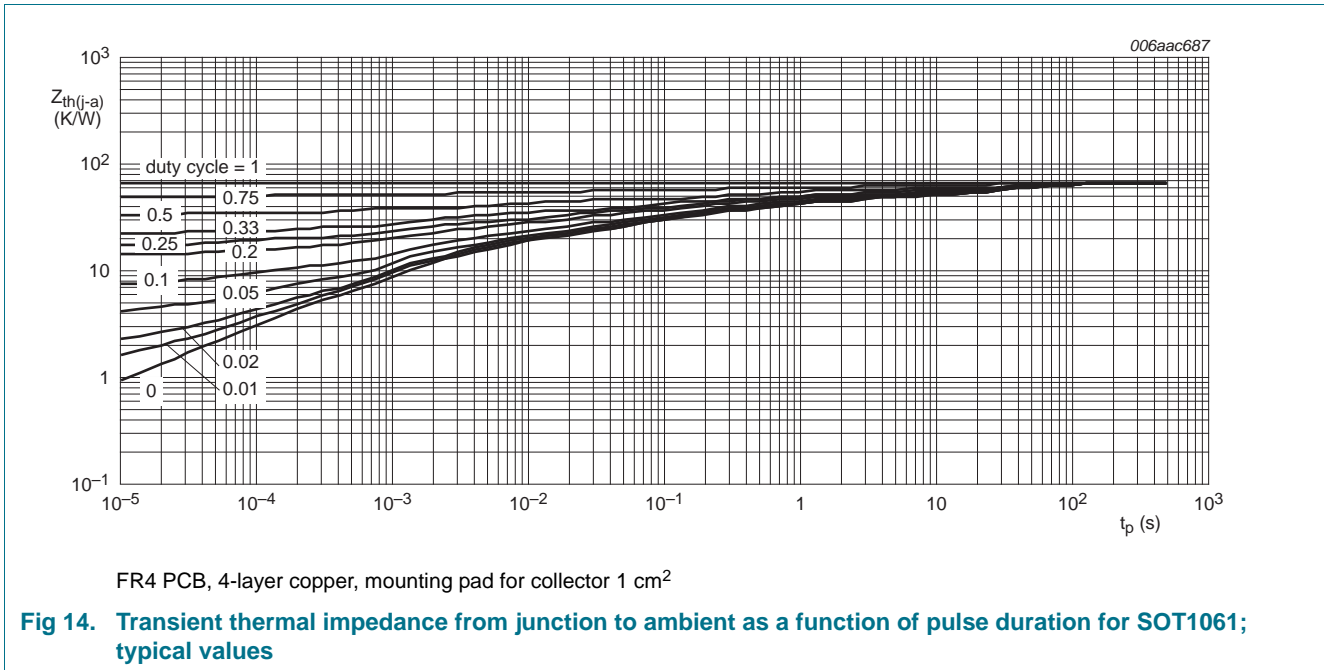

Fig 13. Transient thermal impedance from junction to ambient as a function of pulse duration for SOT1061; typical values



7. Characteristics

Table 8. Characteristics

T_{amb} = 25 °C unless otherwise specified.

Symbol	Parameter	Conditions	Min	Typ	Max	Unit
I _{CBO}	collector-base cut-off current	V _{CB} = 30 V; I _E = 0 A	-	-	100	nA
		V _{CB} = 30 V; I _E = 0 A; T _j = 150 °C	-	-	10	μA
I _{EBO}	emitter-base cut-off current	V _{EB} = 5 V; I _C = 0 A	-	-	100	nA
h _{FE}	DC current gain	V _{CE} = 2 V				
		I _C = 5 mA	[1] 63	-	-	
		I _C = 150 mA	[1] 63	-	250	
	I _C = 500 mA	[1] 40	-	-		
	DC current gain	V _{CE} = 2 V				
h _{FE} selection -10		I _C = 150 mA	[1] 63	-	160	
h _{FE} selection -16		I _C = 150 mA	[1] 100	-	250	
V _{CEsat}	collector-emitter saturation voltage	I _C = 500 mA; I _B = 50 mA	[1] -	-	0.5	V
V _{BE}	base-emitter voltage	V _{CE} = 2 V; I _C = 500 mA	[1] -	-	1	V
C _C	collector capacitance	V _{CB} = 10 V; I _E = I _e = 0 A; f = 1 MHz	-	6	-	pF
f _T	transition frequency	V _{CE} = 5 V; I _C = 50 mA; f = 100 MHz	100	180	-	MHz

[1] Pulse test: t_p ≤ 300 μs; δ = 0.02.

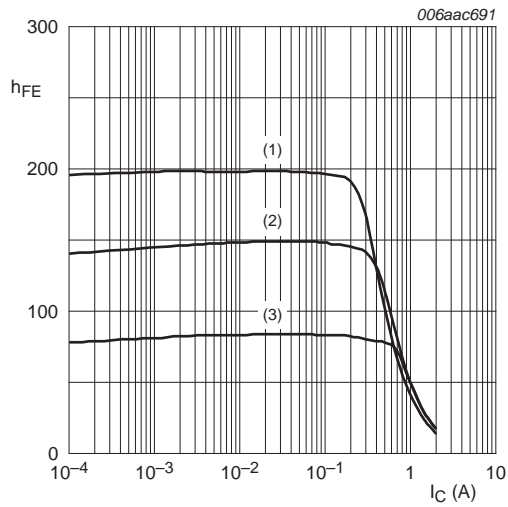

$V_{CE} = 2\text{ V}$
 (1) $T_{amb} = 100\text{ }^{\circ}\text{C}$
 (2) $T_{amb} = 25\text{ }^{\circ}\text{C}$
 (3) $T_{amb} = -55\text{ }^{\circ}\text{C}$

Fig 15. DC current gain as a function of collector current; typical values

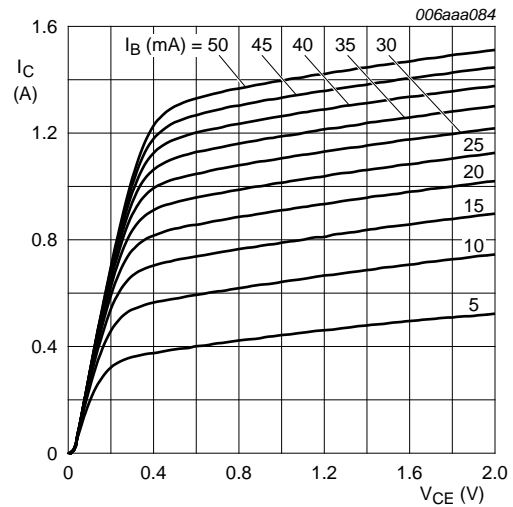

$T_{amb} = 25\text{ }^{\circ}\text{C}$

Fig 16. Collector current as a function of collector-emitter voltage; typical values

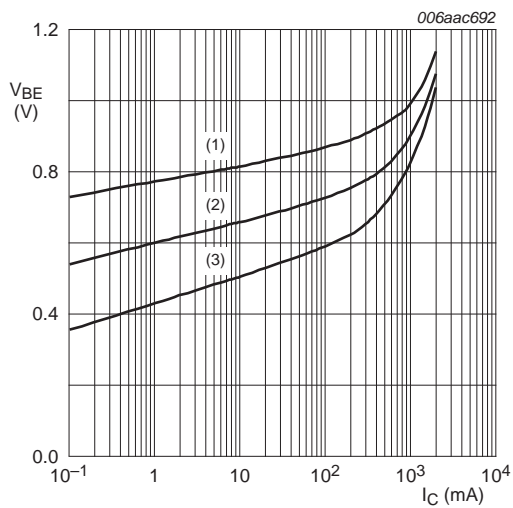

$V_{CE} = 2\text{ V}$
 (1) $T_{amb} = -55\text{ }^{\circ}\text{C}$
 (2) $T_{amb} = 25\text{ }^{\circ}\text{C}$
 (3) $T_{amb} = 100\text{ }^{\circ}\text{C}$

Fig 17. Base-emitter voltage as a function of collector current; typical values

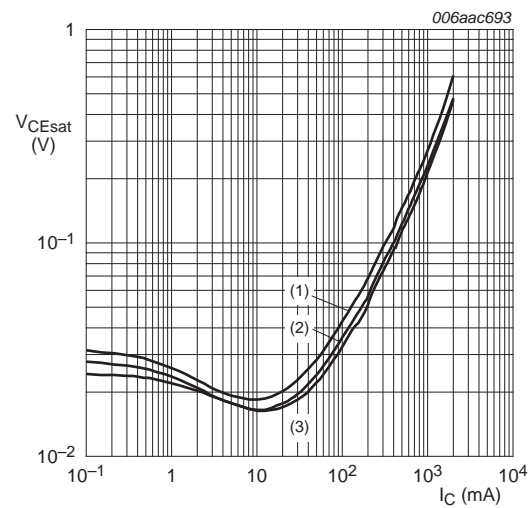

$I_C/I_B = 10$
 (1) $T_{amb} = 100\text{ }^{\circ}\text{C}$
 (2) $T_{amb} = 25\text{ }^{\circ}\text{C}$
 (3) $T_{amb} = -55\text{ }^{\circ}\text{C}$

Fig 18. Collector-emitter saturation voltage as a function of collector current; typical values

8. Test information

8.1 Quality information

This product has been qualified in accordance with the Automotive Electronics Council (AEC) standard *Q101 - Stress test qualification for discrete semiconductors*, and is suitable for use in automotive applications.

9. Package outline

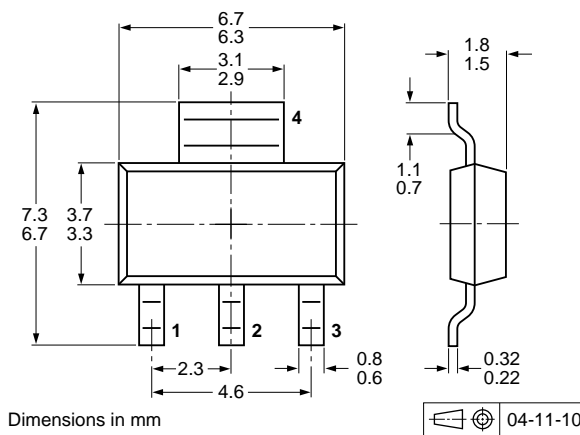

Fig 19. Package outline SOT223 (SC-73)

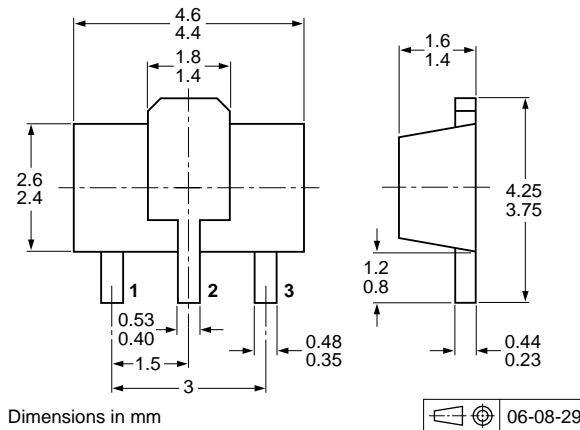
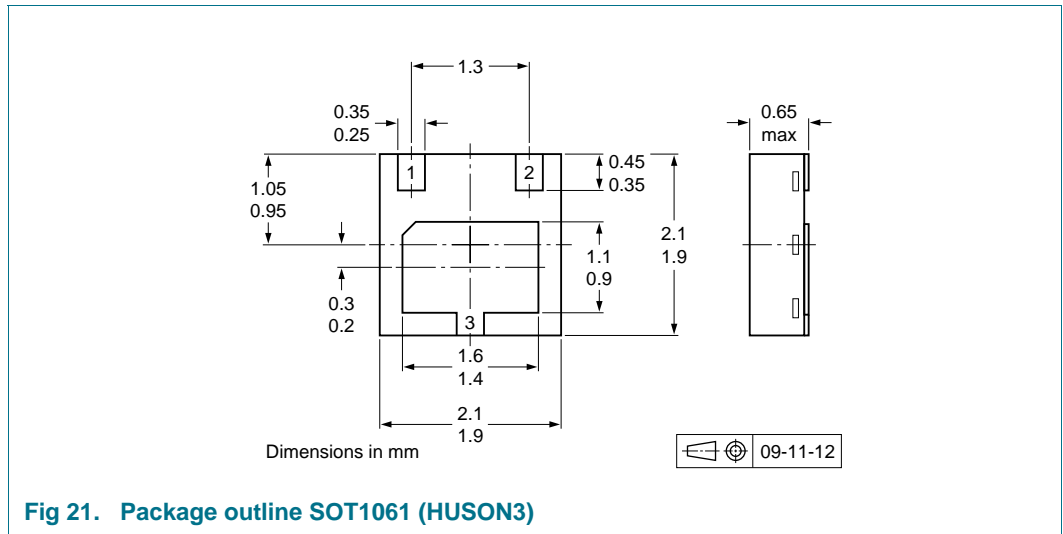

Fig 20. Package outline SOT89 (SC-62/TO-243)



10. Packing information

Table 9. Packing methods

The indicated -xxx are the last three digits of the 12NC ordering code.^[1]

Type number ^[2]	Package	Description	Packing quantity		
			1000	3000	4000
BCP55	SOT223	8 mm pitch, 12 mm tape and reel	-115	-	-135
BCX55	SOT89	8 mm pitch, 12 mm tape and reel; T1 ^[3]	-115	-	-135
		8 mm pitch, 12 mm tape and reel; T3 ^[4]	-146	-	-
BC55PA	SOT1061	4 mm pitch, 8 mm tape and reel	-	-115	-

[1] For further information and the availability of packing methods, see [Section 14](#).

[2] Valid for all available selection groups.

[3] T1: normal taping

[4] T3: 90° rotated taping

11. Soldering

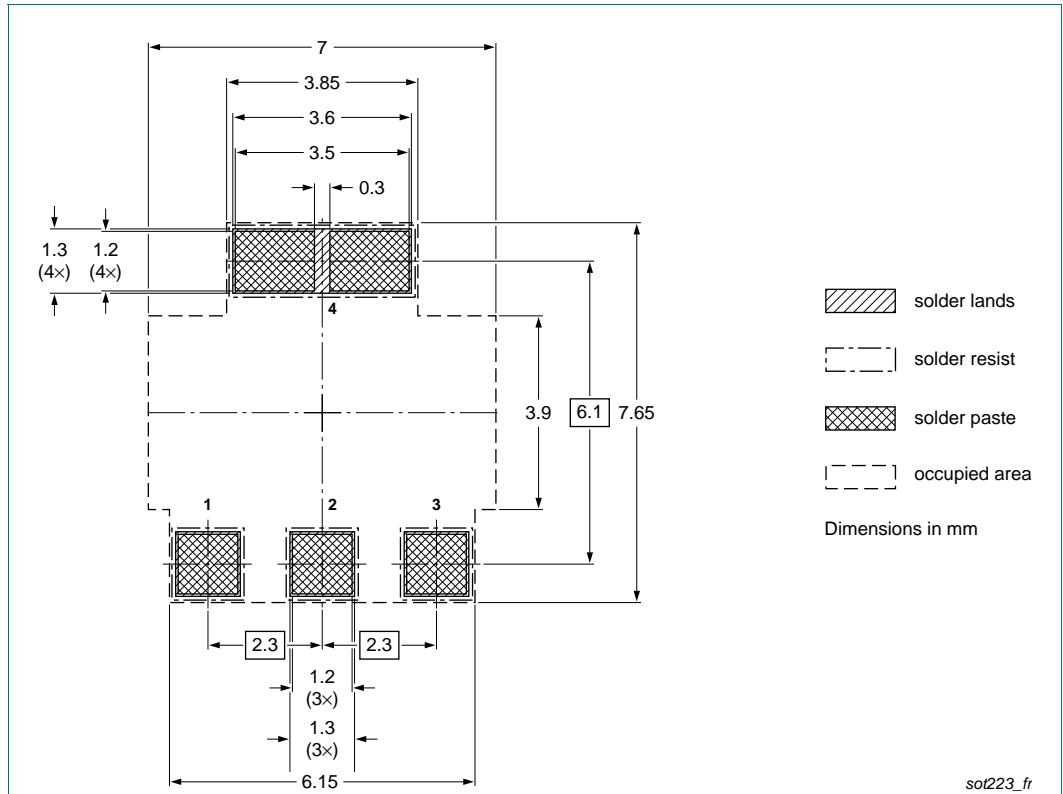

Fig 22. Reflow soldering footprint SOT223 (SC-73)

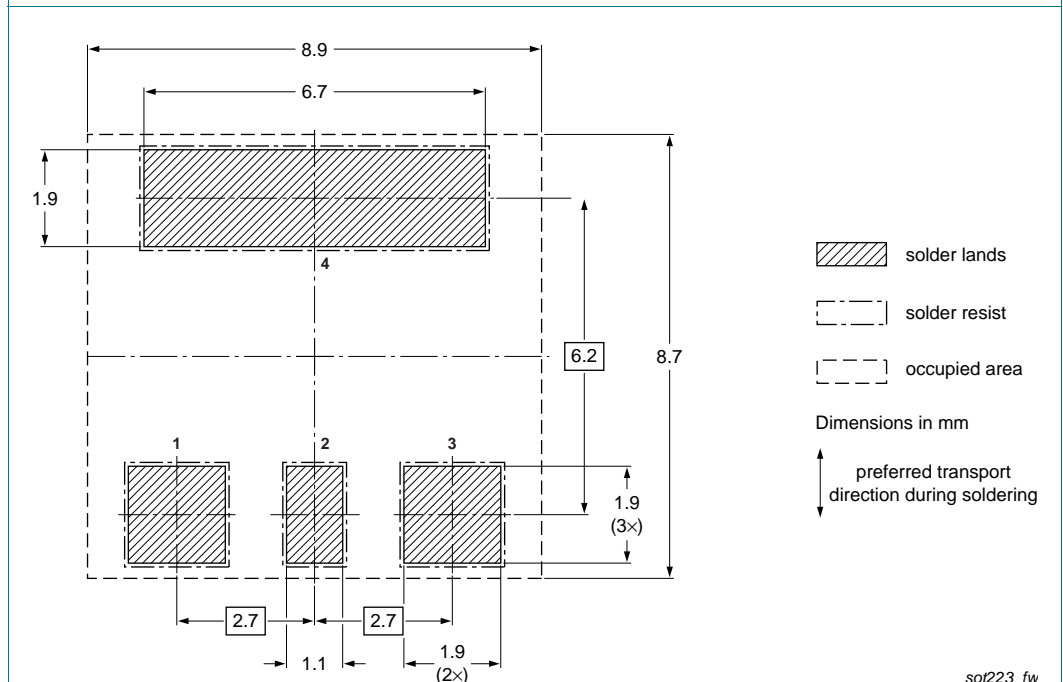

Fig 23. Wave soldering footprint SOT223 (SC-73)

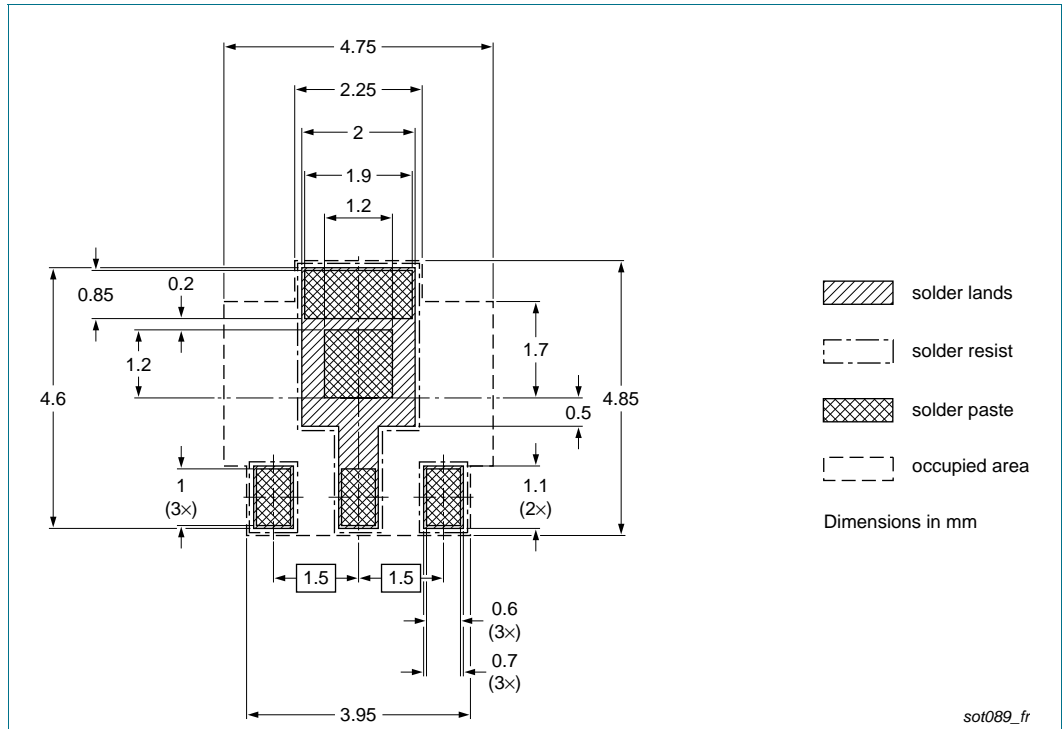

Fig 24. Reflow soldering footprint SOT89 (SC-62/TO-243)

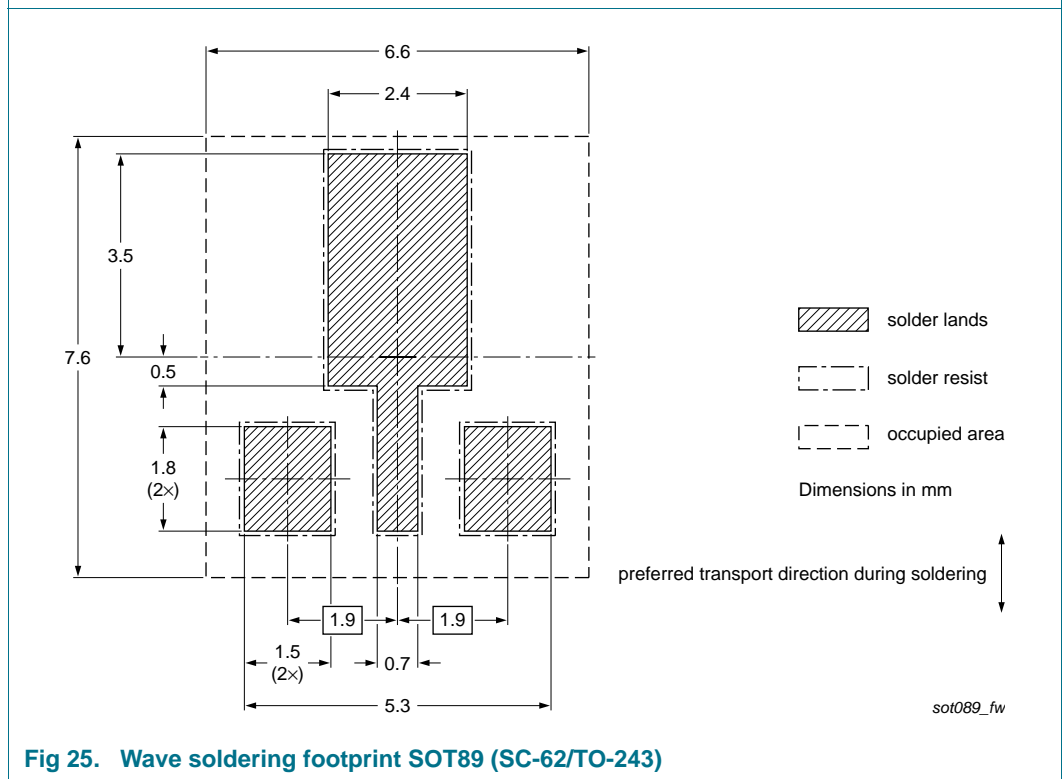
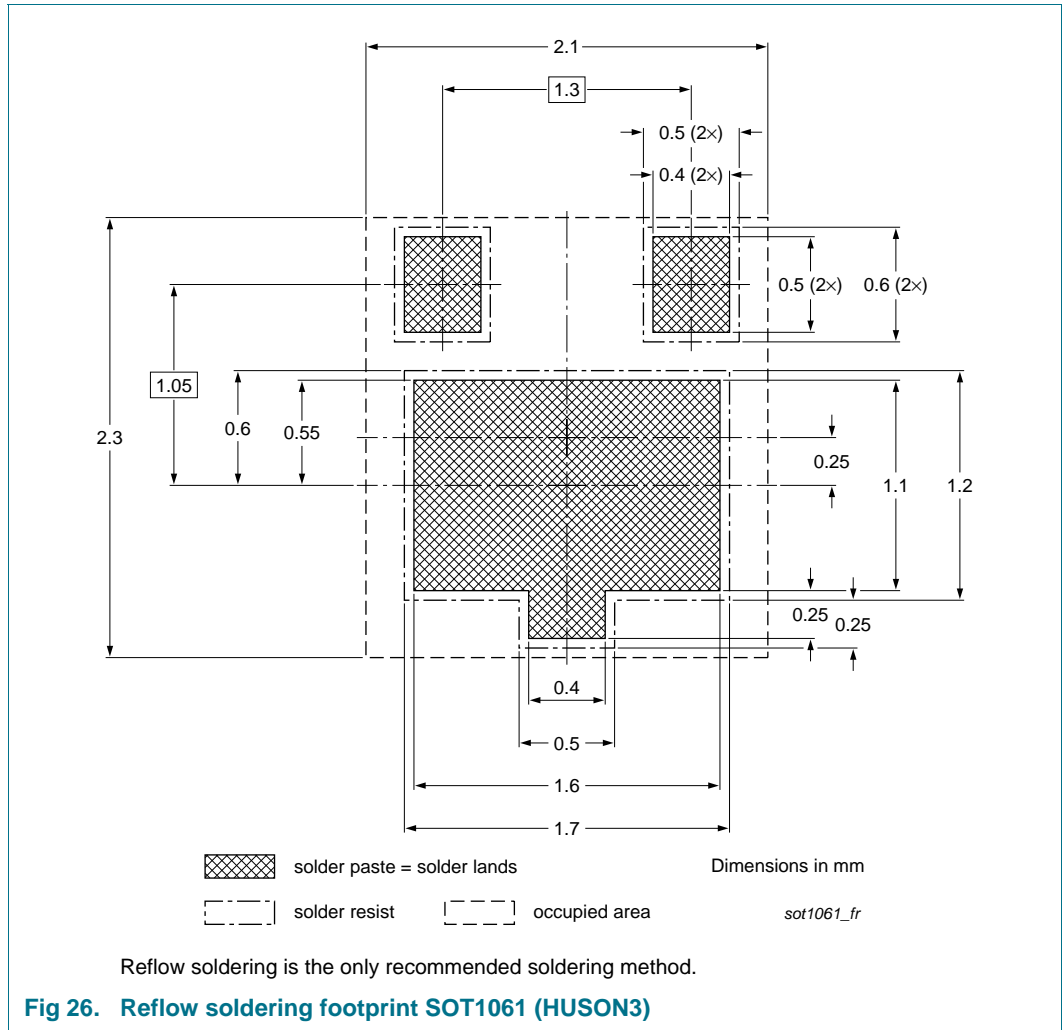

Fig 25. Wave soldering footprint SOT89 (SC-62/TO-243)



12. Revision history

Table 10. Revision history

Document ID	Release date	Data sheet status	Change notice	Supersedes
BCP55_BCX55_BC55PA v.8	20111024	Product data sheet	-	BC637_BCP55_BCX55 v.7
Modifications:		<ul style="list-style-type: none"> Type number removed: BC637 Type number added: BC55PA, BC55-10PA and BC55-16PA Section 1 "Product profile": updated Section 2 "Pinning information": updated Table 6 and 7: updated according to latest measurements Figure 1, 2, 4, 5, 7 to 9, 15, 17 and 18: updated Figure 3, 6, 10 to 14: added Section 8 "Test information": added Section 10 "Packing information": updated Section 11 "Soldering": added Section 13 "Legal information": updated 		
BC637_BCP55_BCX55 v.7	20070625	Product data sheet	-	BC637_BCP55_BCX55 v.6
BC637_BCP55_BCX55 v.6	20050218	Product data sheet	CPCN2004050 29	BC635_637_639 v.4 BCP54_55_56 v.5 BCX54_55_56 v.4
BC635_637_639 v.4	20011010	Product specification	-	BC635_637_639 v.3
BCP54_55_56 v.5	20030206	Product specification	-	BCP54_55_56 v.4
BCX54_55_56 v.4	20011010	Product specification	-	BCX54_55_56 v.3

13. Legal information

13.1 Data sheet status

Document status ^{[1][2]}	Product status ^[3]	Definition
Objective [short] data sheet	Development	This document contains data from the objective specification for product development.
Preliminary [short] data sheet	Qualification	This document contains data from the preliminary specification.
Product [short] data sheet	Production	This document contains the product specification.

[1] Please consult the most recently issued document before initiating or completing a design.

[2] The term 'short data sheet' is explained in section "Definitions".

[3] The product status of device(s) described in this document may have changed since this document was published and may differ in case of multiple devices. The latest product status information is available on the Internet at URL <http://www.nxp.com>.

13.2 Definitions

Draft — The document is a draft version only. The content is still under internal review and subject to formal approval, which may result in modifications or additions. NXP Semiconductors does not give any representations or warranties as to the accuracy or completeness of information included herein and shall have no liability for the consequences of use of such information.

Short data sheet — A short data sheet is an extract from a full data sheet with the same product type number(s) and title. A short data sheet is intended for quick reference only and should not be relied upon to contain detailed and full information. For detailed and full information see the relevant full data sheet, which is available on request via the local NXP Semiconductors sales office. In case of any inconsistency or conflict with the short data sheet, the full data sheet shall prevail.

Product specification — The information and data provided in a Product data sheet shall define the specification of the product as agreed between NXP Semiconductors and its customer, unless NXP Semiconductors and customer have explicitly agreed otherwise in writing. In no event however, shall an agreement be valid in which the NXP Semiconductors product is deemed to offer functions and qualities beyond those described in the Product data sheet.

13.3 Disclaimers

Limited warranty and liability — Information in this document is believed to be accurate and reliable. However, NXP Semiconductors does not give any representations or warranties, expressed or implied, as to the accuracy or completeness of such information and shall have no liability for the consequences of use of such information.

In no event shall NXP Semiconductors be liable for any indirect, incidental, punitive, special or consequential damages (including - without limitation - lost profits, lost savings, business interruption, costs related to the removal or replacement of any products or rework charges) whether or not such damages are based on tort (including negligence), warranty, breach of contract or any other legal theory.

Notwithstanding any damages that customer might incur for any reason whatsoever, NXP Semiconductors' aggregate and cumulative liability towards customer for the products described herein shall be limited in accordance with the *Terms and conditions of commercial sale* of NXP Semiconductors.

Right to make changes — NXP Semiconductors reserves the right to make changes to information published in this document, including without limitation specifications and product descriptions, at any time and without notice. This document supersedes and replaces all information supplied prior to the publication hereof.

Suitability for use — NXP Semiconductors products are not designed, authorized or warranted to be suitable for use in life support, life-critical or safety-critical systems or equipment, nor in applications where failure or

malfunction of an NXP Semiconductors product can reasonably be expected to result in personal injury, death or severe property or environmental damage. NXP Semiconductors accepts no liability for inclusion and/or use of NXP Semiconductors products in such equipment or applications and therefore such inclusion and/or use is at the customer's own risk.

Applications — Applications that are described herein for any of these products are for illustrative purposes only. NXP Semiconductors makes no representation or warranty that such applications will be suitable for the specified use without further testing or modification.

Customers are responsible for the design and operation of their applications and products using NXP Semiconductors products, and NXP Semiconductors accepts no liability for any assistance with applications or customer product design. It is customer's sole responsibility to determine whether the NXP Semiconductors product is suitable and fit for the customer's applications and products planned, as well as for the planned application and use of customer's third party customer(s). Customers should provide appropriate design and operating safeguards to minimize the risks associated with their applications and products.

NXP Semiconductors does not accept any liability related to any default, damage, costs or problem which is based on any weakness or default in the customer's applications or products, or the application or use by customer's third party customer(s). Customer is responsible for doing all necessary testing for the customer's applications and products using NXP Semiconductors products in order to avoid a default of the applications and the products or of the application or use by customer's third party customer(s). NXP does not accept any liability in this respect.

Limiting values — Stress above one or more limiting values (as defined in the Absolute Maximum Ratings System of IEC 60134) will cause permanent damage to the device. Limiting values are stress ratings only and (proper) operation of the device at these or any other conditions above those given in the Recommended operating conditions section (if present) or the Characteristics sections of this document is not warranted. Constant or repeated exposure to limiting values will permanently and irreversibly affect the quality and reliability of the device.

Terms and conditions of commercial sale — NXP Semiconductors products are sold subject to the general terms and conditions of commercial sale, as published at <http://www.nxp.com/profile/terms>, unless otherwise agreed in a valid written individual agreement. In case an individual agreement is concluded only the terms and conditions of the respective agreement shall apply. NXP Semiconductors hereby expressly objects to applying the customer's general terms and conditions with regard to the purchase of NXP Semiconductors products by customer.

No offer to sell or license — Nothing in this document may be interpreted or construed as an offer to sell products that is open for acceptance or the grant, conveyance or implication of any license under any copyrights, patents or other industrial or intellectual property rights.

Export control — This document as well as the item(s) described herein may be subject to export control regulations. Export might require a prior authorization from competent authorities.

Quick reference data — The Quick reference data is an extract of the product data given in the Limiting values and Characteristics sections of this document, and as such is not complete, exhaustive or legally binding.

13.4 Trademarks

Notice: All referenced brands, product names, service names and trademarks are the property of their respective owners.

14. Contact information

For more information, please visit: <http://www.nxp.com>

For sales office addresses, please send an email to: salesaddresses@nxp.com

15. Contents

1	Product profile	1
1.1	General description	1
1.2	Features and benefits	1
1.3	Applications	1
1.4	Quick reference data	1
2	Pinning information	2
3	Ordering information	2
4	Marking	3
5	Limiting values	4
6	Thermal characteristics	6
7	Characteristics	12
8	Test information	14
8.1	Quality information	14
9	Package outline	14
10	Packing information	15
11	Soldering	16
12	Revision history	19
13	Legal information	20
13.1	Data sheet status	20
13.2	Definitions	20
13.3	Disclaimers	20
13.4	Trademarks	21
14	Contact information	21
15	Contents	22

Please be aware that important notices concerning this document and the product(s) described herein, have been included in section 'Legal information'.

© NXP B.V. 2011.

All rights reserved.

For more information, please visit: <http://www.nxp.com>

For sales office addresses, please send an email to: salesaddresses@nxp.com

Date of release: 24 October 2011

Document identifier: BCP55_BCX55_BC55PA

Mouser Electronics

Authorized Distributor

Click to View Pricing, Inventory, Delivery & Lifecycle Information:

[NXP:](#)

[BCP55,135](#) [BCP55-10,115](#) [BCP55-16,115](#) [BCP55,115](#) [BCX55-10,115](#) [BCX55-16,135](#) [BCX55-16,115](#) [BCX55,115](#)
[BC55PA,115](#) [BC55-10PA,115](#) [BC55-16PA,115](#) [BCP55-16F](#)



Стандарт Электрон Связь

Мы молодая и активно развивающаяся компания в области поставок электронных компонентов. Мы поставляем электронные компоненты отечественного и импортного производства напрямую от производителей и с крупнейших складов мира.

Благодаря сотрудничеству с мировыми поставщиками мы осуществляем комплексные и плановые поставки широчайшего спектра электронных компонентов.

Собственная эффективная логистика и склад в обеспечивает надежную поставку продукции в точно указанные сроки по всей России.

Мы осуществляем техническую поддержку нашим клиентам и предпродажную проверку качества продукции. На все поставляемые продукты мы предоставляем гарантию .

Осуществляем поставки продукции под контролем ВП МО РФ на предприятия военно-промышленного комплекса России , а также работаем в рамках 275 ФЗ с открытием отдельных счетов в уполномоченном банке. Система менеджмента качества компании соответствует требованиям ГОСТ ISO 9001.

Минимальные сроки поставки, гибкие цены, неограниченный ассортимент и индивидуальный подход к клиентам являются основой для выстраивания долгосрочного и эффективного сотрудничества с предприятиями радиоэлектронной промышленности, предприятиями ВПК и научно-исследовательскими институтами России.

С нами вы становитесь еще успешнее!

Наши контакты:

Телефон: +7 812 627 14 35

Электронная почта: sales@st-electron.ru

Адрес: 198099, Санкт-Петербург,
Промышленная ул, дом № 19, литера Н,
помещение 100-Н Офис 331