

## MICRO SWITCH™ Miniature Safety Switches

24CE Series

004787

Issue 1

Datasheet



### DESCRIPTION

Honeywell's 24CE Series of miniature electromechanical safety switches are designed with a rugged metal housing. This Series features positive opening normally closed contacts  $\rightarrow$  to EN/IEC 60947-5-1-3 specifications. Due to their small size and positive opening normally closed contact, the 24CE Series provides a safety solution for applications where the size of other products could be prohibitive on the machinery. The 24CE Series offers a variety of configurations which include a wide range of actuators, and circuits to solve many application issues. These miniature switches are weather sealed to IP66 for demanding environments on indoor or outdoor machinery. In addition, the 24CE Series has been evaluated for safety functions up to a safety integrity level (SIL) of SIL3 when evaluated to the requirements of IEC 61508-2:2010.

### VALUE TO CUSTOMERS

- Miniature rugged 24CE switches with common 25,4 mm [1.0 in] mounting footprint
- Switches easily gang mounted for multi-pole capability
- Low temperature option of -40 °C [-40 °F]
- Long life of up to 10 million mechanical operations

### DIFFERENTIATION

- Miniature metal body size of 40 mm L x 16 mm W x 49 mm H [1.58 in L x 0.63 in W x 1.93 in H] requires less space on machinery
- Positive opening normally closed contacts  $\rightarrow$  with an optional normally open contact
- Designed and evaluated for safety functions up to a SIL3 level

### FEATURES

- Compact metal housing epoxy encapsulated with the common 25,4 mm [1.0 in] center-to-center mounting
- Positive opening operation of normally closed contacts  $\rightarrow$  to EN/IEC 60947-5-1-3 specification
- Designed and agency evaluated for safety functions up to a SIL3 level
- Three different slow-action circuit options: 1NC/1NO BBM (break-before-make), 1NC/1NO MBB (make-before-break), and 1NC
- Wide range of actuator heads and levers
- Can be gang mounted for multiple-pole capability
- CE approvals
- Environmentally sealed to IP66
- Standard temperature operating range of 0 °C to 70 °C [32 °F to 158 °F]
- Optional low temperature operating range of -40 °C to 70 °C [-40 °F to 158 °F]

### POTENTIAL APPLICATIONS

- Industrial
  - Machine tools (small doors and apertures)
  - Material handling
  - Packaging machinery
  - Trailer/truck restraint systems (dok-loks)
- Transportation
  - Small construction machinery

### PORTFOLIO

MICRO SWITCH™ 24CE Series miniature safety switches complement the [924CE Series](#) of miniature safety limit switches. These Series of switches are a small segment of the total family of Honeywell's MICRO SWITCH™ electromechanical safety switches.

# MICRO SWITCH™ Miniature Safety Switches, 24CE Series

Table 1. Specifications

Characteristic	Parameter
Description	Miniature safety electromechanical switch
Certifications	CE, SIRA, IEC/EN60947-5-1
Housing material	Epoxy coated die-cast zinc
Actuators	Pin plunger (24CE1-) Roller plunger parallel (24CE2-) Roller plunger perpendicular (24CE3-) Rotary (24CE16-) Pin plunger with boot seal (24CE18-) Roller plunger parallel, panel mount (24CE28-) Roller plunger perpendicular, panel mount (24CE29-) Roller plunger parallel with boot seal (24CE31-) Roller plunger perpendicular with boot seal (24CE55-) Ball-bearing plunger (24CE66-)
Termination (electrical connection)	3-core or 5-core harmonised Cenelec cable
Contact options	1NC/1NO BBM (break-before-make), 1NC/1NO MBB (make-before-break), 1NC (all normally closed contacts are positive opening) →
Contact type	Slow action
Contact material	Silver alloy, gold-plated contacts optional
Utilization category	AC15, B300; DC13, R300
Rated operational voltage (Ue)	240 V ac or dc
Rated operational current	1.5 A, 0.1 A
Rated thermal current (Ith)	10 A
Rated impulse withstand (Uimp)	2500 V
Maximum fuse rating	10 A
Environmental sealing	IP66
Operating temperature	Standard: 0 °C to 70 °C [32 °F to 158 °F] Optional: -40 °C to 70 °C [-40 °F to 158 °F]
MCTF (Mechanical life)	>1,000,000 cycles
MCTF (Electrical life)	>25,000 cycles
SIL Capability	Up to SIL3 (HFT1), IEC61508-2:2010
Proof test interval	1 year

Table 2. Electrical Ratings EN/IEC 60947-5-1

ac				dc			
B300	AC15	VA Rating		R300	DC13	VA Rating	
UE	IE	Make	Break	UE	IE	Make	Break
(Volts)	(Amps)			(Volts)	(Amps)		
120	3	3600	360	125	0.22	28	28
240	1.5	3600	360	250	0.1	28	28

# MICRO SWITCH™ Miniature Safety Switches, 24CE Series

Figure 1. Product Nomenclature

24CE Switch Type	1 Head Type	S Contact Arrangement and Type	3 Cable Length*	A Options**
<b>24CE</b> Miniature Safety Switch	<b>1</b> Top pin plunger Ø 10 mm (sst)	<b>S</b> 1NC/1NO SPDT BBM slow action	<b>1</b> 1 meter of cable	<b>A</b> Side exit cable
	<b>2</b> Top roller plunger parallel, Ø12,7 x 4,7 wide (steel)	<b>T</b> 1NC/1NO SPDT MBB slow action	<b>2</b> 2 meters of cable	<b>B</b> Low temperature construction
	<b>3</b> Top roller plunger perpend., Ø12,7 x 4,7 wide (steel)	<b>Y</b> 1NC SPST slow action	<b>3</b> 3 meters of cable	<b>C</b> Side exit cable and low temperature construction
	<b>16</b> Front rotary (less lever)		<b>4</b> 4 meters of cable	<b>D</b> Halogen-free cable
	<b>18</b> Top pin plunger 10 mm (sst) with boot seal		<b>5</b> 5 meters of cable	<b>G</b> Gold-plated contacts
	<b>28</b> Top roller plunger parallel, Ø12,7 x 4,7 wide (steel), panel mount		<b>6</b> 6 meters of cable	<b>M</b> PUR cable
	<b>29</b> Top roller plunger perpend., Ø12,7 x 4,7 wide (steel), panel mount			
	<b>31</b> Top roller plunger parallel, Ø12,7 x 4,7 wide (steel), boot seal			
	<b>55</b> Top roller plunger perpend., Ø12,7 x 4,7 wide (steel), boot seal			
	<b>66</b> Top ball bearing, Ø 7,9 mm			

\* For other cable lengths available, contact your Honeywell provider.

\*\* More than one option may be permissible.

# MICRO SWITCH™ Miniature Safety Switches, 24CE Series

## GANG-MOUNT CAPABILITY

The 24CE Series housing has been designed to enable the user to build their own multiple plunger switch by gang mounting several switches. All pin plunger and roller plunger types are suitable for gang mounting. There is a 16 mm distance between the plungers. The Series is very versatile such that even a lever-type version could be added at the end of the row.

## BOTTOM-EXIT OR SIDE-EXIT ORIENTATION

The 24CE Series has been designed with a pre-wired cable fitted in the bottom of the switch housing. Other variations are available with a side-exit cable.

## MOUNTING

MICRO SWITCH™ 24CE Series safety switches are mounted by using two M5 or #10 screws. The mounting holes are counter bored to keep the screw heads within the overall switch housing dimensions.

## APPLICATION ILLUSTRATION

Two 24CE roller plunger switches to monitor gate position, closed or open.



## CONTACT ARRANGEMENT AND DESCRIPTION

Circuit Type		Circuit Diagram	Cable/Connector
<b>S</b>	<b>BBM</b>		5 x 0,75 mm <sup>2</sup> harmonised Cenelec cable
<b>T</b>	<b>MBB</b>		5 x 0,75 mm <sup>2</sup> harmonised Cenelec cable
<b>Y</b>	<b>SPNC</b>		3 x 0,75 mm <sup>2</sup> harmonised Cenelec cable

\* Grey with PUR cable.

# MICRO SWITCH™ Miniature Safety Switches, 24CE Series

Table 3. 24CE Order Guide









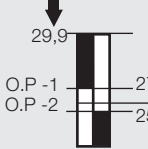

	Head Type	Catalog Listing	Contact Arrangement [slow action]	Operating Force or Torque (max.)	Bar Chart ■ Contact Closed □ Contact Open mm or °	Options	Harmonised Cenelec cable ** length (meters)
	Top pin plunger, Ø 10 mm [sst]	24CE1-S2	1NC/1NO BBM	22,5 N [5.06 lb]		-	2
		24CE1-S2A	1NC/1NO BBM	22,5 N [5.06 lb]		Side-exit cable	2
		24CE1-S2B	1NC/1NO BBM	22,5 N [5.06 lb]		Side-exit cable and -40 °C [-40 °F] low temp. construction	2
		24CE1-S3	1NC/1NO BBM	22,5 N [5.06 lb]		-	3
		24CE1-S6	1NC/1NO BBM	22,5 N [5.06 lb]		-	6
		24CE1-S6A	1NC/1NO BBM	22,5 N [5.06 lb]		Side-exit cable	6
		24CE1-Y1	1NC	22,5 N [5.06 lb]		-	1
		24CE1-Y1A	1NC	22,5 N [5.06 lb]		Side-exit cable	1
		24CE1-Y2	1NC	22,5 N [5.06 lb]		-	2
		24CE1-Y2A	1NC	22,5 N [5.06 lb]		Side-exit cable	2
		24CE1-Y3	1NC	22,5 N [5.06 lb]		-	3
		24CE1-Y8B	1NC	22,5 N [5.06 lb]		-40 °C [-40 °F] low temp. construction	8
	Top roller plunger, parallel Ø12,7 x 4,7 mm wide [steel]	24CE2-S1	1NC/1NO BBM	22,5 N [5.06 lb]		-	1
		24CE2-S2	1NC/1NO BBM	22,5 N [5.06 lb]		-	2
		24CE2-S2A	1NC/1NO BBM	22,5 N [5.06 lb]		Side-exit cable	2
		24CE2-S2B	1NC/1NO BBM	22,5 N [5.06 lb]		-40 °C [-40 °F] low temp. construction	2
		24CE2-S3	1NC/1NO BBM	22,5 N [5.06 lb]		-	3
		24CE2-S6	1NC/1NO BBM	22,5 N [5.06 lb]		-	6
		24CE2-T1GM	1NC/1NO MBB	22,5 N [5.06 lb]		Gold plated contacts, PUR cable	1
		24CE2-T2	1NC/1NO MBB	22,5 N [5.06 lb]		-	2
		24CE2-Y1	1NC	22,5 N [5.06 lb]		-	1
		24CE2-Y1B	1NC	22,5 N [5.06 lb]		-40 °C [-40 °F] low temp. construction	2
		24CE2-Y2	1NC	22,5 N [5.06 lb]		-	2
		24CE2-Y2A	1NC	22,5 N [5.06 lb]		Side-exit cable	2
		24CE2-Y4	1NC	22,5 N [5.06 lb]		-	4
		24CE2-Y6A	1NC	22,5 N [5.06 lb]		Side-exit cable	6

\* Positive opening to IEC/EN 60947-5-1-3.

\*\*For other cable lengths, contact your Honeywell provider.

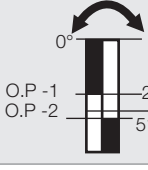
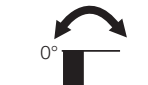
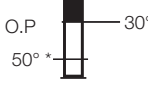
# MICRO SWITCH™ Miniature Safety Switches, 24CE Series

Table 3. 24CE Order Guide, continued

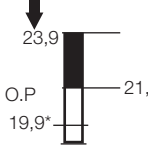
	Head Type	Catalog Listing	Contact Arrangement [slow action]	Operating Force or Torque (max.)	Bar Chart ■ Contact Closed □ Contact Open mm or °	Options	Harmonised Cenelec cable ** length (meters)
	Top roller plunger, perpendicular Ø12,7 x 4,7 mm wide [steel]	24CE3-S2	1NC/1NO BBM	22,5 N [5.06 lb]		-	2
		24CE3-S2A	1NC/1NO BBM	22,5 N [5.06 lb]		Side-exit cable	2
		24CE3-S3	1NC/1NO BBM	22,5 N [5.06 lb]		-	3
		24CE3-Y1	1NC	22,5 N [5.06 lb]		-	1
		24CE3-Y2	1NC	22,5 N [5.06 lb]		-	2
		24CE3-Y2A	1NC	22,5 N [5.06 lb]		Side-exit cable	2
	Front rotary [less lever]	24CE16-S1	1NC/1NO BBM	0,30 Nm [2.66 in-lb]		-	1
		24CE16-Y1	1NC	0,30 Nm [2.66 in-lb]		-	1
		24CE16-Y6	1NC	0,30 Nm [2.66 in-lb]		-	6
	Top pin plunger, Ø7,1 mm [sst] w boot seal	24CE18-S1	1NC/1NO BBM	22,5 N [5.06 lb]		-	1
		24CE18-S2	1NC/1NO BBM	22,5 N [5.06 lb]		-	2
		24CE18-Y7AM	1NC	22,5 N [5.06 lb]		PUR cable, side exit	7

\* Positive opening to IEC/EN 60947-5-1-3.

\*\*For other cable lengths, contact your Honeywell provider.

# MICRO SWITCH™ Miniature Safety Switches, 24CE Series

Table 3. 24CE Order Guide, continued

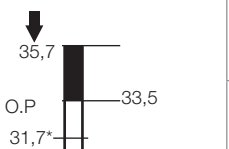
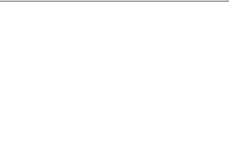
	Head Type	Catalog Listing	Contact Arrangement [slow action]	Operating Force or Torque (max.)	Bar Chart ■ Contact Closed □ Contact Open mm or °	Options	Harmonised Cenelec cable ** length (meters)
 <p>Top roller plunger, parallel Ø12,7 x 4,7 mm wide (steel) with boot seal</p>	24CE31-S1	1NC/1NO BBM	25,5 N [5.73 lb]		-	1	
	24CE31-S1A	1NC/1NO BBM	25,5 N [5.73 lb]		Side-exit cable	1	
	24CE31-S1C	1NC/1NO BBM	25,5 N [5.73 lb]		Side-exit cable, -40 °C [-40 °F] low temp. construction	1	
	24CE31-S2	1NC/1NO BBM	25,5 N [5.73 lb]		-	2	
	24CE31-S2A	1NC/1NO BBM	25,5 N [5.73 lb]		Side-exit cable	2	
	24CE31-S2B	1NC/1NO BBM	25,5 N [5.73 lb]		-40 °C [-40 °F] low temp. construction	2	
	24CE31-S5	1NC/1NO BBM	25,5 N [5.73 lb]		-	5	
	24CE31-T2	1NC/1NO MBB	25,5 N [5.73 lb]			-	2
	24CE31-Y1	1NC	25,5 N [5.73 lb]			-	1
	24CE31-Y2	1NC	25,5 N [5.73 lb]			-	2
24CE31-Y3	1NC	25,5 N [5.73 lb]	-	3			
24CE31-Y5	1NC	25,5 N [5.73 lb]	-	5			
 <p>Top roller plunger, perpendicular Ø12,7 x 4,7 mm wide [steel] with boot seal</p>	24CE55-S1	1NC/1NO BBM	25,5 N [5.73 lb]		-	1	
	24CE55-T2A	1NC/1NO MBB	25,5 N [5.73 lb]		Side-exit cable	2	
	24CE55-Y1	1NC	25,5 N [5.73 lb]		-	1	
	24CE55-Y2	1NC	25,5 N [5.73 lb]		-	2	

\* Positive opening to IEC/EN 60947-5-1-3.

\*\*For other cable lengths, contact your Honeywell provider.

# MICRO SWITCH™ Miniature Safety Switches, 24CE Series

## DIMENSIONAL DRAWINGS

Figure 2. 24CE General Dimensions





# MICRO SWITCH™ Miniature Safety Switches, 24CE Series

## DIMENSIONAL DRAWINGS mm [in]

Figure 3. 24CE1 Dimensions



Pin Plunger Operating Characteristics	S	T	Y
	1NC/1NO (BBM)	1NC/1NO (MBB)	1NC
Free position (±0,4 [0.02])	17,1 [0.67]	17,1 [0.67]	17,1 [0.67]
Pretravel (max.)	2,2 [0.09]	4,0 [0.16]	2,2 [0.09]
Overtravel (min.)	1,0 [0.04]	0,5 [0.02]	-

Figure 4. 24CE2 Dimensions



Roller Plunger Operating Characteristics	S	T	Y
	1NC/1NO (BBM)	1NC/1NO (MBB)	1NC
Free position (±0,4 [0.02])	29,9 [1.18]	29,9 [1.18]	29,9 [1.18]
Pretravel (max.)	2,2 [0.09]	4,0 [0.16]	2,2 [0.09]
Overtravel (min.)	1,0 [0.04]	0,5 [0.02]	-

Figure 5. 24CE3 Dimensions



Roller Plunger Operating Characteristics	S	T	Y
	1NC/1NO (BBM)	1NC/1NO (MBB)	1NC
Free position (±0,4 [0.02])	29,9 [1.18]	29,9 [1.18]	29,9 [1.18]
Pretravel (max.)	2,2 [0.09]	4,0 [0.16]	2,2 [0.09]
Overtravel (min.)	1,0 [0.04]	0,5 [0.02]	-

Figure 6. 24CE16 Dimensions

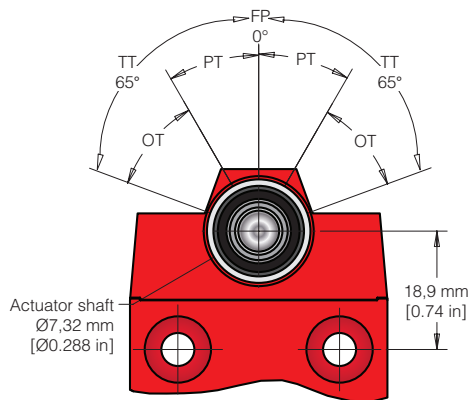

Side Rotary Operating Characteristics	S	T	Y
	1NC/1NO (BBM)	1NC/1NO (MBB)	1NC
Free position (degrees)	0	0	0
Pretravel (max. degrees)	26	48	26
Total travel (min. degrees)	65	65	65

Figure 7. 24CE18 Dimensions

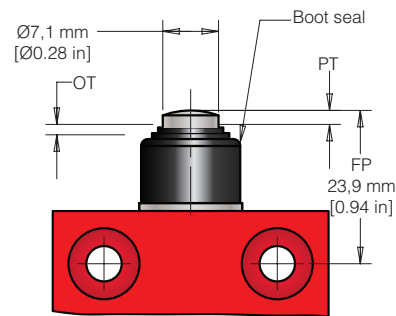

Pin Plunger with Boot Seal Operating Characteristics	S	T	Y
	1NC/1NO (BBM)	1NC/1NO (MBB)	1NC
Free position (±0,4 [0.02])	23,9 [0.94]	23,9 [0.94]	23,9 [0.94]
Pretravel (max.)	2,2 [0.09]	4,0 [0.16]	2,2 [0.09]
Overtravel (min.)	1,0 [0.04]	0,5 [0.02]	-

Figure 8. 24CE28 Dimensions



Top Roller Plunger with Panel Mount Operating Characteristics	S	T	Y
	1NC/1NO (BBM)	1NC/1NO (MBB)	1NC
Free position (±0,4 [0.02])	43,9 [1.73]	43,9 [1.73]	43,9 [1.73]
Pretravel (max.)	2,2 [0.09]	4,0 [0.16]	2,2 [0.09]
Overtravel (min.)	1,0 [0.04]	0,5 [0.02]	-

# MICRO SWITCH™ Miniature Safety Switches, 24CE Series

Figure 9. 24CE29 Dimensions



Top Roller Plunger with Panel Mount Operating Characteristics	S 1NC/1NO (BBM)	T 1NC/1NO (MBB)	Y 1NC
Free position (±0,4 [0.02])	43,9 [1.73]	43,9 [1.73]	43,9 [1.73]
Pretravel (max.)	2,2 [0.09]	4,0 [0.16]	2,2 [0.09]
Overtravel (min.)	1,0 [0.04]	0,5 [0.02]	-

Figure 10. 24CE31 Dimensions



Roller Plunger with Boot Seal Operating Characteristics	S 1NC/1NO (BBM)	T 1NC/1NO (MBB)	Y 1NC
Free position (±0,4 [0.02])	35,7 [1.41]	35,7 [1.41]	35,7 [1.41]
Pretravel (max.)	2,2 [0.09]	4,0 [0.16]	2,2 [0.09]
Overtravel (min.)	1,0 [0.04]	0,5 [0.02]	-

Figure 11. 24CE55 Dimensions



Roller Plunger with Boot Seal Operating Characteristics	S 1NC/1NO (BBM)	T 1NC/1NO (MBB)	Y 1NC
Free position (±0,4 [0.02])	35,7 [1.41]	35,7 [1.41]	35,7 [1.41]
Pretravel (max.)	2,2 [0.09]	4,0 [0.16]	2,2 [0.09]
Overtravel (min.)	1,0 [0.04]	0,5 [0.02]	-

Figure 12. 24CE66 Dimensions



Ball Bearing Plunger Operating Characteristics	S 1NC/1NO (BBM)	T 1NC/1NO (MBB)	Y 1NC
Free position (±0,4 [0.02])	32,0 [1.26]	32,0 [1.26]	32,0 [1.26]
Pretravel (max.)	2,2 [0.09]	4,0 [0.16]	2,2 [0.09]
Overtravel (min.)	1,0 [0.04]	0,5 [0.02]	-

Table 4. Levers for Use with 24CE Front Rotary Switches

	Catalog Listing	Rod/Roller Material	Rod/Roller Dia. mm [in]	Roller Width mm [in]
<b>Fixed length lever; 38,1 mm [1.5 in] radius</b>				
	GLZ51A	Nylon	19,0 [0.75]	6,35 [0.25]
	GLZ51B	Steel	19,0 [0.75]	6,35 [0.25]
	GLZ51C	Nylon	25,4 [1.00]	12,7 [0.50]
	GLZ51E	Bronze	19,0 [0.75]	6,35 [0.25]
	GLZ51T	SST	19,0 [0.75]	9,5 [0.38]
<b>Fixed length offset lever; 38,1 mm [1.5 in] radius</b>				
	GLZ55A	Nylon	19,0 [0.75]	6,35 [0.25]
	GLZ55B	Steel	19,0 [0.75]	6,35 [0.25]
	GLZ55E	Bronze	19,0 [0.75]	6,35 [0.25]

## ADDITIONAL MATERIALS

The following associated literature is available on the Honeywell web site at [sensing.honeywell.com](http://sensing.honeywell.com):

- Product line guide
- Product range guide
- Installation instructions
- Certificates: SIL
- Certificates: Electrical endurance
- Certificates: Mechanical endurance
- Safety switch quick reference guide

### Find out more

Honeywell serves its customers through a worldwide network of sales offices, representatives and distributors. For application assistance, current specifications, pricing or name of the nearest Authorized Distributor, contact your local sales office. To learn more about Honeywell's sensing and control products, call **+1-815-235-6847** or **1-800-537-6945**, visit **[sensing.honeywell.com](http://sensing.honeywell.com)**, or e-mail inquiries to **[info.sc@honeywell.com](mailto:info.sc@honeywell.com)**

Sensing and Productivity Solutions  
Honeywell  
1985 Douglas Drive North  
Golden Valley, MN 55422  
**[honeywell.com](http://honeywell.com)**

### **WARNING** **RISK TO LIFE OR PROPERTY**

Never use this product for an application involving serious risk to life or property without ensuring that the system as a whole has been designed to address the risks, and that this product is properly rated and installed for the intended use within the overall system.

**Failure to comply with these instructions could result in death or serious injury.**

### **WARNING** **MISUSE OF DOCUMENTATION**

- The information presented in this product sheet is for reference only. Do not use this document as a product installation guide.
- Complete installation, operation, and maintenance information is provided in the instructions supplied with each product.

**Failure to comply with these instructions could result in death or serious injury.**

### Warranty/Remedy

Honeywell warrants goods of its manufacture as being free of defective materials and faulty workmanship. Honeywell's standard product warranty applies unless agreed to otherwise by Honeywell in writing; please refer to your order acknowledgement or consult your local sales office for specific warranty details. If warranted goods are returned to Honeywell during the period of coverage, Honeywell will repair or replace, at its option, without charge those items it finds defective. **The foregoing is buyer's sole remedy and is in lieu of all other warranties, expressed or implied, including those of merchantability and fitness for a particular purpose. In no event shall Honeywell be liable for consequential, special, or indirect damages.**

While we provide application assistance personally, through our literature and the Honeywell web site, it is up to the customer to determine the suitability of the product in the application.

Specifications may change without notice. The information we supply is believed to be accurate and reliable as of this printing. However, we assume no responsibility for its use.

# Honeywell



## Стандарт Электрон Связь

Мы молодая и активно развивающаяся компания в области поставок электронных компонентов. Мы поставляем электронные компоненты отечественного и импортного производства напрямую от производителей и с крупнейших складов мира.

Благодаря сотрудничеству с мировыми поставщиками мы осуществляем комплексные и плановые поставки широчайшего спектра электронных компонентов.

Собственная эффективная логистика и склад в обеспечивает надежную поставку продукции в точно указанные сроки по всей России.

Мы осуществляем техническую поддержку нашим клиентам и предпродажную проверку качества продукции. На все поставляемые продукты мы предоставляем гарантию .

Осуществляем поставки продукции под контролем ВП МО РФ на предприятия военно-промышленного комплекса России , а также работаем в рамках 275 ФЗ с открытием отдельных счетов в уполномоченном банке. Система менеджмента качества компании соответствует требованиям ГОСТ ISO 9001.

Минимальные сроки поставки, гибкие цены, неограниченный ассортимент и индивидуальный подход к клиентам являются основой для выстраивания долгосрочного и эффективного сотрудничества с предприятиями радиоэлектронной промышленности, предприятиями ВПК и научно-исследовательскими институтами России.

С нами вы становитесь еще успешнее!

### Наши контакты:

**Телефон:** +7 812 627 14 35

**Электронная почта:** [sales@st-electron.ru](mailto:sales@st-electron.ru)

**Адрес:** 198099, Санкт-Петербург,  
Промышленная ул, дом № 19, литера Н,  
помещение 100-Н Офис 331