

## HB-2X2-ON

~15° + 50° oval beam

### TECHNICAL SPECIFICATIONS:

Dimensions	50.0 mm
Height	10 mm
Fastening	screw
ROHS compliant	yes 

### MATERIAL SPECIFICATIONS:

Component	Type	Material	Colour	Finish
HB-2X2-ON	Multi-lens	PMMA	clear	







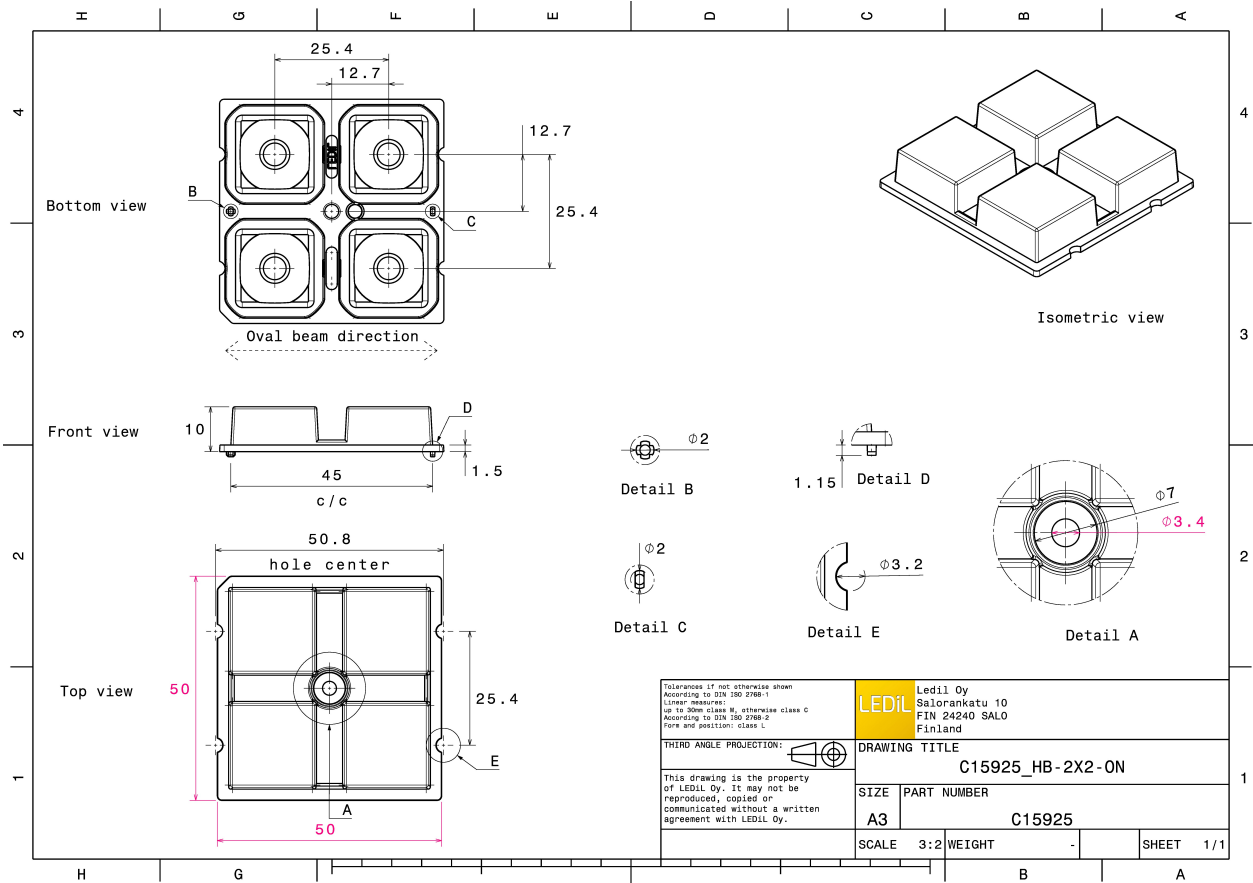

### ORDERING INFORMATION:

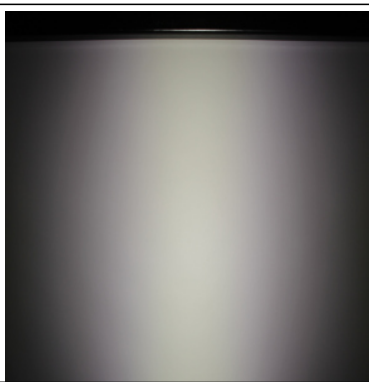
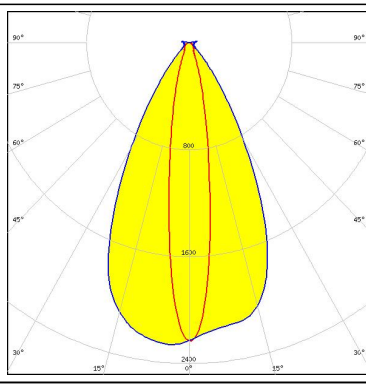
Component	Qty in box	MOQ	MPQ	Box weight (kg)
C15925_HB-2X2-ON » Box size: 480 x 280 x 300 mm	800	160	160	9.8

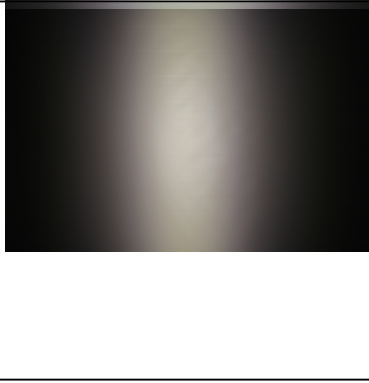
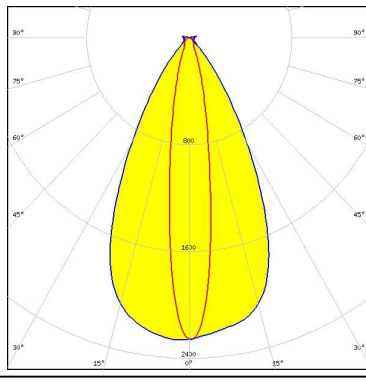

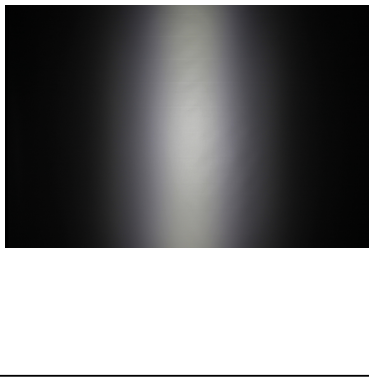
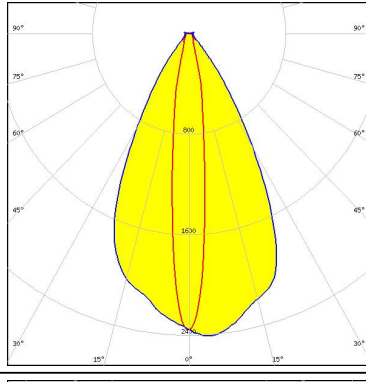
#### PHOTOMETRIC DATA (MEASURED):

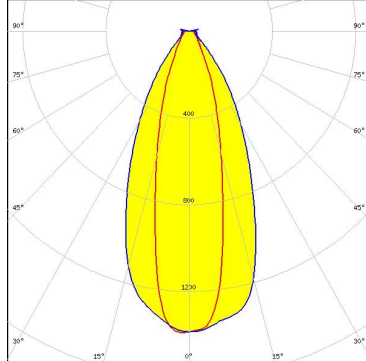
<p></p> <p>LED QUICK FLUX XTP 2x4 xxx LS G5            FWHM 16.0 + 55.0°            Efficiency 93 %            Peak intensity 2.3 cd/lm            LEDs/each optic 1            Light colour White            Required components:</p>		
<p></p> <p>LED QUICK FLUX XTP 2x6 xxx LS G5            FWHM 16.0 + 55.0°            Efficiency 93 %            Peak intensity 2.3 cd/lm            LEDs/each optic 1            Light colour White            Required components:</p>		
<p></p> <p>LED XD16            FWHM 13.0 + 55.0°            Efficiency 89 %            Peak intensity 2.4 cd/lm            LEDs/each optic 1            Light colour White            Required components:</p>		
<p></p> <p>LED XD16            FWHM 27.0 + 49.0°            Efficiency 90 %            Peak intensity 1.4 cd/lm            LEDs/each optic 4            Light colour White            Required components:</p>		

#### PHOTOMETRIC DATA (MEASURED):



LED XP-G2  
 FWHM 14.0 + 55.0°  
 Efficiency 89 %  
 Peak intensity 2.7 cd/lm  
 LEDs/each optic 1  
 Light colour White  
 Required components:

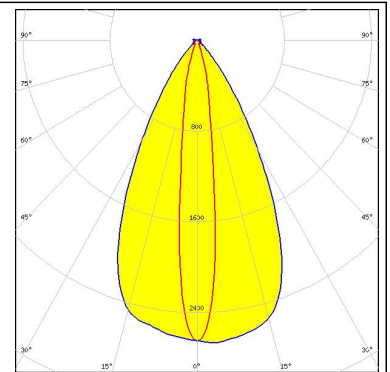

LED XP-L HI  
 FWHM 14.0 + 55.0°  
 Efficiency 91 %  
 Peak intensity 2.6 cd/lm  
 LEDs/each optic 1  
 Light colour White  
 Required components:

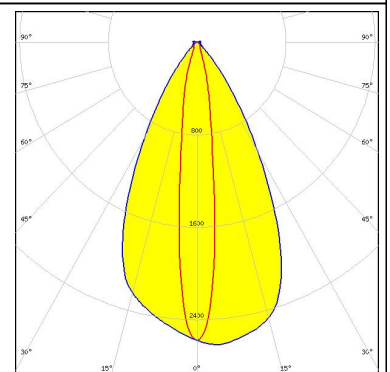
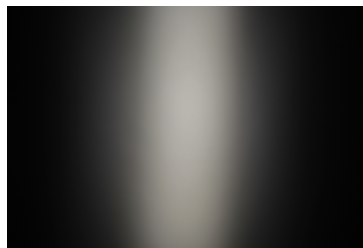

LED LUXEON V  
 FWHM 22.0 + 51.0°  
 Efficiency 92 %  
 Peak intensity 1.8 cd/lm  
 LEDs/each optic 1  
 Light colour White  
 Required components:

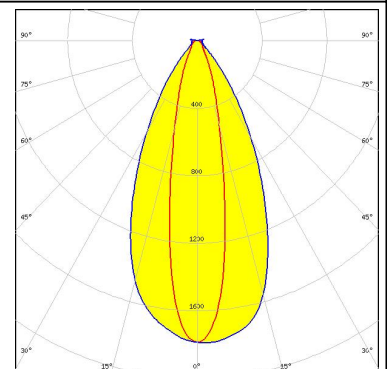
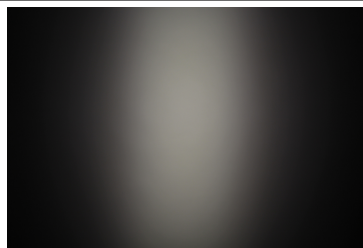

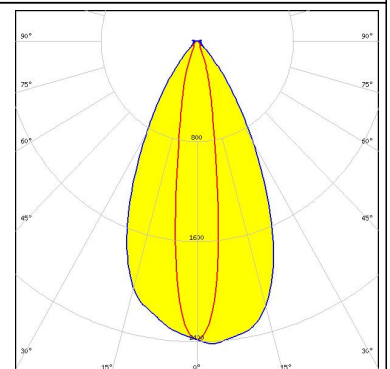
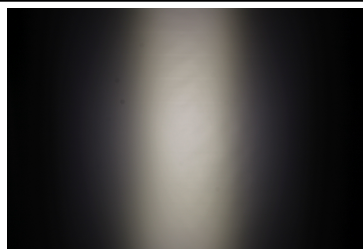

LED NVSW219F  
 FWHM 17.0 + 53.0°  
 Efficiency 93 %  
 Peak intensity 2.4 cd/lm  
 LEDs/each optic 1  
 Light colour White  
 Required components:

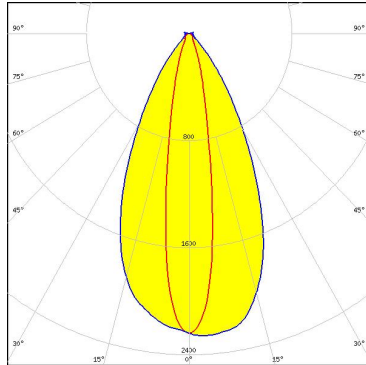
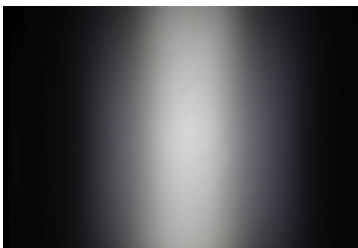
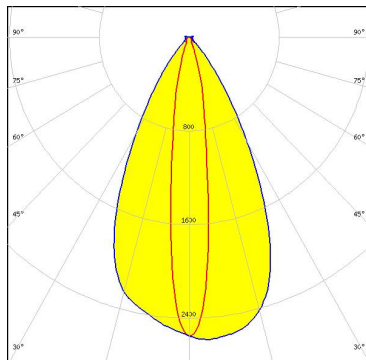
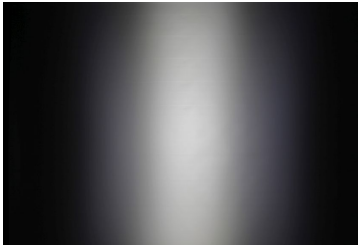
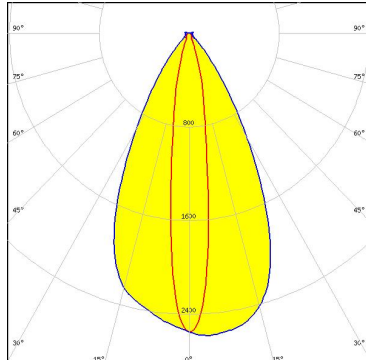
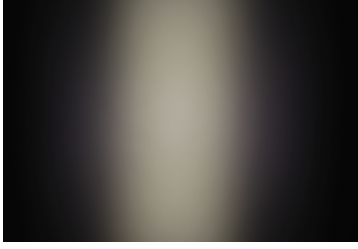
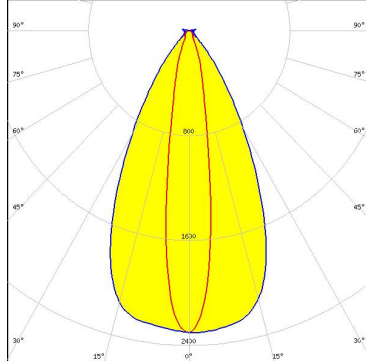

#### PHOTOMETRIC DATA (MEASURED):

<p><b>NICHIA</b></p> <p>LED NVSW319B            FWHM 18.0 + 52.0°            Efficiency 93 %            Peak intensity 2.3 cd/lm            LEDs/each optic 1            Light colour White            Required components:</p>		
<p><b>OSRAM</b></p> <p>LED PrevaLED Brick HP 2x8            FWHM 15.0 + 54.0°            Efficiency 91 %            Peak intensity 2.6 cd/lm            LEDs/each optic 1            Light colour White            Required components:</p>		
<p><b>OSRAM</b>  <small>Opto Semiconductors</small></p> <p>LED OSLON Square CSSRM2/CSSRM3            FWHM 15.0 + 54.0°            Efficiency 91 %            Peak intensity 2.6 cd/lm            LEDs/each optic 1            Light colour White            Required components:</p>		
<p><b>SAMSUNG</b></p> <p>LED HiLOM RH16 (LH351C)            FWHM 17.0 + 54.0°            Efficiency 94 %            Peak intensity 2.3 cd/lm            LEDs/each optic 1            Light colour White            Required components:</p>		

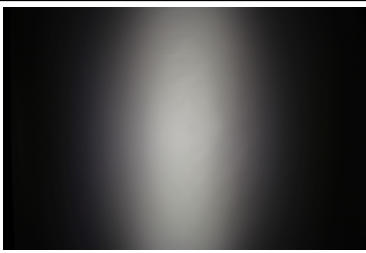
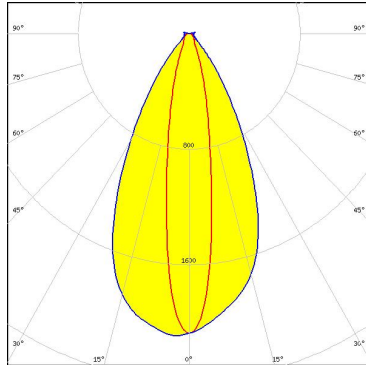
#### PHOTOMETRIC DATA (MEASURED):

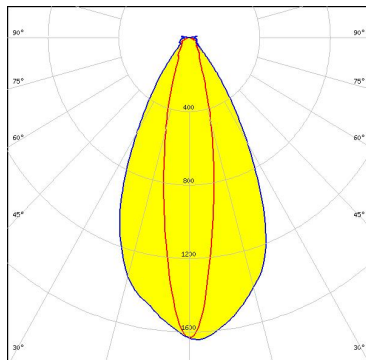
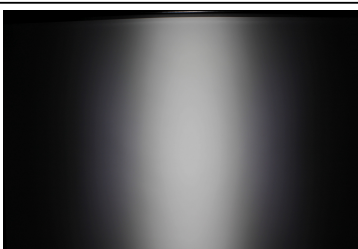
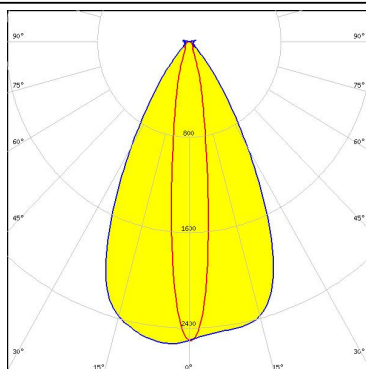
<p><b>SEOL</b> SEOL SEMICONDUCTOR</p> <p>LED Z5M3 FWHM 18.0 + 53.0° Efficiency 93 % Peak intensity 2.1 cd/lm LEDs/each optic 1 Light colour White Required components:</p>		
<p><b>SEOL</b> SEOL SEMICONDUCTOR</p> <p>LED Z8Y22 FWHM 20.0 + 53.0° Efficiency 91 % Peak intensity 1.6 cd/lm LEDs/each optic 1 Light colour White Required components:</p>		
<p><b>TRIDONIC</b></p> <p>LED RLE 2x4 2000lm HP EXC2 OTD FWHM 15.0 + 55.0° Efficiency 94 % Peak intensity 2.5 cd/lm LEDs/each optic 1 Light colour White Required components:</p>		
<p><b>TRIDONIC</b></p> <p>LED RLE 2x8 4000lm HP EXC2 OTD FWHM 15.0 + 55.0° Efficiency 94 % Peak intensity 2.5 cd/lm LEDs/each optic 1 Light colour White Required components:</p>		

#### PHOTOMETRIC DATA (SIMULATED):



LED XHP35 HI  
 FWHM 16.0 + 50.0°  
 Efficiency 90 %  
 LEDs/each optic 1  
 Light colour White  
 Required components:

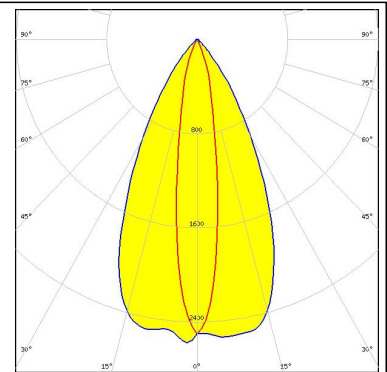

LED XP-E2  
 FWHM 54.0 + 10.0°  
 Efficiency 93 %  
 Peak intensity 3.8 cd/lm  
 LEDs/each optic 1  
 Light colour White  
 Required components:

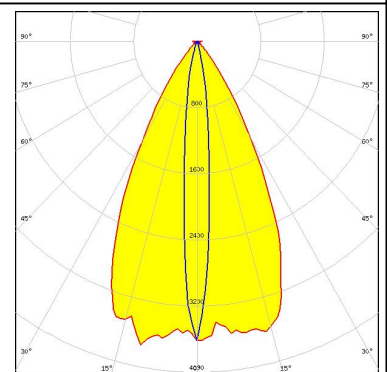

LED XP-E2  
 FWHM 10.0 + 50.0°  
 Efficiency 90 %  
 LEDs/each optic 1  
 Light colour White  
 Required components:

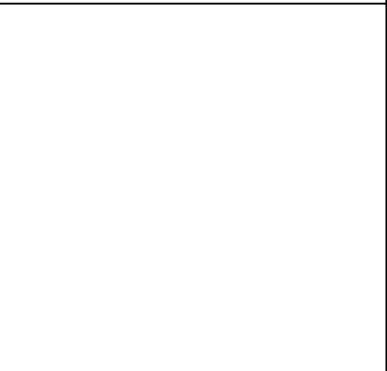

LED XP-G2 HE  
 FWHM 18.0 + 51.0°  
 Efficiency 90 %  
 Peak intensity 2.4 cd/lm  
 LEDs/each optic 1  
 Light colour White  
 Required components:

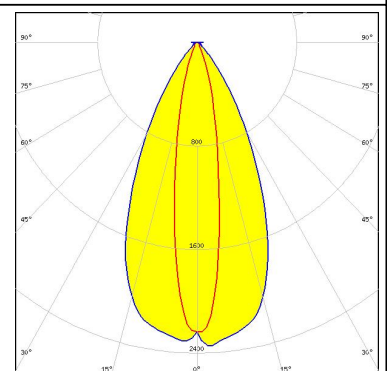

#### PHOTOMETRIC DATA (SIMULATED):



LED XP-G3  
 FWHM 17.0 + 48.0°  
 Efficiency 89 %  
 LEDs/each optic 1  
 Light colour White  
 Required components:

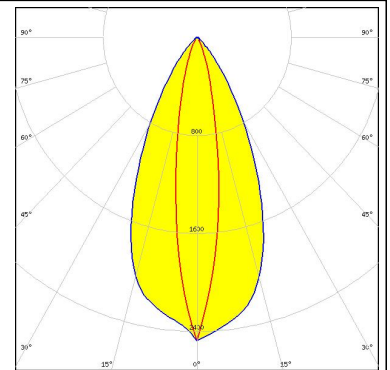

LED XP-L HD  
 FWHM 18.0 + 50.0°  
 Efficiency 88 %  
 LEDs/each optic 1  
 Light colour White  
 Required components:

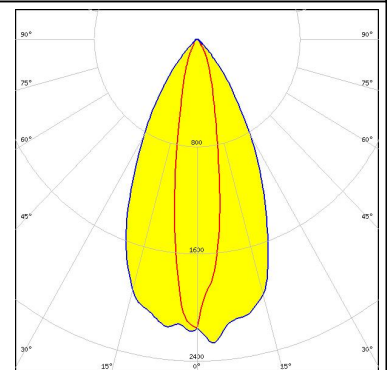

LED XT-E  
 FWHM 14.0 + 55.0°  
 Efficiency 91 %  
 Peak intensity 2.9 cd/lm  
 LEDs/each optic 1  
 Light colour White  
 Required components:

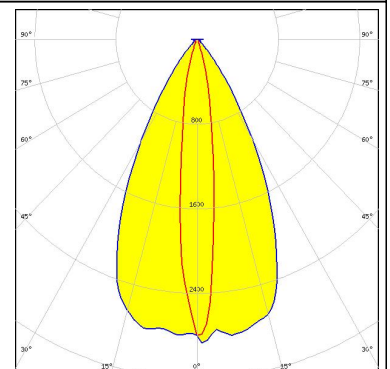

LED LUXEON 5050 Round LES  
 FWHM 23.0 + 51.0°  
 Efficiency 89 %  
 Peak intensity 1.7 cd/lm  
 LEDs/each optic 1  
 Light colour White  
 Required components:

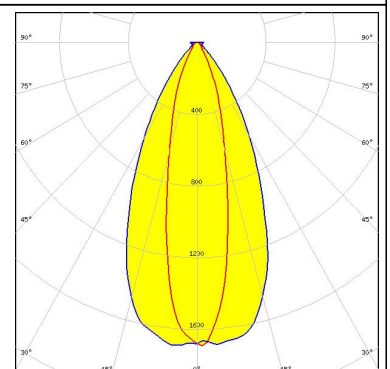



#### PHOTOMETRIC DATA (SIMULATED):

##### LUMILEDS

LED LUXEON C  
 FWHM 12.0 + 54.0°  
 Efficiency 91 %  
 Peak intensity 3.4 cd/lm  
 LEDs/each optic 1  
 Light colour White  
 Required components:

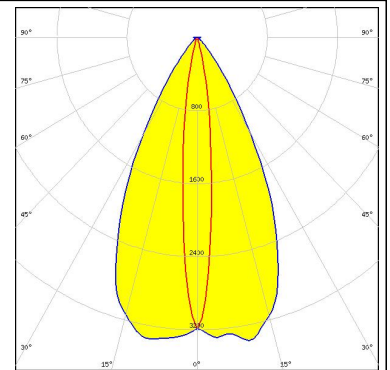

##### LUMILEDS

LED LUXEON TX  
 FWHM 14.0 + 50.0°  
 Efficiency 90 %  
 LEDs/each optic 1  
 Light colour White  
 Required components:

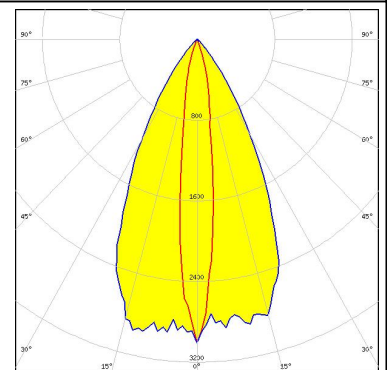

##### NICHIA

LED NV4WB35AM  
 FWHM 20.0 + 50.0°  
 Efficiency 90 %  
 Peak intensity 2.1 cd/lm  
 LEDs/each optic 1  
 Light colour White  
 Required components:

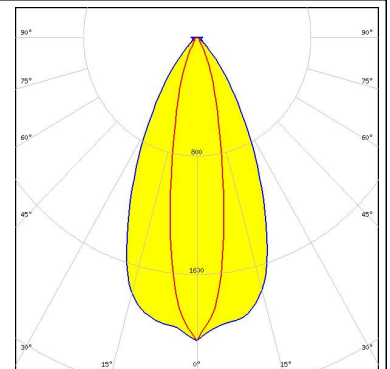

##### NICHIA

LED NVSxx19B/NVSxx19C  
 FWHM 16.0 + 53.0°  
 Efficiency 90 %  
 Peak intensity 2.5 cd/lm  
 LEDs/each optic 1  
 Light colour White  
 Required components:

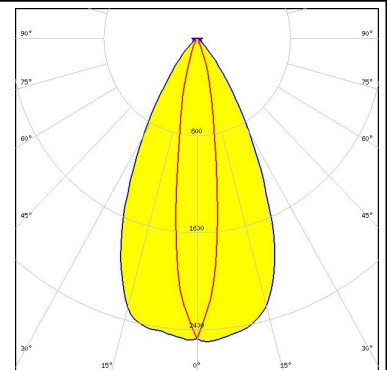

#### PHOTOMETRIC DATA (SIMULATED):

**OSRAM**  
Opto Semiconductors

LED Duris S8  
FWHM 29.0 + 49.0°  
Efficiency 84 %  
Peak intensity 1.4 cd/lm  
LEDs/each optic 1  
Light colour White  
Required components:

Transparent protective cover

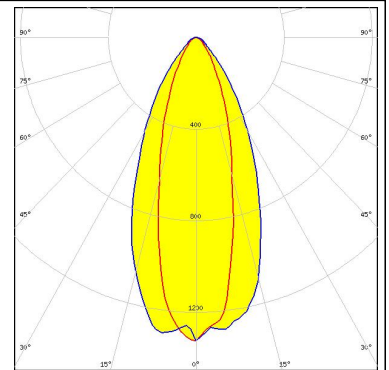

**OSRAM**  
Opto Semiconductors

LED Duris S8  
FWHM 26.0 + 49.0°  
Efficiency 88 %  
Peak intensity 1.6 cd/lm  
LEDs/each optic 1  
Light colour White  
Required components:

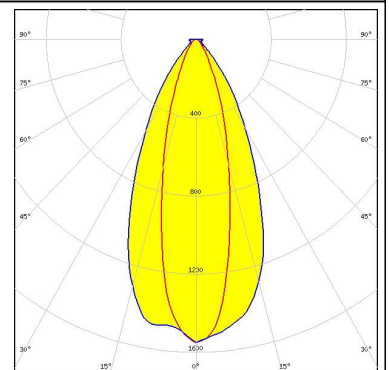

**OSRAM**  
Opto Semiconductors

LED OSCONIQ P 3030  
FWHM 10.0 + 56.0°  
Efficiency 94 %  
Peak intensity 3.5 cd/lm  
LEDs/each optic 1  
Light colour White  
Required components:

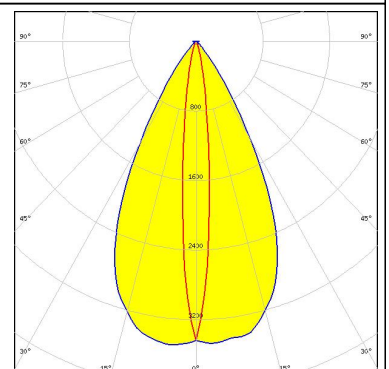

**OSRAM**  
Opto Semiconductors

LED OSCONIQ P 3737 (2W version)  
FWHM 13.0 + 56.0°  
Efficiency 93 %  
Peak intensity 2.9 cd/lm  
LEDs/each optic 1  
Light colour White  
Required components:

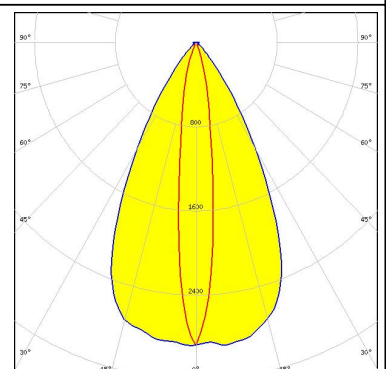

#### PHOTOMETRIC DATA (SIMULATED):

**OSRAM**  
Opto Semiconductors

LED OSCONIQ P 3737 Flat  
 FWHM 16.0 + 54.0°  
 Efficiency 92 %  
 Peak intensity 2.6 cd/lm  
 LEDs/each optic 1  
 Light colour White  
 Required components:

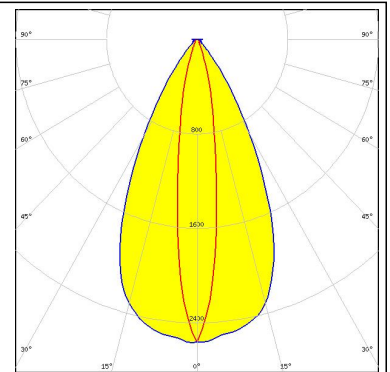

**SEOUL**  
SEOUL SEMICONDUCTOR

LED SEOUL DC 5050 6V  
 FWHM 26.0 + 50.0°  
 Efficiency 90 %  
 Peak intensity 1.6 cd/lm  
 LEDs/each optic 1  
 Light colour White  
 Required components:

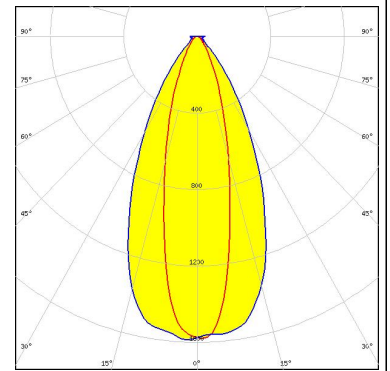

**SEOUL**  
SEOUL SEMICONDUCTOR

LED Z8Y22T  
 FWHM 16.0 + 52.0°  
 Efficiency 90 %  
 Peak intensity 2.5 cd/lm  
 LEDs/each optic 1  
 Light colour White  
 Required components:

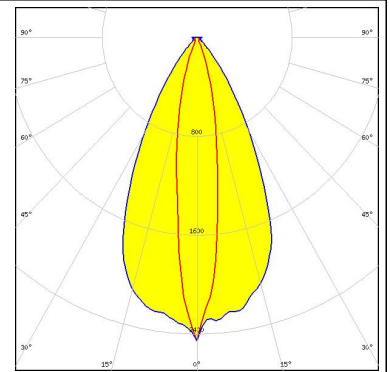

### GENERAL INFORMATION:

NOTE: The typical beam angle will be changed by different color, chip size and chip position tolerance. The typical total beam angle is the full angle measured where the luminous intensity is half of the peak value.

### MATERIALS:

As part of our continuous research and improvement processes, and to ensure the best possible quality and availability of our products, LEDiL reserves the right to change material grades without notice.

### PRODUCT DATA USER AGREEMENT AND DISCLAIMER:

The measured data in the provided downloadable LEDiL Product Datasheets and Mechanical 2D-Drawings is rounded and provided as reference for planning. LEDiL Oy's optical specifications have been verified by conducting performance testing of the products in accordance with the company's quality system. The reported data are averaged results of multiple measurements with typical variation. LEDiL Oy reserves the right to without prior notification make changes and improvements to its products.

LEDiL Oy assumes neither warranty, nor guarantee nor any other liability of any kind for the contents and correctness of the provided data. The provided data has been generated with highest diligence but the provided data may in reality not represent the complete possible variation range of all intrinsic parameters. Therefore, in certain cases a deviation from the provided data could occur.

LEDiL Oy reserves the right to undertake technical changes of its products without further notification which could lead to changes in the provided data. LEDiL Oy assumes no liability of any kind for the possible deviation from any provided data or any other damage resulting from the usage of the provided data.

The user agrees to this disclaimer and user agreement with the download or usage of the provided files.

#### LEDiL Oy

Joensuunkatu 13  
FI-24240 SALO  
Finland

#### LEDiL Inc.

228 West Page Street  
Suite D  
Sycamore IL 60178  
USA

#### Local sales and technical support

[www.ledil.com/  
where\\_to\\_buy](http://www.ledil.com/where_to_buy)

#### Shipping locations

Salo, Finland  
Hong Kong, China

#### Distribution Partners

[www.ledil.com/  
where\\_to\\_buy](http://www.ledil.com/where_to_buy)



## Стандарт Электрон Связь

Мы молодая и активно развивающаяся компания в области поставок электронных компонентов. Мы поставляем электронные компоненты отечественного и импортного производства напрямую от производителей и с крупнейших складов мира.

Благодаря сотрудничеству с мировыми поставщиками мы осуществляем комплексные и плановые поставки широчайшего спектра электронных компонентов.

Собственная эффективная логистика и склад в обеспечивает надежную поставку продукции в точно указанные сроки по всей России.

Мы осуществляем техническую поддержку нашим клиентам и предпродажную проверку качества продукции. На все поставляемые продукты мы предоставляем гарантию .

Осуществляем поставки продукции под контролем ВП МО РФ на предприятия военно-промышленного комплекса России , а также работаем в рамках 275 ФЗ с открытием отдельных счетов в уполномоченном банке. Система менеджмента качества компании соответствует требованиям ГОСТ ISO 9001.

Минимальные сроки поставки, гибкие цены, неограниченный ассортимент и индивидуальный подход к клиентам являются основой для выстраивания долгосрочного и эффективного сотрудничества с предприятиями радиоэлектронной промышленности, предприятиями ВПК и научно-исследовательскими институтами России.

С нами вы становитесь еще успешнее!

### Наши контакты:

**Телефон:** +7 812 627 14 35

**Электронная почта:** [sales@st-electron.ru](mailto:sales@st-electron.ru)

**Адрес:** 198099, Санкт-Петербург,  
Промышленная ул, дом № 19, литера Н,  
помещение 100-Н Офис 331