

HEIDI-M

~25° medium beam

TECHNICAL SPECIFICATIONS:

Dimensions	Ø 21.6 mm
Height	11.9 mm
Fastening	tape, pin
ROHS compliant	yes 

MATERIAL SPECIFICATIONS:

Component	Type	Material	Colour	Finish
HEIDI-M	Single lens	PMMA		
HEIDI-TAPE	Tape	PU tape		

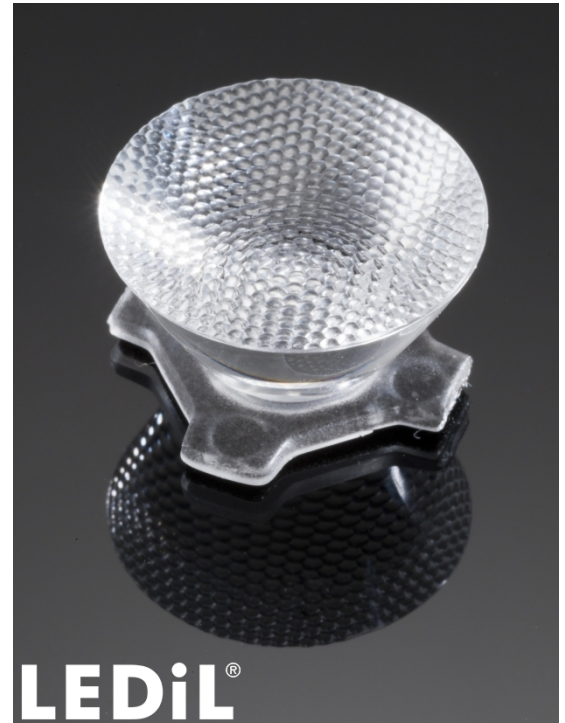

ORDERING INFORMATION:

Component		Qty in box	MOQ	MPQ	Box weight (kg)
CA11265_HEIDI-M	Single lens	3264	204	204	10.8
» Box size: 480 x 280 x 300 mm					

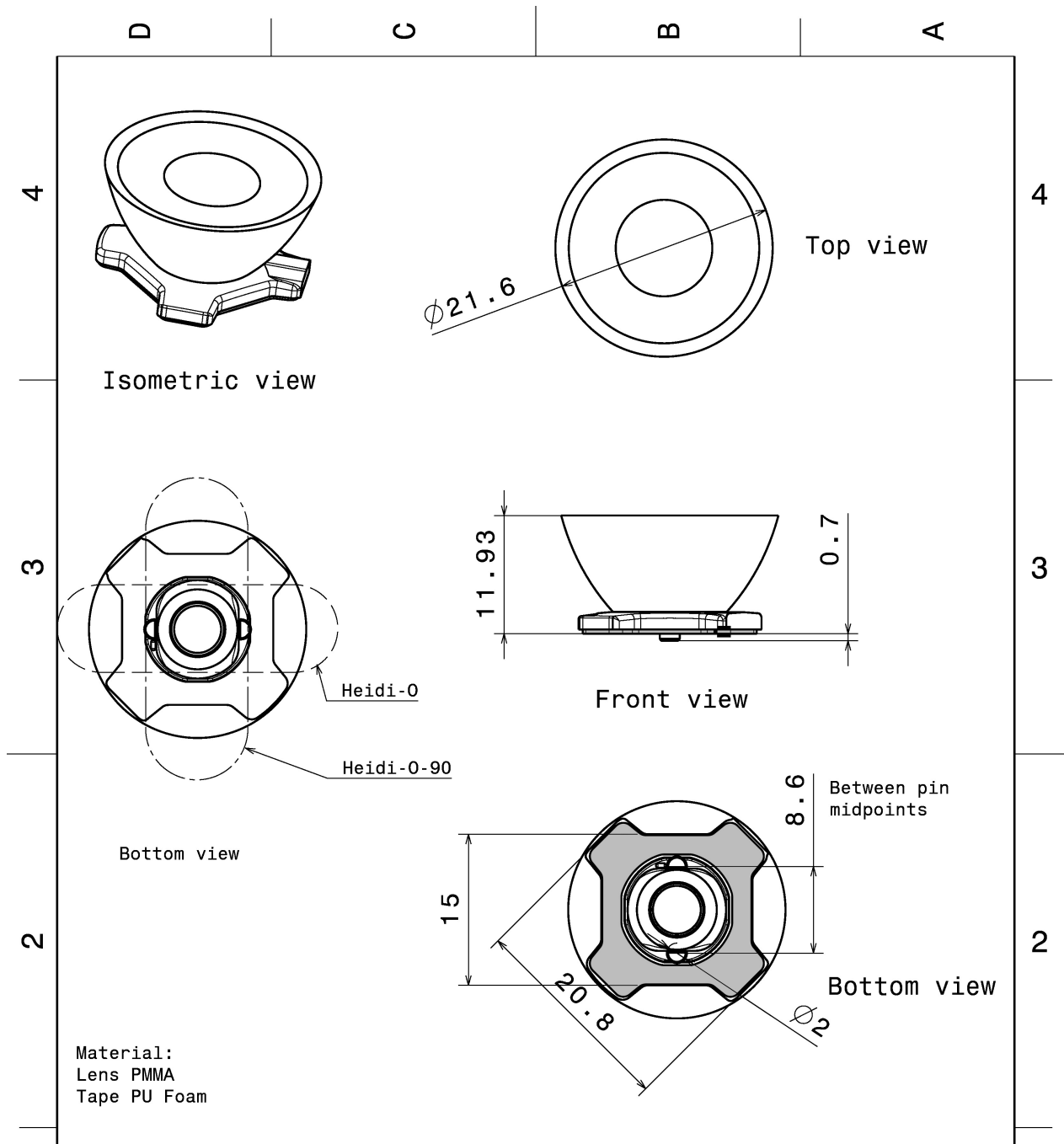

This drawing is our property. It can't be reproduced or communicated without our written agreement.				Ledil Oy Joensuunkatu 13 FIN-24100 SALO Finland	
DRAWN BY ah		DATE 24.6.2013		DRAWING TITLE Datasheet Heidi-0 assy	
CHECKED BY		DATE		SIZE A4	
DESIGNED BY		DATE		DRAWING NUMBER	
		SCALE 2:1		WEIGHT (g)	
				REV 001	
				SHEET 1/1	

PHOTOMETRIC DATA (MEASURED):

CREE

LED XB-D
FWHM 29.0°
Efficiency 87 %
Peak intensity 2.000 cd/lm
LEDs/each optic 1
Light colour White
Required components:

CREE

LED XB-H
FWHM 27.0°
Efficiency 87 %
Peak intensity 3.400 cd/lm
LEDs/each optic 1
Light colour White
Required components:

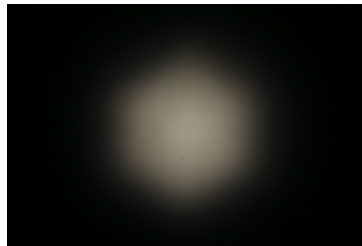

CREE

LED XP-E
FWHM 28.0°
Efficiency 92 %
Peak intensity 2.860 cd/lm
LEDs/each optic 1
Light colour White
Required components:

CREE

LED XP-G
FWHM 28.0°
Efficiency 92 %
Peak intensity 3.300 cd/lm
LEDs/each optic 1
Light colour White
Required components:

PHOTOMETRIC DATA (MEASURED):



LED XQ-E HD
 FWHM 26.0°
 Efficiency 94 %
 Peak intensity 4.100 cd/lm
 LEDs/each optic 1
 Light colour White
 Required components:

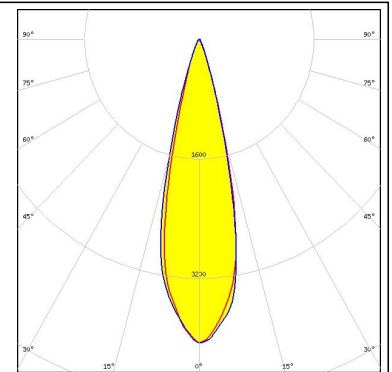

LED XQ-E HI
 FWHM 25.0°
 Efficiency 94 %
 Peak intensity 4.200 cd/lm
 LEDs/each optic 1
 Light colour White
 Required components:

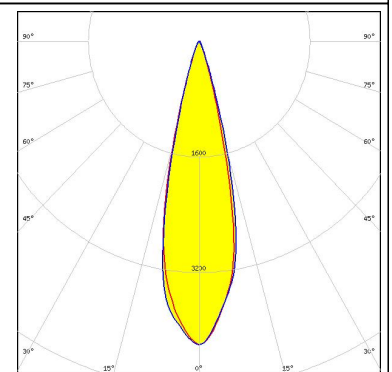
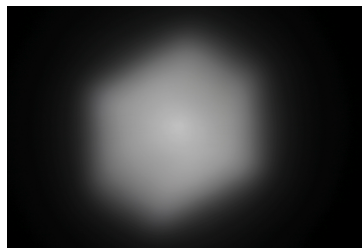

LED LUXEON C
 FWHM 26.0°
 Efficiency 87 %
 Peak intensity 3.950 cd/lm
 LEDs/each optic 1
 Light colour White
 Required components:

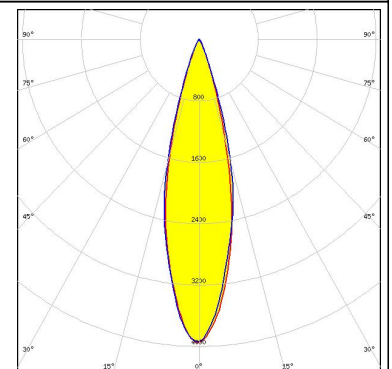
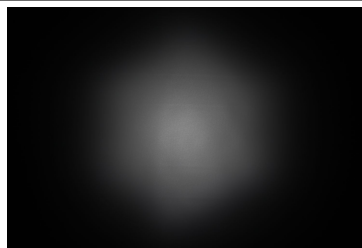

LED LUXEON CZ
 FWHM 26.0°
 Efficiency 94 %
 Peak intensity 4.500 cd/lm
 LEDs/each optic 1
 Light colour White
 Required components:

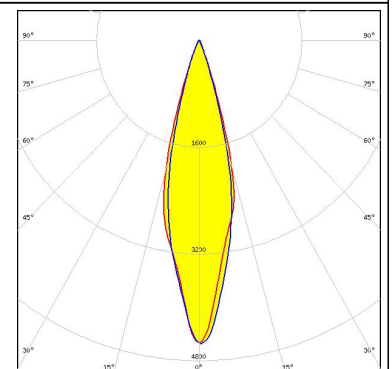
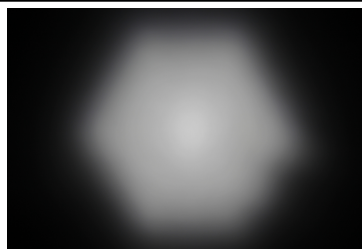

PHOTOMETRIC DATA (MEASURED):

LUMILEDS

LED LUXEON T
 FWHM 28.0°
 Efficiency 87 %
 Peak intensity 3.300 cd/lm
 LEDs/each optic 1
 Light colour White
 Required components:

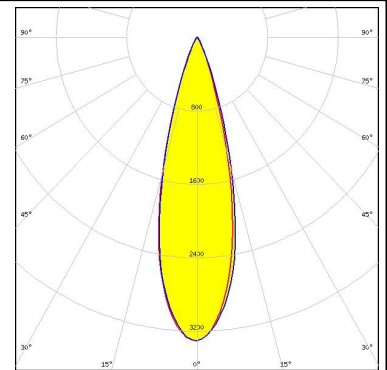
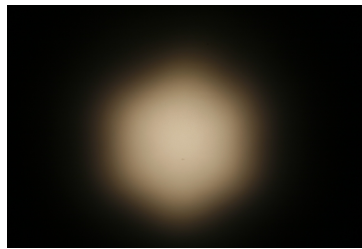

LUMILEDS

LED LUXEON TX
 FWHM 29.0°
 Efficiency 88 %
 Peak intensity 3.400 cd/lm
 LEDs/each optic 1
 Light colour White
 Required components:

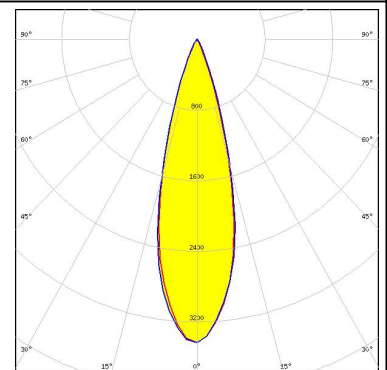
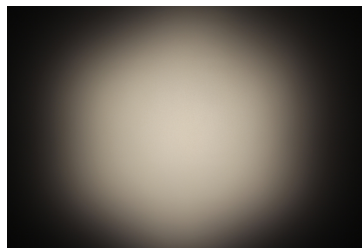

NICHIA

LED NCSxx19A
 FWHM 26.0°
 Efficiency 87 %
 Peak intensity 3.000 cd/lm
 LEDs/each optic 1
 Light colour White
 Required components:



NICHIA

LED NCSxx19B
 FWHM 29.0°
 Efficiency 88 %
 Peak intensity 3.700 cd/lm
 LEDs/each optic 1
 Light colour White
 Required components:

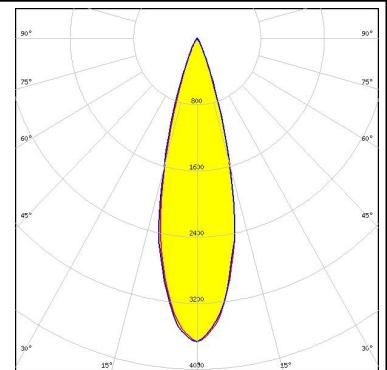

PHOTOMETRIC DATA (MEASURED):



LED NVSxx19A
FWHM 28.0°
Efficiency 87 %
Peak intensity 3.100 cd/lm
LEDs/each optic 1
Light colour White
Required components:



LED NVSxx19B/NVSxx19C
FWHM 28.0°
Efficiency 90 %
Peak intensity 3.300 cd/lm
LEDs/each optic 1
Light colour White
Required components:

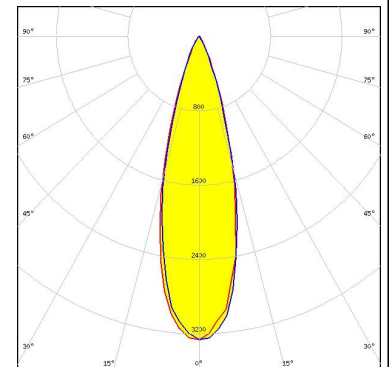

Opto Semiconductors
LED OSOLON SSL 150
FWHM 26.0°
Efficiency 90 %
Peak intensity 3.400 cd/lm
LEDs/each optic 1
Light colour White
Required components:



Opto Semiconductors
LED OSOLON SSL 80
FWHM 28.0°
Efficiency 87 %
Peak intensity 3.130 cd/lm
LEDs/each optic 1
Light colour White
Required components:

PHOTOMETRIC DATA (MEASURED):

PHILIPS

LED Fortimo FastFlex 2x8 DS G3
 FWHM 25.0°
 Efficiency 90 %
 Peak intensity 4.000 cd/lm
 LEDs/each optic 1
 Light colour White
 Required components:

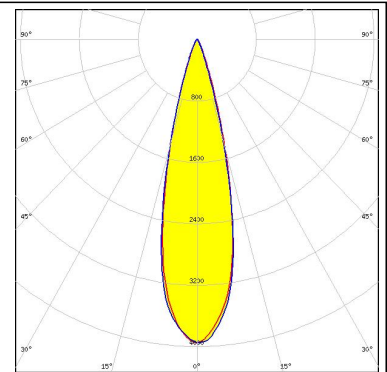

SAMSUNG

LED LH181A
 FWHM 27.0°
 Efficiency 88 %
 Peak intensity 2.900 cd/lm
 LEDs/each optic 1
 Light colour White
 Required components:

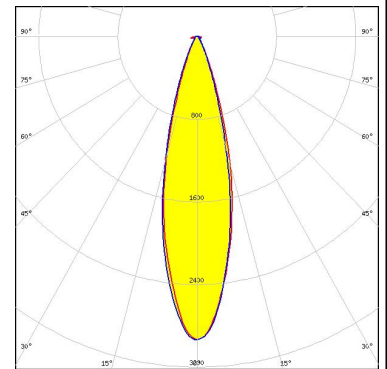
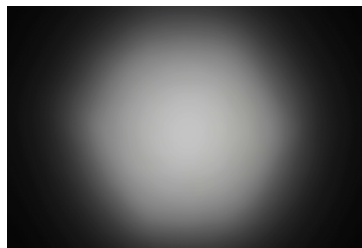

SAMSUNG

LED LH181B
 FWHM 27.0°
 Efficiency 93 %
 Peak intensity 3.400 cd/lm
 LEDs/each optic 1
 Light colour White
 Required components:

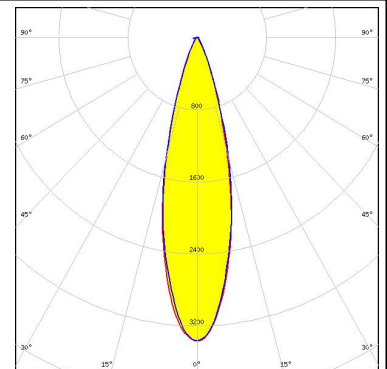
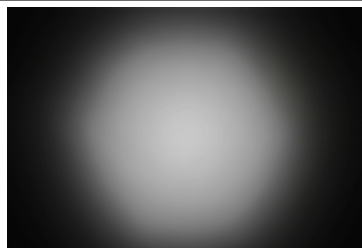

SEOUL SEMICONDUCTOR

LED Z5
 FWHM 28.0°
 Efficiency 87 %
 Peak intensity 3.670 cd/lm
 LEDs/each optic 1
 Light colour White
 Required components:

PHOTOMETRIC DATA (MEASURED):

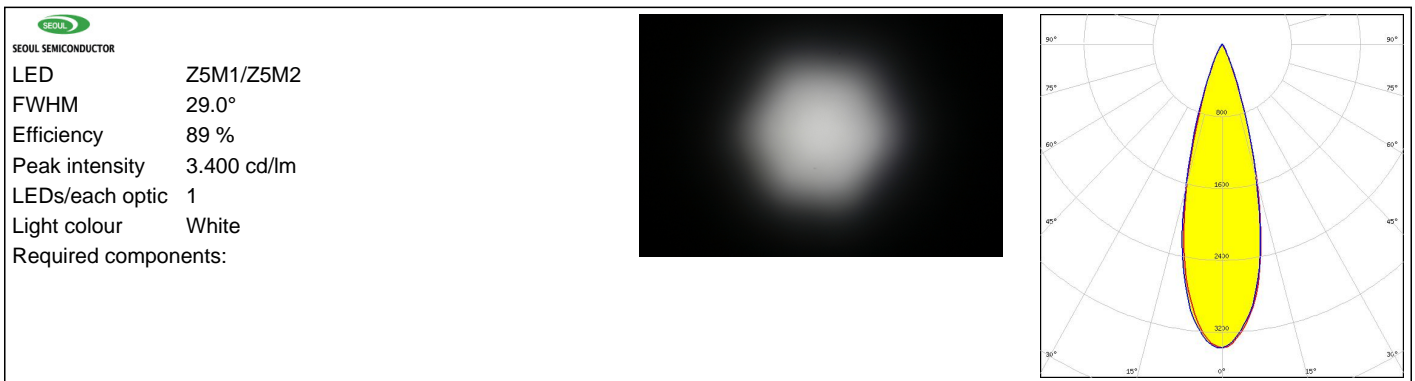

PHOTOMETRIC DATA (SIMULATED):



LED XB-D
 FWHM 28.0°
 Efficiency 93 %
 Peak intensity 3.794 cd/lm
 LEDs/each optic 1
 Light colour White
 Required components:

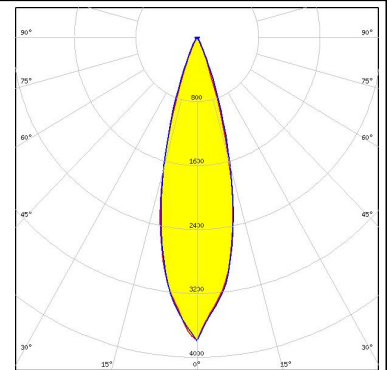

LED XT-E
 FWHM 28.0°
 Efficiency 93 %
 Peak intensity 3.700 cd/lm
 LEDs/each optic 1
 Light colour White
 Required components:

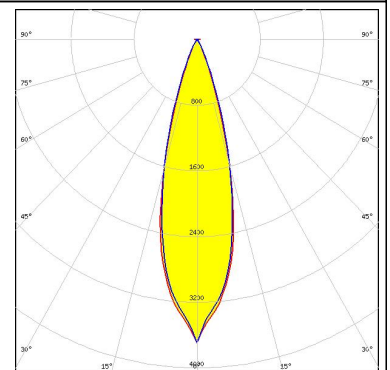

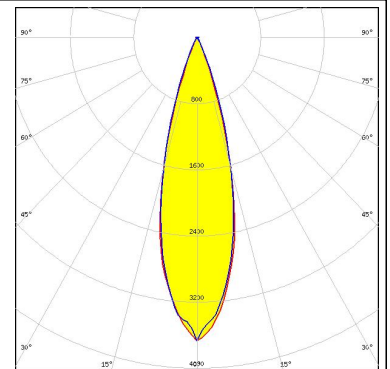

LED LUXEON SunPlus 20 Line (150 deg)
 FWHM 28.0°
 Efficiency 91 %
 Peak intensity 3.670 cd/lm
 LEDs/each optic 1
 Light colour White
 Required components:

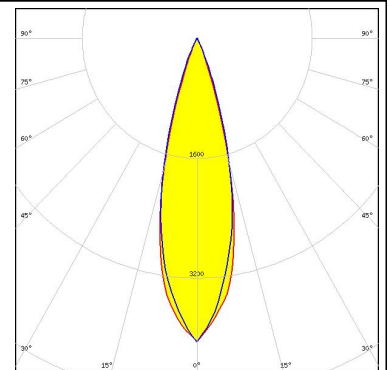

LED LUXEON Z ES
 FWHM 28.0°
 Efficiency 94 %
 Peak intensity 4.050 cd/lm
 LEDs/each optic 1
 Light colour White
 Required components:

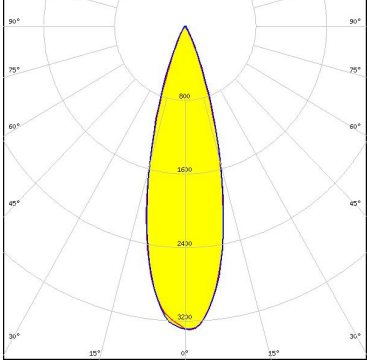
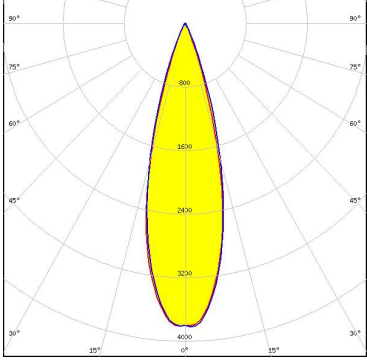
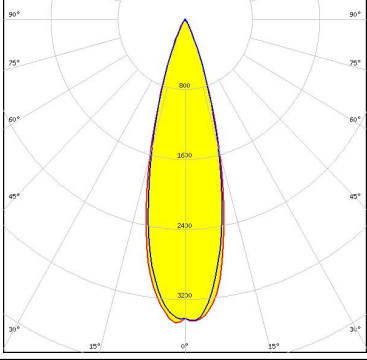

PHOTOMETRIC DATA (SIMULATED):

<p>NICHIA</p> <p>LED NVSxx19B/NVSxx19C FWHM 28.0° Efficiency 94 % Peak intensity 3.321 cd/lm LEDs/each optic 1 Light colour White Required components:</p>	
<p>OSRAM Opto Semiconductors</p> <p>LED OSCONIQ P 3030 FWHM 28.0° Efficiency 96 % Peak intensity 3.841 cd/lm LEDs/each optic 1 Light colour White Required components:</p>	
<p>OSRAM Opto Semiconductors</p> <p>LED OSLON Square CSSRM2/CSSRM3 FWHM 28.0° Efficiency 94 % Peak intensity 3.500 cd/lm LEDs/each optic 1 Light colour White Required components:</p>	
<p>OSRAM Opto Semiconductors</p> <p>LED OSLON Square EC FWHM 29.0° Efficiency % Peak intensity 3.200 cd/lm LEDs/each optic 1 Light colour White Required components:</p>	

PHOTOMETRIC DATA (SIMULATED):

OSRAM
Opto Semiconductors

LED	OSLON SSL 80
FWHM	29.0°
Efficiency	96 %
Peak intensity	3.696 cd/lm
LEDs/each optic	1
Light colour	White
Required components:	

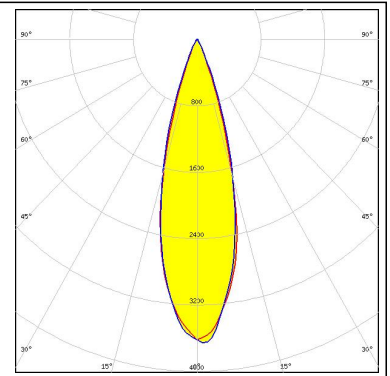

GENERAL INFORMATION:

NOTE: The typical beam angle will be changed by different color, chip size and chip position tolerance. The typical total beam angle is the full angle measured where the luminous intensity is half of the peak value.

MATERIALS:

As part of our continuous research and improvement processes, and to ensure the best possible quality and availability of our products, LEDiL reserves the right to change material grades without notice.

PRODUCT DATA USER AGREEMENT AND DISCLAIMER:

The measured data in the provided downloadable LEDiL Product Datasheets and Mechanical 2D-Drawings is rounded and provided as reference for planning. LEDiL Oy's optical specifications have been verified by conducting performance testing of the products in accordance with the company's quality system. The reported data are averaged results of multiple measurements with typical variation. LEDiL Oy reserves the right to without prior notification make changes and improvements to its products.

LEDiL Oy assumes neither warranty, nor guarantee nor any other liability of any kind for the contents and correctness of the provided data. The provided data has been generated with highest diligence but the provided data may in reality not represent the complete possible variation range of all intrinsic parameters. Therefore, in certain cases a deviation from the provided data could occur.

LEDiL Oy reserves the right to undertake technical changes of its products without further notification which could lead to changes in the provided data. LEDiL Oy assumes no liability of any kind for the possible deviation from any provided data or any other damage resulting from the usage of the provided data.

The user agrees to this disclaimer and user agreement with the download or usage of the provided files.

LEDiL Oy

Joensuunkatu 13
FI-24240 SALO
Finland

LEDiL Inc.

228 West Page Street
Suite D
Sycamore IL 60178
USA

Local sales and technical support

[www.ledil.com/
where_to_buy](http://www.ledil.com/where_to_buy)

Shipping locations

Salo, Finland
Hong Kong, China

Distribution Partners

[www.ledil.com/
where_to_buy](http://www.ledil.com/where_to_buy)



Стандарт Электрон Связь

Мы молодая и активно развивающаяся компания в области поставок электронных компонентов. Мы поставляем электронные компоненты отечественного и импортного производства напрямую от производителей и с крупнейших складов мира.

Благодаря сотрудничеству с мировыми поставщиками мы осуществляем комплексные и плановые поставки широчайшего спектра электронных компонентов.

Собственная эффективная логистика и склад в обеспечивает надежную поставку продукции в точно указанные сроки по всей России.

Мы осуществляем техническую поддержку нашим клиентам и предпродажную проверку качества продукции. На все поставляемые продукты мы предоставляем гарантию .

Осуществляем поставки продукции под контролем ВП МО РФ на предприятия военно-промышленного комплекса России , а также работаем в рамках 275 ФЗ с открытием отдельных счетов в уполномоченном банке. Система менеджмента качества компании соответствует требованиям ГОСТ ISO 9001.

Минимальные сроки поставки, гибкие цены, неограниченный ассортимент и индивидуальный подход к клиентам являются основой для выстраивания долгосрочного и эффективного сотрудничества с предприятиями радиоэлектронной промышленности, предприятиями ВПК и научно-исследовательскими институтами России.

С нами вы становитесь еще успешнее!

Наши контакты:

Телефон: +7 812 627 14 35

Электронная почта: sales@st-electron.ru

Адрес: 198099, Санкт-Петербург,
Промышленная ул, дом № 19, литера Н,
помещение 100-Н Офис 331