

SERIES: SDI30-UD | DESCRIPTION: AC-DC POWER SUPPLY
FEATURES

- up to 30 W continuous power
- DoE Level VI, CoC Tier 2 efficiency
- universal input voltage range
- compact size
- no load power consumption < 0.075 W
- over voltage and short circuit protections
- UL/cUL, GS, and PSE safety approvals
- custom designs available



| MODEL | output voltage | output current max | output power max | ripple and noise ¹ max | efficiency level ² |
|-------------|----------------|--------------------|------------------|-----------------------------------|-------------------------------|
| | (Vdc) | (A) | (W) | (mVp-p) | |
| SDI30-12-UD | 12 | 2.5 | 30 | 200 | VI |
| SDI30-15-UD | 15 | 2 | 30 | 200 | VI |
| SDI30-19-UD | 19 | 1.6 | 30 | 300 | VI |
| SDI30-24-UD | 24 | 1.25 | 30 | 300 | VI |

Notes: 1. Measured at 100~240 Vac input, full load, 20 MHz bandwidth oscilloscope, output terminated with a 10 μ F aluminum electrolytic and 0.1 μ F ceramic capacitor.
2. CoC Tier 2 compliant

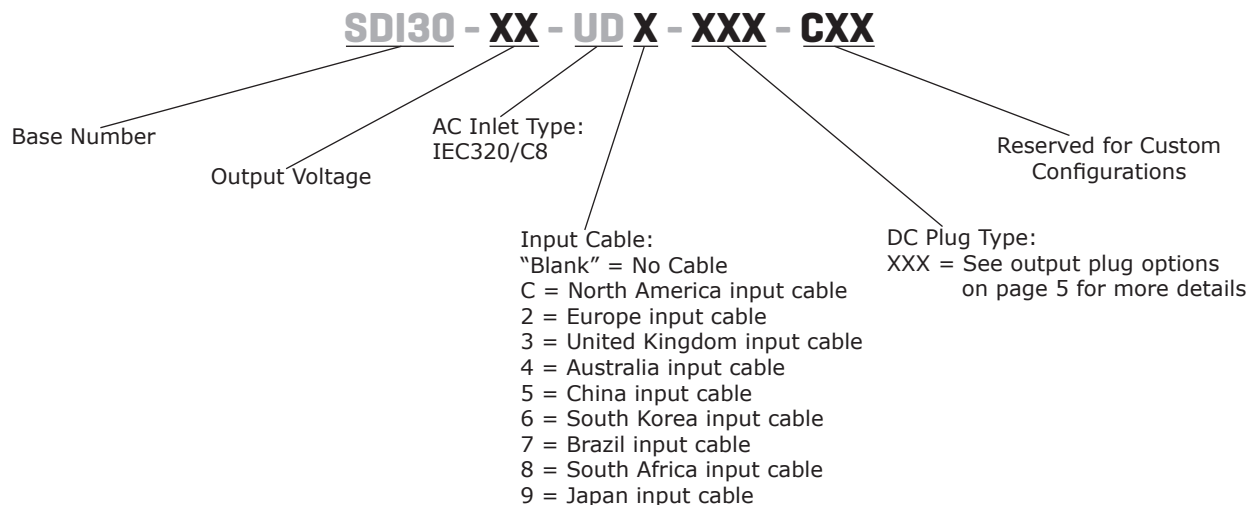
PART NUMBER KEY

INPUT

| parameter | conditions/description | min | typ | max | units |
|---------------------------|------------------------|-----|-----|-------|-------|
| voltage | | 90 | | 264 | Vac |
| frequency | | 47 | | 63 | Hz |
| current | | | | 1 | A |
| leakage current | | | | 0.25 | mA |
| no load power consumption | | | | 0.075 | W |

OUTPUT

| parameter | conditions/description | min | typ | max | units |
|-----------------|------------------------|-----|-----|-----|-------|
| load regulation | | | ±5 | | % |

PROTECTIONS

| parameter | conditions/description | min | typ | max | units |
|--------------------------|---------------------------------|-----|-----|-----|-------|
| over voltage protection | 12 Vdc output model | | | 16 | Vdc |
| | 15 Vdc output model | | | 22 | Vdc |
| | 19 Vdc output model | | | 27 | Vdc |
| | 24 Vdc output model | | | 32 | Vdc |
| over current protection | 12 Vdc output model | | | 4 | A |
| | 15 Vdc output model | | | 4 | A |
| | 19 Vdc output model | | | 4 | A |
| | 24 Vdc output model | | | 2.8 | A |
| short circuit protection | output shut down, auto recovery | | | | |

SAFETY & COMPLIANCE

| parameter | conditions/description | min | typ | max | units |
|----------------------|---------------------------------------|-----|----------------|-----|------------|
| isolation voltage | input to output at 10 mA for 1 minute | | 3,000 4,242 | | Vac Vdc |
| isolation resistance | input to output at 500 Vdc | 100 | | | MΩ |
| safety approvals | UL/cUL, GS, PSE | | | | |
| EMI/EMC | FCC Part 15B Class B, CE | | | | |
| RoHS | 2011/65/EU | | | | |

ENVIRONMENTAL

| parameter | conditions/description | min | typ | max | units |
|-----------------------|------------------------|-----|-----|-----|-------|
| operating temperature | | 0 | | 40 | °C |
| storage temperature | | -10 | | 70 | °C |
| operating humidity | non-condensing | 20 | | 80 | % |
| storage humidity | non-condensing | 10 | | 90 | % |

MECHANICAL

| parameter | conditions/description | min | typ | max | units |
|------------|------------------------|-----|-----|-----|-------|
| dimensions | 111 x 52 x 32.3 | | | | mm |
| inlet plug | IEC320/C8 | | | | |
| weight | without AC cord | | 240 | | g |
| | with AC cord | | 270 | | g |

MECHANICAL DRAWING

units: mm

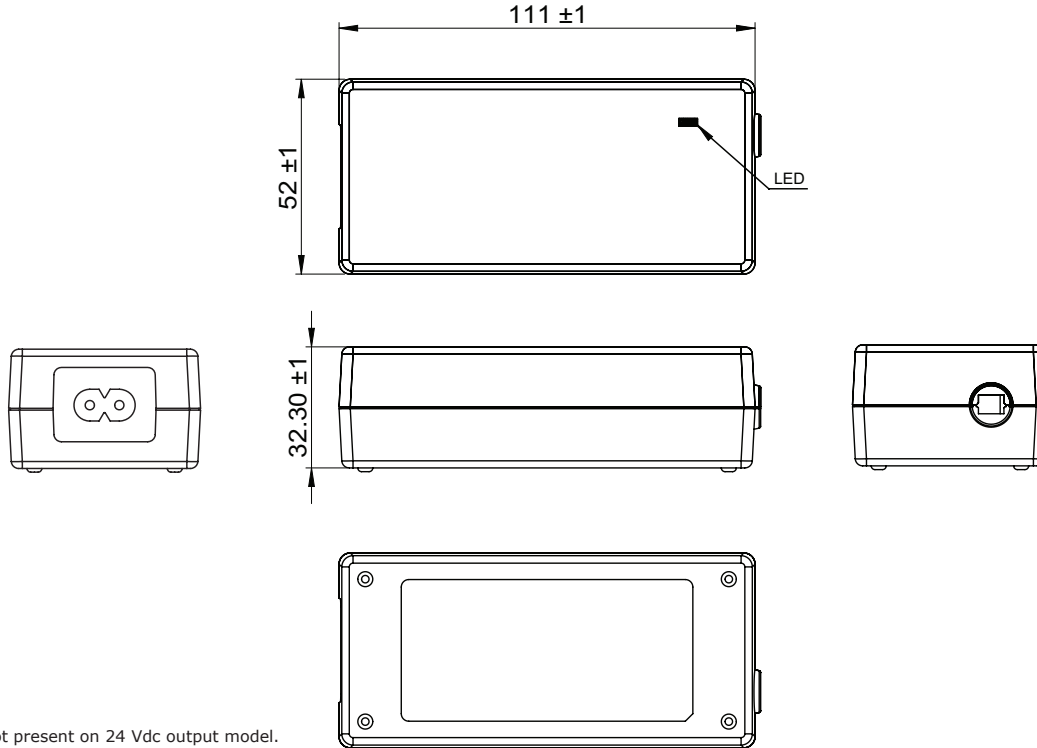

Note: 1. LED indicator is not present on 24 Vdc output model.

DC CORD

units: mm

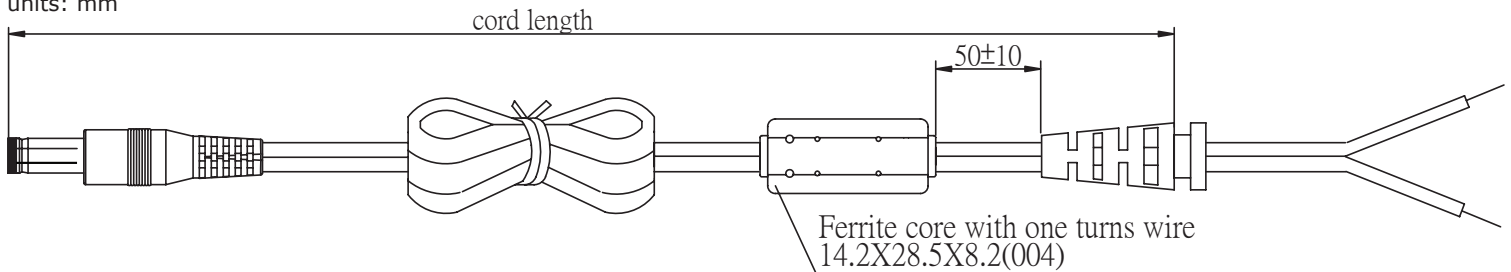

Table 1

| MODEL NO. | CABLE | CORD LENGTH |
|-------------|----------------|---------------|
| SDI30-12-UD | UL2468, 16 AWG | 1,530 mm ±100 |
| SDI30-15-UD | UL2468, 18 AWG | 1,530 mm ±100 |
| SDI30-19-UD | UL2468, 20 AWG | 1,530 mm ±100 |
| SDI30-24-UD | UL2468, 20 AWG | 1,530 mm ±100 |

AC CORD

units: mm



NORTH AMERICA



EUROPE



UNITED KINGDOM



AUSTRALIA



CHINA



SOUTH KOREA



BRAZIL



SOUTH AFRICA



JAPAN



Table 2

| AC INPUT | CORD LENGTH |
|----------------|--------------|
| North America | 1,830 mm ±30 |
| Europe | 1,830 mm ±30 |
| United Kingdom | 1,830 mm ±30 |
| Australia | 1,830 mm ±30 |
| China | 1,830 mm ±30 |
| South Korea | 1,830 mm ±30 |
| Brazil | 1,830 mm ±30 |
| South Africa | 1,830 mm ±30 |
| Japan | 1,830 mm ±30 |

DC PLUG TYPE PART NUMBER KEY

XXX

Plug Polarity:
 P = Center Positive

 N = Center Negative

Plug Code:
 X = Choose a code from the options below

Plug Angle:
 "blank" = Straight
 R = Right Angle

| Plug Polarity | | Code | | Dimensions (mm) | | | Plug Angle | |
|---------------|-------------|--------|-------------------|-----------------|------|-----|------------|-------|
| Center Pos. | Center Neg. | Option | Type | A | B | C | Straight | Right |
| • | • | 5 | Standard | 5.5 | 2.1 | 9.5 | • | • |
| • | • | 6 | Standard | 5.5 | 2.5 | 9.5 | • | • |
| • | • | 7 | Standard | 3.5 | 1.35 | 9.5 | • | • |
| • | • | 8 | Standard | 3.8 | 1.35 | 9.5 | • | • |
| • | • | 9 | Standard | 3.8 | 1.05 | 9.5 | • | • |
| • | • | 10 | Locking | 5.5 | 2.1 | 9.5 | • | N/A |
| • | • | 11 | Locking | 5.5 | 2.5 | 9.5 | • | N/A |
| • | • | 12 | EIAJ-1 | 2.35 | 0.7 | 9.5 | • | • |
| • | • | 13 | EIAJ-2 | 4.0 | 1.7 | 9.5 | • | • |
| • | • | 14 | EIAJ-3 | 4.75 | 1.7 | 9.5 | • | • |
| N/A | N/A | ST | Stripped & Tinned | | | N/A | N/A | N/A |

Note: 1. Contact CUI for additional plug options

Standard

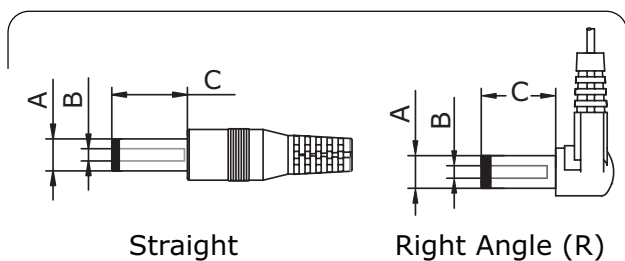

EIAJ

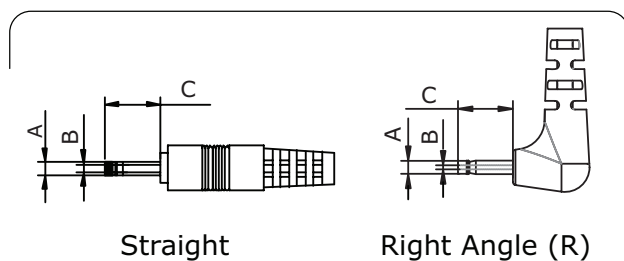

Locking

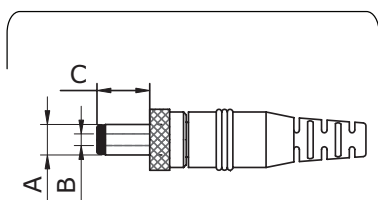

Stripped & Tinned

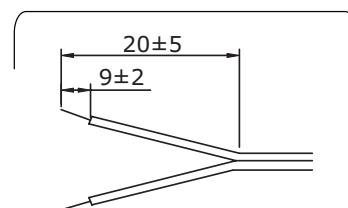

REVISION HISTORY

| rev. | description | date |
|------|-------------------|------------|
| 1.0 | initial release | 11/15/2016 |
| 1.01 | updated datasheet | 03/14/2018 |

The revision history provided is for informational purposes only and is believed to be accurate.



Headquarters
20050 SW 112th Ave.
Tualatin, OR 97062
800.275.4899

Fax 503.612.2383
cui.com
techsupport@cui.com

This device complies with part 15 of the FCC Rules. Operation is subject to the following two conditions:

- (1) This device may not cause harmful interference, and
- (2) this device must accept any interference received, including interference that may cause undesired operation.

CUI offers a one (1) year limited warranty. Complete warranty information is listed on our website.

CUI reserves the right to make changes to the product at any time without notice. Information provided by CUI is believed to be accurate and reliable. However, no responsibility is assumed by CUI for its use, nor for any infringements of patents or other rights of third parties which may result from its use.

CUI products are not authorized or warranted for use as critical components in equipment that requires an extremely high level of reliability. A critical component is any component of a life support device or system whose failure to perform can be reasonably expected to cause the failure of the life support device or system, or to affect its safety or effectiveness.



Стандарт Электрон Связь

Мы молодая и активно развивающаяся компания в области поставок электронных компонентов. Мы поставляем электронные компоненты отечественного и импортного производства напрямую от производителей и с крупнейших складов мира.

Благодаря сотрудничеству с мировыми поставщиками мы осуществляем комплексные и плановые поставки широчайшего спектра электронных компонентов.

Собственная эффективная логистика и склад в обеспечивает надежную поставку продукции в точно указанные сроки по всей России.

Мы осуществляем техническую поддержку нашим клиентам и предпродажную проверку качества продукции. На все поставляемые продукты мы предоставляем гарантию .

Осуществляем поставки продукции под контролем ВП МО РФ на предприятия военно-промышленного комплекса России , а также работаем в рамках 275 ФЗ с открытием отдельных счетов в уполномоченном банке. Система менеджмента качества компании соответствует требованиям ГОСТ ISO 9001.

Минимальные сроки поставки, гибкие цены, неограниченный ассортимент и индивидуальный подход к клиентам являются основой для выстраивания долгосрочного и эффективного сотрудничества с предприятиями радиоэлектронной промышленности, предприятиями ВПК и научно-исследовательскими институтами России.

С нами вы становитесь еще успешнее!

Наши контакты:

Телефон: +7 812 627 14 35

Электронная почта: sales@st-electron.ru

Адрес: 198099, Санкт-Петербург,
Промышленная ул, дом № 19, литера Н,
помещение 100-Н Офис 331