

SERIES: SDI30-UD | DESCRIPTION: AC-DC POWER SUPPLY
FEATURES

- up to 30 W continuous power
- DoE Level VI, CoC Tier 2 efficiency
- universal input voltage range
- compact size
- no load power consumption < 0.075 W
- over voltage and short circuit protections
- UL/cUL, GS, and PSE safety approvals
- custom designs available



MODEL	output voltage	output current max	output power max	ripple and noise ¹ max	efficiency level ²
	(Vdc)	(A)	(W)	(mVp-p)	
SDI30-12-UD	12	2.5	30	200	VI
SDI30-15-UD	15	2	30	200	VI
SDI30-19-UD	19	1.6	30	300	VI
SDI30-24-UD	24	1.25	30	300	VI

Notes: 1. Measured at 100~240 Vac input, full load, 20 MHz bandwidth oscilloscope, output terminated with a 10 μ F aluminum electrolytic and 0.1 μ F ceramic capacitor.
2. CoC Tier 2 compliant

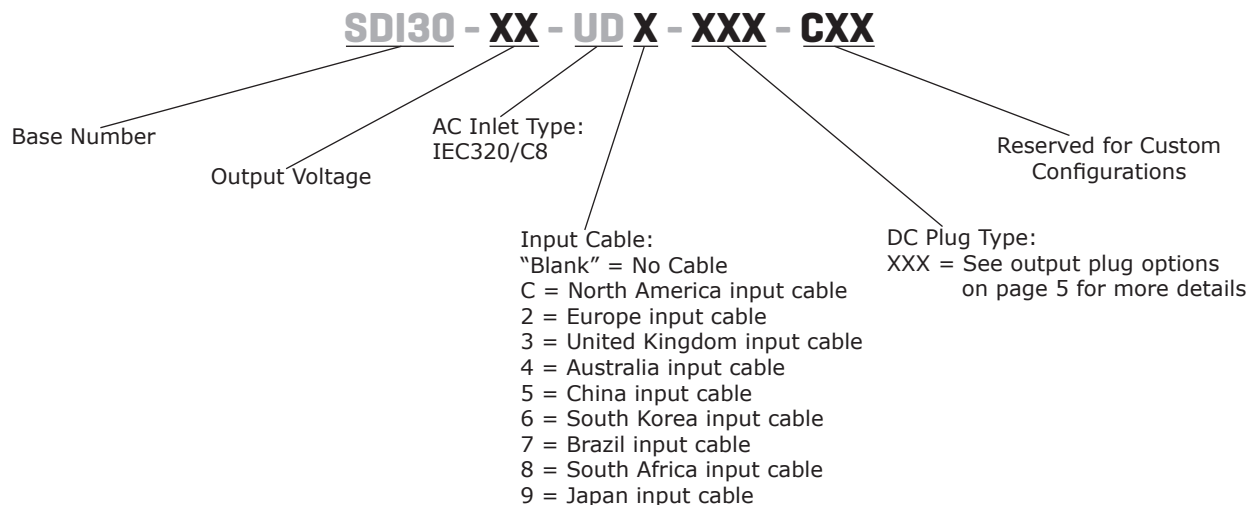
PART NUMBER KEY

INPUT

parameter	conditions/description	min	typ	max	units
voltage		90		264	Vac
frequency		47		63	Hz
current				1	A
leakage current				0.25	mA
no load power consumption				0.075	W

OUTPUT

parameter	conditions/description	min	typ	max	units
load regulation			±5		%

PROTECTIONS

parameter	conditions/description	min	typ	max	units
over voltage protection	12 Vdc output model			16	Vdc
	15 Vdc output model			22	Vdc
	19 Vdc output model			27	Vdc
	24 Vdc output model			32	Vdc
over current protection	12 Vdc output model			4	A
	15 Vdc output model			4	A
	19 Vdc output model			4	A
	24 Vdc output model			2.8	A
short circuit protection	output shut down, auto recovery				

SAFETY & COMPLIANCE

parameter	conditions/description	min	typ	max	units
isolation voltage	input to output at 10 mA for 1 minute		3,000		Vac
			4,242		Vdc
isolation resistance	input to output at 500 Vdc	100			MΩ
safety approvals	UL/cUL, GS, PSE				
EMI/EMC	FCC Part 15B Class B, CE				
RoHS	2011/65/EU				

ENVIRONMENTAL

parameter	conditions/description	min	typ	max	units
operating temperature		0		40	°C
storage temperature		-10		70	°C
operating humidity	non-condensing	20		80	%
storage humidity	non-condensing	10		90	%

MECHANICAL

parameter	conditions/description	min	typ	max	units
dimensions	111 x 52 x 32.3				mm
inlet plug	IEC320/C8				
weight	without AC cord		240		g
	with AC cord		270		g

MECHANICAL DRAWING

units: mm

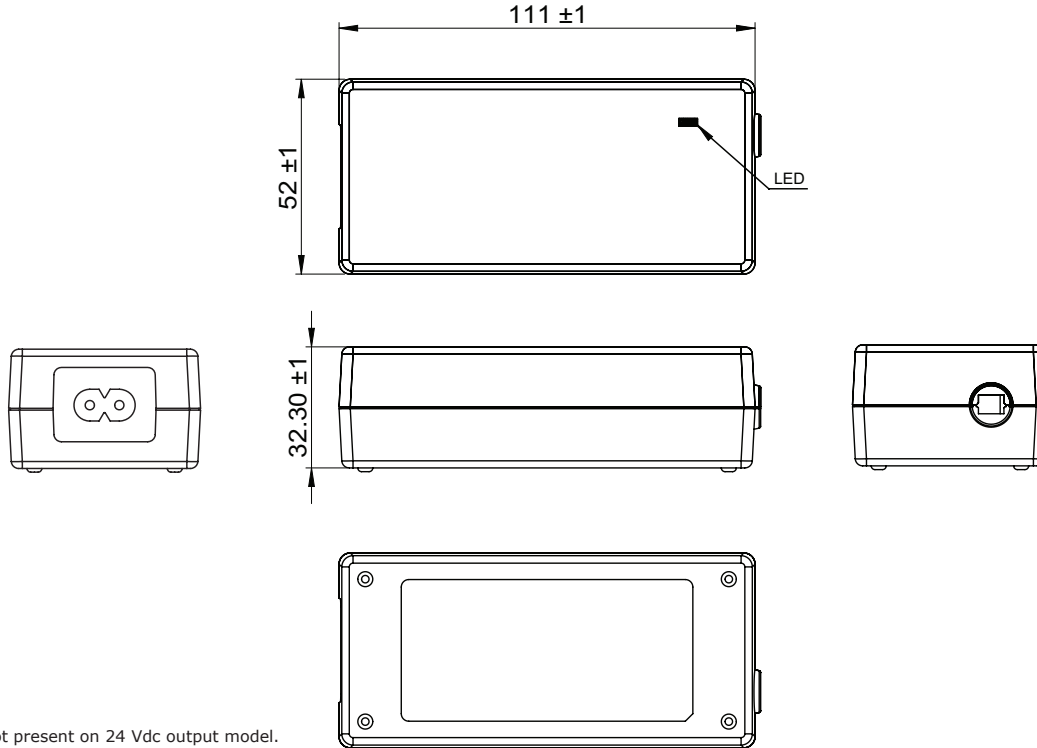

DC CORD

units: mm

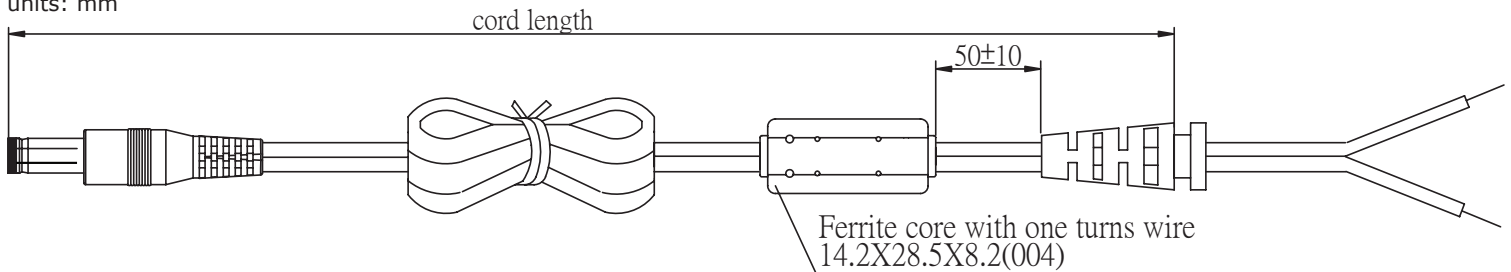

Table 1

MODEL NO.	CABLE	CORD LENGTH
SDI30-12-UD	UL2468, 16 AWG	1,530 mm ±100
SDI30-15-UD	UL2468, 18 AWG	1,530 mm ±100
SDI30-19-UD	UL2468, 20 AWG	1,530 mm ±100
SDI30-24-UD	UL2468, 20 AWG	1,530 mm ±100

AC CORD

units: mm



NORTH AMERICA



EUROPE



UNITED KINGDOM

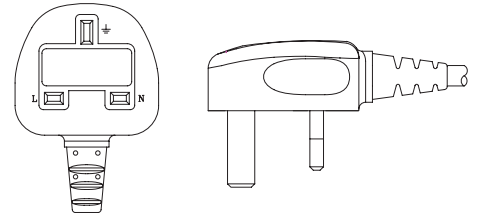

AUSTRALIA



CHINA

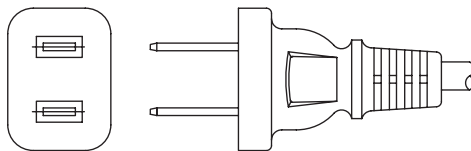

SOUTH KOREA



BRAZIL



SOUTH AFRICA



JAPAN

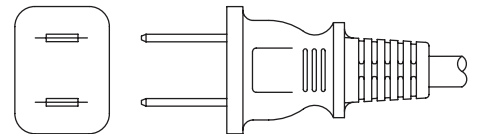
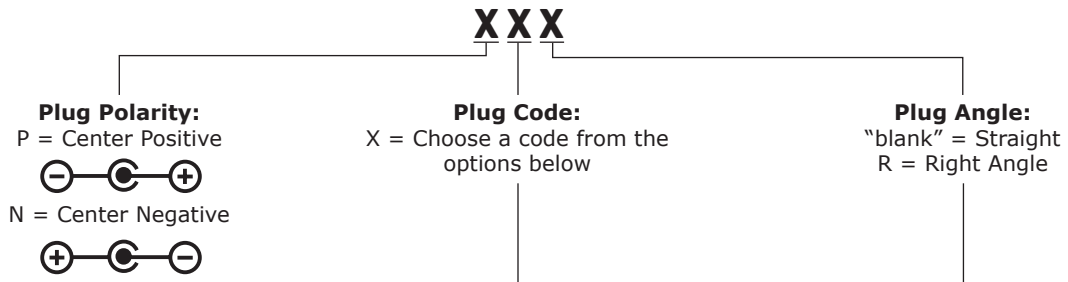

Table 2

AC INPUT	CORD LENGTH
North America	1,830 mm ±30
Europe	1,830 mm ±30
United Kingdom	1,830 mm ±30
Australia	1,830 mm ±30
China	1,830 mm ±30
South Korea	1,830 mm ±30
Brazil	1,830 mm ±30
South Africa	1,830 mm ±30
Japan	1,830 mm ±30

DC PLUG TYPE PART NUMBER KEY



Plug Polarity		Code		Dimensions (mm)			Plug Angle	
Center Pos.	Center Neg.	Option	Type	A	B	C	Straight	Right
•		5	Standard	5.5	2.1	9.5	•	•
•		6	Standard	5.5	2.5	9.5	•	•
•		7	Standard	3.5	1.35	9.5	•	•
•		8	Standard	3.8	1.35	9.5	•	•
•		9	Standard	3.8	1.05	9.5	•	•
•		10	Locking	5.5	2.1	9.5	•	N/A
•		11	Locking	5.5	2.5	9.5	•	N/A
•		12	EIAJ-1	2.35	0.7	9.5	•	•
•		13	EIAJ-2	4.0	1.7	9.5	•	•
•		14	EIAJ-3	4.75	1.7	9.5	•	•
N/A	N/A	ST	Stripped & Tinned			N/A	N/A	

Note: 1. Contact CUI for additional plug options

Standard

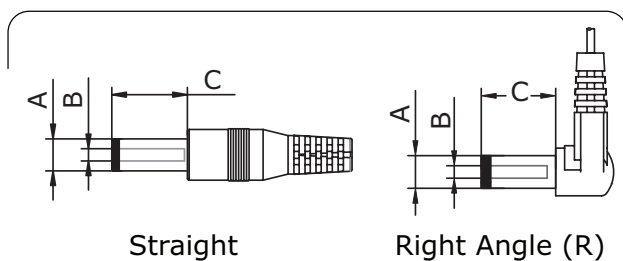

EIAJ

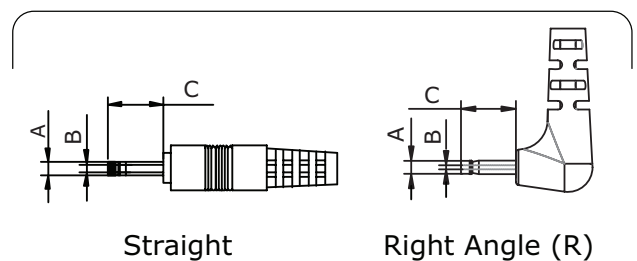

Locking

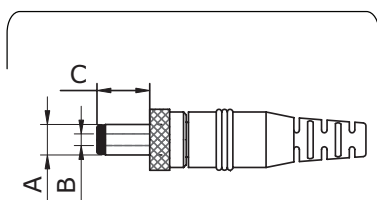

Stripped & Tinned

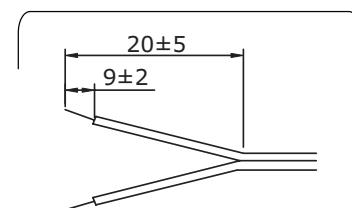

REVISION HISTORY

rev.	description	date
1.0	initial release	11/15/2016
1.01	updated datasheet	03/14/2018

The revision history provided is for informational purposes only and is believed to be accurate.



Headquarters
20050 SW 112th Ave.
Tualatin, OR 97062
800.275.4899

Fax 503.612.2383
cui.com
techsupport@cui.com

This device complies with part 15 of the FCC Rules. Operation is subject to the following two conditions:

- (1) This device may not cause harmful interference, and
- (2) this device must accept any interference received, including interference that may cause undesired operation.

CUI offers a one (1) year limited warranty. Complete warranty information is listed on our website.

CUI reserves the right to make changes to the product at any time without notice. Information provided by CUI is believed to be accurate and reliable. However, no responsibility is assumed by CUI for its use, nor for any infringements of patents or other rights of third parties which may result from its use.

CUI products are not authorized or warranted for use as critical components in equipment that requires an extremely high level of reliability. A critical component is any component of a life support device or system whose failure to perform can be reasonably expected to cause the failure of the life support device or system, or to affect its safety or effectiveness.



Стандарт Электрон Связь

Мы молодая и активно развивающаяся компания в области поставок электронных компонентов. Мы поставляем электронные компоненты отечественного и импортного производства напрямую от производителей и с крупнейших складов мира.

Благодаря сотрудничеству с мировыми поставщиками мы осуществляем комплексные и плановые поставки широчайшего спектра электронных компонентов.

Собственная эффективная логистика и склад в обеспечивает надежную поставку продукции в точно указанные сроки по всей России.

Мы осуществляем техническую поддержку нашим клиентам и предпродажную проверку качества продукции. На все поставляемые продукты мы предоставляем гарантию .

Осуществляем поставки продукции под контролем ВП МО РФ на предприятия военно-промышленного комплекса России , а также работаем в рамках 275 ФЗ с открытием отдельных счетов в уполномоченном банке. Система менеджмента качества компании соответствует требованиям ГОСТ ISO 9001.

Минимальные сроки поставки, гибкие цены, неограниченный ассортимент и индивидуальный подход к клиентам являются основой для выстраивания долгосрочного и эффективного сотрудничества с предприятиями радиоэлектронной промышленности, предприятиями ВПК и научно-исследовательскими институтами России.

С нами вы становитесь еще успешнее!

Наши контакты:

Телефон: +7 812 627 14 35

Электронная почта: sales@st-electron.ru

Адрес: 198099, Санкт-Петербург,
Промышленная ул, дом № 19, литера Н,
помещение 100-Н Офис 331