

---

## Low ON Resistance Nch Load Switch IC

---

NO.EA-319-140526

### OUTLINE

The R5541K is a CMOS-based dual supply voltage load switch IC. The R5541K is an ideal switch for supplying the power from the secondary power source such as the output of a step-down DC/DC converter to the load circuit. A built-in Nch. transistor with typically 18 mΩ ON resistance allows the R5541K to provide a low dropout voltage and prevents the reverse current during shutdown mode. Internally, a single IC consists of an internal voltage step-up circuit, a soft-start circuit, a thermal shutdown circuit, a chip enable circuit and a UVLO circuit.

The gate voltage of Nch. driver transistor is supplied by a soft-start circuit. The soft-start circuit is supplied by the external power source ( $V_{BIAS}$ ). Soft-start time is adjustable by connecting an external capacitor.

The R5541K is offered in an ultra-small 6-pin DFN(PLP)1216-6G package which achieve the smallest possible footprint solution on boards where area is limited.

### FEATURES

- Supply Current ..... Typ. 25  $\mu$ A ( $I_{OUT} = 0$  mA)
- Standby Current..... Typ. 0.01  $\mu$ A
- $V_{IN}$  Input Voltage Range..... 0.6 V to 4.8 V
- $V_{BIAS}$  Input Voltage Range ..... 2.5 V to 5.5 V
- Switch ON Resistance..... Typ. 18 mΩ ( $V_{IN} = 1.0$  V,  $V_{BIAS} = 5.0$  V)
- Output Current..... Max. 3 A
- A single Nch MOSFET Circuit
- Soft-start Function
- Thermal Shutdown Circuit
- Auto-discharge Function (R5541K001D)
- Package..... DFN(PLP)1216-6G

### APPLICATIONS

- Secondary Power Source for hand-held communication equipments and laptop PCs

### BLOCK DIAGRAMS

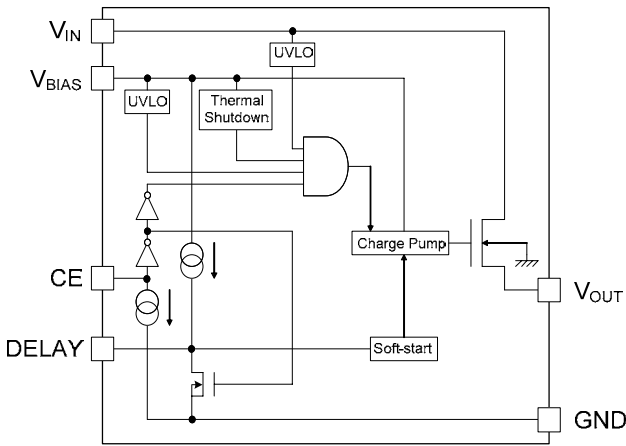

R5541K001B Block Diagram

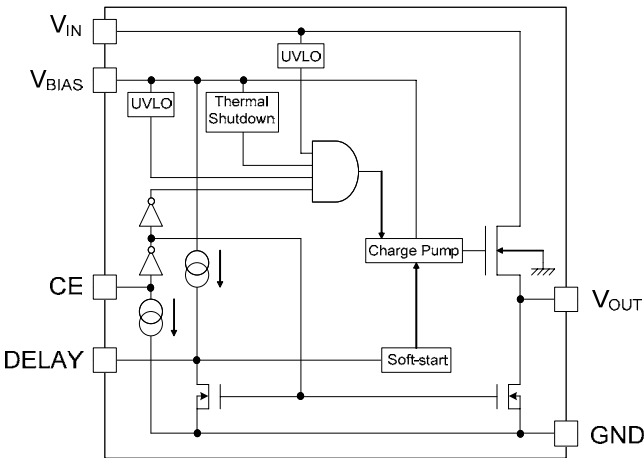

R5541K001D Block Diagram

### SELECTION GUIDE

The auto-discharge function\*1 is a user-selectable option.

#### Selection Guide

Product Name	Package	Quantity per Reel	Pb Free	Halogen Free
R5541K001*-E2	DFN(PLP)1216-6G	5,000 pcs	Yes	Yes

\*: Specify the CE Pin Polarity and auto-discharge option.

- B: Active-High, no auto-discharge function
- D: Active-High, auto-discharge function

\*1 Auto-discharge function quickly lowers the output voltage to 0 V, when the chip enable signal is switched from the active mode to the standby mode, by releasing the electrical charge accumulated in the external capacitor.

## PIN DESCRIPTION

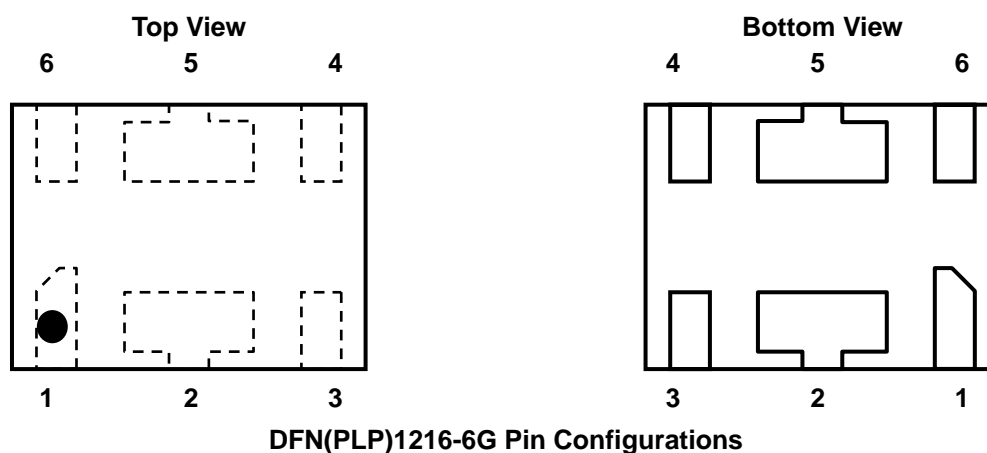

## DFN(PLP)1216-6G Pin Description

Pin No.	Symbol	Description
1	CE	Chip Enable Pin (Active-High)
2	V <sub>IN</sub>	Input Pin 2* <sup>1</sup>
3	V <sub>BIAS</sub>	Input Pin 1* <sup>1</sup>
4	GND	Ground Pin
5	V <sub>OUT</sub>	Output Pin
6	DELAY	DELAY Pin for Soft-start Setting

\*<sup>1</sup> V<sub>IN</sub> should be used as V<sub>IN</sub> ≤ V<sub>BIAS</sub>.

## ABSOLUTE MAXIMUM RATINGS

### Absolute Maximum Ratings

Symbol	Item	Rating	Unit
$V_{BIAS}$	$V_{BIAS}$ Pin Input Voltage	-0.3 to 6.0	V
$V_{IN}$	$V_{IN}$ Pin Input Voltage	-0.3 to 5.5	V
$V_{CE}$	CE Pin Input Voltage	-0.3 to 6.0	V
$V_{OUT}$	$V_{OUT}$ Pin Voltage	-0.3 to $V_{IN}$	V
$I_{OUT}$	Output Current	3.0	A
$P_D$	Power Dissipation (JEDEC STD.51-7 Test Land Pattern)*1	714	mW
$T_j$	Junction Temperature	-40 to 125	°C
$T_{stg}$	Storage Temperature Range	-55 to 125	°C

\*1 Refer to *PACKAGE INFORMATION* for detailed information.

### ABSOLUTE MAXIMUM RATINGS

Electronic and mechanical stress momentarily exceeded absolute maximum ratings may cause the permanent damages and may degrade the life time and safety for both device and system using the device in the field. The functional operation at or over these absolute maximum ratings is not assured.

### RECOMMENDED OPERATING CONDITIONS (ELECTRICAL CHARACTERISTICS)

All of electronic equipment should be designed that the mounted semiconductor devices operate within the recommended operating conditions. The semiconductor devices cannot operate normally over the recommended operating conditions, even if when they are used over such conditions by momentary electronic noise or surge. And the semiconductor devices may receive serious damage when they continue to operate over the recommended operating conditions.

## ELECTRICAL CHARACTERISTICS

$V_{BIAS} = 5.0\text{ V}$ ,  $V_{IN} = 1.0\text{ V}$ ,  $C_{BIAS} = 1\text{ }\mu\text{F}$ ,  $C_{IN} = \text{none}$ ,  $C_{OUT} = 0.1\text{ }\mu\text{F}$ , unless otherwise noted.

The specifications surrounded by   are guaranteed by Design Engineering at  $-40^{\circ}\text{C} \leq T_a \leq 85^{\circ}\text{C}$ .

### R5541K Electrical Characteristics

( $T_a = 25^{\circ}\text{C}$ )

Symbol	Item	Conditions	Min.	Typ.	Max.	Unit	
$V_{BIAS}$	$V_{BIAS}$ Pin Input Voltage		<span style="border: 1px solid black; padding: 0 2px;">2.5</span>		<span style="border: 1px solid black; padding: 0 2px;">5.5</span>	V	
$V_{IN}$	$V_{IN}$ Pin Input Voltage		<span style="border: 1px solid black; padding: 0 2px;">0.6</span>		<span style="border: 1px solid black; padding: 0 2px;">4.8</span>	V	
$R_{ON}$	Switch ON Resistance	$I_{OUT} = 500\text{ mA}$		18	<span style="border: 1px solid black; padding: 0 2px;">28</span>	m $\Omega$	
$I_{SS}$	Supply Current	$I_{OUT} = 0\text{ mA}$ , $V_{BIAS}$ Pin		25	<span style="border: 1px solid black; padding: 0 2px;">47</span>	$\mu\text{A}$	
$I_{standby}$	Standby Current	$V_{CE} = 0\text{ V}$ , $V_{IN} = 4.8\text{ V}$ , $V_{BIAS} = 5.5\text{ V}$	$V_{BIAS}$ Pin		0.01	0.15	$\mu\text{A}$
		$V_{IN}$ Pin		0.01	1	$\mu\text{A}$	
$UVLO$	Undervoltage Lockout Voltage	$V_{BIAS}$ Pin <sup>*1</sup>	<span style="border: 1px solid black; padding: 0 2px;">2.0</span>		<span style="border: 1px solid black; padding: 0 2px;">2.49</span>	V	
		$V_{IN}$ Pin <sup>*2</sup>	<span style="border: 1px solid black; padding: 0 2px;">0.3</span>		<span style="border: 1px solid black; padding: 0 2px;">0.59</span>	V	
$T_{TSD}$	Thermal Shutdown Temperature	Junction Temperature		145		$^{\circ}\text{C}$	
$T_{TSR}$	Thermal Shutdown Release Temperature	Junction Temperature		125		$^{\circ}\text{C}$	
$I_{CEPD}$	CE Pull-down Current			0.4	<span style="border: 1px solid black; padding: 0 2px;">0.8</span>	$\mu\text{A}$	
$V_{CEH}$	CE Input Voltage "H"		<span style="border: 1px solid black; padding: 0 2px;">1.0</span>			V	
$V_{CEL}$	CE Input Voltage "L"				<span style="border: 1px solid black; padding: 0 2px;">0.4</span>	V	
$I_{DELAY}$	DELAY Pin Current	<sup>*3</sup>	<span style="border: 1px solid black; padding: 0 2px;">1.25</span>	1.5	<span style="border: 1px solid black; padding: 0 2px;">1.8</span>	$\mu\text{A}$	
$R_{LOW}$	Low Output Nch Tr. ON Resistance (R5541K001D)	$V_{CE} = 0\text{ V}$		80		$\Omega$	

All test items listed under *ELECTRICAL CHARACTERISTICS* are done under the pulse load condition ( $T_j \approx T_a = 25^{\circ}\text{C}$ ).

<sup>\*1</sup> The UVLO detector threshold and the UVLO release voltage are between the min and the max of UVLO with Typ. 90 mV hysteresis.

<sup>\*2</sup> The UVLO detector threshold and the UVLO release voltage are between the min and the max of UVLO with Typ. 70 mV hysteresis.

<sup>\*3</sup> Soft-start time can be adjusted by using  $I_{DELAY}$  and a capacitor ( $C_D$ ). Refer to *Soft-start Function* in *TECHNICAL NOTES* for detailed information.

## TYPICAL APPLICATION

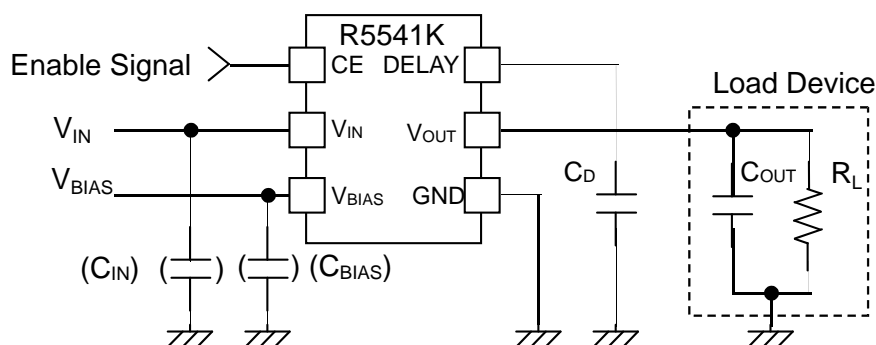

R5541K Typical Application

## TECHNICAL NOTES

The performance of a power source circuit using this device is highly dependent on a peripheral circuit. A peripheral component or the device mounted on PCB should not exceed a rated voltage, a rated current or a rated power. When designing a peripheral circuit, please be fully aware of the following points.

- An input capacitor ( $C_{IN}$ ) and a bypass capacitor ( $C_{BIAS}$ ) are NOT necessarily required between the  $V_{IN}$  pin and GND. If there is a possibility that the parasitic element (inductance) of  $V_{IN}$  may generate spike noise, connect an appropriate capacitor (about  $0.1 \mu\text{F}$ ) between the  $V_{IN}$  pin and GND.
- $V_{IN}$  and  $V_{BIAS}$  should always be used as  $V_{IN} \leq V_{BIAS}$ .
- Connect the DELAY pin to a capacitor ( $C_D$ ) or leave the DELAY pin floating.

## SOFT-START FUNCTION

Soft-start function maintains the smooth control of the output voltage to prevent an inrush current during start-up by adjusting the soft-start time ( $t_{start}$ ) ( $V_{OUT} = 10\%$  to  $90\%$ ).  $t_{start}$  can be adjusted by connecting a capacitor ( $C_D$ ) between the DELAY pin and GND. The calculation of  $C_D$  is as follows.

$$C_D [\text{nF}] = 7.5 \times t_{start} [\text{ms}] \times I_{DELAY} [\mu\text{A}] / V_{IN} [\text{V}]$$

If  $C_D$  is not connected to the DELAY pin, leave the DELAY pin floating. If the DELAY pin is left floating, the calculation of the start-up time ( $t_r$ ) ( $V_{OUT} = 10\%$  to  $90\%$ ) is as follows.

$$t_r [\text{ms}] = 0.04 \times V_{IN} [\text{V}] \text{ (Typ.)}$$

$V_{BIAS}$ ,  $V_{IN}$  and CE can be sequenced in any order; the device can start up with soft-start function.

**PACKAGE INFORMATION**

**POWER DISSIPATION (DFN(PLP)1216-6G)**

Power Dissipation ( $P_D$ ) of the package is dependent on PCB material, layout, and environmental conditions. The following conditions are used in this measurement.

Measurement Conditions

JEDEC STD.51-7 Test Land Pattern	
Environment	Mounting on Board (Wind Velocity = 0m/s)
Board Material	Glass Cloth Epoxy Plastic (4 Layer)
Board Dimensions	76.2 mm x 114.3 mm x 1.6 mm
Copper Ratio	Top side, Back side: 60 mm x 60mm, Approx.10% 2nd, 3rd layers: 74.2 mm x 74.2 mm, Approx. 100%
Through-holes	$\phi$ 0.85 mm x 44 pcs

Measurement Result

( $T_a = 25^\circ\text{C}$ ,  $T_{j\text{max}} = 125^\circ\text{C}$ )

JEDEC STD.51-7 Test Land Pattern	
Power Dissipation	714 mW
Thermal Resistance	$\theta_{ja} = (125 - 25^\circ\text{C}) / 0.714 \text{ W} = 140^\circ\text{C/W}$
	$\theta_{jc} = 21^\circ\text{C/W}$

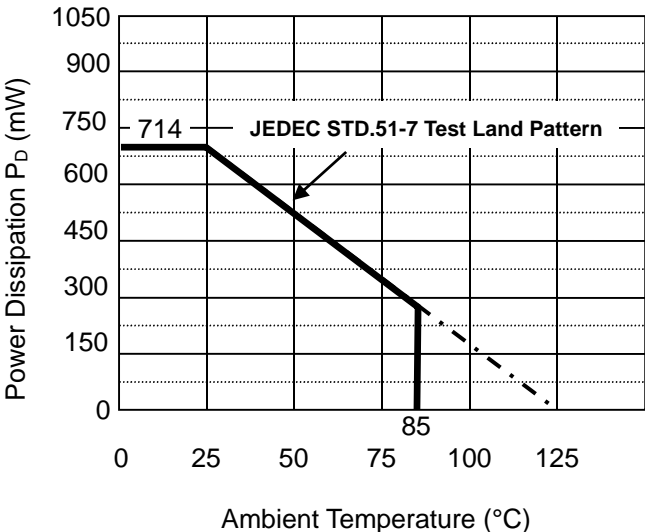

Ambient Temperature vs. Power Dissipation

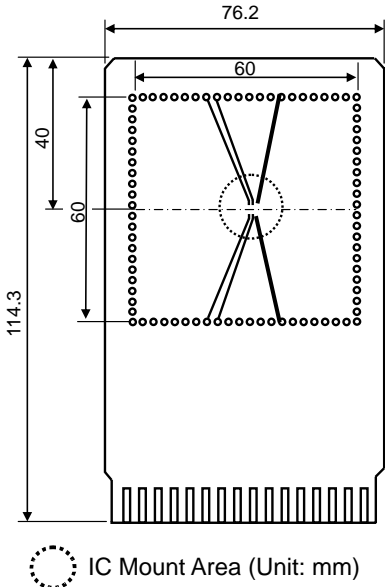

Measurement Board Pattern



PACKAGE DIMENSIONS (DFN(PLP)1216-6G)

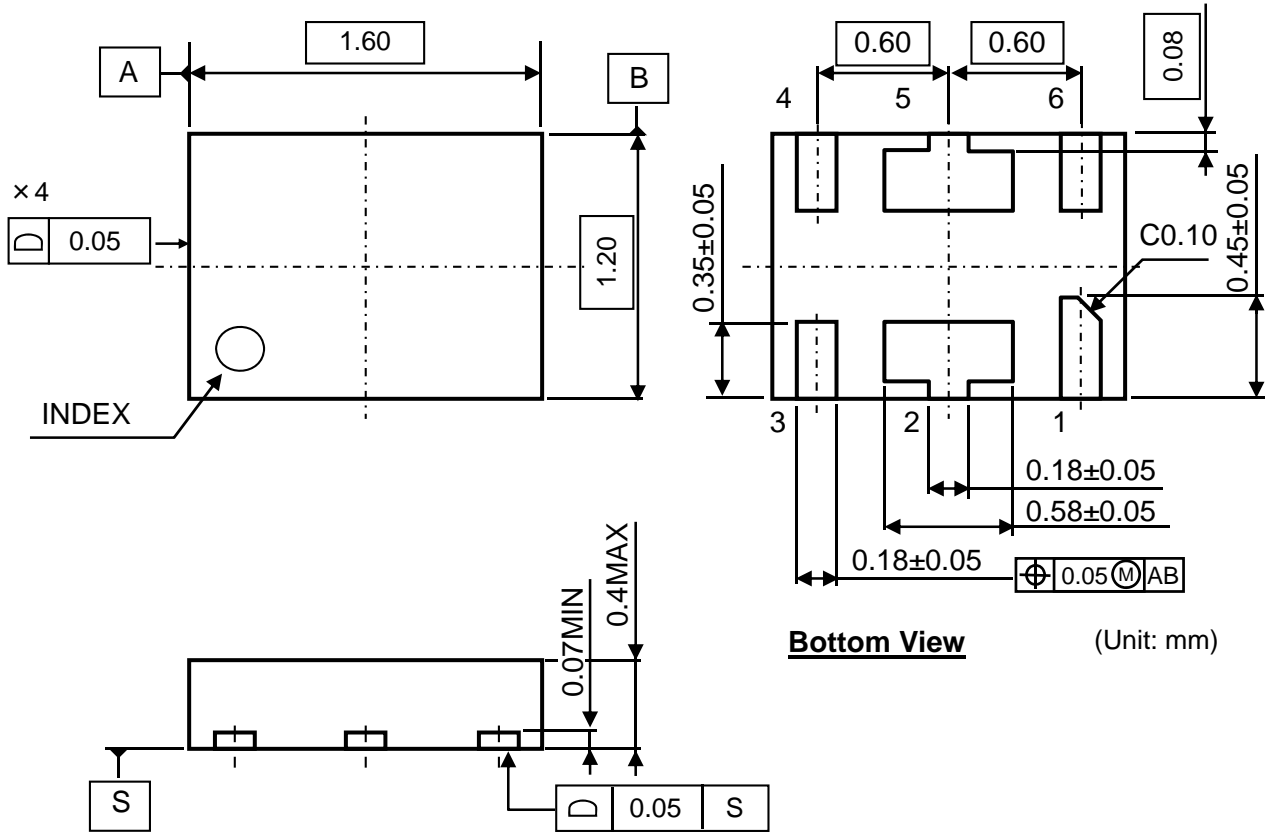

DFN(PLP)1216-6G Package Dimensions

MARK SPECIFICATION (DFN(PLP)1216-6G)

①②③④: Product Code ...**Refer to MARK SPECIFICATION TABLE DFN(PLP)1216-6G.**

⑤⑥: Lot Number ...Alphanumeric Serial Number

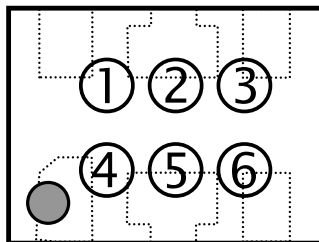

DFN(PLP)1216-6G Mark Specification

MARK SPECIFICATION TABLE (DFN(PLP)1216-6G)

Mark Specification Table

Product Name	①②③④
R5541K001B	D Z 0 1
R5541K001D	D Z 0 3

# TYPICAL CHARACTERISTICS

Note: Typical Characteristics are intended to be used as reference data; they are not guaranteed.

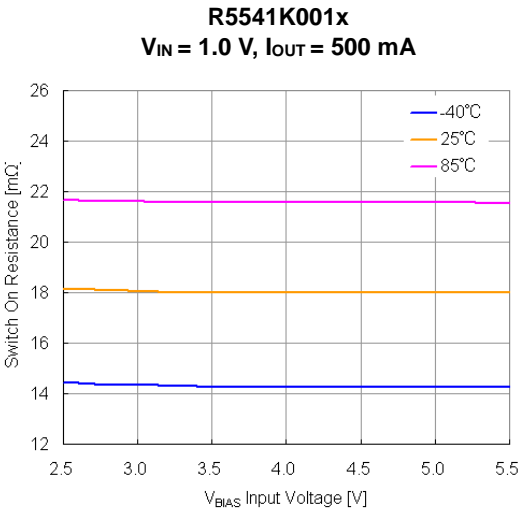

Switch On Resistance vs. V<sub>BIAS</sub> Input Voltage

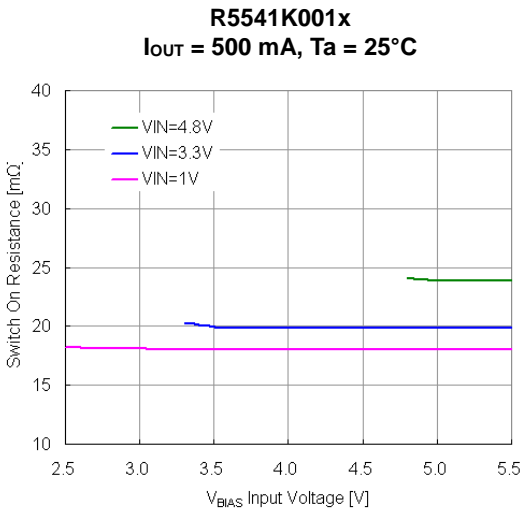

Switch On Resistance vs. V<sub>BIAS</sub> Input Voltage

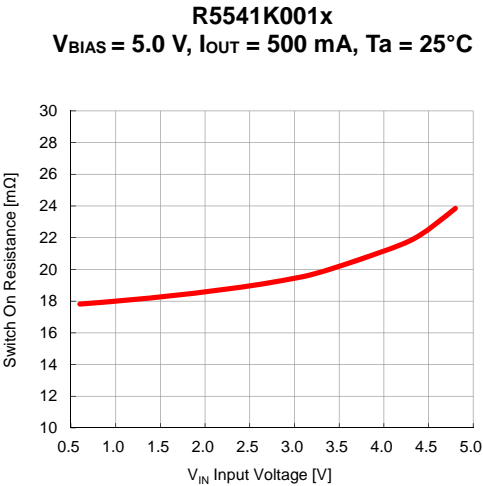

Switch On Resistance vs. V<sub>IN</sub> Input Voltage

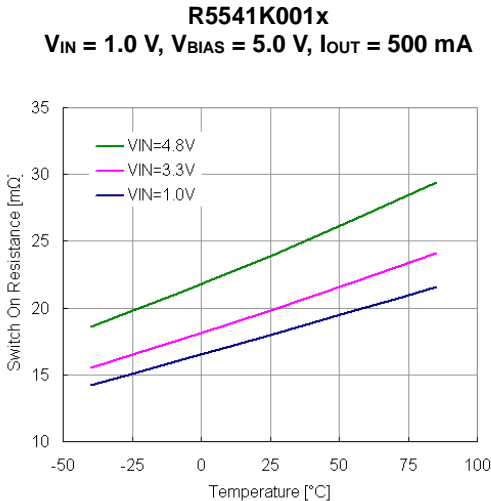

Switch On Resistance vs. Temperature

**R5541K001x**  
**V<sub>IN</sub> = 4.8 V, V<sub>BIAS</sub> = 5.5 V**

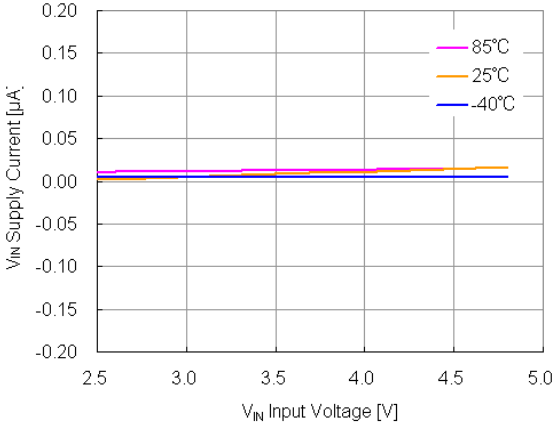

**V<sub>IN</sub> Supply Current vs. V<sub>IN</sub> Input Voltage**

**R5541K001x**  
**V<sub>IN</sub> = 1.0 V**

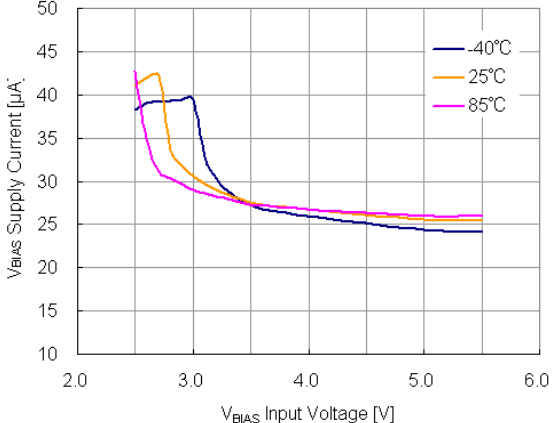

**V<sub>BIAS</sub> Supply Current vs. V<sub>BIAS</sub> Input Voltage**

**R5541K001x**  
**V<sub>BIAS</sub> = 5.5 V**

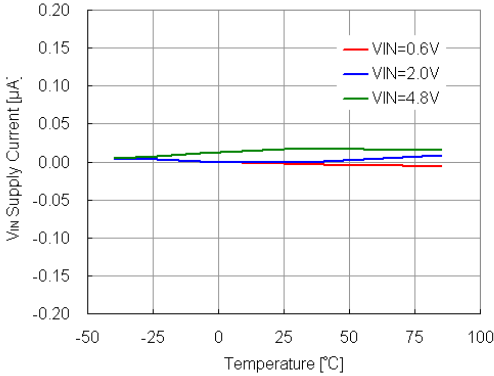

**V<sub>IN</sub> Supply Current vs. Temperature**

**R5541K001x**  
**V<sub>IN</sub> = 0.6 V**

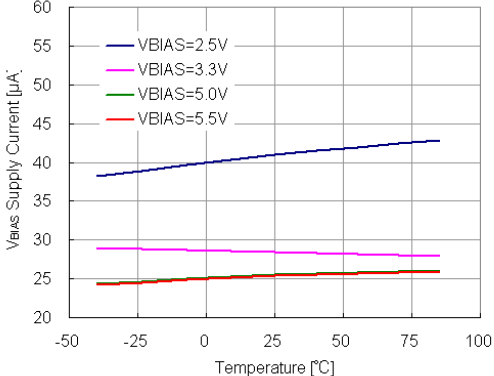

**V<sub>BIAS</sub> Supply Current vs. Temperature**

**R5541K001x**  
**V<sub>BIAS</sub> = 5.5 V**

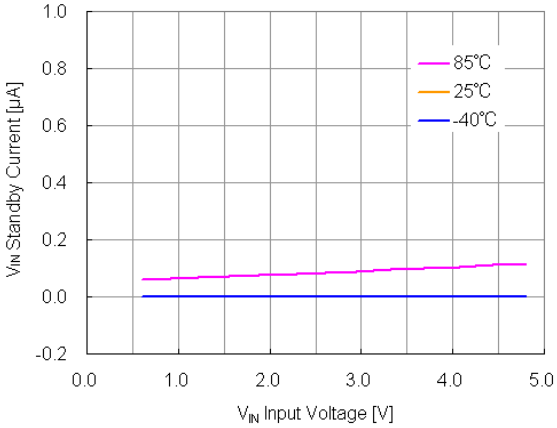

**V<sub>IN</sub> Standby Current vs. V<sub>IN</sub> Input Voltage**

**R5541K001x**  
**V<sub>IN</sub> = 0.6 V**

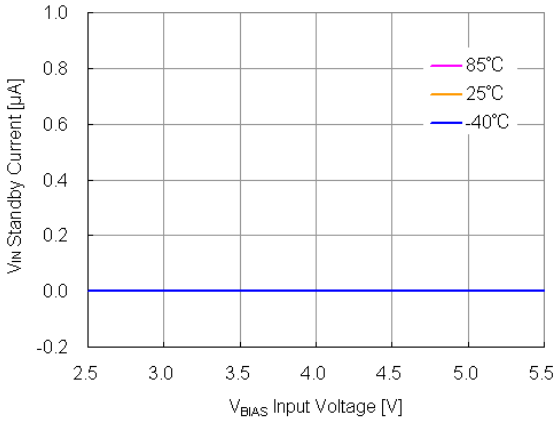

**V<sub>IN</sub> Standby Current vs. V<sub>BIAS</sub> Input Voltage**

**R5541K001x**  
**V<sub>BIAS</sub> = 5.5 V**

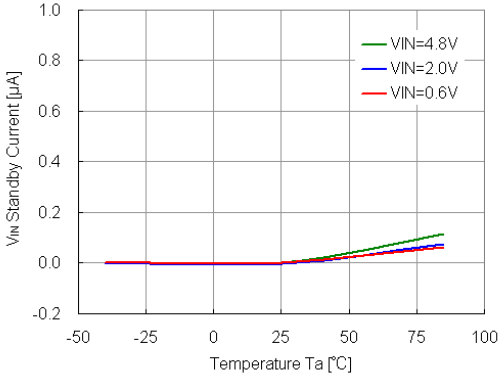

**V<sub>IN</sub> Standby Current vs. Temperature**

**R5541K001x**  
**V<sub>IN</sub> = 0.6 V**

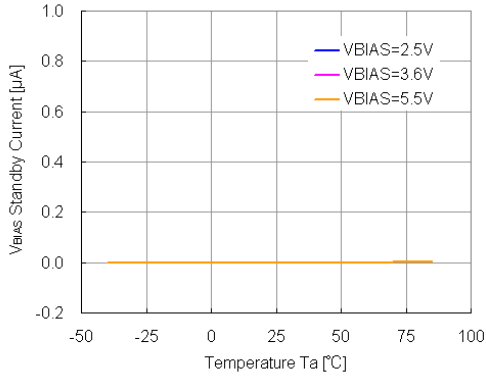

**V<sub>BIAS</sub> Standby Current vs. Temperature**

**R5541K001x**  
 $V_{IN} = 3.6\text{ V}$ ,  $V_{BIAS} = 5.5\text{ V}$ ,  $R_{LOAD} = 10\ \Omega$ ,  $C_{OUT} = 0.1\ \mu\text{F}$

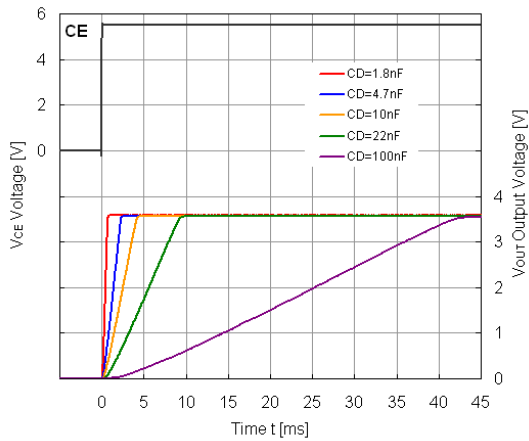

**V<sub>OUT</sub> Output Voltage On Time vs. DELAY Capacitance**

**R5541K001x**  
 $V_{IN} = 3.6\text{ V}$ ,  $V_{BIAS} = 5.5\text{ V}$ ,  $R_{LOAD} = 10\ \Omega$ ,  $C_{OUT} = 0.1\ \mu\text{F}$

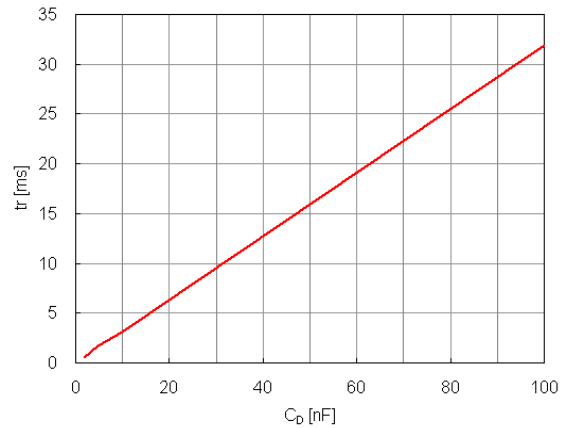

**tr vs. DELAY Capacitance**

**R5541K001x**  
 $V_{BIAS} = 5.0\text{ V}$ ,  $C_D = 10\text{ nF}$ ,  $R_{LOAD} = 10\ \Omega$ ,  $C_{OUT} = 0.1\ \mu\text{F}$

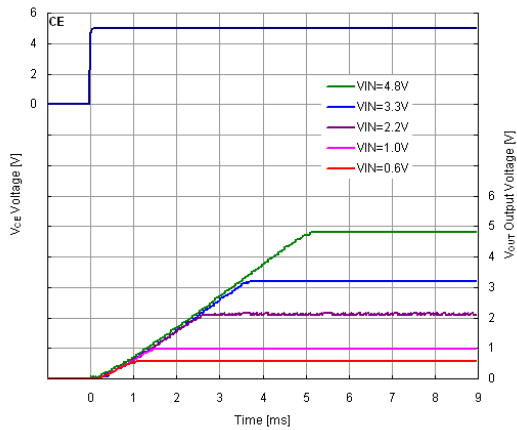

**V<sub>OUT</sub> Output Voltage On Time vs. V<sub>IN</sub> Input Voltage**

**R5541K001D**  
 $V_{BIAS} = 5.0\text{ V}$ ,  $C_D = 10\text{ nF}$ ,  $C_{OUT} = 0.1\ \mu\text{F}$

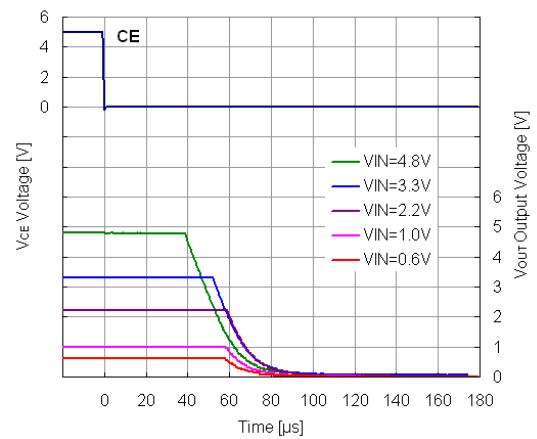

**V<sub>OUT</sub> Output Voltage Off Time vs. V<sub>IN</sub> Input Voltage**

**R5541K001x**  
 $V_{IN} = 4.8\text{ V}$ ,  $V_{BIAS} = 5.0\text{ V}$ ,  $C_D = 10\text{ nF}$ ,  $C_{OUT} = 0.1\ \mu\text{F}$

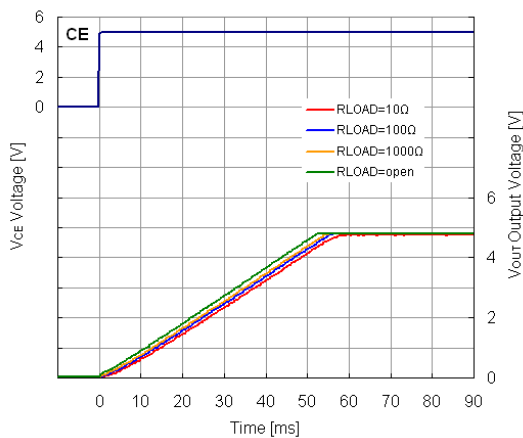

**V<sub>OUT</sub> Output Voltage On Time vs. Load Resistance**

**R5541K001D**  
 $V_{IN} = 4.8\text{ V}$ ,  $V_{BIAS} = 5.0\text{ V}$ ,  $C_D = 10\text{ nF}$ ,  $C_{OUT} = 0.1\ \mu\text{F}$

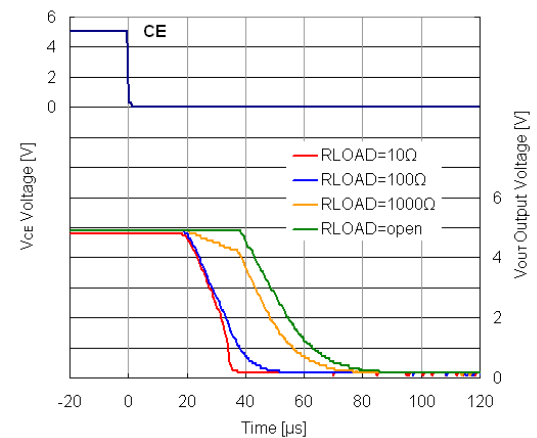

**V<sub>OUT</sub> Output Voltage Off Time vs. Load Resistance**

**R5541K001x**  
 $V_{IN} = 1.0\text{ V}$ ,  $V_{BIAS} = 5.5\text{ V}$ ,  $C_D = 10\text{ nF}$ ,  $C_{OUT} = 0.1\text{ }\mu\text{F}$

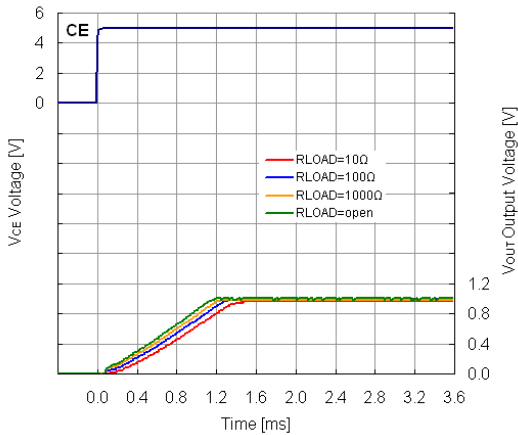

**V<sub>OUT</sub> Output Voltage On Time vs. Load Resistance**

**R5541K001D**  
 $V_{IN} = 1.0\text{ V}$ ,  $V_{BIAS} = 5.5\text{ V}$ ,  $C_D = 10\text{ nF}$ ,  $C_{OUT} = 0.1\text{ }\mu\text{F}$

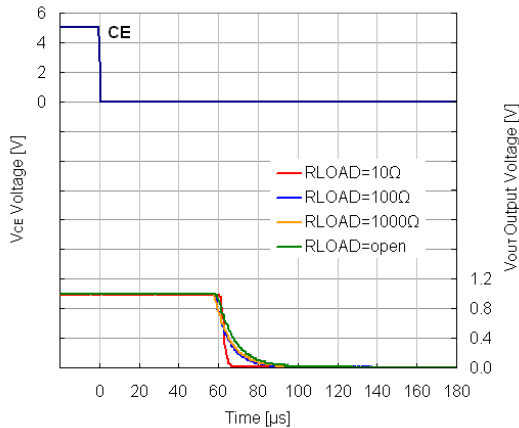

**V<sub>OUT</sub> Output Voltage Off Time vs. Load Resistance**

**R5541K001x**  
 $V_{IN} = 1.0\text{ V}$ ,  $C_D = 10\text{ nF}$ ,  $R_{LOAD} = 10\text{ }\Omega$ ,  $C_{OUT} = 0.1\text{ }\mu\text{F}$

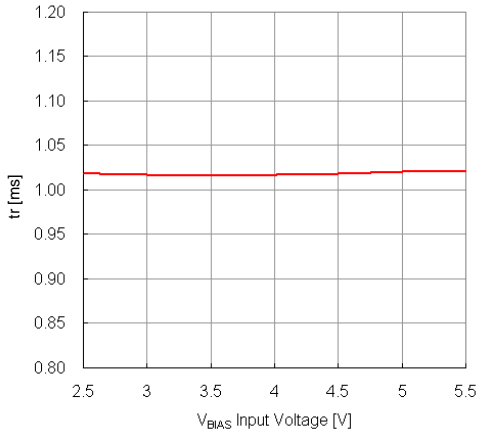

**tr vs. V<sub>BIAS</sub> Input Voltage**

**R5541K001x**  
 $V_{IN} = 1.0\text{ V}$ ,  $C_D = 10\text{ nF}$ ,  $R_{LOAD} = 10\text{ }\Omega$ ,  $C_{OUT} = 0.1\text{ }\mu\text{F}$

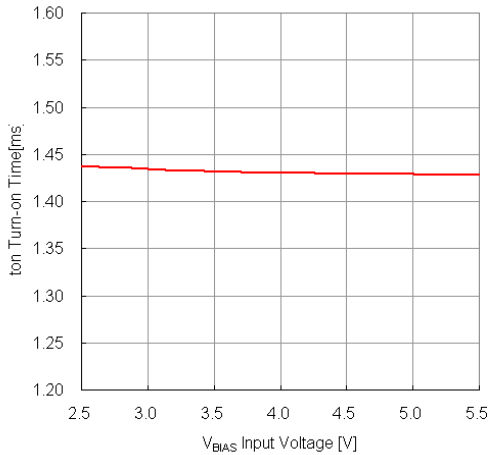

**ton Turn-on Time vs. V<sub>BIAS</sub> Input Voltage**

**R5541K001x**  
 $V_{IN} = 1.0\text{ V}$ ,  $R_{LOAD} = 10\text{ }\Omega$ ,  $C_{OUT} = 0.1\text{ }\mu\text{F}$

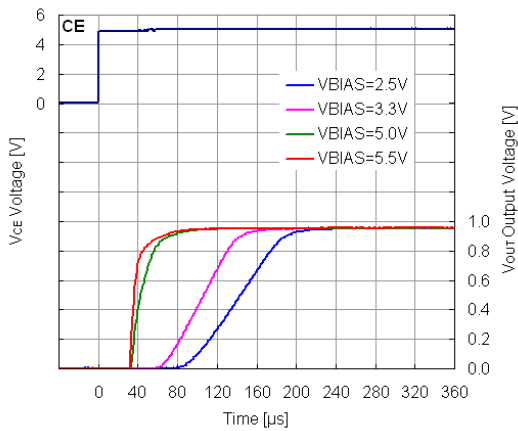

**V<sub>OUT</sub> Output Voltage On Time vs. V<sub>BIAS</sub> Input Voltage**



1. The products and the product specifications described in this document are subject to change or discontinuation of production without notice for reasons such as improvement. Therefore, before deciding to use the products, please refer to Ricoh sales representatives for the latest information thereon.
2. The materials in this document may not be copied or otherwise reproduced in whole or in part without prior written consent of Ricoh.
3. Please be sure to take any necessary formalities under relevant laws or regulations before exporting or otherwise taking out of your country the products or the technical information described herein.
4. The technical information described in this document shows typical characteristics of and example application circuits for the products. The release of such information is not to be construed as a warranty of or a grant of license under Ricoh's or any third party's intellectual property rights or any other rights.
5. The products listed in this document are intended and designed for use as general electronic components in standard applications (office equipment, telecommunication equipment, measuring instruments, consumer electronic products, amusement equipment etc.). Those customers intending to use a product in an application requiring extreme quality and reliability, for example, in a highly specific application where the failure or misoperation of the product could result in human injury or death (aircraft, spacevehicle, nuclear reactor control system, traffic control system, automotive and transportation equipment, combustion equipment, safety devices, life support system etc.) should first contact us.
6. We are making our continuous effort to improve the quality and reliability of our products, but semiconductor products are likely to fail with certain probability. In order to prevent any injury to persons or damages to property resulting from such failure, customers should be careful enough to incorporate safety measures in their design, such as redundancy feature, fire containment feature and fail-safe feature. We do not assume any liability or responsibility for any loss or damage arising from misuse or inappropriate use of the products.
7. Anti-radiation design is not implemented in the products described in this document.
8. Please contact Ricoh sales representatives should you have any questions or comments concerning the products or the technical information.



**Ricoh is committed to reducing the environmental loading materials in electrical devices with a view to contributing to the protection of human health and the environment.**

Ricoh has been providing RoHS compliant products since April 1, 2006 and Halogen-free products since April 1, 2012.

**RICOH** RICOH ELECTRONIC DEVICES CO., LTD.

<http://www.e-devices.ricoh.co.jp/en/>

#### Sales & Support Offices

##### **RICOH ELECTRONIC DEVICES CO., LTD.**

**Higashi-Shinagawa Office (International Sales)**  
3-32-3, Higashi-Shinagawa, Shinagawa-ku, Tokyo 140-8655, Japan  
Phone: +81-3-5479-2857 Fax: +81-3-5479-0502

##### **RICOH EUROPE (NETHERLANDS) B.V.**

**Semiconductor Support Centre**  
Prof. W.H. Keesomlaan 1, 1183 DJ Amstelveen, The Netherlands  
Phone: +31-20-5474-309

##### **RICOH ELECTRONIC DEVICES KOREA CO., LTD.**

3F, Haesung Bldg. 504, Teheran-ro, Gangnam-gu, Seoul, 135-725, Korea  
Phone: +82-2-2135-5700 Fax: +82-2-2051-5713

##### **RICOH ELECTRONIC DEVICES SHANGHAI CO., LTD.**

Room 403, No.2 Building, No.690 Bilbo Road, Pu Dong New District, Shanghai 201203,  
People's Republic of China  
Phone: +86-21-5027-3200 Fax: +86-21-5027-3299

##### **RICOH ELECTRONIC DEVICES CO., LTD.**

**Taipei office**  
Room 109, 10F-1, No.51, Hengyang Rd., Taipei City, Taiwan (R.O.C.)  
Phone: +886-2-2313-1621/1622 Fax: +886-2-2313-1623

# Mouser Electronics

Authorized Distributor

Click to View Pricing, Inventory, Delivery & Lifecycle Information:

[Ricoh Electronics:](#)

[R5541K001B-E2](#)





## Стандарт Электрон Связь

Мы молодая и активно развивающаяся компания в области поставок электронных компонентов. Мы поставляем электронные компоненты отечественного и импортного производства напрямую от производителей и с крупнейших складов мира.

Благодаря сотрудничеству с мировыми поставщиками мы осуществляем комплексные и плановые поставки широчайшего спектра электронных компонентов.

Собственная эффективная логистика и склад в обеспечивает надежную поставку продукции в точно указанные сроки по всей России.

Мы осуществляем техническую поддержку нашим клиентам и предпродажную проверку качества продукции. На все поставляемые продукты мы предоставляем гарантию .

Осуществляем поставки продукции под контролем ВП МО РФ на предприятия военно-промышленного комплекса России , а также работаем в рамках 275 ФЗ с открытием отдельных счетов в уполномоченном банке. Система менеджмента качества компании соответствует требованиям ГОСТ ISO 9001.

Минимальные сроки поставки, гибкие цены, неограниченный ассортимент и индивидуальный подход к клиентам являются основой для выстраивания долгосрочного и эффективного сотрудничества с предприятиями радиоэлектронной промышленности, предприятиями ВПК и научно-исследовательскими институтами России.

С нами вы становитесь еще успешнее!

### Наши контакты:

**Телефон:** +7 812 627 14 35

**Электронная почта:** [sales@st-electron.ru](mailto:sales@st-electron.ru)

**Адрес:** 198099, Санкт-Петербург,  
Промышленная ул, дом № 19, литера Н,  
помещение 100-Н Офис 331