

## Applications

- S-Band Radar

## Product Features

- Frequency Range: 2.5 to 4 GHz
- 6-Bit Digital Phase Shifter
- Bi-Directional
- 360° Coverage, LSB = 5.625°
- RMS Phase Error: < 2° (2.7 – 3.7 GHz)  
< 5° (other frequencies)
- RMS Amplitude Error: < 0.4 dB
- Insertion Loss: 5 dB
- Return Loss: 15 dB
- Input P1dB: 29 dBm
- Input IP3: 45 dBm
- Control Voltage: 0 / +3V to +5 V
- QFN Package Dimensions: 5.0 x 5.0 x 0.85 mm

## General Description

The Qorvo TGP2108-SM is a packaged 6-bit digital phase shifter fabricated on Qorvo's high performance 0.15 μm GaAs pHEMT process. It operates over 2.5-4 GHz while providing 360° of phase coverage with a LSB of 5.625°. The TGP2108-SM offers an exceptional RMS phase error of <2° and amplitude error of <0.4 dB over most of the operational band. With other equally impressive small signal and linearity characteristics, the TGP2108-SM delivers superior performance for your S-band phased array applications.

Housed in a small 5 x 5 mm plastic overmold QFN package, DC blocked on both ports with bi-directional operation and the use of positive only control logic, the TGP2108-SM supports ease of use and simply system integration. Low DC power consumption also provides the system designer more flexibility in the overall power management of the system.

The device is lead-free and RoHS compliant.

Evaluation Boards are available upon request.

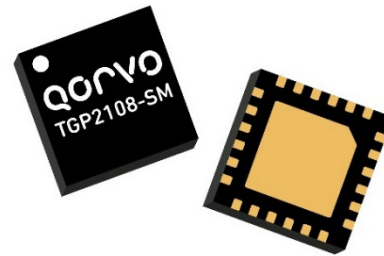

QFN 5x5 mm 24L

## Functional Block Diagram

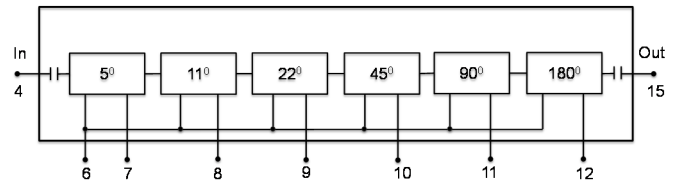

## Pin Configuration

Pin No.	Symbol
1-3, 5, 13-14, 16-24	N/C
4	RF In
6	REF
7	5° Bit
8	11° Bit
9	22° Bit
10	45° Bit
11	90° Bit
12	180° Bit
15	RF Out

## Ordering Information

Part	ECCN	Description
TGP2108-SM	EAR99	2.5-4GHz 6-Bit Digital Phase Shifter

### Absolute Maximum Ratings

Parameter	Value
Control and Reference Voltage	6 V
Control Current	1 mA
Power Dissipation	1.5 W
Input Power, CW, 50 Ω, 85 °C	33 dBm
Channel Temperature	200 °C
Mounting Temperature (30 Seconds)	260 °C
Storage Temperature	-55 to 150 °C

Operation of this device outside the parameter ranges given above may cause permanent damage. These are stress ratings only, and functional operation of the device at these conditions is not implied.

### Recommended Operating Conditions

Parameter	Value
Control Voltage (REF, 5 <sup>0</sup> , 11 <sup>0</sup> , 22 <sup>0</sup> , 45 <sup>0</sup> , 90 <sup>0</sup> , 180 <sup>0</sup> )	0/+5 V
Current (I <sub>REF</sub> , I <sub>CTRL</sub> )	< 0.3 mA
Temperature Range	-40 to +85 °C

Electrical specifications are measured at specified test conditions. Specifications are not guaranteed over all operating conditions.

### Electrical Specifications

Test conditions unless otherwise noted: 25 °C. Control Voltage (REF, 5<sup>0</sup>, 11<sup>0</sup>, 22<sup>0</sup>, 45<sup>0</sup>, 90<sup>0</sup>, 180<sup>0</sup>) = 0/+5 V; See Bias Truth Table.

Parameter	Min	Typical	Max	Units
Operational Frequency Range	2.5		4	GHz
Insertion Loss		5		dB
Input Return Loss		15		dB
Output Return Loss		15		dB
RMS Phase Error		2.7 – 3.7 GHz: < 2 Other Freq.: < 5		deg
RMS Amplitude Error		< 0.4		dB
Input P1dB		29		dBm
Input IP3 (Tone Spacing = 10 MHz, Pin/Tone = 8 dBm)		45		dBm
Insertion Loss Temperature Coefficient		0.002		dB/°C

### Bias Truth Table

Logic "0" = 0 V, Logic "1" = +3V or +5 V

Phase Shifter	5 <sup>0</sup>	11 <sup>0</sup>	22 <sup>0</sup>	45 <sup>0</sup>	90 <sup>0</sup>	180 <sup>0</sup>	REF
0° (Reference)	0	0	0	0	0	0	1
5°	1	0	0	0	0	0	0
11°	0	1	0	0	0	0	0
22°	0	0	1	0	0	0	0
45°	0	0	0	1	0	0	1
90°	0	0	0	0	1	0	1
180°	0	0	0	0	0	1	1
355°	1	1	1	1	1	1	1

**Thermal and Reliability Information**

Parameter	Test Conditions	Value	Units
Channel Temperature ( $T_{CH}$ )	$T_{BASEPLATE} = 85^{\circ}\text{C}$	85	$^{\circ}\text{C}$
Median Lifetime ( $T_M$ )		5.2E+9	Hrs

Notes:

- Under normal (lifetime) operating conditions, self-heating is not a significant contributor to channel temperature.

**Median Lifetime**

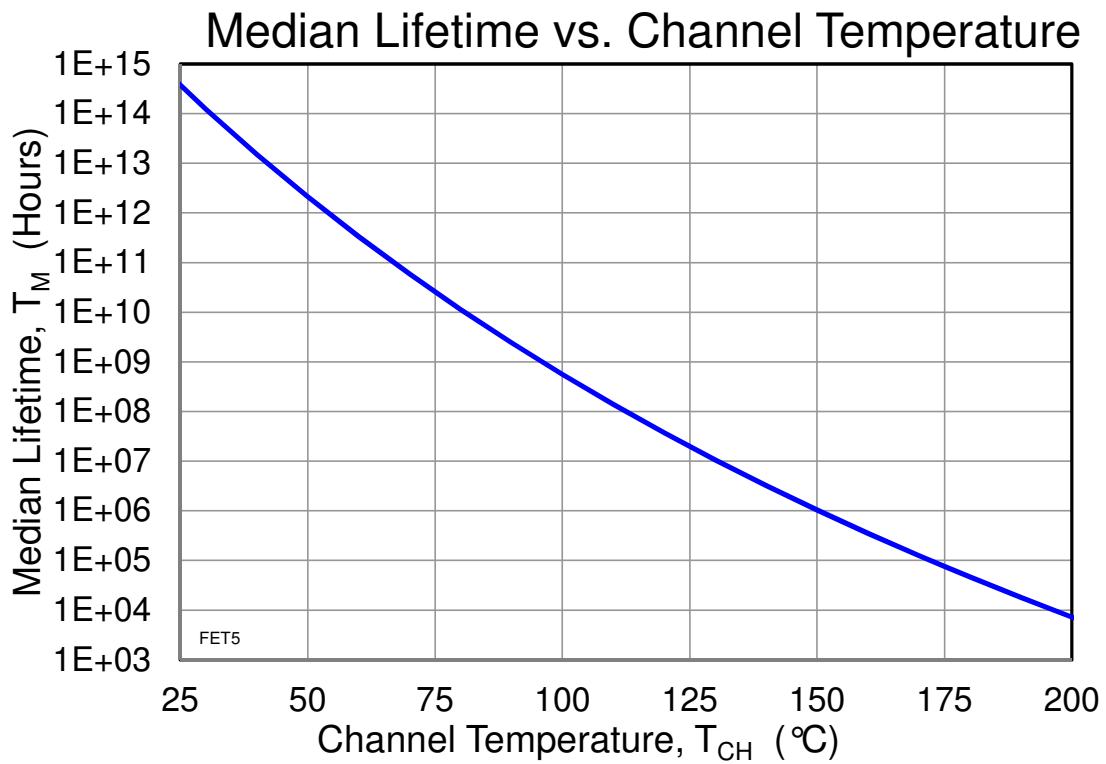

**Typical Performance – Small Signal**

Test conditions unless otherwise noted: 5V and 3V, 25 °C

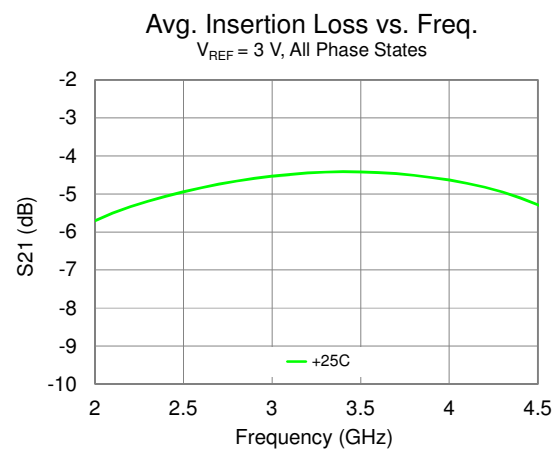
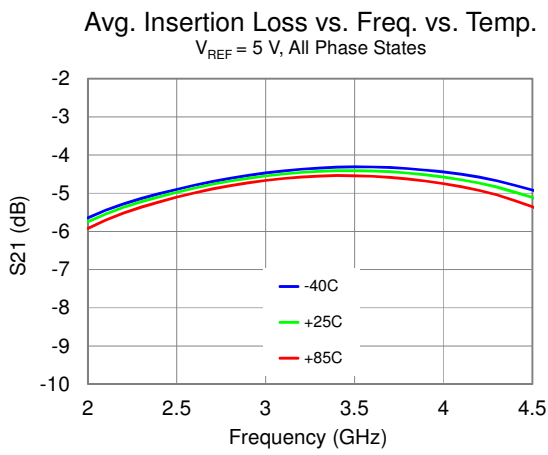
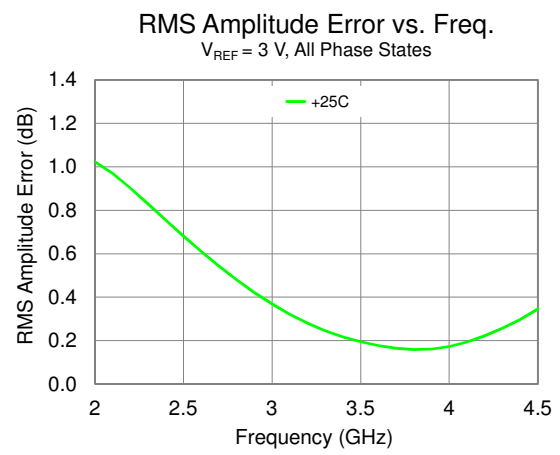
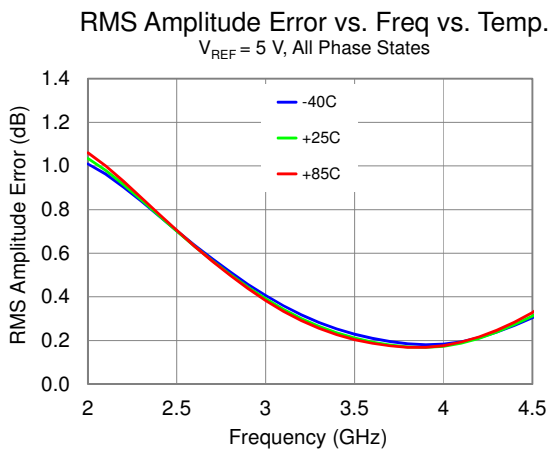
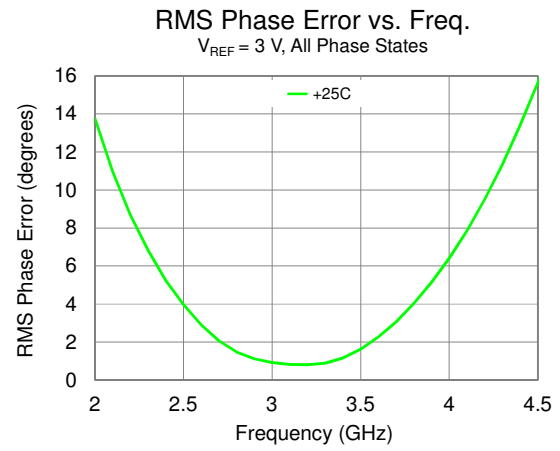
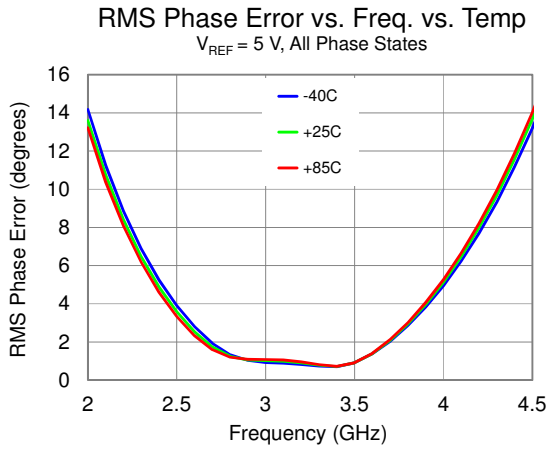

**Typical Performance – Small Signal (Cont.)**

Test conditions unless otherwise noted: 5V and 3V, 25 °C

Avg. IRL vs. Freq. vs. Temp.  
 $V_{REF} = 5\text{ V}$ , All Phase States

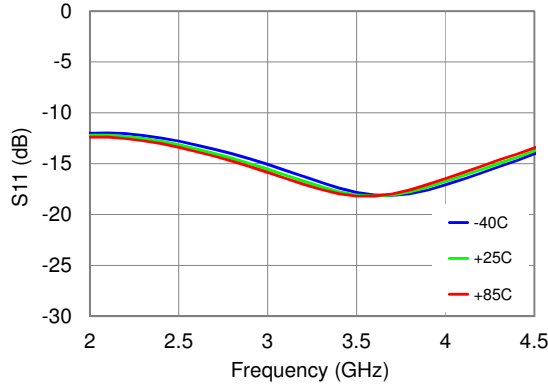

Avg. IRL vs. Freq.  
 $V_{REF} = 3\text{ V}$ , All Phase States

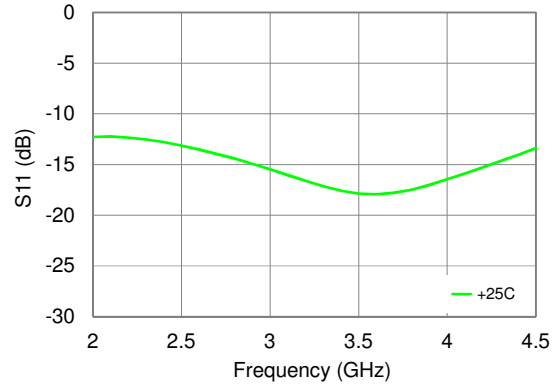

IRL vs. Freq.  
 $V_{REF} = 5\text{ V}$ , All Phase States, 25 °C

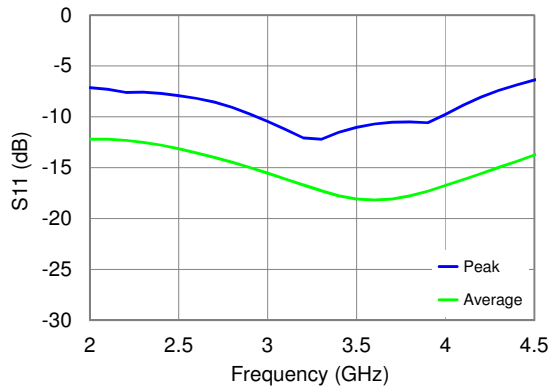

IRL vs. Freq.  
 $V_{REF} = 3\text{ V}$ , All Phase States, 25 °C

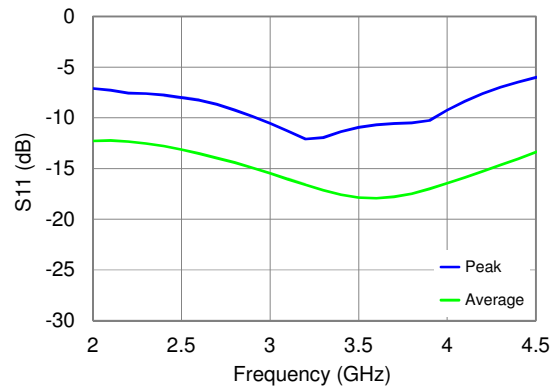

Avg. ORL vs. Freq. vs. Temp  
 $V_{REF} = 5\text{ V}$ , All Phase States

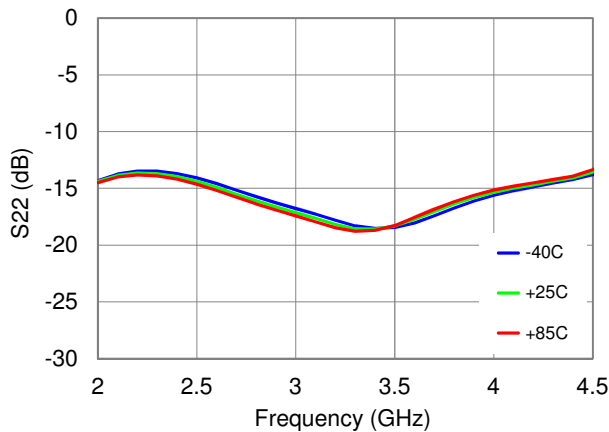

Avg. ORL vs. Freq.  
 $V_{REF} = 3\text{ V}$ , All Phase States

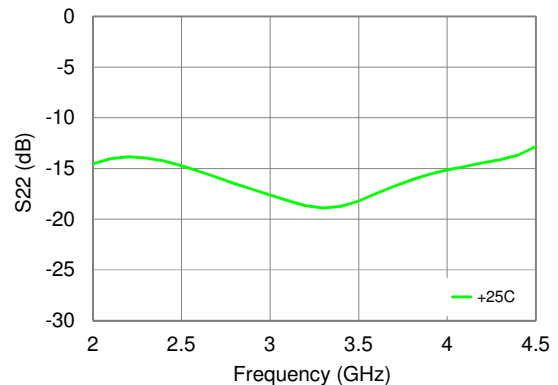

**Typical Performance – Small Signal (Cont.)**

Test conditions unless otherwise noted: 5V and 3V, 25 °C

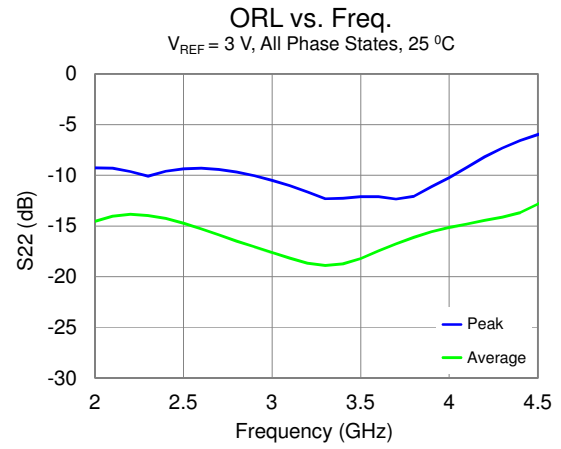
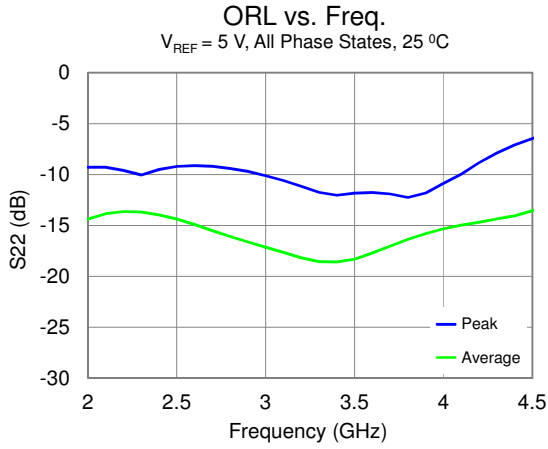

**Typical Performance – Large Signal**

Test conditions unless otherwise noted: 5V and 3V, 25 °C

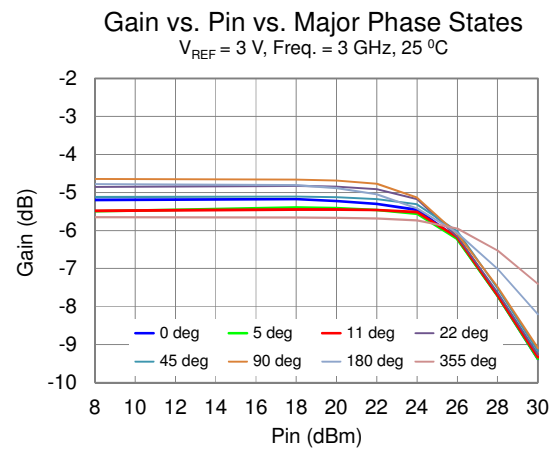
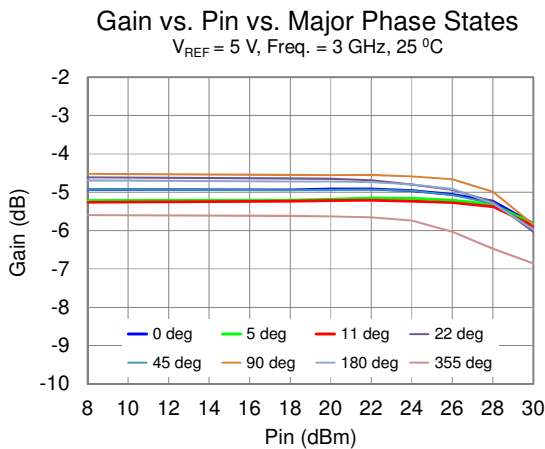
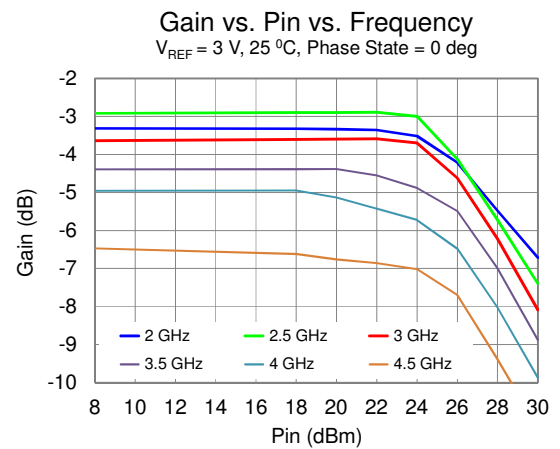
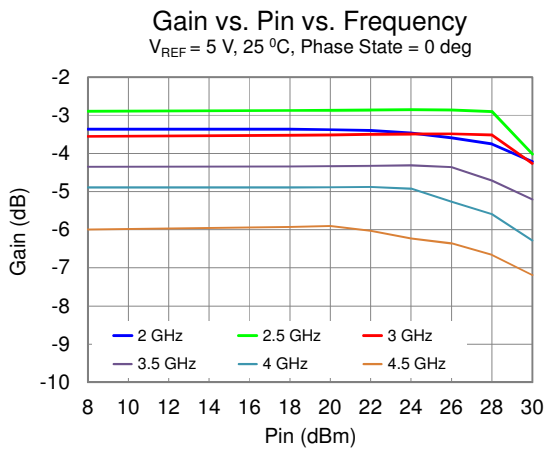
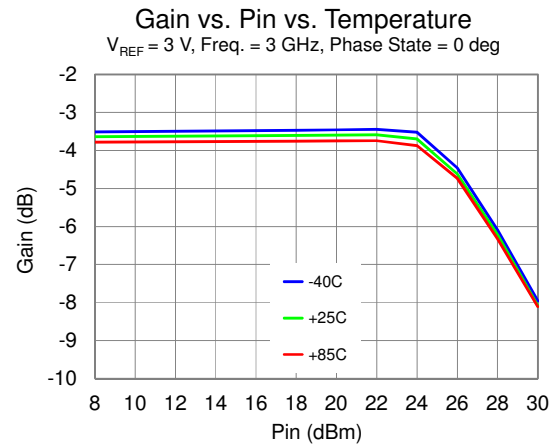
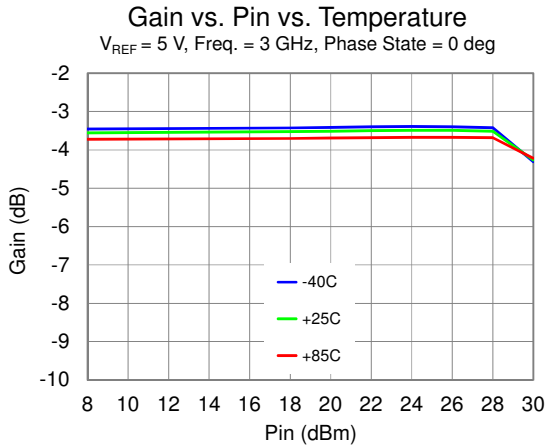

**Typical Performance – Large Signal (Cont.)**

Test conditions unless otherwise noted: 5V and 3V, 25 °C

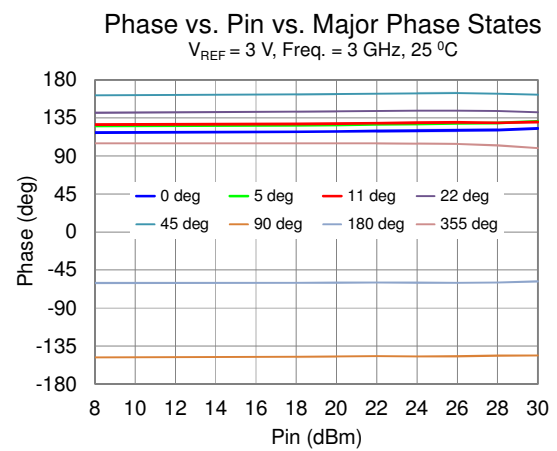
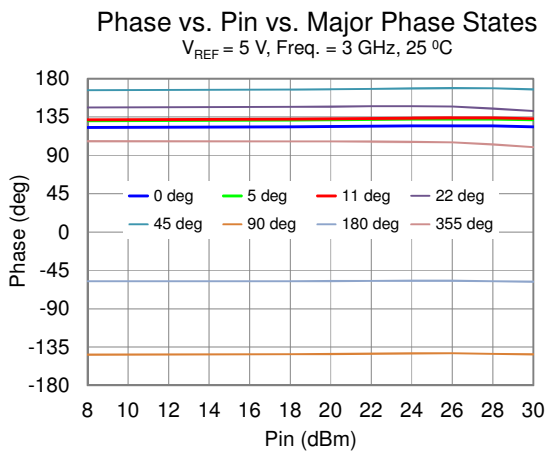
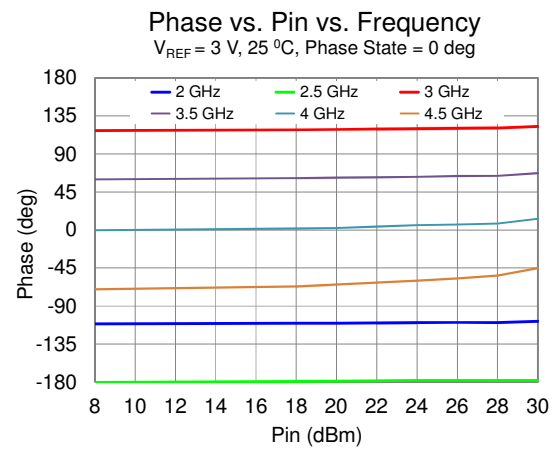
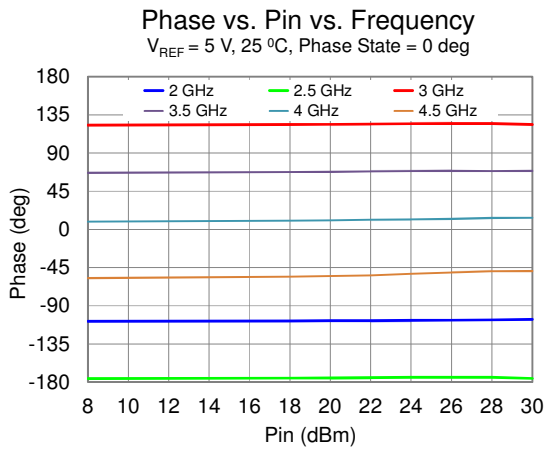
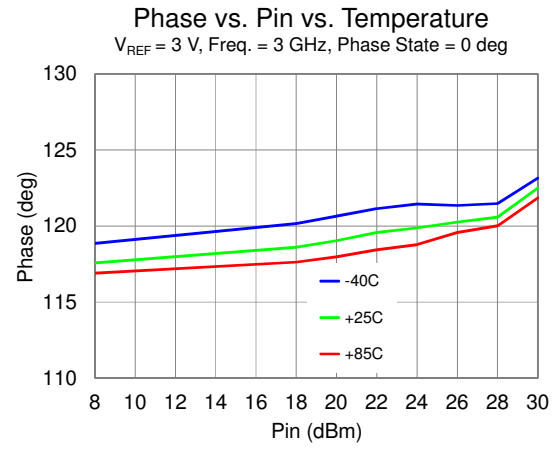
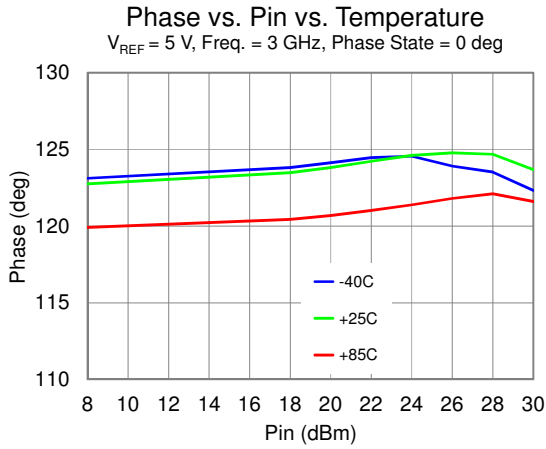



**Typical Performance – Large Signal (Cont.)**

Test conditions unless otherwise noted: 5V and 3V, 25 °C

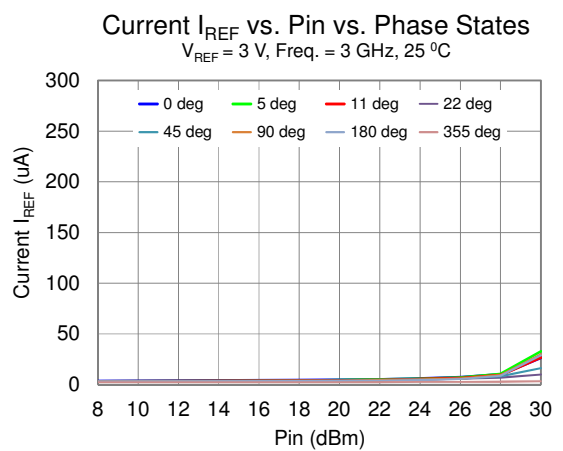
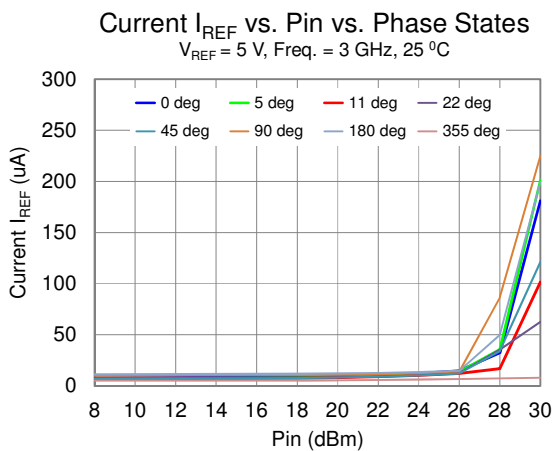
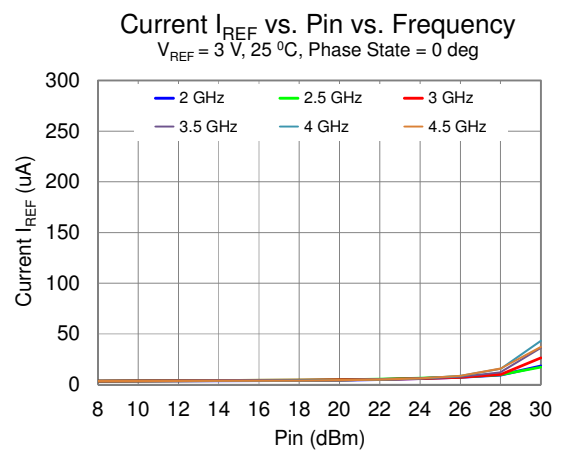
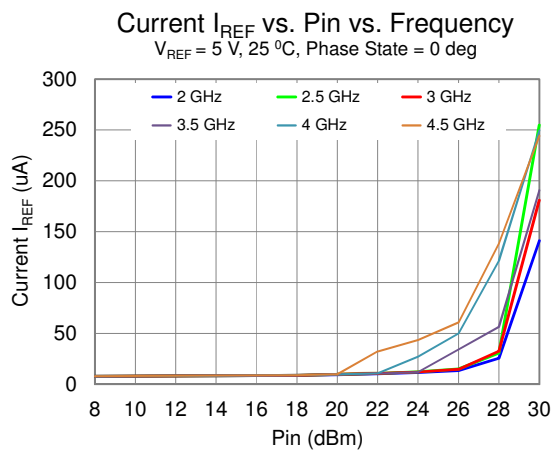
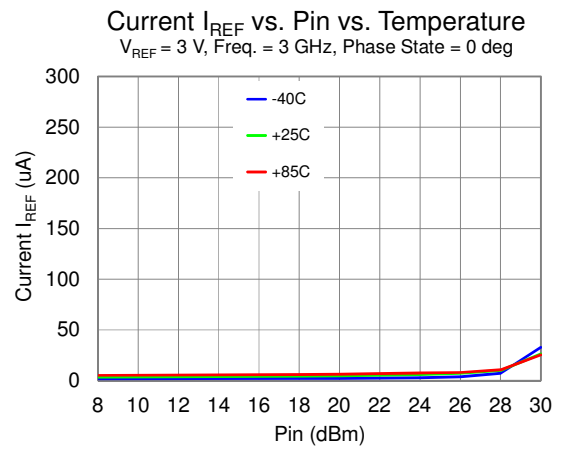
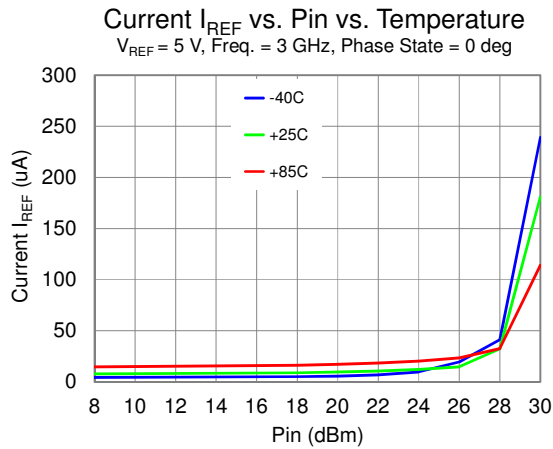

**Typical Performance – Linearity**

Test conditions unless otherwise noted: 5V and 3V, Tone Spacing = 10 MHz, 25 °C

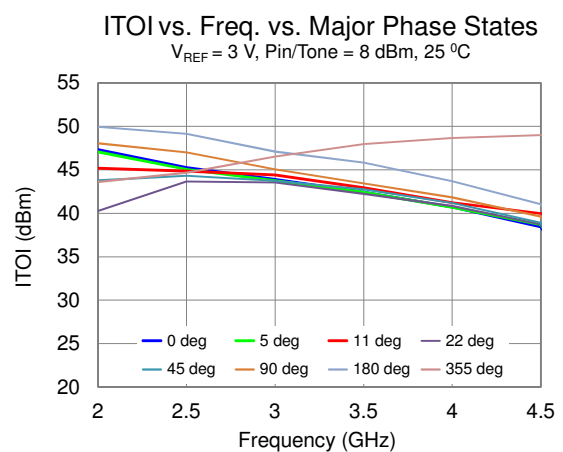
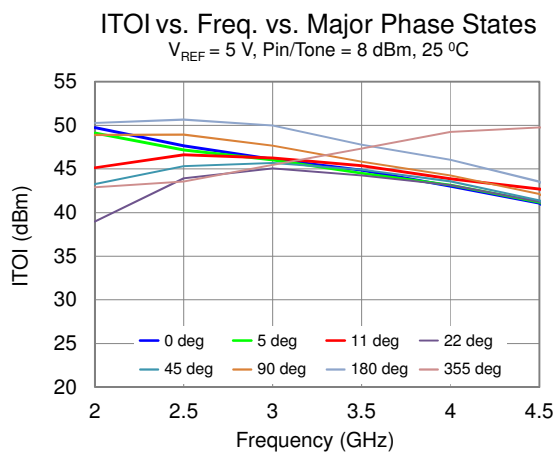
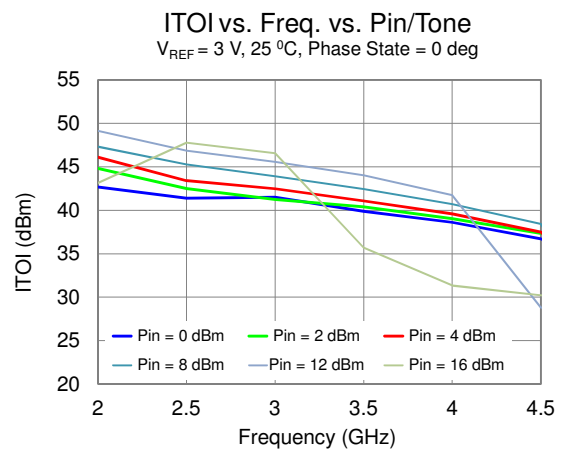
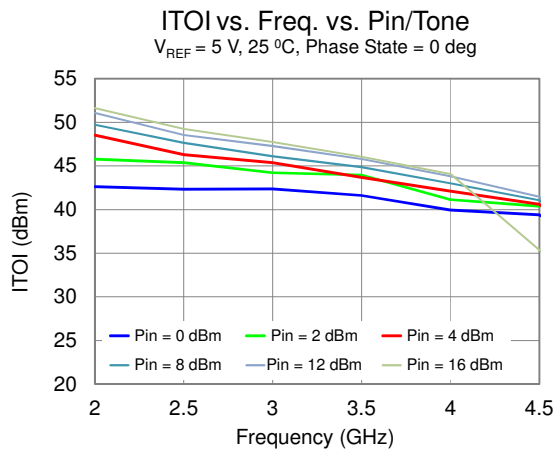
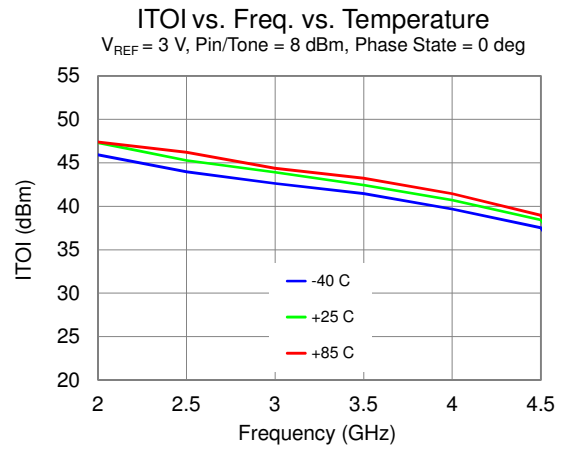
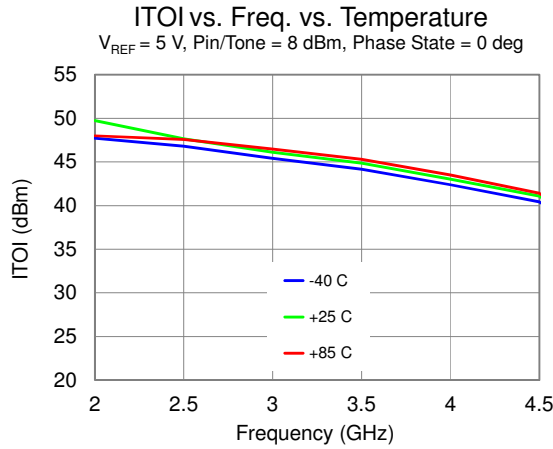

**Typical Performance – Linearity (Cont.)**

Test conditions unless otherwise noted: 5V and 3V, Tone Spacing = 10 MHz, 25 °C

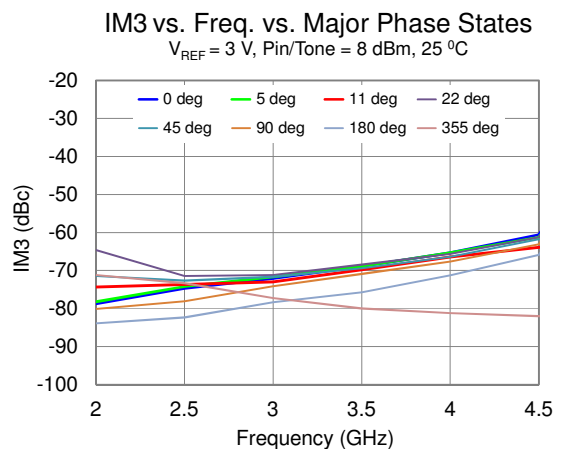
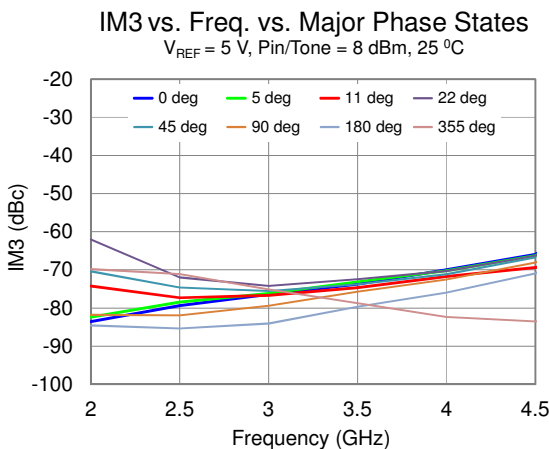
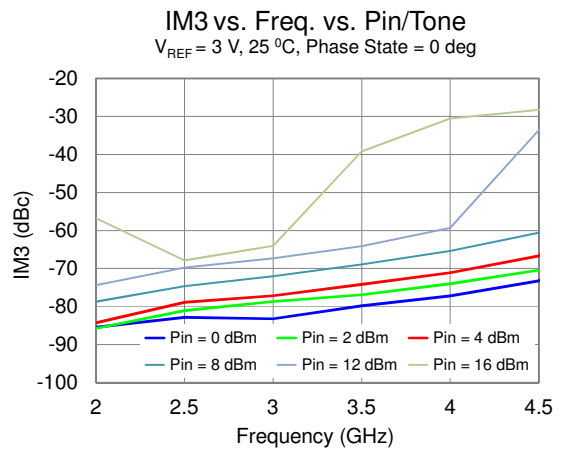
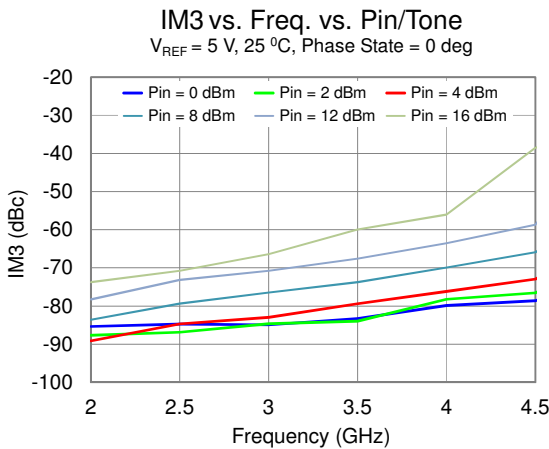
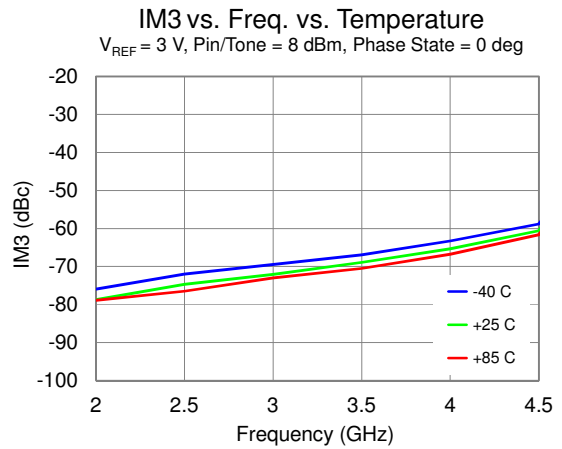
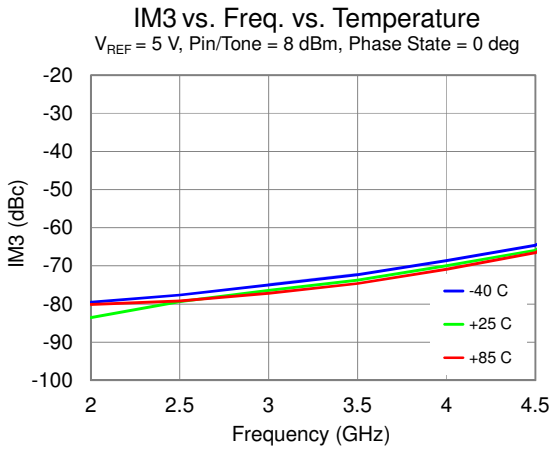

**Applications Information**

De-Quing network is not required

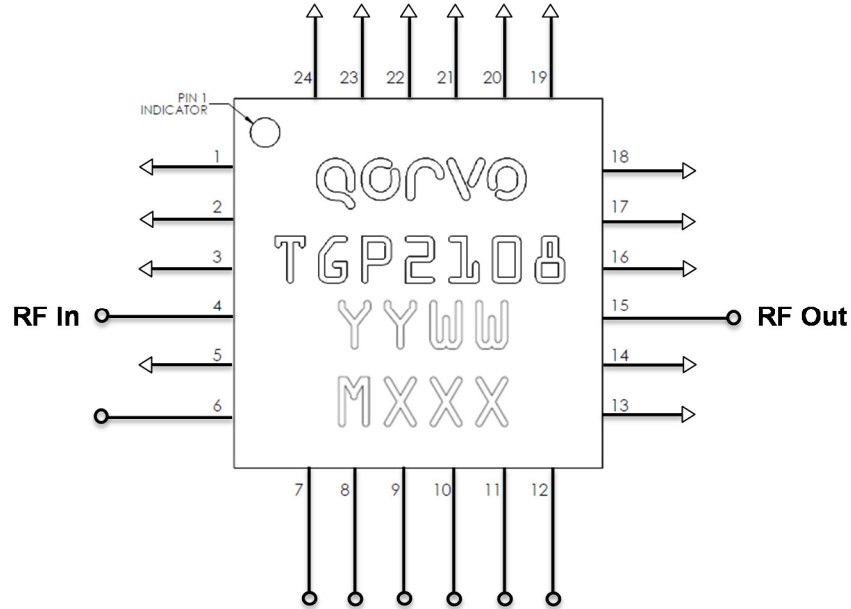

**Evaluation Board**

RF layer is 0.008" thick Rogers RO4003C. Metal layers are 0.5-oz copper. Microstrip 50 Ω line width is 0.050". The microstrip line taper at the connector interface is optimized for the Southwest Microwave end-launch connector 1092-02A-5.

Ground / thermal vias under the DUT are critical for the proper performance of this device. The PCB shown herein utilizes copper filled vias (8 mils diameter) under the DUT.

The pad pattern shown has been developed and tested for optimized assembly at TriQuint Semiconductor. The PCB land pattern has been developed to accommodate lead and package tolerances. Since surface mount processes vary from company to company, careful process development is recommended.

Vias Pattern

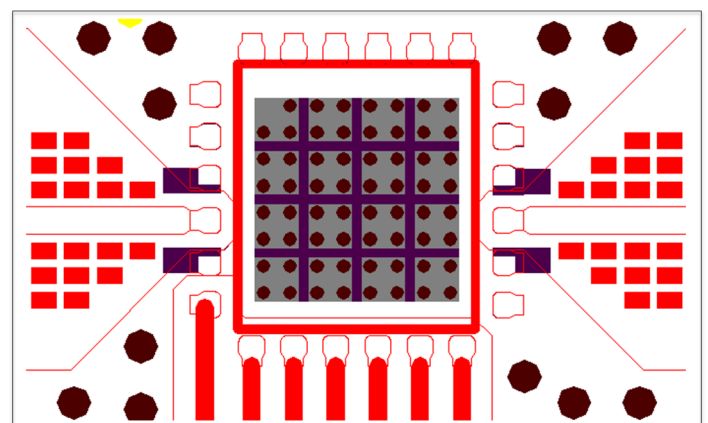
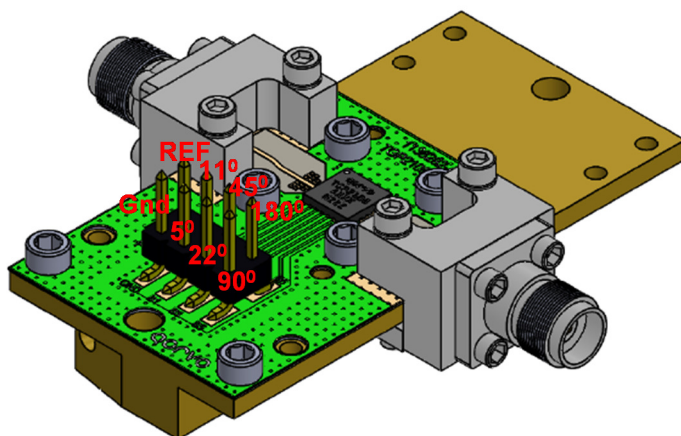

**Pin Description**

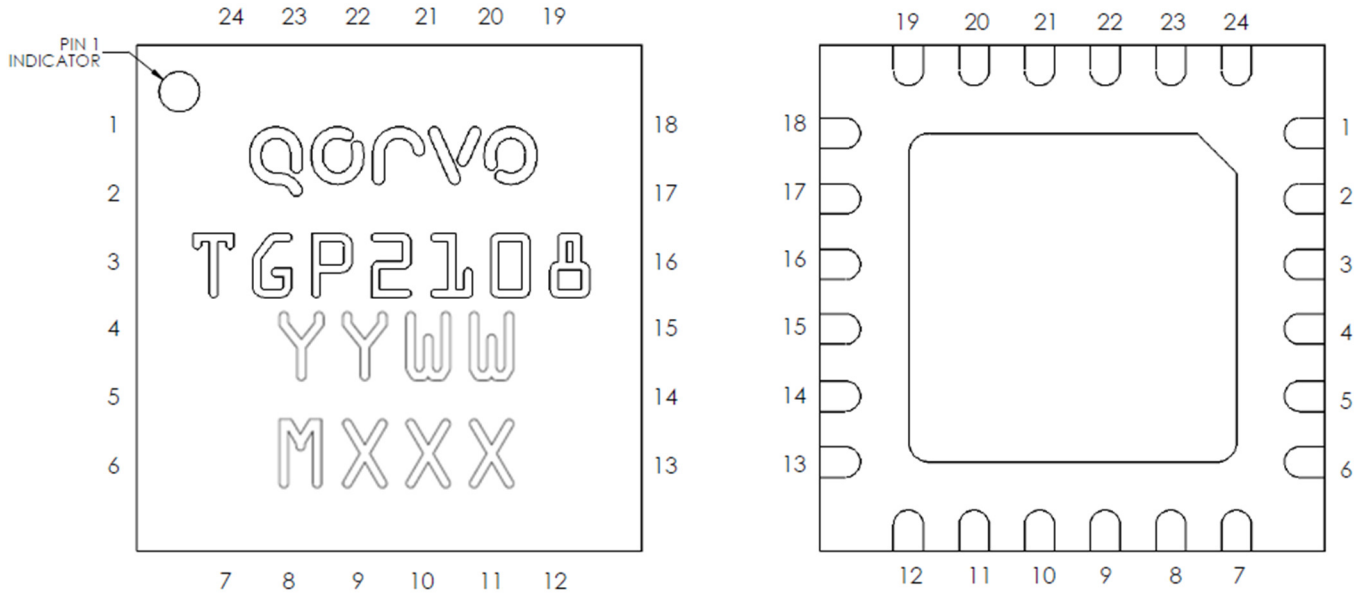

Package Pad	Symbol	Description
1-3, 5, 13-14, 16-24	N/C	No Connection; recommend GND at the EVB level
4	RF Input	Input; matched to 50 Ohms; DC blocked; interchangeable to RF Output
6	REF	Reference
7	5°	5° Bit
8	11°	11° Bit
9	22°	22° Bit
10	45°	45° Bit
11	90°	90° Bit
12	180°	180° Bit
15	RF Output	Output; matched to 50 Ohms; DC blocked; interchangeable to RF Input
25 (Slug)	GND	On PCB; multiple vias should be employed under the center pad (25) to minimize inductance and thermal resistance; see page 12 for suggested vias layout

**Mechanical Information**

**Package Information and Dimensions**

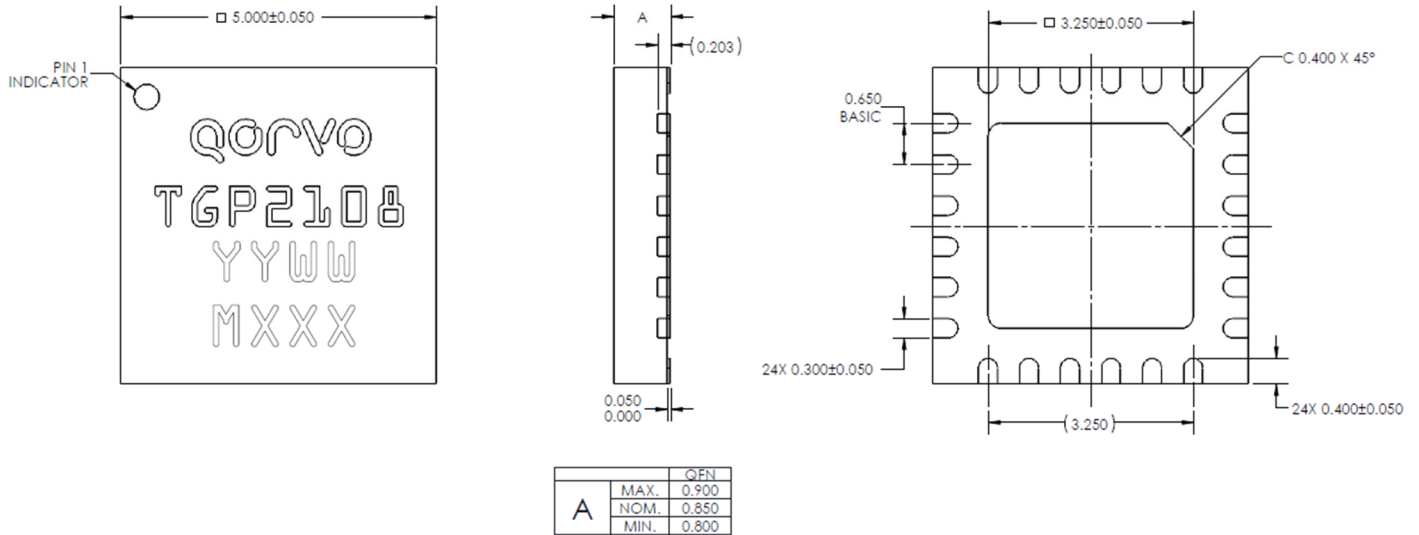

Units: mm

Tolerances: unless specified

.xx = ± 0.25

.xxx = ± 0.127

Materials:

Lid: Plastic

Plating: All metalized features are NiPdAu plated

Part is lead-free/PoHS-compliant; epoxy sealed

Marking:

2108: Part number

XXX: Assembly number

ZZZ: Serial number

**Recommended Soldering Temperature Profile**

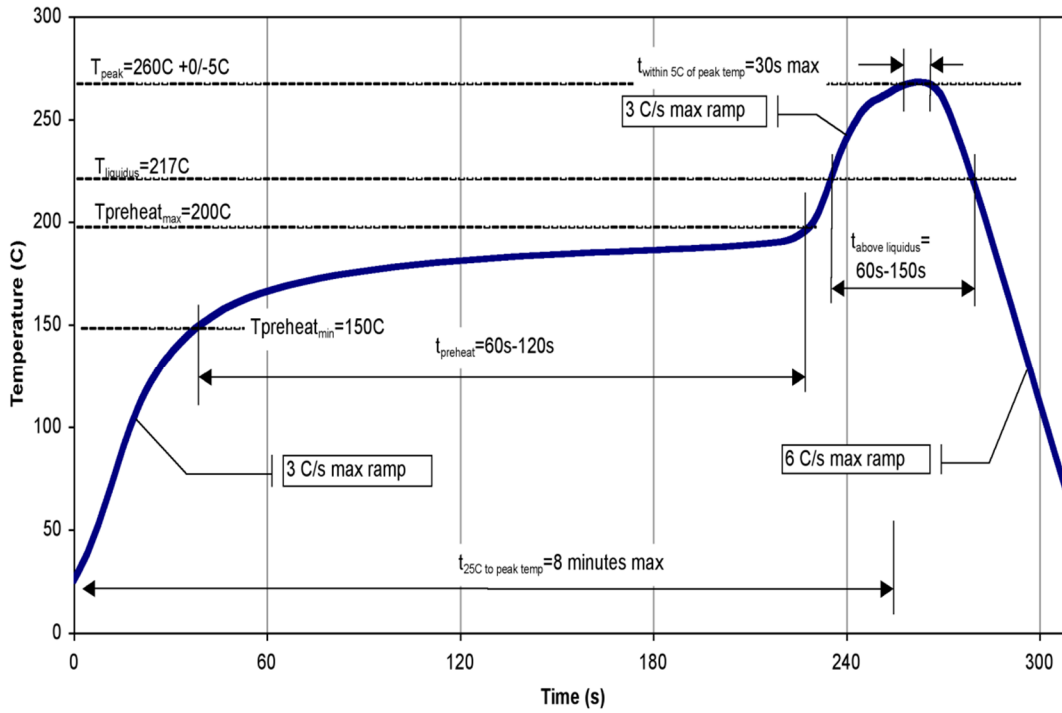

**Epoxies Attachment Notes:**

- Epoxies can be used.
- Epoxies cure at temperatures of 100 to 200 °C.

## Product Compliance Information

### ESD Sensitivity Ratings



Caution! ESD-Sensitive Device

ESD Rating: TBD  
Value: TBD  
Test: Human Body Model (HBM)  
Standard: JEDEC Standard JESD22-A114

### ECCN

U.S. Department of Commerce: EAR99

### Solderability

Compatible with the latest version of J-STD-020 Lead free solder, 260 °C.

### MSL Rating

TBD at 260 °C convection reflow  
The part is rated Moisture Sensitivity Level TBD  
JEDEC standard IPC/JEDEC J-STD-020.

### RoHS Compliance

This part is compliant with EU 2002/95/EC RoHS directive (Restrictions on the Use of Certain Hazardous Substances in Electrical and Electronic Equipment).

This product also has the following attributes:

- Lead Free
- Halogen Free (Chlorine, Bromine)
- Antimony Free
- TBBP-A (C<sub>15</sub>H<sub>12</sub>Br<sub>4</sub>O<sub>2</sub>) Free
- PFOS Free
- SVHC Free

## Contact Information

For the latest specifications, additional product information, worldwide sales and distribution locations, and information about TriQuint:

**Web:** [www.Qorvo.com](http://www.Qorvo.com) **Tel:** +1.972.994.8465  
**Email:** [info-sales@Qorvo.com](mailto:info-sales@Qorvo.com) **Fax:** +1.972.994.8504

## Important Notice

The information contained herein is believed to be reliable. Qorvo makes no warranties regarding the information contained herein. Qorvo assumes no responsibility or liability whatsoever for any of the information contained herein. Qorvo assumes no responsibility or liability whatsoever for the use of the information contained herein. The information contained herein is provided "AS IS, WHERE IS" and with all faults, and the entire risk associated with such information is entirely with the user. All information contained herein is subject to change without notice. Customers should obtain and verify the latest relevant information before placing orders for Qorvo products. The information contained herein or any use of such information does not grant, explicitly or implicitly, to any party any patent rights, licenses, or any other intellectual property rights, whether with regard to such information itself or anything described by such information.

Qorvo products are not warranted or authorized for use as critical components in medical, life-saving, or life-sustaining applications, or other applications where a failure would reasonably be expected to cause severe personal injury or death.





## Стандарт Электрон Связь

Мы молодая и активно развивающаяся компания в области поставок электронных компонентов. Мы поставляем электронные компоненты отечественного и импортного производства напрямую от производителей и с крупнейших складов мира.

Благодаря сотрудничеству с мировыми поставщиками мы осуществляем комплексные и плановые поставки широчайшего спектра электронных компонентов.

Собственная эффективная логистика и склад в обеспечивает надежную поставку продукции в точно указанные сроки по всей России.

Мы осуществляем техническую поддержку нашим клиентам и предпродажную проверку качества продукции. На все поставляемые продукты мы предоставляем гарантию .

Осуществляем поставки продукции под контролем ВП МО РФ на предприятия военно-промышленного комплекса России , а также работаем в рамках 275 ФЗ с открытием отдельных счетов в уполномоченном банке. Система менеджмента качества компании соответствует требованиям ГОСТ ISO 9001.

Минимальные сроки поставки, гибкие цены, неограниченный ассортимент и индивидуальный подход к клиентам являются основой для выстраивания долгосрочного и эффективного сотрудничества с предприятиями радиоэлектронной промышленности, предприятиями ВПК и научно-исследовательскими институтами России.

С нами вы становитесь еще успешнее!

### Наши контакты:

**Телефон:** +7 812 627 14 35

**Электронная почта:** [sales@st-electron.ru](mailto:sales@st-electron.ru)

**Адрес:** 198099, Санкт-Петербург,  
Промышленная ул, дом № 19, литера Н,  
помещение 100-Н Офис 331