

**HLMP-3707, HLMP-3907, HLMP-3750, HLMP-3850,
HLMP-3950, HLMP-3960, HLMP-3390, HLMP-3490,
HLMP-3590, HLMP-1340, HLMP-1440, HLMP-1540,
HLMP-K640**

T-13/4 (5 mm), T-1 (3 mm), Ultra-Bright LED Lamps



Data Sheet



Description

These non-diffused lamps out-perform conventional LED lamps. By utilizing new higher intensity material, we achieve superior product performance.

The HLMP-3750/-3390/-1340 Series Lamps are Gallium Arsenide Phosphide on Gallium Phosphide red light emitting diodes. The HLMP-3850/-3490/-1440 Series are Gallium Arsenide Phosphide on Gallium Phosphide yellow light emitting diodes. The HLMP-3950/3590/3960/1540/K640 Series Lamps are Gallium Phosphide green light emitting diodes.

Features

- Improved brightness
- Improved color performance
- Available in popular T-1 and T-1³/₄ packages
- New sturdy leads
- IC compatible/low current capability
- Reliable and rugged
- Choice of 3 bright colors
 - High Efficiency Red
 - High Brightness Yellow
 - High Performance Green

Applications

- Lighted switches
- Backlighting front panels
- Light pipe sources
- Keyboard indicators

Selection Guide

Package Description	Color	Luminous Intensity Iv (mcd) @ 20mA				2q1/2 Degree	Package Outline
		Device HLMP-	Min.	Typ.	Max.		
T-1 ^{3/4}	Red	3707-L00xx	90.2	-	-	24	F
		3750	90.2	125.0	-	24	A
		3750-L00xx	90.2	125.0	-	24	A
	Yellow	3850	96.2	140.0	-	24	A
		3850-K00xx	96.2	140.0	-	24	A
		3850-KL0xx	96.2	150.0	294.0	24	A
	Green	3907-K00xx	111.7	-	-	24	F
		3914-K00xx	111.7	-	-	24	D
		3950	111.7	265.0	-	24	A
3950-K00xx		111.7	265.0	-	24	A	
3950-LM0xx		170.0	300.0	490.0	24	A	
3960-K0xxx		111.7	265.0	-	24	E	
T-1 ^{3/4} Low Profile	Red	3390	35.2	55.0	-	32	B
	Yellow	3490	37.6	55.0	-	32	B
	Green	3590	43.6	55.0	-	32	B
T-1	Red	1340	35.2	55.0	-	45	C
		1340-H00xx	13.8	-	-	45	C
		1340-J00xx	35.2	55.0	-	45	C
	Yellow	1440	23.5	45.0	-	45	C
		1440-H00xx	23.5	45.0	-	45	C
	Green	1540	27.3	45.0	-	45	C
		1540-H00xx	27.3	45.0	-	45	C
		1540-IJ0xx	43.6	60.0	139.6	45	C
	Emerald Green	K640	4.2	21.0	-	45	C
K640-FGNxx		10.6	20.0	34.0	45	C	

Package Dimensions

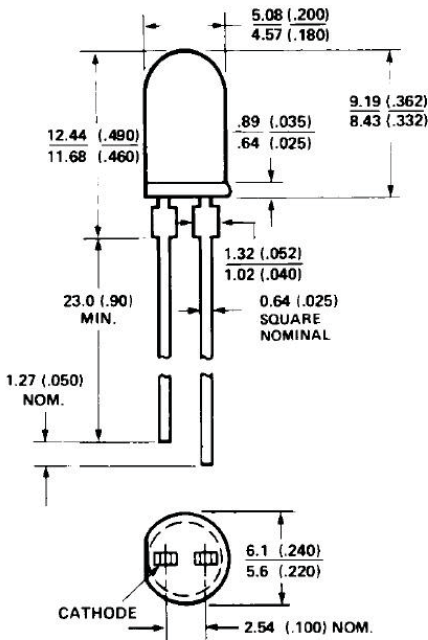

PACKAGE OUTLINE "A"
HLMP-3750, -3850, -3950

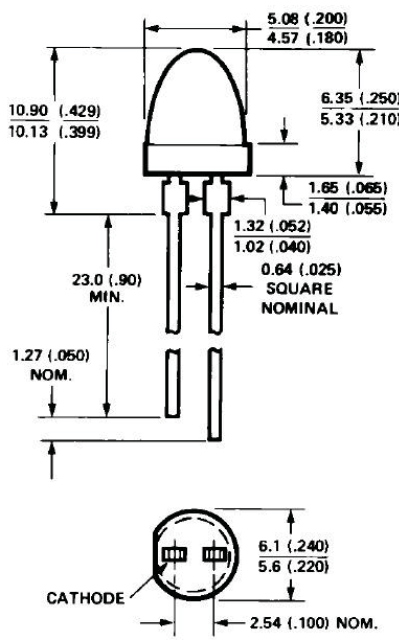

PACKAGE OUTLINE "B"
HLMP-3390, -3490, -3590

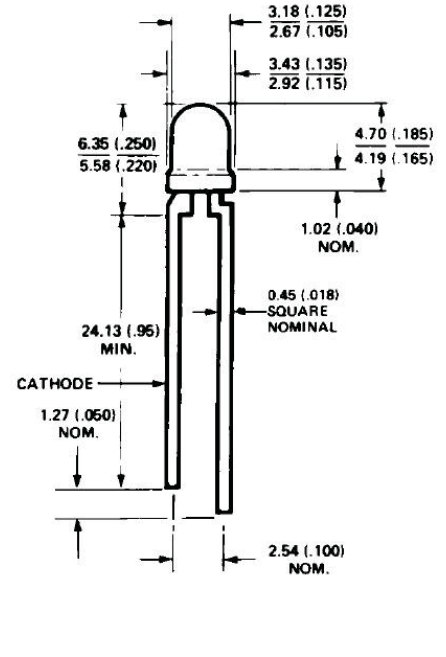

PACKAGE OUTLINE "C"
HLMP-1340, -1440, -1540

NOTES:
 1. ALL DIMENSIONS ARE IN MILLIMETERS (INCHES).
 2. AN EPOXY MENISCUS MAY EXTEND ABOUT 1 mm (0.40") DOWN THE LEADS.

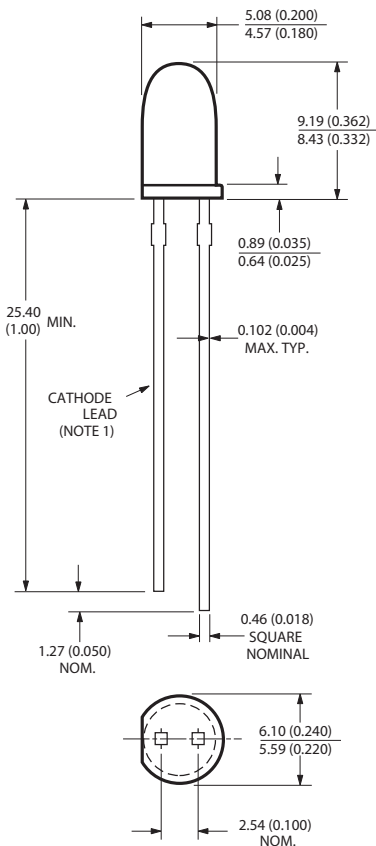

PACKAGE OUTLINE "D"
HLMP-3914

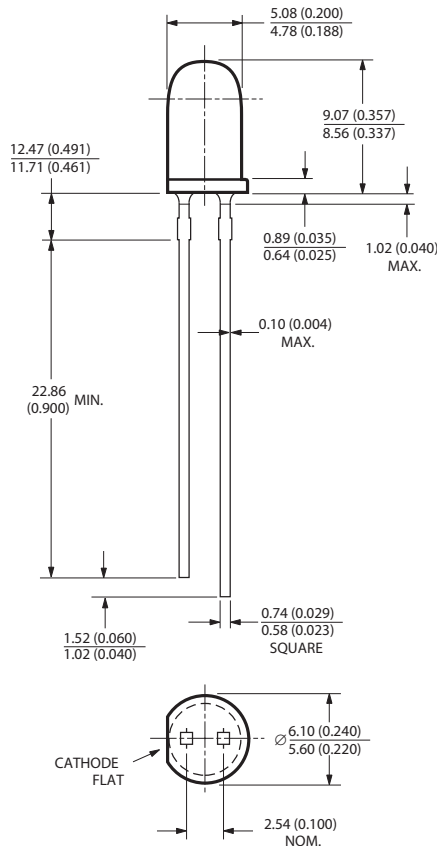

PACKAGE OUTLINE "E"
HLMP-3960

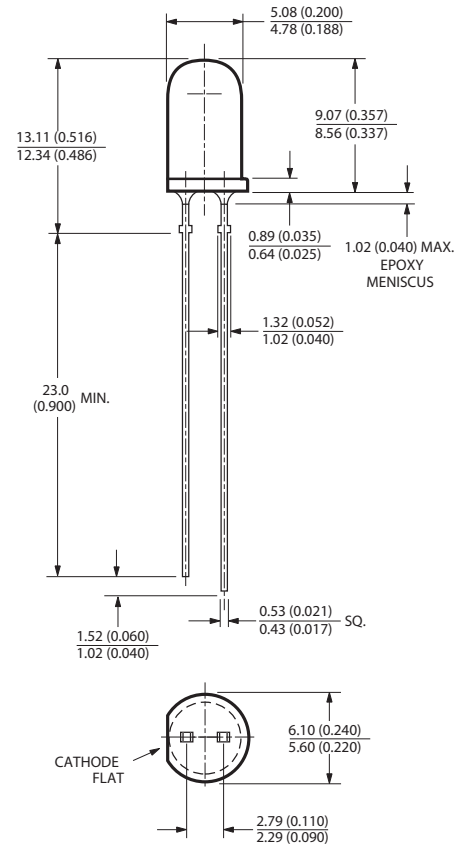

PACKAGE OUTLINE "F"
HLMP-3707/3907

Part Numbering System

HLMP - x x xx - x x x xx

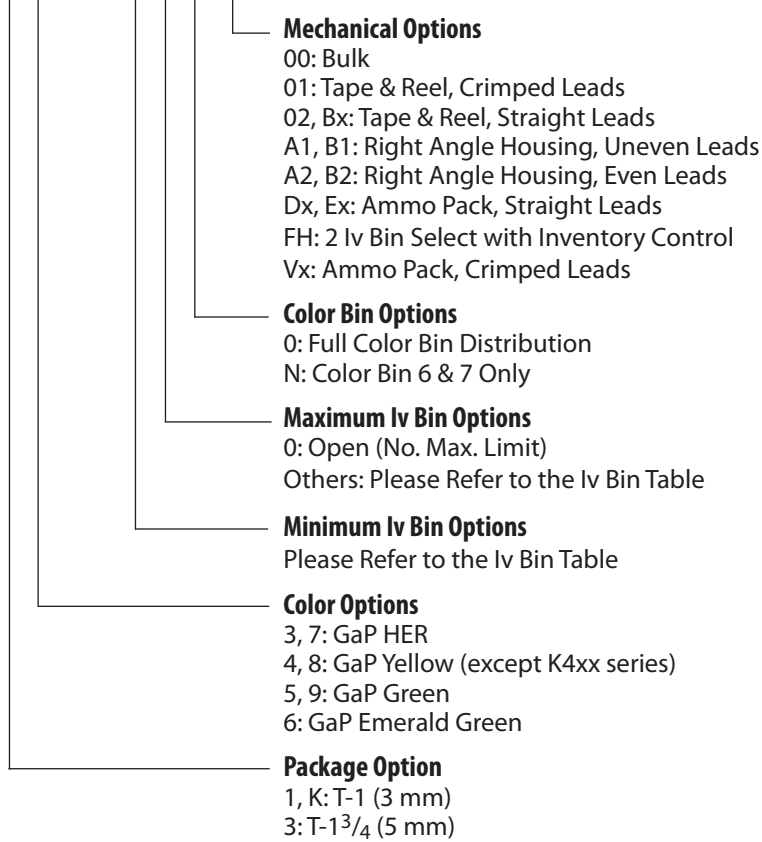

Absolute Maximum Ratings at $T_A = 25^\circ\text{C}$

Parameter	Red	Yellow	Green/Emerald Green	Units
Peak Forward Current	90	60	90	mA
Average Forward Current ^[1]	25	20	25	mA
DC Current ^[2]	30	20	30	mA
Transient Forward Current ^[3] (10 μs Pulse)	500	500	500	mA
Reverse Voltage ($I_R = 100 \mu\text{A}$)	5	5	5	V
LED Junction Temperature	110	110	110	$^\circ\text{C}$
Operating Temperature Range	-40 to +100	-40 to +100	-20 to +100	$^\circ\text{C}$
Storage Temperature Range	-40 to +100	-40 to +100	-40 to +100	$^\circ\text{C}$

Notes:

- See Figure 2 to establish pulsed operating conditions.
- For Red and Green series derate linearly from 50°C at $0.5 \text{ mA}/^\circ\text{C}$. For Yellow series derate linearly from 50°C at $0.2 \text{ mA}/^\circ\text{C}$.
- The transient peak current is the maximum non-recurring peak current the devices can withstand without damaging the LED die and wire bonds. It is not recommended that the device be operated at peak currents beyond the Absolute Maximum Peak Forward Current.

Electrical/Optical Characteristics at $T_A = 25^\circ\text{C}$

Symbol	Description	T-1 ^{3/4}	T-1 ^{3/4} Low Dome	T-1	Min.	Typ.	Max.	Units	Test Conditions
λ_{PEAK}	Peak Wavelength	37xx	3390	1340		635		nm	Measurement at Peak
		38xx	3490	1440		583			
		39xx	3590	1540		565			
				K640		558			
λ_d	Dominant Wavelength	37xx	3390	1340		626		nm	Note 1
		38xx	3490	1440		585			
		39xx	3590	1540		569			
				K640		560			
$\Delta\lambda^{3/4}$	Spectral Line Halfwidth	37xx	3390	1340		40		nm	
		38xx	3490	1440		36			
		39xx	3590	1540		28			
				K640		24			
τ_s	Speed of Respond	37xx	3390	1340		90		ns	
		38xx	3490	1440		90			
		39xx	3590	1540		500			
				K640		3100			
C	Capacitance	37xx	3390	1340		11		pF	$V_F = 0$, $f = 1 \text{ MHz}$
		38xx	3490	1440		15			
		39xx	3590	1540		18			
				K640		35			
$R\theta_{\text{J-PIN}}$	Thermal Resistance	37xx	3390			210		$^\circ\text{C/W}$	Junction to Cathode Lead
		38xx	3490			210			
		39xx	3590			210			
						510			
					1340	290			
					1440	290			
					1540	290			
			K640	290					
V_F	Forward Voltage	37xx	3390	1340	1.5	1.9	2.6	V	$I_F = 20 \text{ mA}$ (Figure 3)
		38xx	3490	1440	1.5	2.1	2.6		
		39xx	3590	1540	1.5	2.2	3.0		
				K640		2.2	3.0		
V_R	Reverse Breakdown Voltage	37xx	3390	1340	5.0			V	$I_F = 100 \mu\text{A}$
		38xx	3490	1440					
		39xx	3590	1540					
				K640					
η_V	Luminous Efficacy	37xx	3390	1340		145		<u>lumens</u> watt	Note 2
		38xx	3490	1440		500			
		39xx	3590	1540		595			
				K640		655			

Notes:

1. The dominant wavelength, λ_d , is derived from the CIE chromaticity diagram and represents the single wavelength which defines the color of the device.
2. The radiant intensity, I_e , in watts per steradian, may be found from the equation $I_e = IV/\eta_V$, where IV is the luminous intensity in candelas and η_V is the luminous efficacy in lumens/watt.

Red, Yellow, and Green

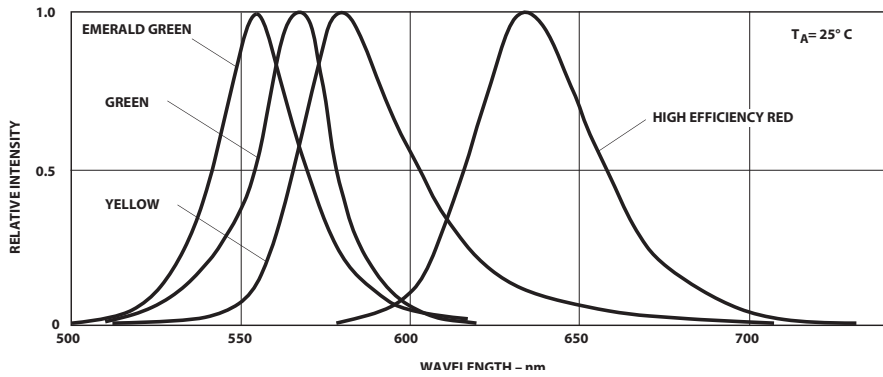

Figure 1. Relative intensity vs. wavelength.

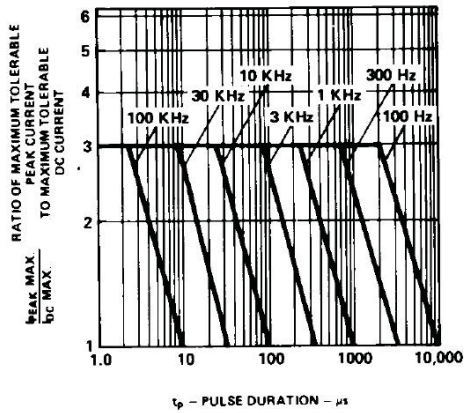

Figure 2. Maximum tolerable peak current vs. pulse duration. (I_{DC} MAX as per MAX ratings).

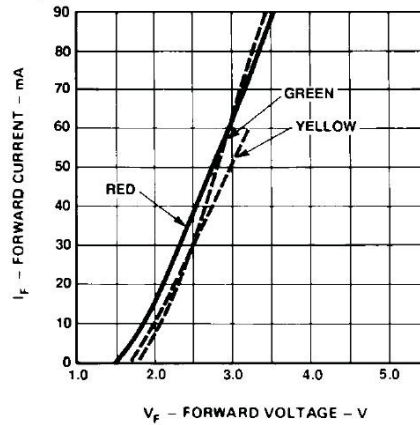

Figure 3. Forward current vs. forward voltage.

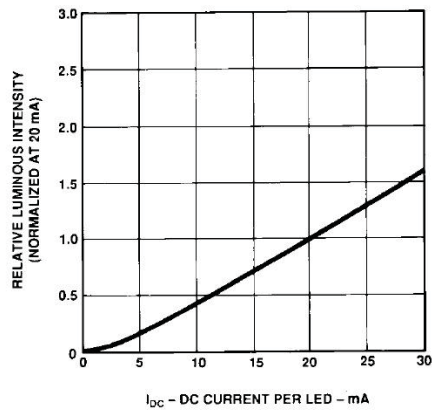

Figure 4. Relative luminous intensity vs. forward current.

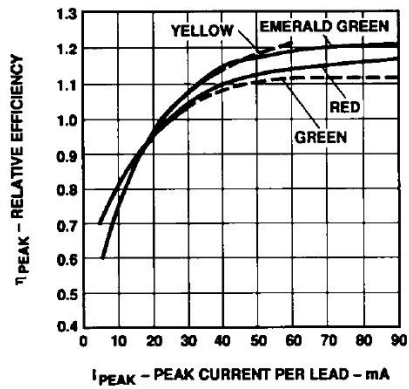

Figure 5. Relative efficiency (luminous intensity per unit current) vs. peak current.

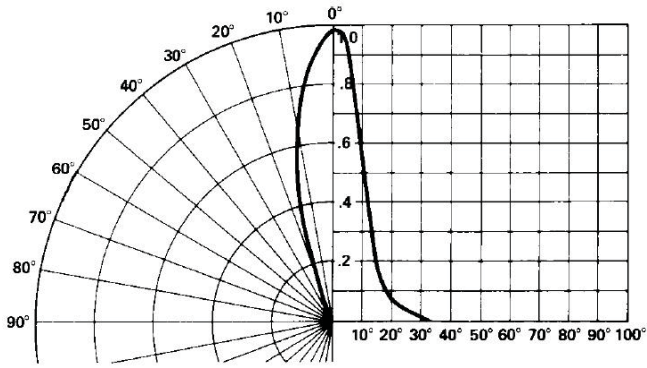

Figure 6. Relative luminous intensity vs. angular displacement. T-1^{3/4} lamp.

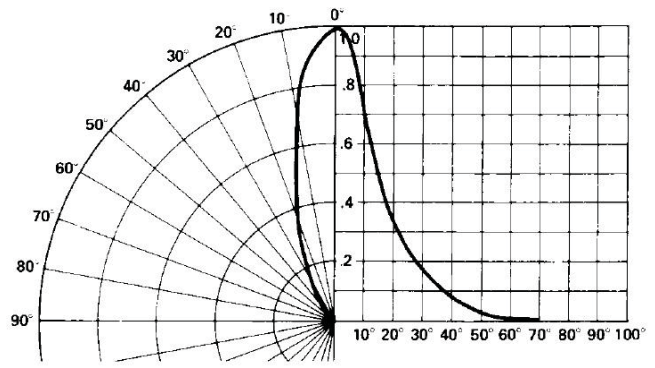

Figure 7. Relative luminous intensity vs. angular displacement. T-1^{3/4} low profile lamp.

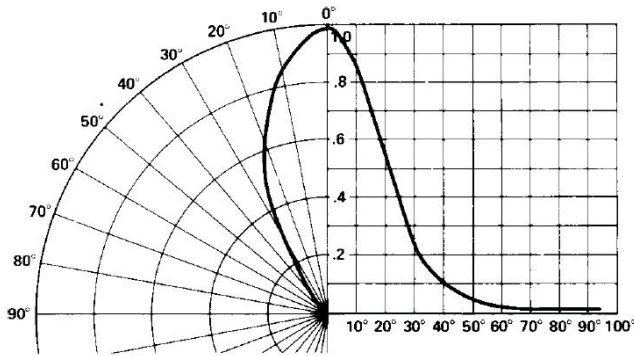

Figure 8. Relative luminous intensity vs. angular displacement. T-1 lamp.

Intensity Bin Limits

Color	Bin	Intensity Range (mcd)	
		Min.	Max.
Red	G	9.7	15.5
	H	15.5	24.8
	I	24.8	39.6
	J	39.6	63.4
	K	63.4	101.5
	L	101.5	162.4
	M	162.4	234.6
	N	234.6	340.0
	O	340.0	540.0
	P	540.0	850.0
	Q	850.0	1200.0
	R	1200.0	1700.0
	S	1700.0	2400.0
	T	2400.0	3400.0
	U	3400.0	4900.0
	V	4900.0	7100.0
W	7100.0	10200.0	
X	10200.0	14800.0	
Y	14800.0	21400.0	
Z	21400.0	30900.0	

Maximum tolerance for each bin limit is ±18%.

Intensity Bin Limits (continued)

Color	Bin	Intensity Range (mcd)	
		Min.	Max.
Yellow	F	10.3	16.6
	G	16.6	26.5
	H	26.5	42.3
	I	42.3	67.7
	J	67.7	108.2
	K	108.2	173.2
	L	173.2	250.0
	M	250.0	360.0
	N	360.0	510.0
	O	510.0	800.0
	P	800.0	1250.0
	Q	1250.0	1800.0
	R	1800.0	2900.0
	S	2900.0	4700.0
	T	4700.0	7200.0
	U	7200.0	11700.0
	V	11700.0	18000.0
W	18000.0	27000.0	
Green/ Emerald	A	1.1	1.8
Green	B	1.8	2.9
	C	2.9	4.7
	D	4.7	7.6
	E	7.6	12.0
	F	12.0	19.1
	G	19.1	30.7
	H	30.7	49.1
	I	49.1	78.5
	J	78.5	125.7
	K	125.7	201.1
	L	201.1	289.0
	M	289.0	417.0
	N	417.0	680.0
	O	680.0	1100.0
	P	1100.0	1800.0
	Q	1800.0	2700.0
	R	2700.0	4300.0
S	4300.0	6800.0	
T	6800.0	10800.0	
U	10800.0	16000.0	
V	16000.0	25000.0	
W	25000.0	40000.0	

Maximum tolerance for each bin limit is $\pm 18\%$.

Color Categories

Color	Cat #	Lambda (nm)	
		Min.	Max.
Emerald Green	9	552.5	555.5
	8	555.5	558.5
	7	558.5	561.5
	6	561.5	564.5
Green	6	561.5	564.5
	5	564.5	567.5
	4	567.5	570.5
	3	570.5	573.5
Yellow	2	573.5	576.5
	1	582.0	584.5
	3	584.5	587.0
	2	587.0	589.5
Orange	4	589.5	592.0
	5	592.0	593.0
	1	597.0	599.5
	2	599.5	602.0
	3	602.0	604.5
	4	604.5	607.5
	5	607.5	610.5
	6	610.5	613.5
	7	613.5	616.5
	8	616.5	619.5

Maximum tolerance for each bin limit is ± 0.5 nm.

Mechanical Option Matrix

Mechanical Option Code	Definition
00	Bulk Packaging, minimum increment 500 pcs/bag
01	Tape & Reel, crimped leads, min. increment 1300 pcs/bag for T-1 ^{3/4} , 1800 pcs/bag for T-1
02	Tape & Reel, straight leads, min. increment 1300 pcs/bag for T-1 ^{3/4} , 1800 pcs/bag for T-1
A1	T-1, Right Angle Housing, uneven leads, minimum increment 500 pcs/bag
A2	T-1, Right Angle Housing, even leads, minimum increment 500 psc/bag
B1	T-1 ^{3/4} , Right Angle Housing, uneven leads, minimum increment 500 pcs/bag
B2	T-1 ^{3/4} , Right Angle Housing, even leads, minimum increment 500 psc/bag
BJ	T-1, Tape & Reel, straight leads, minimum increment 2000 pcs/bag
EG	Ammo Pack, straight leads in 5 K increment
FH	Devices that require inventory control and 2 I _v bin select
VR	Ammo Pack, crimped leads, min. increment 2 k for T-1 ^{3/4} and T-1

Note:

All categories are established for classification of products. Products may not be available in all categories. Please contact your local Avago representative for further clarification/information.

Precautions:

Lead Forming:

- The leads of an LED lamp may be preformed or cut to length prior to insertion and soldering on PC board.
- For better control, it is recommended to use proper tool to precisely form and cut the leads to applicable length rather than doing it manually.
- If manual lead cutting is necessary, cut the leads after the soldering process. The solder connection forms a mechanical ground which prevents mechanical stress due to lead cutting from traveling into LED package. This is highly recommended for hand solder operation, as the excess lead length also acts as small heat sink.

Soldering and Handling:

- Care must be taken during PCB assembly and soldering process to prevent damage to the LED component.
- LED component may be effectively hand soldered to PCB. However, it is only recommended under unavoidable circumstances such as rework. The closest manual soldering distance of the soldering heat source (soldering iron's tip) to the body is 1.59mm. Soldering the LED using soldering iron tip closer than 1.59mm might damage the LED.

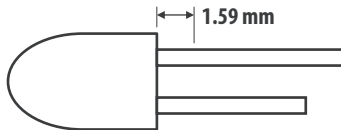

- ESD precaution must be properly applied on the soldering station and personnel to prevent ESD damage to the LED component that is ESD sensitive. Do refer to Avago application note AN 1142 for details. The soldering iron used should have grounded tip to ensure electrostatic charge is properly grounded.
- Recommended soldering condition:

	Wave Soldering ^{[1],[2]}	Manual Solder Dipping
Pre-heat Temperature	105°C Max.	–
Pre-heat Time	60 sec Max.	–
Peak Temperature	250°C Max.	260°C Max.
Dwell Time	3 sec Max.	5 sec Max.

Note:

1. Above conditions refers to measurement with thermocouple mounted at the bottom of PCB.
2. It is recommended to use only bottom preheaters in order to reduce thermal stress experienced by LED.

- Wave soldering parameters must be set and maintained according to the recommended temperature and dwell time. Customer is advised to perform daily check on the soldering profile to ensure that it is always conforming to recommended soldering conditions.

Note:

1. PCB with different size and design (component density) will have different heat mass (heat capacity). This might cause a change in temperature experienced by the board if same wave soldering setting is used. So, it is recommended to re-calibrate the soldering profile again before loading a new type of PCB.
 2. Customer is advised to take extra precaution during wave soldering to ensure that the maximum wave temperature does not exceed 250°C and the solder contact time does not exceeding 3sec. Over-stressing the LED during soldering process might cause premature failure to the LED due to delamination.
- Any alignment fixture that is being applied during wave soldering should be loosely fitted and should not apply weight or force on LED. Non metal material is recommended as it will absorb less heat during wave soldering process.
 - At elevated temperature, LED is more susceptible to mechanical stress. Therefore, PCB must allowed to cool down to room temperature prior to handling, which includes removal of alignment fixture or pallet.
 - If PCB board contains both through hole (TH) LED and other surface mount components, it is recommended that surface mount components be soldered on the top side of the PCB. If surface mount need to be on the bottom side, these components should be soldered using reflow soldering prior to insertion the TH LED.
 - Recommended PC board plated through holes (PTH) size for LED component leads.

LED Component Lead Size	Diagonal	Plated Through Hole Diameter
0.45 x 0.45 mm (0.018 x 0.018 inch)	0.636 mm (0.025 inch)	0.98 to 1.08 mm (0.039 to 0.043 inch)
0.50 x 0.50 mm (0.020 x 0.020 inch)	0.707 mm (0.028 inch)	1.05 to 1.15 mm (0.041 to 0.045 inch)

- Over-sizing the PTH can lead to twisted LED after clinching. On the other hand under sizing the PTH can cause difficulty inserting the TH LED.

Refer to application note AN5334 for more information about soldering and handling of TH LED lamps.

Example of Wave Soldering Temperature Profile for TH LED

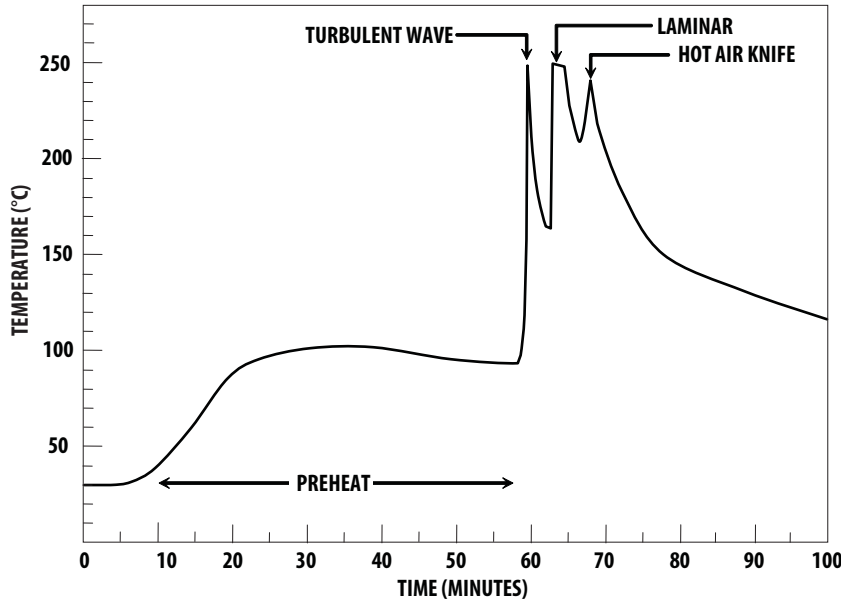

Recommended solder:
 Sn63 (Leaded solder alloy)
 SAC305 (Lead free solder alloy)

Flux: Rosin flux

Solder bath temperature:
 245°C ± 5°C (maximum peak temperature = 250°C)

Dwell time: 1.5 sec – 3.0 sec (maximum = 3sec)

Note: Allow for board to be sufficiently cooled to room temperature before exerting mechanical force.

Recommended solder:
 Sn63 (Leaded solder alloy)
 SAC305 (Lead free solder alloy)

Flux: Rosin flux













Solder bath temperature:
 245°C ± 5°C (maximum peak temperature = 250°C)

Dwell time: 1.5 sec – 3.0 sec (maximum = 3sec)

Note: Allow for board to be sufficiently cooled to room temperature before exerting mechanical force.

Packaging Label:

(i) Avago Mother Label: (Available on packaging box of ammo pack and shipping box)

 TECHNOLOGIES	
(1P) Item: Part Number	STANDARD LABEL LS0002
	RoHS Compliant
(1T) Lot: Lot Number	e3 max temp 250C
	(Q) QTY: Quantity
LPN:	
	CAT: Intensity Bin
(9D)MFG Date: Manufacturing Date	
	BIN: Color Bin
<hr/>	
(P) Customer Item:	
	
(V) Vendor ID:	(9D) Date Code: Date Code
	
<hr/>	
DeptID:	Made In: Country of Origin
	

(ii) Avago Baby Label (Only available on bulk packaging)

 Lamps Baby Label		RoHS Compliant e3 max temp 250C
(1P) PART #: Part Number 		
(1T) LOT #: Lot Number 		
(9D)MFG DATE: Manufacturing Date 	QUANTITY: Packing Quantity 	
C/O: Country of Origin		
Customer P/N: 	CAT: Intensity Bin 	
Supplier Code: 	BIN: Color Bin 	
	DATECODE: Date Code 	

For product information and a complete list of distributors, please go to our web site: www.avagotech.com

Avago, Avago Technologies, and the A logo are trademarks of Avago Technologies in the United States and other countries.
Data subject to change. Copyright © 2005-2010 Avago Technologies. All rights reserved. Obsoletes 5989-4254EN
AV02-1556EN - May 10, 2010





Стандарт Электрон Связь

Мы молодая и активно развивающаяся компания в области поставок электронных компонентов. Мы поставляем электронные компоненты отечественного и импортного производства напрямую от производителей и с крупнейших складов мира.

Благодаря сотрудничеству с мировыми поставщиками мы осуществляем комплексные и плановые поставки широчайшего спектра электронных компонентов.

Собственная эффективная логистика и склад в обеспечивает надежную поставку продукции в точно указанные сроки по всей России.

Мы осуществляем техническую поддержку нашим клиентам и предпродажную проверку качества продукции. На все поставляемые продукты мы предоставляем гарантию .

Осуществляем поставки продукции под контролем ВП МО РФ на предприятия военно-промышленного комплекса России , а также работаем в рамках 275 ФЗ с открытием отдельных счетов в уполномоченном банке. Система менеджмента качества компании соответствует требованиям ГОСТ ISO 9001.

Минимальные сроки поставки, гибкие цены, неограниченный ассортимент и индивидуальный подход к клиентам являются основой для выстраивания долгосрочного и эффективного сотрудничества с предприятиями радиоэлектронной промышленности, предприятиями ВПК и научно-исследовательскими институтами России.

С нами вы становитесь еще успешнее!

Наши контакты:

Телефон: +7 812 627 14 35

Электронная почта: sales@st-electron.ru

Адрес: 198099, Санкт-Петербург,
Промышленная ул, дом № 19, литера Н,
помещение 100-Н Офис 331