

# Series 51

## Characteristics

The compact 16mm Series 51 is particularly suited for applications in the areas:

- Flush design
- Raised design
- PCB (with adaptor)

The low level switching element is laid out for low current applications.

## Functions

The Series 51 incorporates the following functions:

- Indicator
- Pushbutton
- Illuminated pushbutton
- Stop switch
- Keylock switch
- Selector switch

## Market segments

The EAO Series 51 is especially suited for applications in the segments:

- Machinery and Automation
- Panel building

Please refer to the EAO website to obtain detailed information regarding this series [www.products.eao.com](http://www.products.eao.com)  
Configure a product to your exact needs and request a quotation.





**Overview****Flush design**

Indicator	4
Pushbutton	5
Illuminated pushbutton	7
Keylock switch	15
Selector switch	21

**Raised design**

Indicator	31
Illuminated pushbutton	33
Stop switch	37
Mushroom-head pushbutton	39
Keylock switch	41
Selector switch	47

**Accessories**

52

**Drawings**

76

**Technical data**

77

**Marking**

81

**Application guidelines**

83

**Index**

84

# 51 Flush design

## Indicator square, IP 65



Product can differ from the current configuration.



Dimensions [mm]  
 H = Universal terminal 2.0 x 0.5 mm,  
 L = Solder terminal,  
 L1 = Solder terminal 2.8 x 0.5 mm

### Additional Information

- For front dimension 24 x 24 mm



Mounting cut-outs [mm]

### Equipment consisting of (schematic overview)



Each Part Number listed below includes all the black components shown in the 3D-drawing.

*To obtain a complete unit, please select the red components from the pages shown.*

Terminal	Part No.	Component layout	Wiring diagram	Weight
 <b>Indicator actuator square, flush design</b>				
Solder 2.8 x 0.5 mm	<b>51-050.002F</b>		1	0.004 kg
Solder	<b>51-050.005F</b>		1	0.004 kg
Universal 2.0 x 0.5 mm	<b>51-051.006F</b>	4	1	0.005 kg

The component layouts you will find from page 76





## Indicator rectangular, IP 65

### Equipment consisting of (schematic overview)



**Lens** page 52



**Single-LED** page 71



**Actuator**



**Front bezel set** page 60



**Fixing nut**

Each Part Number listed below includes all the black components shown in the 3D-drawing.

To obtain a complete unit, please select the red components from the pages shown.



Dimensions [mm]  
 H = Universal terminal 2.0 x 0.5 mm,  
 L = Solder terminal,  
 L1 = Solder terminal 2.8 x 0.5 mm



Product can differ from the current configuration.



Mounting cut-outs [mm]

### Additional Information

- For front dimension 24 x 30 mm

Terminal	Part No.	Component layout	Wiring diagram	Weight
 <b>Indicator actuator rectangular</b>				
Solder 2.8 x 0.5 mm	<b>51-050.002F</b>		1	0.004 kg
Solder	<b>51-050.005F</b>		1	0.004 kg
Universal 2.0 x 0.5 mm	<b>51-051.006F</b>		4	0.005 kg

The component layouts you will find from page 76



# 51 Flush design

## Indicator round, IP 65



Product can differ from the current configuration.



Dimensions [mm]  
 H = Universal terminal 2.0 x 0.5 mm,  
 L = Solder terminal,  
 L1 = Solder terminal 2.8 x 0.5 mm

### Additional Information

- For front dimension  $\varnothing 25$  mm



Mounting cut-outs [mm]

### Equipment consisting of (schematic overview)



Each Part Number listed below includes all the black components shown in the 3D-drawing.

*To obtain a complete unit, please select the red components from the pages shown.*

Terminal	Part No.	Component layout	Wiring diagram	Weight
 <b>Indicator actuator round</b>				
Solder 2.8 x 0.5 mm	<b>51-050.002F</b>		1	0.004 kg
Solder	<b>51-050.005F</b>		1	0.004 kg
Universal 2.0 x 0.5 mm	<b>51-051.006F</b>	4	1	0.005 kg

The component layouts you will find from page 76



## Pushbutton round, IP 65

### Equipment consisting of (schematic overview)



Dimensions [mm]  
 H = Universal terminal 2.0 x 0.5 mm,  
 L = Solder terminal,  
 L1 = Solder terminal 2.8 x 0.5 mm



Product can differ from the current configuration.

### Additional Information

- For front dimension  $\varnothing 25$  mm

Each Part Number listed below includes all the black components shown in the 3D-drawing.

To obtain a complete unit, please select the red components from the pages shown.



Mounting cut-outs [mm]

Switching system	Contacts	Switching action	Terminal	Part No.	Component layout	Wiring diagram	Weight
 <b>Illuminated pushbutton actuator round</b>							
Low-level element	1 NC	B	Universal 2.0 x 0.5 mm	<b>51-456.036F</b>	1	1	0.006 kg
		C	Universal 2.0 x 0.5 mm	<b>51-486.036F</b>	1	2	0.006 kg
	1 NC + 1 NO	B	Universal 2.0 x 0.5 mm	<b>51-453.036F</b>	1	3	0.006 kg
		C	Universal 2.0 x 0.5 mm	<b>51-483.036F</b>	1	4	0.006 kg
	1 NO	B	Universal 2.0 x 0.5 mm	<b>51-455.036F</b>	1	5	0.006 kg
		C	Universal 2.0 x 0.5 mm	<b>51-485.036F</b>	1	6	0.006 kg
	2 NC	B	Universal 2.0 x 0.5 mm	<b>51-452.036F</b>	1	7	0.006 kg
		C	Universal 2.0 x 0.5 mm	<b>51-482.036F</b>	1	8	0.006 kg
	2 NO	B	Universal 2.0 x 0.5 mm	<b>51-451.036F</b>	1	9	0.006 kg
		C	Universal 2.0 x 0.5 mm	<b>51-481.036F</b>	1	10	0.006 kg
Snap-action switching element	1 NC + 1 NO	B	Solder 2.8 x 0.5 mm	<b>51-151.022F</b>		11	0.007 kg
		B	Solder	<b>51-151.0252F</b>		11	0.005 kg
	1 NC + 1 NO	C	Solder 2.8 x 0.5 mm	<b>51-281.022F</b>		12	0.007 kg
		C	Solder	<b>51-281.0252F</b>		12	0.005 kg
	2 NC + 2 NO	B	Solder	<b>51-152.0252F</b>		13	0.008 kg
		C	Solder	<b>51-282.0252F</b>		14	0.008 kg
	3 NC + 3 NO	B	Solder	<b>51-153.0252F</b>		15	0.010 kg
		C	Solder	<b>51-283.0252F</b>		16	0.010 kg
	4 NC + 4 NO	B	Solder	<b>51-154.0252F</b>		17	0.012 kg
		C	Solder	<b>51-284.0252F</b>		18	0.012 kg

Contacts: NC = Normally closed, NO = Normally open  
 Switching action: B = Momentary, C = Maintained  
 The component layouts you will find from page 76

# 51 Flush design



## Illuminated pushbutton square, IP 65

### Equipment consisting of (schematic overview)



**Lens** page 52



**Single-LED** page 71

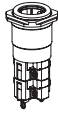

**Actuator**



**Front bezel set** page 60



**Fixing nut**

Each Part Number listed below includes all the black components shown in the 3D-drawing.

To obtain a complete unit, please select the red components from the pages shown.

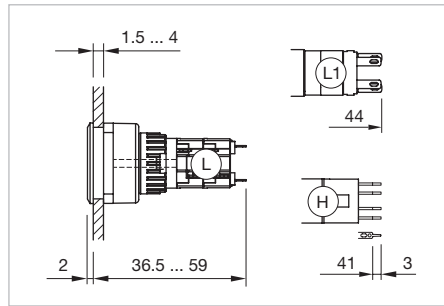

Dimensions [mm]  
 H = Universal terminal 2.0 x 0.5 mm,  
 L = Solder terminal,  
 L1 = Solder terminal 2.8 x 0.5 mm



Product can differ from the current configuration.

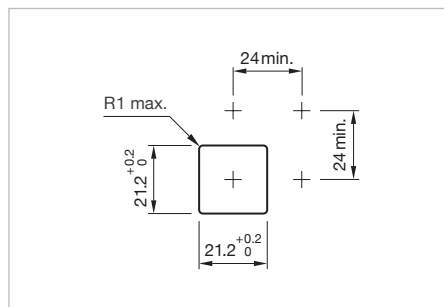

Mounting cut-outs [mm]

### Additional Information

- For front dimension 24 x 24 mm

Switching system	Contacts	Switching action	Terminal	Part No.	Component layout	Wiring diagram	Weight
 <b>Illuminated pushbutton square</b>							
Low-level element	1 NC	B	Universal 2.0 x 0.5 mm	<b>51-456.036F</b>	4	1	0.006 kg
		C	Universal 2.0 x 0.5 mm	<b>51-486.036F</b>	4	2	0.006 kg
	1 NC + 1 NO	B	Universal 2.0 x 0.5 mm	<b>51-453.036F</b>	4	3	0.006 kg
		C	Universal 2.0 x 0.5 mm	<b>51-483.036F</b>	4	4	0.006 kg
	1 NO	B	Universal 2.0 x 0.5 mm	<b>51-455.036F</b>	4	5	0.006 kg
		C	Universal 2.0 x 0.5 mm	<b>51-485.036F</b>	4	6	0.006 kg
	2 NC	B	Universal 2.0 x 0.5 mm	<b>51-452.036F</b>	4	7	0.006 kg
		C	Universal 2.0 x 0.5 mm	<b>51-482.036F</b>	4	8	0.006 kg
	2 NO	B	Universal 2.0 x 0.5 mm	<b>51-451.036F</b>	4	9	0.006 kg
		C	Universal 2.0 x 0.5 mm	<b>51-481.036F</b>	4	10	0.006 kg
Snap-action switching element	1 NC + 1 NO	B	Solder 2.8 x 0.5 mm	<b>51-151.022F</b>		11	0.007 kg
		B	Solder	<b>51-151.0252F</b>		12	0.005 kg
		C	Solder 2.8 x 0.5 mm	<b>51-281.022F</b>		13	0.007 kg
		C	Solder	<b>51-281.0252F</b>		14	0.005 kg
	2 NC + 2 NO	B	Solder	<b>51-152.0252F</b>		15	0.008 kg
		C	Solder	<b>51-282.0252F</b>		16	0.008 kg
	3 NC + 3 NO	B	Solder	<b>51-153.0252F</b>		17	0.010 kg
		C	Solder	<b>51-283.0252F</b>		18	0.010 kg
	4 NC + 4 NO	B	Solder	<b>51-154.0252F</b>		19	0.012 kg
		C	Solder	<b>51-284.0252F</b>		20	0.012 kg

Contacts: NC = Normally closed, NO = Normally open  
 Switching action: B = Momentary, C = Maintain  
 The component layouts you will find from page 76

# 51 Flush design



## Illuminated pushbutton rectangular, IP 65

### Equipment consisting of (schematic overview)



**Lens** page 52



**Single-LED** page 71



**Actuator**



**Front bezel set** page 60



**Fixing nut**

Each Part Number listed below includes all the black components shown in the 3D-drawing.

To obtain a complete unit, please select the red components from the pages shown.



Dimensions [mm]  
 H = Universal terminal 2.0 x 0.5 mm,  
 L = Solder terminal,  
 L1 = Solder terminal 2.8 x 0.5 mm



Product can differ from the current configuration.

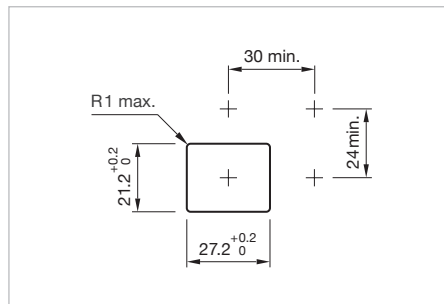

Mounting cut-outs [mm]

### Additional Information

- For front dimension 24 x 30 mm

Switching system	Contacts	Switching action	Terminal	Part No.	Component layout	Wiring diagram	Weight
 <b>Illuminated pushbutton actuator rectangular</b>							
Low-level element	1 NC	B	Universal 2.0 x 0.5 mm	<b>51-456.036F</b>	4	1	0.006 kg
		C	Universal 2.0 x 0.5 mm	<b>51-486.036F</b>	4	2	0.006 kg
	1 NC + 1 NO	B	Universal 2.0 x 0.5 mm	<b>51-453.036F</b>	4	3	0.006 kg
		C	Universal 2.0 x 0.5 mm	<b>51-483.036F</b>	4	4	0.006 kg
	1 NO	B	Universal 2.0 x 0.5 mm	<b>51-455.036F</b>	4	5	0.006 kg
		C	Universal 2.0 x 0.5 mm	<b>51-485.036F</b>	4	6	0.006 kg
	2 NC	B	Universal 2.0 x 0.5 mm	<b>51-452.036F</b>	4	7	0.006 kg
		C	Universal 2.0 x 0.5 mm	<b>51-482.036F</b>	4	8	0.006 kg
	2 NO	B	Universal 2.0 x 0.5 mm	<b>51-451.036F</b>	4	9	0.006 kg
		C	Universal 2.0 x 0.5 mm	<b>51-481.036F</b>	4	10	0.006 kg
Snap-action switching element	1 NC + 1 NO	B	Solder 2.8 x 0.5 mm	<b>51-151.022F</b>		11	0.007 kg
		B	Solder	<b>51-151.0252F</b>		12	0.005 kg
		C	Solder 2.8 x 0.5 mm	<b>51-281.022F</b>		13	0.007 kg
		C	Solder	<b>51-281.0252F</b>		14	0.005 kg
	2 NC + 2 NO	B	Solder	<b>51-152.0252F</b>		15	0.008 kg
		C	Solder	<b>51-282.0252F</b>		16	0.008 kg
	3 NC + 3 NO	B	Solder	<b>51-153.0252F</b>		17	0.010 kg
		C	Solder	<b>51-283.0252F</b>		18	0.010 kg
	4 NC + 4 NO	B	Solder	<b>51-154.0252F</b>		19	0.012 kg
		C	Solder	<b>51-284.0252F</b>		20	0.012 kg

Contacts: NC = Normally closed, NO = Normally open  
 Switching action: B = Momentary, C = Maintain  
 The component layouts you will find from page 76

# 51 Flush design





## Illuminated pushbutton round, IP 65

### Equipment consisting of (schematic overview)



Each Part Number listed below includes all the black components shown in the 3D-drawing.

To obtain a complete unit, please select the red components from the pages shown.

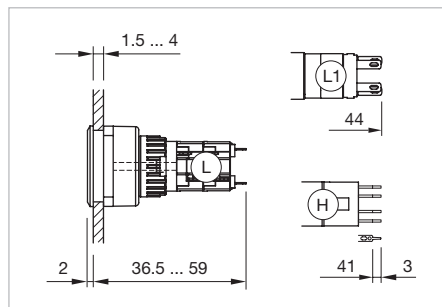

Dimensions [mm]  
 H = Universal terminal 2.0 x 0.5 mm,  
 L = Solder terminal,  
 L1 = Solder terminal 2.8 x 0.5 mm



Product can differ from the current configuration.

### Additional Information

- For front dimension  $\varnothing 25$  mm



Mounting cut-outs [mm]

Switching system	Contacts	Switching action	Terminal	Part No.	Component layout	Wiring diagram	Weight
 <b>Illuminated pushbutton round</b>							
Low-level element	1 NC	B	Universal 2.0 x 0.5 mm	<b>51-456.036F</b>	4	1	0.006 kg
		C	Universal 2.0 x 0.5 mm	<b>51-486.036F</b>	4	2	0.006 kg
	1 NC + 1 NO	B	Universal 2.0 x 0.5 mm	<b>51-453.036F</b>	4	3	0.006 kg
		C	Universal 2.0 x 0.5 mm	<b>51-483.036F</b>	4	4	0.006 kg
	1 NO	B	Universal 2.0 x 0.5 mm	<b>51-455.036F</b>	4	5	0.006 kg
		C	Universal 2.0 x 0.5 mm	<b>51-485.036F</b>	4	6	0.006 kg
	2 NC	B	Universal 2.0 x 0.5 mm	<b>51-452.036F</b>	4	7	0.006 kg
		C	Universal 2.0 x 0.5 mm	<b>51-482.036F</b>	4	8	0.006 kg
	2 NO	B	Universal 2.0 x 0.5 mm	<b>51-451.036F</b>	4	9	0.006 kg
		C	Universal 2.0 x 0.5 mm	<b>51-481.036F</b>	4	10	0.006 kg
Snap-action switching element	1 NC + 1 NO	B	Solder 2.8 x 0.5 mm	<b>51-151.022F</b>		11	0.007 kg
		B	Solder	<b>51-151.0252F</b>		12	0.005 kg
		C	Solder 2.8 x 0.5 mm	<b>51-281.022F</b>		13	0.007 kg
		C	Solder	<b>51-281.0252F</b>		14	0.005 kg
	2 NC + 2 NO	B	Solder	<b>51-152.0252F</b>		15	0.008 kg
		C	Solder	<b>51-282.0252F</b>		16	0.008 kg
	3 NC + 3 NO	B	Solder	<b>51-153.0252F</b>		17	0.010 kg
		C	Solder	<b>51-283.0252F</b>		18	0.010 kg
	4 NC + 4 NO	B	Solder	<b>51-154.0252F</b>		19	0.012 kg
		C	Solder	<b>51-284.0252F</b>		20	0.012 kg

Contacts: NC = Normally closed, NO = Normally open  
 Switching action: B = Momentary, C = Maintain  
 The component layouts you will find from page 76

# 51 Flush design



## Keylock switch 2 positions, IP 65

### Equipment consisting of (schematic overview)



Each Part Number listed below includes all the black components shown in the 3D-drawing.

To obtain a complete unit, please select the red components from the pages shown.



Dimensions [mm]  
 H = Universal terminal 2.0 x 0.5 mm,  
 L = Solder terminal,  
 L1 = Solder terminal 2.8 x 0.5 mm



Product can differ from the current configuration.



Mounting cut-outs [mm]

### Additional Information

- For front dimensions 24 x 24 mm, 24 x 30 mm, Ø 25 mm
- Front plastic black
- The standard lock: DOM 311
- Two keys are supplied with each key lock switch
- Optional lock numbers on request



Switching positions (A = Rest, B = Momentary, C = Maintained)

Switching system	Contacts	Switching action	Switching angle	Key remove	Terminal	Part No.	Component layout	Wiring diagram	Weight	
 <p><b>Keylock switch actuator 2 positions square, flush design</b></p>	1 NC + 1 NO	A - B	B = 42°	A	Universal 2.0 x 0.5 mm	<b>51-458.036DF</b>	4	1	0.027 kg	
	2 NO	A - B	B = 42°	A	Universal 2.0 x 0.5 mm	<b>51-457.036DF</b>	4	2	0.027 kg	
	1 NC + 1 NO	A - C	C = 90°	A	Universal 2.0 x 0.5 mm	<b>51-445.036DF</b>	4	7	0.027 kg	
				C	Universal 2.0 x 0.5 mm	<b>51-448.036DF</b>	4	7	0.027 kg	
				A + C	Universal 2.0 x 0.5 mm	<b>51-442.036DF</b>	4	7	0.027 kg	
	2 NO	A - C	C = 90°	A	Universal 2.0 x 0.5 mm	<b>51-444.036DF</b>	4	8	0.027 kg	
				C	Universal 2.0 x 0.5 mm	<b>51-447.036DF</b>	4	8	0.027 kg	
				A + C	Universal 2.0 x 0.5 mm	<b>51-441.036DF</b>	4	8	0.027 kg	
	Snap-action switching element	1 NC + 1 NO	A - B	B = 42°	A	Solder 2.8 x 0.5 mm	<b>51-145.022DF</b>		3	0.027 kg
					A	Solder	<b>51-145.025D2F</b>		3	0.027 kg
2 NC + 2 NO		A - B	B = 42°	A	Solder	<b>51-146.025D2F</b>		4	0.027 kg	
3 NC + 3 NO		A - B	B = 42°	A	Solder	<b>51-147.025D2F</b>		5	0.027 kg	
4 NC + 4 NO		A - B	B = 42°	A	Solder	<b>51-148.025D2F</b>		6	0.027 kg	
				A	Solder	<b>51-255.025D2F</b>		9	0.027 kg	
				C	Solder	<b>51-355.025D2F</b>		9	0.027 kg	
1 NC + 1 NO		A - C	C = 90°	A	Solder	<b>51-155.025D2F</b>		9	0.027 kg	
	A			Solder 2.8 x 0.5 mm	<b>51-255.022DF</b>		9	0.027 kg		

# 51 Flush design

Switching system	Contacts	Switching action	Switching angle	Key remove	Terminal	Part No.	Component layout	Wiring diagram	Weight
Snap-action switching element	1 NC + 1 NO	A - C	C = 90°	C	Solder 2.8 x 0.5 mm	<b>51-355.022DF</b>		9	0.027 kg
				A + C	Solder 2.8 x 0.5 mm	<b>51-155.022DF</b>		9	0.027 kg
	2 NC + 2 NO	A - C	C = 90°	A	Solder	<b>51-256.025D2F</b>		10	0.027 kg
				C	Solder	<b>51-356.025D2F</b>		10	0.027 kg
				A + C	Solder	<b>51-156.025D2F</b>		10	0.027 kg
				A	Solder	<b>51-257.025D2F</b>		11	0.027 kg
	3 NC + 3 NO	A - C	C = 90°	C	Solder	<b>51-357.025D2F</b>		11	0.027 kg
				A + C	Solder	<b>51-157.025D2F</b>		11	0.027 kg
				A	Solder	<b>51-258.025D2F</b>		12	0.027 kg
	4 NC + 4 NO	A - C	C = 90°	C	Solder	<b>51-358.025D2F</b>		12	0.027 kg
				A + C	Solder	<b>51-158.025D2F</b>		12	0.027 kg



## Keylock switch actuator 2 positions rectangular, flush design

Low-level element	1 NC + 1 NO	A - B	B = 42°	A	Universal 2.0 x 0.5 mm	<b>51-428.036DF</b>	4	1	0.029 kg
	2 NO	A - B	B = 42°	A	Universal 2.0 x 0.5 mm	<b>51-427.036DF</b>	4	2	0.029 kg
	1 NC + 1 NO	A - C	C = 90°	A	Universal 2.0 x 0.5 mm	<b>51-405.036DF</b>	4	7	0.029 kg
				C	Universal 2.0 x 0.5 mm	<b>51-408.036DF</b>	4	7	0.029 kg
				A + C	Universal 2.0 x 0.5 mm	<b>51-402.036DF</b>	4	7	0.029 kg
	2 NO	A - C	C = 90°	A	Universal 2.0 x 0.5 mm	<b>51-404.036DF</b>	4	8	0.029 kg
				C	Universal 2.0 x 0.5 mm	<b>51-407.036DF</b>	4	8	0.029 kg
				A + C	Universal 2.0 x 0.5 mm	<b>51-401.036DF</b>	4	8	0.029 kg
	Snap-action switching element	1 NC + 1 NO	A - B	B = 42°	A	Solder 2.8 x 0.5 mm	<b>51-495.022DF</b>		3
A					Solder	<b>51-495.025D2F</b>		3	0.029 kg
2 NC + 2 NO		A - B	B = 42°	A	Solder	<b>51-496.025D2F</b>		4	0.029 kg
3 NC + 3 NO		A - B	B = 42°	A	Solder	<b>51-497.025D2F</b>		5	0.029 kg
4 NC + 4 NO		A - B	B = 42°	A	Solder	<b>51-498.025D2F</b>		6	0.029 kg
1 NC + 1 NO		A - C	C = 90°	A	Solder	<b>51-295.025D2F</b>		9	0.029 kg
				C	Solder	<b>51-395.025D2F</b>		9	0.029 kg
				A + C	Solder	<b>51-195.025D2F</b>		9	0.029 kg
				A	Solder 2.8 x 0.5 mm	<b>51-295.022DF</b>		9	0.029 kg
				C	Solder 2.8 x 0.5 mm	<b>51-395.022DF</b>		9	0.029 kg
				A + C	Solder 2.8 x 0.5 mm	<b>51-195.022DF</b>		9	0.029 kg
2 NC + 2 NO		A - C	C = 90°	A	Solder	<b>51-296.025D2F</b>		10	0.029 kg
				C	Solder	<b>51-396.025D2F</b>		10	0.029 kg
				A + C	Solder	<b>51-196.025D2F</b>		10	0.029 kg
3 NC + 3 NO		A - C	C = 90°	A	Solder	<b>51-297.025D2F</b>		11	0.029 kg
				C	Solder	<b>51-397.025D2F</b>		11	0.029 kg
				A + C	Solder	<b>51-197.025D2F</b>		11	0.029 kg
4 NC + 4 NO		A - C	C = 90°	A	Solder	<b>51-298.025D2F</b>		12	0.029 kg
				C	Solder	<b>51-398.025D2F</b>		12	0.029 kg
				A + C	Solder	<b>51-198.025D2F</b>		12	0.029 kg

Switching system	Contacts	Switching action	Switching angle	Key remove	Terminal	Part No.	Component layout	Wiring diagram	Weight									
 <p><b>Keylock switch actuator 2 positions round, flush design</b></p>																		
Low-level element	1 NC + 1 NO	A - B	B = 42°	A	Universal 2.0 x 0.5 mm	<b>51-438.036DF</b>	4	1	0.026 kg									
	2 NO	A - B	B = 42°	A	Universal 2.0 x 0.5 mm	<b>51-437.036DF</b>	4	2	0.026 kg									
	1 NC + 1 NO	A - C	C = 90°	A	Universal 2.0 x 0.5 mm	<b>51-415.036DF</b>	4	7	0.026 kg									
				C	Universal 2.0 x 0.5 mm	<b>51-418.036DF</b>	4	7	0.026 kg									
				A + C	Universal 2.0 x 0.5 mm	<b>51-412.036DF</b>	4	7	0.026 kg									
	2 NO	A - C	C = 90°	A	Universal 2.0 x 0.5 mm	<b>51-414.036DF</b>	4	8	0.026 kg									
				C	Universal 2.0 x 0.5 mm	<b>51-417.036DF</b>	4	8	0.026 kg									
				A + C	Universal 2.0 x 0.5 mm	<b>51-411.036DF</b>	4	8	0.026 kg									
	Snap-action switching element	1 NC + 1 NO	A - B	B = 42°	A	Solder 2.8 x 0.5 mm	<b>51-141.022DF</b>		3	0.026 kg								
A					Solder	<b>51-141.025D2F</b>		3	0.026 kg									
2 NC + 2 NO		A - B	B = 42°	A	Solder	<b>51-142.025D2F</b>		4	0.026 kg									
3 NC + 3 NO		A - B	B = 42°	A	Solder	<b>51-143.025D2F</b>		5	0.026 kg									
4 NC + 4 NO		A - B	B = 42°	A	Solder	<b>51-144.025D2F</b>		6	0.026 kg									
										1 NC + 1 NO	A - C	C = 90°	A	Solder	<b>51-235.025D2F</b>		9	0.026 kg
													C	Solder	<b>51-335.025D2F</b>		9	0.026 kg
													A + C	Solder	<b>51-135.025D2F</b>		9	0.026 kg
										A	Solder 2.8 x 0.5 mm	<b>51-235.022DF</b>		9	0.026 kg			
																C	Solder 2.8 x 0.5 mm	<b>51-335.022DF</b>
A + C		Solder 2.8 x 0.5 mm	<b>51-135.022DF</b>		9	0.026 kg												
2 NC + 2 NO		A - C	C = 90°	A	Solder	<b>51-236.025D2F</b>		10	0.026 kg									
				C	Solder	<b>51-336.025D2F</b>		10	0.026 kg									
				A + C	Solder	<b>51-136.025D2F</b>		10	0.026 kg									
3 NC + 3 NO		A - C	C = 90°	A	Solder	<b>51-237.025D2F</b>		11	0.026 kg									
				C	Solder	<b>51-337.025D2F</b>		11	0.026 kg									
				A + C	Solder	<b>51-137.025D2F</b>		11	0.026 kg									
4 NC + 4 NO		A - C	C = 90°	A	Solder	<b>51-238.025D2F</b>		12	0.026 kg									
				C	Solder	<b>51-338.025D2F</b>		12	0.026 kg									
				A + C	Solder	<b>51-138.025D2F</b>		12	0.026 kg									

Contacts: NC = Normally closed, NO = Normally open  
 Switching action: A = Rest, B = Momentary, C = Maintain  
 The component layouts you will find from page 76

# 51 Flush design

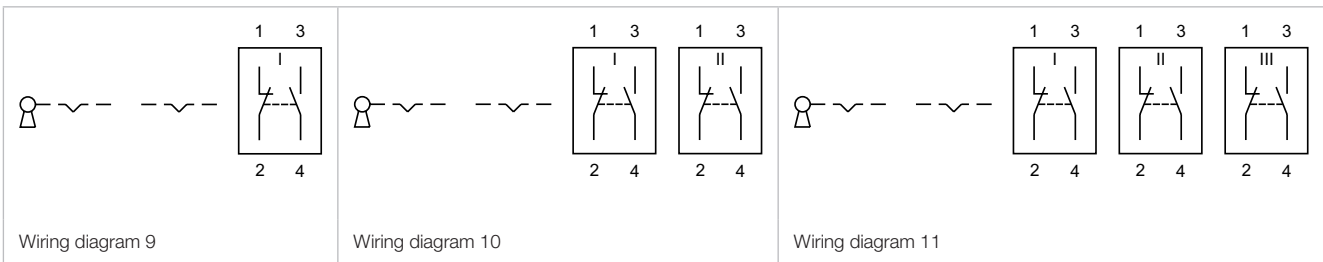
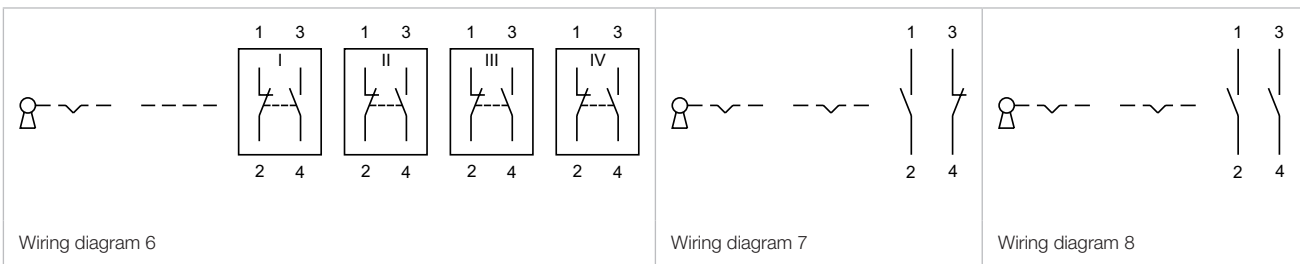
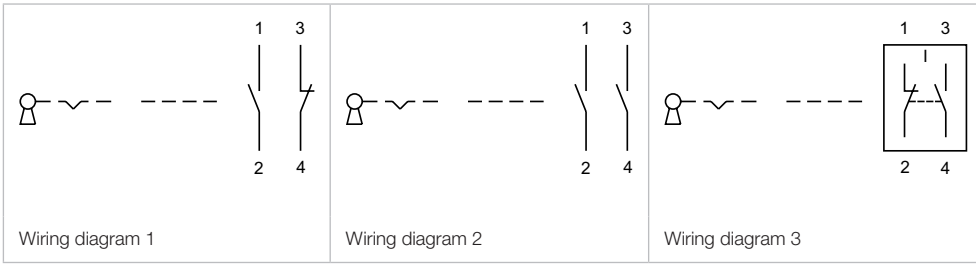

## Keylock switch 3 positions, IP 65

### Equipment consisting of (schematic overview)



Each Part Number listed below includes all the black components shown in the 3D-drawing.

To obtain a complete unit, please select the red components from the page s shown.



Dimensions [mm]



Mounting cut-outs [mm]



Product can differ from the current configuration.

### Additional Information

- For front dimensions 24 x 24 mm, 24 x 30 mm, Ø 25 mm
- Front plastic black
- The standard lock: DOM 311
- Two keys are supplied with each key lock switch
- Optional lock numbers on request



Switching positions (A = Rest, B = Momentary, C = Maintained)

Switching system	Contacts	Switching action	Switching angle	Key remove	Terminal	Part No.	Wiring diagram	Weight
 <p><b>Keylock switch actuator 3 positions square, flush design</b></p>	2 NC + 2 NO	B - A - B	B = 42° / 42°	A	Solder 2.8 x 0.5 mm	<b>51-384.022DF</b>	1	0.027 kg
		C - A - B	C = 90°, B = 42°	A	Solder 2.8 x 0.5 mm	<b>51-387.022DF</b>	2	0.027 kg
				C + A	Solder 2.8 x 0.5 mm	<b>51-388.022DF</b>	2	0.027 kg
		B - A - C	B = 42°, C = 90°	A	Solder 2.8 x 0.5 mm	<b>51-385.022DF</b>	3	0.027 kg
				A + C	Solder 2.8 x 0.5 mm	<b>51-386.022DF</b>	3	0.027 kg
		C - A - C	C = 90° / 90°	A	Solder 2.8 x 0.5 mm	<b>51-381.022DF</b>	4	0.027 kg
				C + A + C	Solder 2.8 x 0.5 mm	<b>51-382.022DF</b>	4	0.027 kg
				C + C	Solder 2.8 x 0.5 mm	<b>51-383.022DF</b>	4	0.027 kg

# 51 Flush design

Switching system	Contacts	Switching action	Switching angle	Key remove	Terminal	Part No.	Wiring diagram	Weight
------------------	----------	------------------	-----------------	------------	----------	----------	----------------	--------



### Keylock switch actuator 3 positions rectangular, flush design

Snap-action switching element	2 NC + 2 NO	B - A - B	B = 42° / 42°	A	Solder 2.8 x 0.5 mm	<b>51-364.022DF</b>	1	0.027 kg
		C - A - B	C = 90°, B = 42°	A	Solder 2.8 x 0.5 mm	<b>51-367.022DF</b>	2	0.027 kg
				C + A	Solder 2.8 x 0.5 mm	<b>51-368.022DF</b>	2	0.027 kg
		B - A - C	B = 42°, C = 90°	A	Solder 2.8 x 0.5 mm	<b>51-365.022DF</b>	3	0.027 kg
				A + C	Solder 2.8 x 0.5 mm	<b>51-366.022DF</b>	3	0.027 kg
		C - A - C	C = 90° / 90°	A	Solder 2.8 x 0.5 mm	<b>51-361.022DF</b>	4	0.027 kg
				C + A + C	Solder 2.8 x 0.5 mm	<b>51-362.022DF</b>	4	0.027 kg
		C + C	Solder 2.8 x 0.5 mm	<b>51-363.022DF</b>	4	0.027 kg		



### Keylock switch actuator 3 positions round, flush design

Snap-action switching element	2 NC + 2 NO	B - A - B	B = 42° / 42°	A	Solder 2.8 x 0.5 mm	<b>51-374.022DF</b>	1	0.027 kg
		C - A - B	C = 90°, B = 42°	A	Solder 2.8 x 0.5 mm	<b>51-377.022DF</b>	2	0.027 kg
				C + A	Solder 2.8 x 0.5 mm	<b>51-378.022DF</b>	2	0.027 kg
		B - A - C	B = 42°, C = 90°	A	Solder 2.8 x 0.5 mm	<b>51-375.022DF</b>	3	0.027 kg
				A + C	Solder 2.8 x 0.5 mm	<b>51-376.022DF</b>	3	0.027 kg
		C - A - C	C = 90° / 90°	A	Solder 2.8 x 0.5 mm	<b>51-371.022DF</b>	4	0.027 kg
				C + A + C	Solder 2.8 x 0.5 mm	<b>51-372.022DF</b>	4	0.027 kg
		C + C	Solder 2.8 x 0.5 mm	<b>51-373.022DF</b>	4	0.027 kg		

Contacts: NC = Normally closed, NO = Normally open  
Switching action: A = Rest, B = Momentary, C = Maintain





## Selector switch 2 positions square, IP 65

### Equipment consisting of (schematic overview)



Each Part Number listed below includes all the black components shown in the 3D-drawing.

To obtain a complete unit, please select the red components from the pages shown.



Dimensions [mm]  
 H = Universal terminal 2.0 x 0.5 mm,  
 L = Solder terminal,  
 L1 = Solder terminal 2.8 x 0.5 mm



Product can differ from the current configuration.



Mounting cut-outs [mm]

### Additional Information

- For front dimension 24 x 24 mm
- Illuminative



Switching positions (A = Rest, B = Momentary, C = Maintained)

Switching system	Contacts	Switching action	Switching angle	Terminal	Part No.	Component layout	Wiring diagram	Weight
 <h3>Selector switch actuator 2 positions square, flush design</h3>								
Low-level element	1 NC	A - B	B = 42°	Universal 2.0 x 0.5 mm	<b>52-436.036</b>	4	1	0.007 kg
	1 NC + 1 NO	A - B	B = 42°	Universal 2.0 x 0.5 mm	<b>52-433.036</b>	4	2	0.007 kg
	1 NO	A - B	B = 42°	Universal 2.0 x 0.5 mm	<b>52-435.036</b>	4	3	0.007 kg
	2 NC	A - B	B = 42°	Universal 2.0 x 0.5 mm	<b>52-432.036</b>	4	4	0.007 kg
	2 NO	A - B	B = 42°	Universal 2.0 x 0.5 mm	<b>52-431.036</b>	4	5	0.007 kg
	1 NC	A - C	C = 90°	Universal 2.0 x 0.5 mm	<b>52-476.036</b>	4	11	0.007 kg
	1 NC + 1 NO	A - C	C = 90°	Universal 2.0 x 0.5 mm	<b>52-473.036</b>	4	12	0.007 kg
	1 NO	A - C	C = 90°	Universal 2.0 x 0.5 mm	<b>52-475.036</b>	4	13	0.007 kg
	2 NC	A - C	C = 90°	Universal 2.0 x 0.5 mm	<b>52-472.036</b>	4	14	0.007 kg
	2 NO	A - C	C = 90°	Universal 2.0 x 0.5 mm	<b>52-471.036</b>	4	15	0.007 kg
Snap-action switching element	1 NC + 1 NO	A - B	B = 42°	Solder	<b>52-131.0252</b>	6	0.006 kg	
				Solder 2.8 x 0.5 mm	<b>52-131.022</b>	7	0.006 kg	
	2 NC + 2 NO	A - B	B = 42°	Solder	<b>52-132.0252</b>	8	0.006 kg	
	3 NC + 3 NO	A - B	B = 42°	Solder	<b>52-133.0252</b>	9	0.006 kg	
	4 NC + 4 NO	A - B	B = 42°	Solder	<b>52-134.0252</b>	10	0.006 kg	
	1 NC + 1 NO	A - C	C = 90°	Solder	<b>52-271.0252</b>	16	0.006 kg	
Solder 2.8 x 0.5 mm				<b>52-271.022</b>	17	0.006 kg		

# 51 Flush design

Switching system	Contacts	Switching action	Switching angle	Terminal	Part No.	Component layout	Wiring diagram	Weight
Snap-action switching element	2 NC + 2 NO	A - C	C = 90°	Solder	<b>52-272.0252</b>		18	0.006 kg
	3 NC + 3 NO	A - C	C = 90°	Solder	<b>52-273.0252</b>		19	0.006 kg
	4 NC + 4 NO	A - C	C = 90°	Solder	<b>52-274.0252</b>		20	0.006 kg

Contacts: NC = Normally closed, NO = Normally open  
 Switching action: A = Rest, B = Momentary, C = Maintain  
 The component layouts you will find from page 76

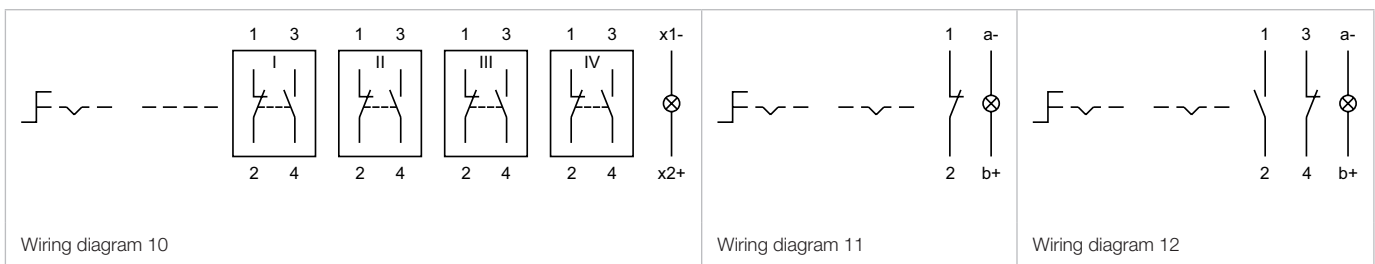



# 51 Flush design

## Selector switch 2 positions round, IP 65



Product can differ from the current configuration.



Dimensions [mm]  
 H = Universal terminal 2.0 x 0.5 mm,  
 L = Solder terminal,  
 L1 = Solder terminal 2.8 x 0.5 mm

### Additional Information

- For front dimension Ø 25 mm
- Illuminative



Mounting cut-outs [mm]

### Equipment consisting of (schematic overview)

- Lever** page 58
- Single-LED** page 71
- Actuator**
- Front bezel set** page 63
- Anti-twist ring**
- Part of front bezel set**
- Fixing nut**

Each Part Number listed below includes all the black components shown in the 3D-drawing.

*To obtain a complete unit, please select the red components from the pages shown.*



Switching positions (A = Rest, B = Momentary, C = Maintained)

Switching system	Contacts	Switching action	Switching angle	Terminal	Part No.	Component layout	Wiring diagram	Weight
<b>Selector switch actuator 2 positions round, flush design</b>								
Low-level element	1 NC	A - B	B = 42°	Universal 2.0 x 0.5 mm	<b>52-436.036</b>	4	1	0.007 kg
	1 NC + 1 NO	A - B	B = 42°	Universal 2.0 x 0.5 mm	<b>52-433.036</b>	4	2	0.007 kg
	1 NO	A - B	B = 42°	Universal 2.0 x 0.5 mm	<b>52-435.036</b>	4	3	0.007 kg
	2 NC	A - B	B = 42°	Universal 2.0 x 0.5 mm	<b>52-432.036</b>	4	4	0.007 kg
	2 NO	A - B	B = 42°	Universal 2.0 x 0.5 mm	<b>52-431.036</b>	4	5	0.007 kg
	1 NC	A - C	C = 90°	Universal 2.0 x 0.5 mm	<b>52-476.036</b>	4	11	0.007 kg
	1 NC + 1 NO	A - C	C = 90°	Universal 2.0 x 0.5 mm	<b>52-473.036</b>	4	12	0.007 kg
	1 NO	A - C	C = 90°	Universal 2.0 x 0.5 mm	<b>52-475.036</b>	4	13	0.007 kg
	2 NC	A - C	C = 90°	Universal 2.0 x 0.5 mm	<b>52-472.036</b>	4	14	0.007 kg
	2 NO	A - C	C = 90°	Universal 2.0 x 0.5 mm	<b>52-471.036</b>	4	15	0.007 kg
Snap-action switching element	1 NC + 1 NO	A - B	B = 42°	Solder	<b>52-131.0252</b>	6	1	0.006 kg
				Solder 2.8 x 0.5 mm	<b>52-131.022</b>			
	2 NC + 2 NO	A - B	B = 42°	Solder	<b>52-132.0252</b>	8	0.006 kg	
	3 NC + 3 NO	A - B	B = 42°	Solder	<b>52-133.0252</b>	9	0.006 kg	
	4 NC + 4 NO	A - B	B = 42°	Solder	<b>52-134.0252</b>	10	0.006 kg	
	1 NC + 1 NO	A - C	C = 90°	Solder	<b>52-271.0252</b>	16	1	0.006 kg
				Solder 2.8 x 0.5 mm	<b>52-271.022</b>			

Switching system	Contacts	Switching action	Switching angle	Terminal	Part No.	Component layout	Wiring diagram	Weight
Snap-action switching element	2 NC + 2 NO	A - C	C = 90°	Solder	<b>52-272.0252</b>		18	0.006 kg
	3 NC + 3 NO	A - C	C = 90°	Solder	<b>52-273.0252</b>		19	0.006 kg
	4 NC + 4 NO	A - C	C = 90°	Solder	<b>52-274.0252</b>		20	0.006 kg

Contacts: NC = Normally closed, NO = Normally open  
 Switching action: A = Rest, B = Momentary, C = Maintain  
 The component layouts you will find from page 76

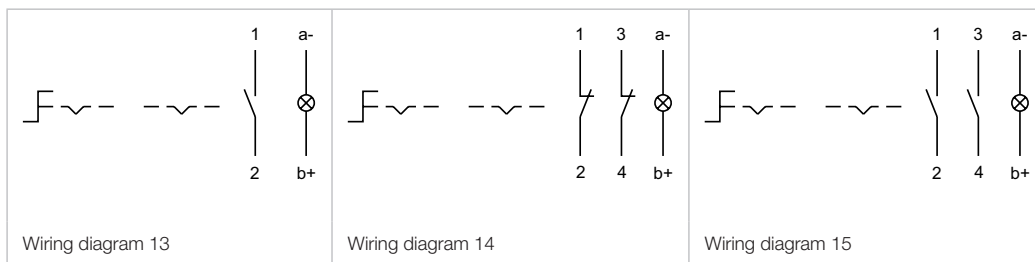

# 51 Flush design



## Selector switch 3 positions square, IP 40

### Equipment consisting of (schematic overview)



Each Part Number listed below includes all the black components shown in the 3D-drawing.

To obtain a complete unit, please select the red components from the pages shown.



Dimensions [mm]



Mounting cut-outs [mm]



Product can differ from the current configuration.

### Additional Information

- For front dimension 24 x 24 mm
- Illuminative

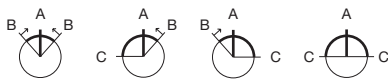

Switching positions (A = Rest, B = Momentary, C = Maintained)

Switching system	Contacts	Switching action	Switching angle	Terminal	Part No.	Wiring diagram	Weight
<b>Selector switch actuator 3 positions square, flush design</b>	2 NC + 2 NO	B - A - B	B = 42° / 42°	Solder 2.8 x 0.5 mm	<b>52-572.022A</b>	1	0.015 kg
		C - A - B	C = 90°, B = 42°	Solder 2.8 x 0.5 mm	<b>52-574.022A</b>	2	0.015 kg
		B - A - C	B = 42°, C = 90°	Solder 2.8 x 0.5 mm	<b>52-573.022A</b>	3	0.015 kg
		C - A - C	C = 90° / 90°	Solder 2.8 x 0.5 mm	<b>52-571.022A</b>	4	0.015 kg

Contacts: NC = Normally closed, NO = Normally open  
 Switching action: A = Rest, B = Momentary, C = Maintain

# 51 Flush design





## Selector switch 3 positions round, IP 40

### Equipment consisting of (schematic overview)



Dimensions [mm]



Product can differ from the current configuration.



Mounting cut-outs [mm]

### Additional Information

- For front dimension  $\varnothing 25$  mm
- Illuminative

Each Part Number listed below includes all the black components shown in the 3D-drawing.

To obtain a complete unit, please select the red components from the pages shown.



Switching positions (A = Rest, B = Momentary, C = Maintained)

Switching system	Contacts	Switching action	Switching angle	Terminal	Part No.	Wiring diagram	Weight
 <b>Selector switch actuator 3 positions round, flush design</b>	2 NC + 2 NO	B - A - B	B = 42° / 42°	Solder 2.8 x 0.5 mm	<b>52-572.022A</b>	1	0.015 kg
		C - A - B	C = 90°, B = 42°	Solder 2.8 x 0.5 mm	<b>52-574.022A</b>	2	0.015 kg
		B - A - C	B = 42°, C = 90°	Solder 2.8 x 0.5 mm	<b>52-573.022A</b>	3	0.015 kg
		C - A - C	C = 90° / 90°	Solder 2.8 x 0.5 mm	<b>52-571.022A</b>	4	0.015 kg

Contacts: NC = Normally closed, NO = Normally open  
Switching action: A = Rest, B = Momentary, C = Maintain

# 51 Flush design

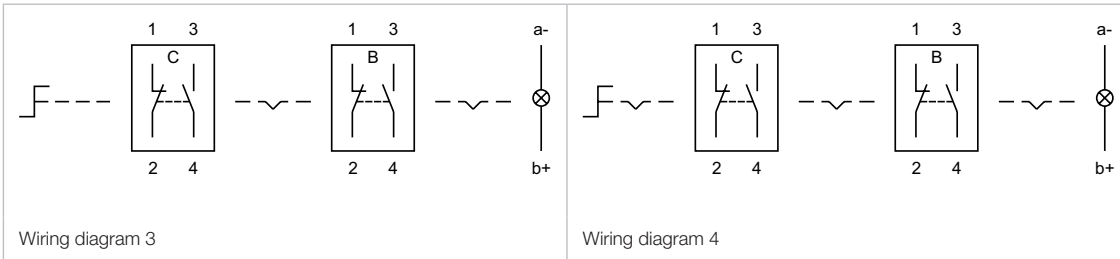
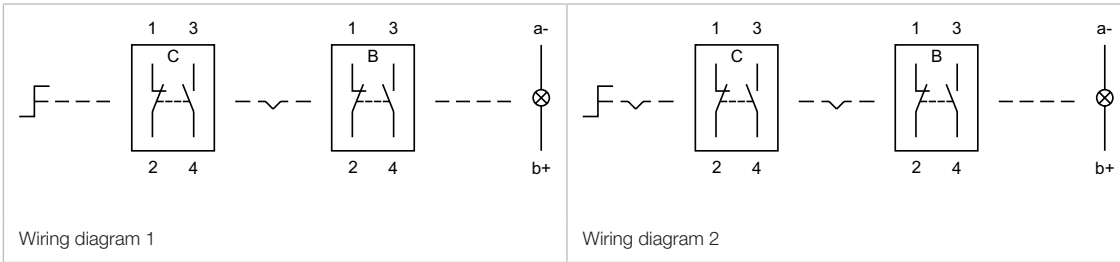

Indicator, IP 65

Equipment consisting of (schematic overview)



Dimensions [mm]  
 H = Universal terminal 2.0 x 0.5 mm,  
 L = Solder terminal,  
 L1 = Solder terminal 2.8 x 0.5 mm



Product can differ from the current configuration.

Each Part Number listed below includes all the black components shown in the 3D-drawing.

To obtain a complete unit, please select the red components from the pages shown.



Mounting cut-outs [mm]

		Terminal	Part No.	Component layout	Wiring diagram	Weight
		<b>Indicator actuator, Front dimension 18 x 18 mm</b>				
1		Universal 2.0 x 0.5 mm	<b>51-703.006</b>	4	3	0.006 kg
2		Universal 2.0 x 0.5 mm	<b>51-704.006</b>	4	2	0.006 kg
		Solder 2.8 x 0.5 mm	<b>51-050.002</b>		1	0.004 kg
		Solder	<b>51-050.005</b>		1	0.004 kg
		Universal 2.0 x 0.5 mm	<b>51-051.006</b>	4	1	0.005 kg
		<b>Indicator actuator, Front dimension 18 x 24 mm</b>				
1		Universal 2.0 x 0.5 mm	<b>51-701.006</b>	4	3	0.006 kg
2		Universal 2.0 x 0.5 mm	<b>51-702.006</b>	4	2	0.006 kg
		Solder 2.8 x 0.5 mm	<b>51-040.002</b>		1	0.004 kg
		Solder	<b>51-040.005</b>		1	0.004 kg
		Universal 2.0 x 0.5 mm	<b>51-041.006</b>	4	1	0.005 kg

# 51 Raised design

Diode 1N4007	Terminal	Part No.	Component layout	Wiring diagram	Weight
 <p><b>Indicator actuator, Front dimension Ø 18 mm</b></p>					
1	Universal 2.0 x 0.5 mm	<b>51-741.006</b>	4	3	0.006 kg
2	Universal 2.0 x 0.5 mm	<b>51-742.006</b>	4	2	0.006 kg
	Solder 2.8 x 0.5 mm	<b>51-030.002</b>		1	0.004 kg
	Solder	<b>51-030.005</b>		1	0.004 kg
	Universal 2.0 x 0.5 mm	<b>51-031.006</b>	4	1	0.005 kg

The component layouts you will find from page 76



**Illuminated pushbutton, IP 65**



Dimensions [mm]  
 H = Universal terminal 2.0 x 0.5 mm,  
 H1 = Universal-Solder terminal,  
 L = Solder terminal,  
 L1 = Solder terminal 2.8 x 0.5 mm

Product can differ from the current configuration.

Each Part Number listed below includes all the black components shown in the 3D-drawing.

To obtain a complete unit, please select the red components from the pages shown.



Mounting cut-outs [mm]

Switching system	Contacts	Diode 1N4007	Switching action	Terminal	Part No.	Component layout	Wiring diagram	Weight
 <p><b>Illuminated pushbutton actuator, Front dimension 18 x 18 mm</b></p>								
Low-level element	1 NC		C	Universal 2.0 x 0.5 mm	<b>51-486.036</b>	4	2	0.007 kg
	1 NC + 1 NO		B	Universal 2.0 x 0.5 mm	<b>51-453.036</b>	4	3	0.007 kg
			C	Universal 2.0 x 0.5 mm	<b>51-483.036</b>	4	4	0.007 kg
	1 NO		B	Universal 2.0 x 0.5 mm	<b>51-455.036</b>	4	5	0.007 kg
			C	Universal 2.0 x 0.5 mm	<b>51-485.036</b>	4	6	0.007 kg
	2 NC		B	Universal 2.0 x 0.5 mm	<b>51-452.036</b>	4	7	0.007 kg
2 NO		B	Universal 2.0 x 0.5 mm	<b>51-451.036</b>	4	9	0.007 kg	
		C	Universal 2.0 x 0.5 mm	<b>51-481.036</b>	4	10	0.007 kg	
Snap-action switching element	1 NC + 1 NO	2	C	Universal-Solder	<b>51-718.0292</b>		13	0.008 kg
			B	Universal-Solder	<b>51-710.0292</b>		14	0.008 kg
			B	Solder	<b>51-151.0252</b>		15	0.006 kg
			B	Solder 2.8 x 0.5 mm	<b>51-151.022</b>		16	0.006 kg
			C	Solder	<b>51-281.0252</b>		17	0.006 kg
			C	Solder 2.8 x 0.5 mm	<b>51-281.022</b>		18	0.006 kg
	2 NC + 2 NO	1	C	Universal-Solder	<b>51-719.0292</b>		20	0.010 kg
		2	B	Universal-Solder	<b>51-712.0292</b>		21	0.010 kg
			C	Universal-Solder	<b>51-720.0292</b>		22	0.010 kg
		B	Solder	<b>51-152.0252</b>		23	0.008 kg	
		C	Solder	<b>51-282.0252</b>		24	0.008 kg	

# 51 Raised design

Switching system	Contacts	Diode 1N4007	Switching action	Terminal	Part No.	Component layout	Wiring diagram	Weight
Snap-action switching element	3 NC + 3 NO		B	Solder	<b>51-153.0252</b>		25	0.010 kg
			C	Solder	<b>51-283.0252</b>		26	0.010 kg
	4 NC + 4 NO		B	Solder	<b>51-154.0252</b>		27	0.012 kg
			C	Solder	<b>51-284.0252</b>		28	0.012 kg



## Illuminated pushbutton actuator, Front dimension 18 x 24 mm

Low-level element	1 NC		B	Universal 2.0 x 0.5 mm	<b>51-426.036</b>	4	1	0.007 kg
	1 NC + 1 NO		B	Universal 2.0 x 0.5 mm	<b>51-423.036</b>	4	3	0.007 kg
			C	Universal 2.0 x 0.5 mm	<b>51-463.036</b>	4	4	0.007 kg
	1 NO		B	Universal 2.0 x 0.5 mm	<b>51-425.036</b>	4	5	0.007 kg
			C	Universal 2.0 x 0.5 mm	<b>51-465.036</b>	4	6	0.007 kg
	2 NC		B	Universal 2.0 x 0.5 mm	<b>51-422.036</b>	4	7	0.007 kg
	2 NO		B	Universal 2.0 x 0.5 mm	<b>51-421.036</b>	4	9	0.007 kg
			C	Universal 2.0 x 0.5 mm	<b>51-461.036</b>	4	10	0.007 kg
Snap-action switching element	1 NC + 1 NO	1	B	Universal-Solder	<b>51-705.0292</b>		11	0.008 kg
			C	Universal-Solder	<b>51-714.0292</b>		13	0.008 kg
			B	Universal-Solder	<b>51-706.0292</b>		14	0.008 kg
			B	Solder	<b>51-121.0252</b>		15	0.006 kg
			B	Solder 2.8 x 0.5 mm	<b>51-121.022</b>		16	0.006 kg
			C	Solder	<b>51-261.0252</b>		17	0.006 kg
	2 NC + 2 NO	1	B	Universal-Solder	<b>51-707.0292</b>		19	0.010 kg
			C	Universal-Solder	<b>51-715.0292</b>		20	0.010 kg
		2	B	Universal-Solder	<b>51-708.0292</b>		21	0.010 kg
			C	Universal-Solder	<b>51-716.0292</b>		22	0.010 kg
			B	Solder	<b>51-122.0252</b>		23	0.008 kg
			C	Solder	<b>51-262.0252</b>		24	0.008 kg
	3 NC + 3 NO		B	Solder	<b>51-123.0252</b>		25	0.010 kg
			C	Solder	<b>51-263.0252</b>		26	0.010 kg
	4 NC + 4 NO		B	Solder	<b>51-124.0252</b>		27	0.012 kg
			C	Solder	<b>51-264.0252</b>		28	0.012 kg



## Illuminated pushbutton actuator, Front dimension Ø 18 mm

Low-level element	1 NC		B	Universal 2.0 x 0.5 mm	<b>51-436.036</b>	4	1	0.007 kg
	1 NC + 1 NO		B	Universal 2.0 x 0.5 mm	<b>51-433.036</b>	4	3	0.007 kg
			C	Universal 2.0 x 0.5 mm	<b>51-473.036</b>	4	4	0.007 kg
	1 NO		B	Universal 2.0 x 0.5 mm	<b>51-435.036</b>	4	5	0.007 kg
			C	Universal 2.0 x 0.5 mm	<b>51-475.036</b>	4	6	0.007 kg
	2 NO		B	Universal 2.0 x 0.5 mm	<b>51-431.036</b>	4	9	0.007 kg
			C	Universal 2.0 x 0.5 mm	<b>51-471.036</b>	4	10	0.007 kg
	Snap-action switching element		1 NC + 1 NO	1	C	Universal-Solder	<b>51-747.0292</b>	
B		Solder			<b>51-131.0252</b>		15	0.006 kg
		B		Solder 2.8 x 0.5 mm	<b>51-131.022</b>		16	0.006 kg
		C		Solder	<b>51-271.0252</b>		17	0.006 kg
		C		Solder 2.8 x 0.5 mm	<b>51-271.022</b>		18	0.006 kg
		2 NC + 2 NO		1	C	Universal-Solder	<b>51-749.0292</b>	
B			Universal-Solder		<b>51-746.0292</b>		21	0.010 kg
2			C	Universal-Solder	<b>51-750.0292</b>		22	0.010 kg

Switching system	Contacts	Diode 1N4007	Switching action	Terminal	Part No.	Component layout	Wiring diagram	Weight
Snap-action switching element	2 NC + 2 NO		B	Solder	<b>51-132.0252</b>		23	0.008 kg
			C	Solder	<b>51-272.0252</b>		24	0.008 kg
	3 NC + 3 NO		B	Solder	<b>51-133.0252</b>		25	0.010 kg
			C	Solder	<b>51-273.0252</b>		26	0.010 kg
	4 NC + 4 NO		B	Solder	<b>51-134.0252</b>		27	0.012 kg
			C	Solder	<b>51-274.0252</b>		28	0.012 kg

Contacts: NC = Normally closed, NO = Normally open  
 Switching action: B = Momentary, C = Maintain  
 The component layouts you will find from page 76



# 51 Raised design

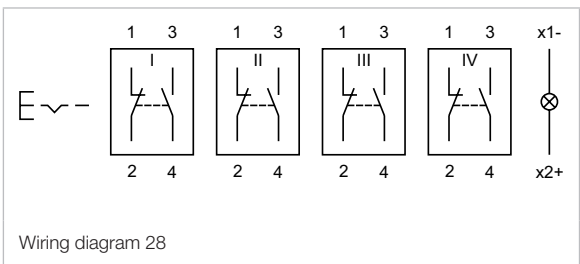
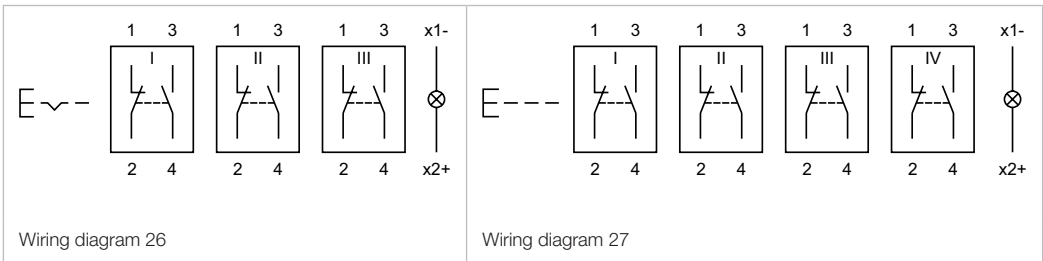
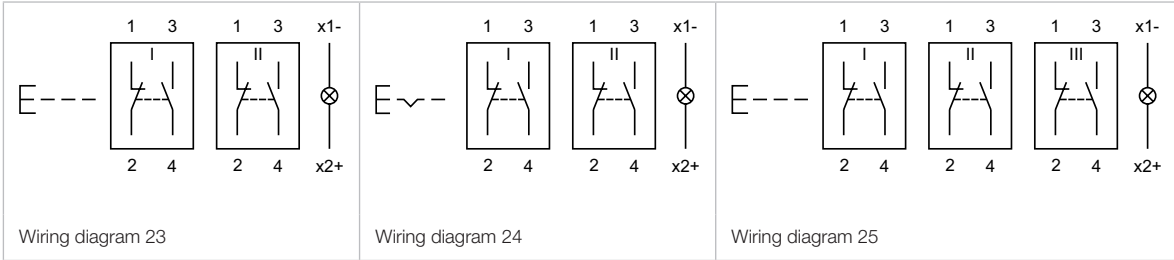



## Stop switch complete, IP 65

### Equipment consisting of (schematic overview)



Product can differ from the current configuration.

Each Part Number listed below includes all the black components shown in the 3D-drawing.

Dimensions [mm]  
 H = Universal terminal 2.0 x 0.5 mm,  
 L = Solder terminal,  
 L1 = Solder terminal 2.8 x 0.5 mm



Mounting cut-outs [mm]

### Additional Information

- Marking arrows
- If the anti-twist ring is not used the panel thickness increases to 4 mm

Lens	Switching system	Contacts	Switching action	Terminal	Part No.	Wiring diagram	Weight
 <b>Stop switch complete round, 24.5 mm</b>	Low-level element	1 NC	C	Universal 2.0 x 0.5 mm	<b>51-256.026</b>	3	0.010 kg
		1 NC + 1 NO	C	Universal 2.0 x 0.5 mm	<b>51-253.026</b>	5	0.011 kg
		2 NC	C	Universal 2.0 x 0.5 mm	<b>51-252.026</b>	4	0.011 kg
	Snap-action switching element	1 NC + 1 NO	C	Solder 2.8 x 0.5 mm	<b>51-253.022</b>	1	0.011 kg
		1 NC + 1 NO	C	Solder	<b>51-256.025</b>	1	0.011 kg
		2 NC + 2 NO	C	Solder	<b>51-259.025</b>	2	0.011 kg
Plastic yellow	Low-level element	1 NC	C	Universal 2.0 x 0.5 mm	<b>51-256.0264</b>	3	0.010 kg
		1 NC + 1 NO	C	Universal 2.0 x 0.5 mm	<b>51-253.0264</b>	5	0.011 kg
		2 NC	C	Universal 2.0 x 0.5 mm	<b>51-252.0264</b>	4	0.011 kg
	Snap-action switching element	1 NC + 1 NO	C	Solder 2.8 x 0.5 mm	<b>51-253.0224</b>	1	0.011 kg
		1 NC + 1 NO	C	Solder	<b>51-256.0254</b>	1	0.011 kg
		2 NC + 2 NO	C	Solder	<b>51-259.0254</b>	2	0.011 kg
Plastic green	Low-level element	1 NC	C	Universal 2.0 x 0.5 mm	<b>51-256.0265</b>	3	0.010 kg
		1 NC + 1 NO	C	Universal 2.0 x 0.5 mm	<b>51-253.0265</b>	5	0.011 kg
		2 NC	C	Universal 2.0 x 0.5 mm	<b>51-252.0265</b>	4	0.011 kg
	Snap-action switching element	1 NC + 1 NO	C	Solder 2.8 x 0.5 mm	<b>51-253.0225</b>	1	0.011 kg
		1 NC + 1 NO	C	Solder	<b>51-256.0255</b>	1	0.011 kg
		2 NC + 2 NO	C	Solder	<b>51-259.0255</b>	2	0.011 kg

# 51 Raised design

Lens	Switching system	Contacts	Switching action	Terminal	Part No.	Wiring diagram	Weight
Plastic blue	Low-level element	1 NC	C	Universal 2.0 x 0.5 mm	<b>51-256.0266</b>	3	0.010 kg
		1 NC + 1 NO	C	Universal 2.0 x 0.5 mm	<b>51-253.0266</b>	5	0.011 kg
		2 NC	C	Universal 2.0 x 0.5 mm	<b>51-252.0266</b>	4	0.011 kg
	Snap-action switching element	1 NC + 1 NO	C	Solder 2.8 x 0.5 mm	<b>51-253.0226</b>	1	0.011 kg
		1 NC + 1 NO	C	Solder	<b>51-256.0256</b>	1	0.011 kg
		2 NC + 2 NO	C	Solder	<b>51-259.0256</b>	2	0.011 kg
Plastic grey	Low-level element	1 NC	C	Universal 2.0 x 0.5 mm	<b>51-256.0268</b>	3	0.010 kg
		1 NC + 1 NO	C	Universal 2.0 x 0.5 mm	<b>51-253.0268</b>	5	0.011 kg
		2 NC	C	Universal 2.0 x 0.5 mm	<b>51-252.0268</b>	4	0.011 kg
	Snap-action switching element	1 NC + 1 NO	C	Solder 2.8 x 0.5 mm	<b>51-253.0228</b>	1	0.011 kg
		1 NC + 1 NO	C	Solder	<b>51-256.0258</b>	1	0.011 kg
		2 NC + 2 NO	C	Solder	<b>51-259.0258</b>	2	0.011 kg
Plastic black	Low-level element	1 NC	C	Universal 2.0 x 0.5 mm	<b>51-256.0260</b>	3	0.010 kg
		1 NC + 1 NO	C	Universal 2.0 x 0.5 mm	<b>51-253.0260</b>	5	0.011 kg
		2 NC	C	Universal 2.0 x 0.5 mm	<b>51-252.0260</b>	4	0.011 kg
	Snap-action switching element	1 NC + 1 NO	C	Solder 2.8 x 0.5 mm	<b>51-253.0220</b>	1	0.011 kg
		1 NC + 1 NO	C	Solder	<b>51-256.0250</b>	1	0.011 kg
		2 NC + 2 NO	C	Solder	<b>51-259.0250</b>	2	0.011 kg

Contacts: NC = Normally closed, NO = Normally open  
Switching action: C = Maintained



## Mushroom-head complete, IP 65

### Equipment consisting of (schematic overview)



Each Part Number listed below includes all the black components shown in the 3D-drawing.

To obtain a complete unit, please select the red components from the pages shown.



Dimensions [mm]  
 H = Universal terminal 2.0 x 0.5 mm,  
 L = Solder terminal,  
 L1 = Solder terminal 2.8 x 0.5 mm



Product can differ from the current configuration.



Mounting cut-outs [mm]

### Additional Information

- If the anti-twist ring is not used the panel thickness increases to 4 mm

Lens	Switching system	Contacts	Switching action	Terminal	Part No.	Wiring diagram	Weight
 <b>Mushroom-head complete round, 24.5 mm</b>	Low-level element	1 NC	C	Universal 2.0 x 0.5 mm	<b>51-156.0262</b>	3	0.010 kg
		1 NC + 1 NO	C	Universal 2.0 x 0.5 mm	<b>51-153.0262</b>	5	0.011 kg
		2 NC	C	Universal 2.0 x 0.5 mm	<b>51-152.0262</b>	4	0.011 kg
	Snap-action switching element	1 NC + 1 NO	C	Solder 2.8 x 0.5 mm	<b>51-153.0222</b>	1	0.011 kg
		1 NC + 1 NO	B	Solder	<b>51-156.0252</b>	1	0.011 kg
		2 NC + 2 NO	C	Solder	<b>51-159.0252</b>	2	0.011 kg
Plastic yellow	Low-level element	1 NC	C	Universal 2.0 x 0.5 mm	<b>51-156.0264</b>	3	0.010 kg
		1 NC + 1 NO	C	Universal 2.0 x 0.5 mm	<b>51-153.0264</b>	5	0.011 kg
		2 NC	C	Universal 2.0 x 0.5 mm	<b>51-152.0264</b>	4	0.011 kg
	Snap-action switching element	1 NC + 1 NO	C	Solder 2.8 x 0.5 mm	<b>51-153.0224</b>	1	0.011 kg
		1 NC + 1 NO	B	Solder	<b>51-156.0254</b>	1	0.011 kg
		2 NC + 2 NO	C	Solder	<b>51-159.0254</b>	2	0.011 kg
Plastic green	Low-level element	1 NC	C	Universal 2.0 x 0.5 mm	<b>51-156.0265</b>	3	0.010 kg
		1 NC + 1 NO	C	Universal 2.0 x 0.5 mm	<b>51-153.0265</b>	5	0.011 kg
		2 NC	C	Universal 2.0 x 0.5 mm	<b>51-152.0265</b>	4	0.011 kg
	Snap-action switching element	1 NC + 1 NO	C	Solder 2.8 x 0.5 mm	<b>51-153.0225</b>	1	0.011 kg
		1 NC + 1 NO	B	Solder	<b>51-156.0255</b>	1	0.011 kg
		2 NC + 2 NO	C	Solder	<b>51-159.0255</b>	2	0.011 kg

# 51 Raised design

Lens	Switching system	Contacts	Switching action	Terminal	Part No.	Wiring diagram	Weight
Plastic blue	Low-level element	1 NC	C	Universal 2.0 x 0.5 mm	<b>51-156.0266</b>	3	0.010 kg
	Low-level element	1 NC + 1 NO	C	Universal 2.0 x 0.5 mm	<b>51-153.0266</b>	5	0.011 kg
	Low-level element	2 NC	C	Universal 2.0 x 0.5 mm	<b>51-152.0266</b>	4	0.011 kg
	Snap-action switching element	1 NC + 1 NO	C	Solder 2.8 x 0.5 mm	<b>51-153.0226</b>	1	0.011 kg
	Snap-action switching element	1 NC + 1 NO	B	Solder	<b>51-156.0256</b>	1	0.011 kg
	Snap-action switching element	2 NC + 2 NO	C	Solder	<b>51-159.0256</b>	2	0.011 kg
Plastic grey	Low-level element	1 NC	C	Universal 2.0 x 0.5 mm	<b>51-156.0268</b>	3	0.010 kg
	Low-level element	1 NC + 1 NO	C	Universal 2.0 x 0.5 mm	<b>51-153.0268</b>	5	0.011 kg
	Low-level element	2 NC	C	Universal 2.0 x 0.5 mm	<b>51-152.0268</b>	4	0.011 kg
	Snap-action switching element	1 NC + 1 NO	C	Solder 2.8 x 0.5 mm	<b>51-153.0228</b>	1	0.011 kg
	Snap-action switching element	1 NC + 1 NO	B	Solder	<b>51-156.0258</b>	1	0.011 kg
	Snap-action switching element	2 NC + 2 NO	C	Solder	<b>51-159.0258</b>	2	0.011 kg
Plastic black	Low-level element	1 NC	C	Universal 2.0 x 0.5 mm	<b>51-156.0260</b>	3	0.010 kg
	Low-level element	1 NC + 1 NO	C	Universal 2.0 x 0.5 mm	<b>51-153.0260</b>	5	0.011 kg
	Low-level element	2 NC	C	Universal 2.0 x 0.5 mm	<b>51-152.0260</b>	4	0.011 kg
	Snap-action switching element	1 NC + 1 NO	C	Solder 2.8 x 0.5 mm	<b>51-153.0220</b>	1	0.011 kg
	Snap-action switching element	1 NC + 1 NO	B	Solder	<b>51-156.0250</b>	1	0.011 kg
	Snap-action switching element	2 NC + 2 NO	C	Solder	<b>51-159.0250</b>	2	0.011 kg

Contacts: NC = Normally closed, NO = Normally open  
 Switching action: B = Momentary  
 Switching action: B = Momentary, C = Maintained

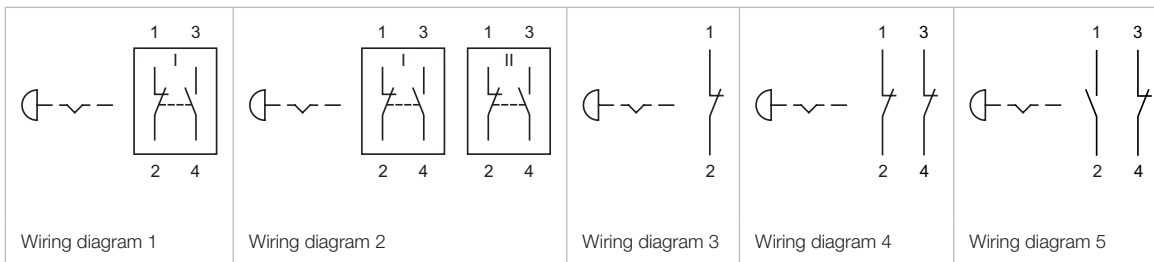

## Keylock switch 2 positions, IP 65

### Equipment consisting of (schematic overview)



Actuator



Anti-twist ring



Fixing nut



Dimensions [mm]  
 H = Universal terminal 2.0 x 0.5 mm,  
 L = Solder terminal,  
 L1 = Solder terminal 2.8 x 0.5 mm



Product can differ from the current configuration.

Each Part Number listed below includes all the black components shown in the 3D-drawing.



Mounting cut-outs [mm]

### Additional Information

- Front plastic black
- The standard lock: DOM 311
- Two keys are supplied with each key lock switch
- Optional lock numbers on request



Switching positions (A = Rest, B = Momentary, C = Maintained)

Switching system	Contacts	Switching action	Switching angle	Key remove	Terminal	Part No.	Component layout	Wiring diagram	Weight
 <b>Keylock switch 2 positions, Front dimension 18 x 18 mm</b>									
Low-level element	1 NC + 1 NO	A - B	B = 42°	A	Universal 2.0 x 0.5 mm	<b>51-458.036D</b>	4	1	0.017 kg
	2 NO	A - B	B = 42°	A	Universal 2.0 x 0.5 mm	<b>51-457.036D</b>	4	2	0.017 kg
	1 NC + 1 NO	A - C	C = 90°	A	Universal 2.0 x 0.5 mm	<b>51-445.036D</b>	4	7	0.017 kg
				C	Universal 2.0 x 0.5 mm	<b>51-448.036D</b>	4	7	0.017 kg
				A + C	Universal 2.0 x 0.5 mm	<b>51-442.036D</b>	4	7	0.017 kg
	2 NO	A - C	C = 90°	A	Universal 2.0 x 0.5 mm	<b>51-444.036D</b>	4	8	0.017 kg
				A + C	Universal 2.0 x 0.5 mm	<b>51-441.036D</b>	4	8	0.017 kg
	Snap-action switching element	1 NC + 1 NO	A - B	B = 42°	A	Solder 2.8 x 0.5 mm	<b>51-145.022D</b>		3
A					Solder	<b>51-145.025D2</b>		3	0.016 kg
2 NC + 2 NO		A - B	B = 42°	A	Solder	<b>51-146.025D2</b>		4	0.016 kg
4 NC + 4 NO		A - B	B = 42°	A	Solder	<b>51-148.025D2</b>		6	0.016 kg
1 NC + 1 NO		A - C	C = 90°	A	Solder	<b>51-255.025D2</b>		9	0.016 kg
				C	Solder	<b>51-355.025D2</b>		9	0.016 kg
				A + C	Solder	<b>51-155.025D2</b>		9	0.016 kg
				A	Solder 2.8 x 0.5 mm	<b>51-255.022D</b>		9	0.016 kg
			C	Solder 2.8 x 0.5 mm	<b>51-355.022D</b>		9	0.016 kg	

# 51 Raised design

Switching system	Contacts	Switching action	Switching angle	Key remove	Terminal	Part No.	Component layout	Wiring diagram	Weight
Snap-action switching element	1 NC + 1 NO	A - C	C = 90°	A + C	Solder 2.8 x 0.5 mm	<b>51-155.022D</b>		9	0.016 kg
				A	Solder	<b>51-256.025D2</b>		10	0.016 kg
				C	Solder	<b>51-356.025D2</b>		10	0.016 kg
	3 NC + 3 NO	A - C	C = 90°	A	Solder	<b>51-257.025D2</b>		11	0.016 kg
				A + C	Solder	<b>51-157.025D2</b>		11	0.016 kg
				A	Solder	<b>51-258.025D2</b>		12	0.016 kg
	4 NC + 4 NO	A - C	C = 90°	A	Solder	<b>51-358.025D2</b>		12	0.016 kg
				C	Solder	<b>51-358.025D2</b>		12	0.016 kg
				A + C	Solder	<b>51-158.025D2</b>		12	0.016 kg



## Keylock switch 2 positions, Front dimension 18 x 24 mm

Low-level element	1 NC + 1 NO	A - B	B = 42°	A	Universal 2.0 x 0.5 mm	<b>51-428.036D</b>	4	1	0.017 kg
				2 NO	A - B	B = 42°	A	Universal 2.0 x 0.5 mm	<b>51-427.036D</b>
	1 NC + 1 NO	A - C	C = 90°	A	Universal 2.0 x 0.5 mm	<b>51-405.036D</b>	4	7	0.017 kg
				C	Universal 2.0 x 0.5 mm	<b>51-408.036D</b>	4	7	0.017 kg
				A + C	Universal 2.0 x 0.5 mm	<b>51-402.036D</b>	4	7	0.017 kg
	2 NO	A - C	C = 90°	A	Universal 2.0 x 0.5 mm	<b>51-404.036D</b>	4	8	0.017 kg
				C	Universal 2.0 x 0.5 mm	<b>51-407.036D</b>	4	8	0.017 kg
				A + C	Universal 2.0 x 0.5 mm	<b>51-401.036D</b>	4	8	0.017 kg
	Snap-action switching element	1 NC + 1 NO	A - B	B = 42°	A	Solder 2.8 x 0.5 mm	<b>51-495.022D</b>		3
A					Solder	<b>51-495.025D2</b>		3	0.016 kg
2 NC + 2 NO		A - B	B = 42°	A	Solder	<b>51-496.025D2</b>		4	0.016 kg
3 NC + 3 NO		A - B	B = 42°	A	Solder	<b>51-497.025D2</b>		5	0.016 kg
4 NC + 4 NO		A - B	B = 42°	A	Solder	<b>51-498.025D2</b>		6	0.016 kg
1 NC + 1 NO		A - C	C = 90°	A	Solder	<b>51-295.025D2</b>		9	0.016 kg
				C	Solder	<b>51-395.025D2</b>		9	0.016 kg
				A + C	Solder	<b>51-195.025D2</b>		9	0.016 kg
				A	Solder 2.8 x 0.5 mm	<b>51-295.022D</b>		9	0.016 kg
				C	Solder 2.8 x 0.5 mm	<b>51-395.022D</b>		9	0.016 kg
				A + C	Solder 2.8 x 0.5 mm	<b>51-195.022D</b>		9	0.016 kg
2 NC + 2 NO		A - C	C = 90°	A	Solder	<b>51-296.025D2</b>		10	0.016 kg
				C	Solder	<b>51-396.025D2</b>		10	0.016 kg
				A + C	Solder	<b>51-196.025D2</b>		10	0.016 kg
3 NC + 3 NO		A - C	C = 90°	A	Solder	<b>51-297.025D2</b>		11	0.016 kg
				C	Solder	<b>51-397.025D2</b>		11	0.016 kg
				A + C	Solder	<b>51-197.025D2</b>		11	0.016 kg
4 NC + 4 NO		A - C	C = 90°	A	Solder	<b>51-298.025D2</b>		12	0.016 kg
	A + C			Solder	<b>51-198.025D2</b>		12	0.016 kg	

Switching system	Contacts	Switching action	Switching angle	Key remove	Terminal	Part No.	Component layout	Wiring diagram	Weight			
 <p><b>Keylock switch 2 positions, Front dimension Ø 18 mm</b></p>												
Low-level element	1 NC + 1 NO	A - B	B = 42°	A	Universal 2.0 x 0.5 mm	<b>51-438.036D</b>	4	1	0.017 kg			
		A - C	C = 90°	A	Universal 2.0 x 0.5 mm	<b>51-415.036D</b>	4	7	0.017 kg			
				C	Universal 2.0 x 0.5 mm	<b>51-418.036D</b>	4	7	0.017 kg			
				A + C	Universal 2.0 x 0.5 mm	<b>51-412.036D</b>	4	7	0.017 kg			
	2 NO	A - C	C = 90°	A	Universal 2.0 x 0.5 mm	<b>51-414.036D</b>	4	8	0.017 kg			
				A + C	Universal 2.0 x 0.5 mm	<b>51-411.036D</b>	4	8	0.017 kg			
Snap-action switching element	1 NC + 1 NO	A - B	B = 42°	A	Solder 2.8 x 0.5 mm	<b>51-141.022D</b>		3	0.016 kg			
				A	Solder	<b>51-141.025D2</b>		3	0.016 kg			
	2 NC + 2 NO	A - B	B = 42°	A	Solder	<b>51-142.025D2</b>		4	0.016 kg			
				A	Solder	<b>51-143.025D2</b>		5	0.016 kg			
	3 NC + 3 NO	A - B	B = 42°	A	Solder	<b>51-144.025D2</b>		6	0.016 kg			
	4 NC + 4 NO	A - B	B = 42°	A	Solder	<b>51-144.025D2</b>		6	0.016 kg			
				1 NC + 1 NO	A - C	C = 90°	A	Solder	<b>51-235.025D2</b>		9	0.016 kg
							C	Solder	<b>51-335.025D2</b>		9	0.016 kg
							A + C	Solder	<b>51-135.025D2</b>		9	0.016 kg
				A	Solder 2.8 x 0.5 mm	<b>51-235.022D</b>		9	0.016 kg			
						C	Solder 2.8 x 0.5 mm	<b>51-335.022D</b>		9	0.016 kg	
	A + C	Solder 2.8 x 0.5 mm	<b>51-135.022D</b>						9	0.016 kg		
	2 NC + 2 NO	A - C	C = 90°	A	Solder	<b>51-236.025D2</b>		10	0.016 kg			
				C	Solder	<b>51-336.025D2</b>		10	0.016 kg			
				A + C	Solder	<b>51-136.025D2</b>		10	0.016 kg			
	3 NC + 3 NO	A - C	C = 90°	A	Solder	<b>51-237.025D2</b>		11	0.016 kg			
				A + C	Solder	<b>51-137.025D2</b>		11	0.016 kg			
	4 NC + 4 NO	A - C	C = 90°	A	Solder	<b>51-238.025D2</b>		12	0.016 kg			
C				Solder	<b>51-338.025D2</b>		12	0.016 kg				
A + C				Solder	<b>51-138.025D2</b>		12	0.016 kg				

Contacts: NC = Normally closed, NO = Normally open  
 Switching action: A = Rest, B = Momentary, C = Maintain  
 The component layouts you will find from page 76

# 51 Raised design





**Keylock switch 3 positions, IP 65**

**Equipment consisting of (schematic overview)**



Each Part Number listed below includes all the black components shown in the 3D-drawing.



Dimensions [mm]



Product can differ from the current configuration.





Mounting cut-outs [mm]

**Additional Information**

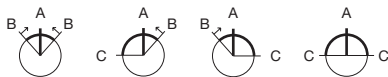
- Front plastic black
- The standard lock: DOM 311
- Two keys are supplied with each key lock switch
- Optional lock numbers on request



Switching positions (A = Rest, B = Momentary, C = Maintained)

Switching system	Contacts	Switching action	Switching angle	Key remove	Terminal	Part No.	Wiring diagram	Weight
 <p><b>Keylock switch 3 positions, Front dimension 18 x 18 mm</b></p>								
Snap-action switching element	2 NC + 2 NO	B - A - B	B = 42° / 42°	A	Solder 2.8 x 0.5 mm	<b>51-384.022D</b>	1	0.025 kg
		C - A - B	C = 90°, B = 42°	C + A	Solder 2.8 x 0.5 mm	<b>51-388.022D</b>	3	0.025 kg
		B - A - C	B = 42°, C = 90°	A	Solder 2.8 x 0.5 mm	<b>51-385.022D</b>	2	0.025 kg
		C - A - C	C = 90° / 90°	A	Solder 2.8 x 0.5 mm	<b>51-381.022D</b>	4	0.025 kg
				C + A + C	Solder 2.8 x 0.5 mm	<b>51-382.022D</b>	4	0.025 kg
 <p><b>Keylock switch 3 positions, Front dimension 18 x 24 mm</b></p>								
Snap-action switching element	2 NC + 2 NO	B - A - B	B = 42° / 42°	A	Solder 2.8 x 0.5 mm	<b>51-364.022D</b>	1	0.025 kg
		B - A - C	B = 42°, C = 90°	A	Solder 2.8 x 0.5 mm	<b>51-365.022D</b>	2	0.025 kg
				A + C	Solder 2.8 x 0.5 mm	<b>51-366.022D</b>	2	0.025 kg
				A	Solder 2.8 x 0.5 mm	<b>51-361.022D</b>	4	0.025 kg
		C - A - C	C = 90° / 90°	C + A + C	Solder 2.8 x 0.5 mm	<b>51-362.022D</b>	4	0.025 kg
				C + C	Solder 2.8 x 0.5 mm	<b>51-363.022D</b>	4	0.025 kg

# 51 Raised design

Switching system	Contacts	Switching action	Switching angle	Key remove	Terminal	Part No.	Wiring diagram	Weight
 <p><b>Keylock switch 3 positions, Front dimension Ø 18 mm</b></p>								
Snap-action switching element	2 NC + 2 NO	B - A - B	B = 42° / 42°	A	Solder 2.8 x 0.5 mm	<b>51-374.022D</b>	1	0.025 kg
		C - A - B	C = 90°, B = 42°	A	Solder 2.8 x 0.5 mm	<b>51-377.022D</b>	3	0.025 kg
				C + A	Solder 2.8 x 0.5 mm	<b>51-378.022D</b>	3	0.025 kg
		B - A - C	B = 42°, C = 90°	A + C	Solder 2.8 x 0.5 mm	<b>51-376.022D</b>	2	0.025 kg
		C - A - C	C = 90° / 90°	A	Solder 2.8 x 0.5 mm	<b>51-371.022D</b>	4	0.025 kg
				C + A + C	Solder 2.8 x 0.5 mm	<b>51-372.022D</b>	4	0.025 kg
		C + C	Solder 2.8 x 0.5 mm	<b>51-373.022D</b>	4	0.025 kg		

Contacts: NC = Normally closed, NO = Normally open  
 Switching action: A = Rest, B = Momentary, C = Maintain

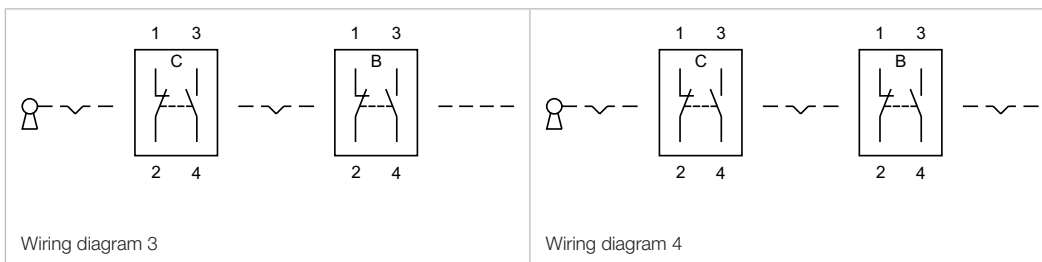
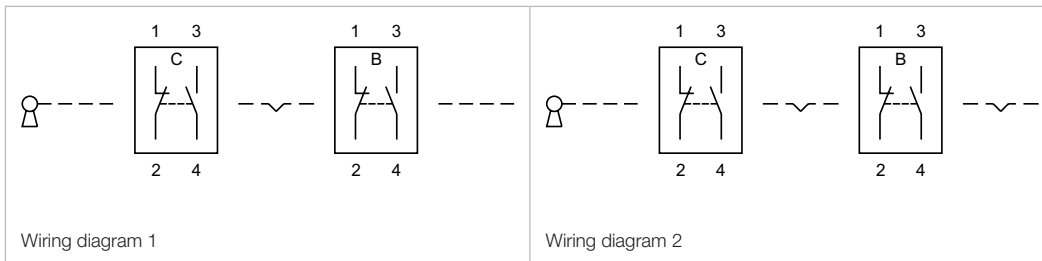

## Selector switch 2 positions, IP 65

### Equipment consisting of (schematic overview)

-  **Lever** page 58
-  **Single-LED** page 71
-  **Actuator**
-  **Anti-twist ring**
-  **Fixing nut**

Each Part Number listed below includes all the black components shown in the 3D-drawing.

To obtain a complete unit, please select the red components from the pages shown.



Dimensions [mm]  
 H = Universal terminal 2.0 x 0.5 mm,  
 H1 = Universal-Solder terminal,  
 L = Solder terminal,  
 L1 = Solder terminal 2.8 x 0.5 mm



Product can differ from the current configuration.



Mounting cut-outs [mm]

### Additional Information

- Illuminative



Switching positions (A = Rest, B = Momentary, C = Maintained)

Switching system	Contacts	Diode 1N4007	Switching action	Switching angle	Terminal	Part No.	Component layout	Wiring diagram	Weight
 Low-level element	1 NC		A - B	B = 42°	Universal 2.0 x 0.5 mm	<b>52-436.036</b>	4	1	0.007 kg
	1 NC + 1 NO		A - B	B = 42°	Universal 2.0 x 0.5 mm	<b>52-433.036</b>	4	2	0.007 kg
	1 NO		A - B	B = 42°	Universal 2.0 x 0.5 mm	<b>52-435.036</b>	4	3	0.007 kg
	2 NC		A - B	B = 42°	Universal 2.0 x 0.5 mm	<b>52-432.036</b>	4	4	0.007 kg
	2 NO		A - B	B = 42°	Universal 2.0 x 0.5 mm	<b>52-431.036</b>	4	5	0.007 kg
	1 NC		A - C	C = 90°	Universal 2.0 x 0.5 mm	<b>52-476.036</b>	4	15	0.007 kg
	1 NC + 1 NO		A - C	C = 90°	Universal 2.0 x 0.5 mm	<b>52-473.036</b>	4	16	0.007 kg
	1 NO		A - C	C = 90°	Universal 2.0 x 0.5 mm	<b>52-475.036</b>	4	17	0.007 kg
	2 NC		A - C	C = 90°	Universal 2.0 x 0.5 mm	<b>52-472.036</b>	4	18	0.007 kg
	2 NO		A - C	C = 90°	Universal 2.0 x 0.5 mm	<b>52-471.036</b>	4	19	0.007 kg
Snap-action switching element	1 NC + 1 NO	1	A - B	B = 42°	Universal-Solder	<b>52-743.0292</b>	6		0.008 kg
		2	A - B	B = 42°	Universal-Solder	<b>52-744.0292</b>	7		0.008 kg
			A - B	B = 42°	Solder	<b>52-131.0252</b>	8		0.006 kg
			A - B	B = 42°	Solder 2.8 x 0.5 mm	<b>52-131.022</b>	9		0.006 kg

# 51 Raised design

Switching system	Contacts	Diode 1N4007	Switching action	Switching angle	Terminal	Part No.	Component layout	Wiring diagram	Weight
Snap-action switching element	2 NC + 2 NO	1	A - B	B = 42°	Universal-Solder	<b>52-745.0292</b>		10	0.010 kg
		2	A - B	B = 42°	Universal-Solder	<b>52-746.0292</b>		11	0.010 kg
			A - B	B = 42°	Solder	<b>52-132.0252</b>		12	0.006 kg
	3 NC + 3 NO		A - B	B = 42°	Solder	<b>52-133.0252</b>		13	0.006 kg
	4 NC + 4 NO		A - B	B = 42°	Solder	<b>52-134.0252</b>		14	0.006 kg
	1 NC + 1 NO	1	A - C	C = 90°	Universal-Solder	<b>52-747.0292</b>		20	0.008 kg
			A - C	C = 90°	Universal-Solder	<b>52-748.0292</b>		21	0.008 kg
			A - C	C = 90°	Solder	<b>52-271.0252</b>		22	0.006 kg
			A - C	C = 90°	Solder 2.8 x 0.5 mm	<b>52-271.022</b>		23	0.006 kg
	2 NC + 2 NO	1	A - C	C = 90°	Universal-Solder	<b>52-749.0292</b>		24	0.010 kg
			A - C	C = 90°	Universal-Solder	<b>52-750.0292</b>		25	0.010 kg
		2	A - C	C = 90°	Solder	<b>52-272.0252</b>		26	0.006 kg
	3 NC + 3 NO		A - C	C = 90°	Solder	<b>52-273.0252</b>		27	0.006 kg
	4 NC + 4 NO		A - C	C = 90°	Solder	<b>52-274.0252</b>		28	0.006 kg

Contacts: NC = Normally closed, NO = Normally open  
 Switching action: A = Rest, B = Momentary, C = Maintain  
 The component layouts you will find from page 76

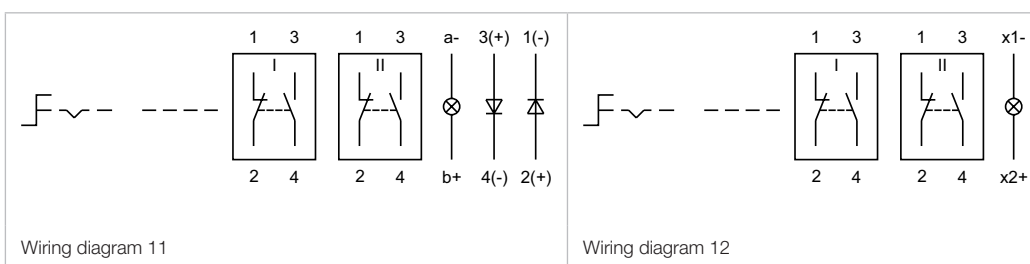
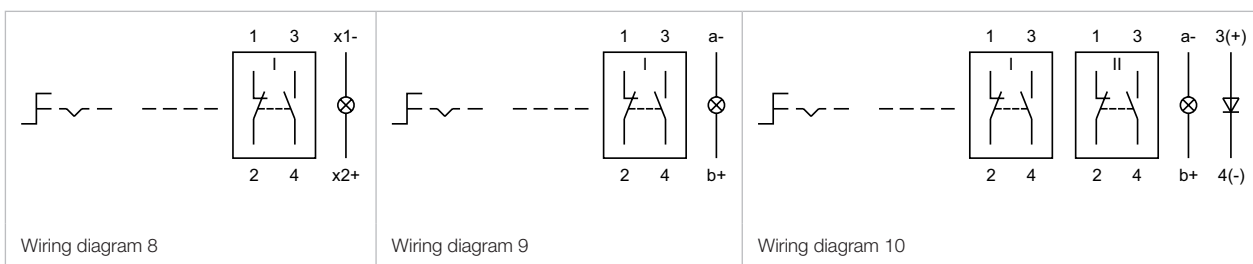
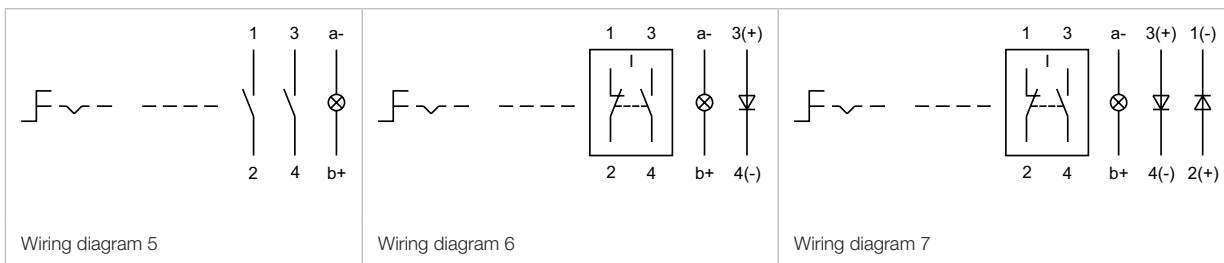



# 51 Raised design

## Selector switch 3 positions, IP 65



Product can differ from the current configuration.



Dimensions [mm]

### Equipment consisting of (schematic overview)



Each Part Number listed below includes all the black components shown in the 3D-drawing.

*To obtain a complete unit, please select the red components from the pages shown.*

### Additional Information

- Illuminative

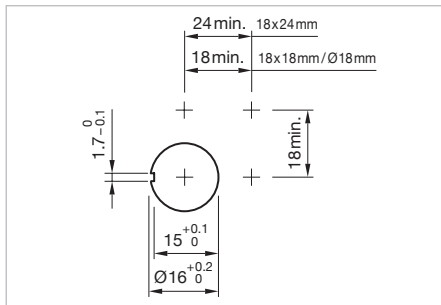

Mounting cut-outs [mm]



Switching positions (A = Rest, B = Momentary, C = Maintained)

Switching system	Contacts	Switching action	Switching angle	Terminal	Part No.	Wiring diagram	Weight
 <b>Selector switch 3 positions, Front dimension Ø 18 mm</b>							
Snap-action switching element	2 NC + 2 NO	B - A - B	B = 42° / 42°	Solder 2.8 x 0.5 mm	<b>52-572.022A</b>	1	0.015 kg
		C - A - B	C = 90°, B = 42°	Solder 2.8 x 0.5 mm	<b>52-574.022A</b>	2	0.015 kg
		B - A - C	B = 42°, C = 90°	Solder 2.8 x 0.5 mm	<b>52-573.022A</b>	3	0.015 kg
		C - A - C	C = 90° / 90°	Solder 2.8 x 0.5 mm	<b>52-571.022A</b>	4	0.015 kg

Contacts: NC = Normally closed, NO = Normally open  
 Switching action: A = Rest, B = Momentary, C = Maintain



# 51 Raised design

Front

## Lens flush design

### Additional Information

- Lens surface mat
- Lens profile flat

Product attribute	Dimension	Lens	Part No.	Weight
 <b>Lens plastic, flush design</b>				
illuminative	18 x 18 mm	smoked transparent	<b>61-9671.1</b>	0.002 kg
		red transparent	<b>61-9671.2</b>	0.002 kg
		orange transparent	<b>61-9671.3</b>	0.002 kg
		yellow transparent	<b>61-9671.4</b>	0.002 kg
		green transparent	<b>61-9671.5</b>	0.002 kg
		blue transparent	<b>61-9671.6</b>	0.002 kg
		colourless transparent	<b>61-9671.7</b>	0.002 kg
non-illuminative	18 x 18 mm	black opaque	<b>61-9771.0</b>	0.002 kg
		grey opaque	<b>61-9771.8</b>	0.002 kg
		white translucent	<b>61-9771.9</b>	0.002 kg
 <b>Lens plastic, flush design</b>				
illuminative	18 x 24 mm	smoked transparent	<b>61-9681.1</b>	0.002 kg
		red transparent	<b>61-9681.2</b>	0.002 kg
		orange transparent	<b>61-9681.3</b>	0.002 kg
		yellow transparent	<b>61-9681.4</b>	0.002 kg
		green transparent	<b>61-9681.5</b>	0.002 kg
		blue transparent	<b>61-9681.6</b>	0.002 kg
		colourless transparent	<b>61-9681.7</b>	0.002 kg
non-illuminative	18 x 24 mm	black opaque	<b>61-9781.0</b>	0.002 kg
		white translucent	<b>61-9781.9</b>	0.002 kg
 <b>Lens plastic, flush design</b>				
illuminative	Ø 19.7 mm	smoked transparent	<b>61-9642.1</b>	0.002 kg
		red transparent	<b>61-9642.2</b>	0.002 kg
		orange transparent	<b>61-9642.3</b>	0.002 kg
		yellow transparent	<b>61-9642.4</b>	0.002 kg
		green transparent	<b>61-9642.5</b>	0.002 kg
		blue transparent	<b>61-9642.6</b>	0.002 kg
		colourless transparent	<b>61-9642.7</b>	0.002 kg



Lens raised design

Product attribute	Dimension	Lens	Part No.	Weight
 <p><b>Lens plastic, raised design</b></p>				
flat, illuminative	15.3 x 15.3 mm	smoked transparent	<b>51-953.1</b>	0.001 kg
		red transparent	<b>51-953.2</b>	0.001 kg
		orange transparent	<b>51-953.3</b>	0.001 kg
		yellow transparent	<b>51-953.4</b>	0.001 kg
		green transparent	<b>51-953.5</b>	0.001 kg
		blue transparent	<b>51-953.6</b>	0.001 kg
		colourless transparent	<b>51-953.7</b>	0.001 kg
flat, illuminative, not suitable for film insert	15.3 x 15.3 mm	red translucent	<b>51-951.2</b>	0.001 kg
		orange translucent	<b>51-951.3</b>	0.001 kg
		yellow translucent	<b>51-951.4</b>	0.001 kg
		green translucent	<b>51-951.5</b>	0.001 kg
		blue translucent	<b>51-951.6</b>	0.001 kg
		white translucent	<b>51-951.9</b>	0.001 kg
flat, illuminative, less suitable for film insert	15.3 x 15.3 mm	red transparent	<b>51-955.2</b>	0.001 kg
		yellow transparent	<b>51-955.4</b>	0.001 kg
		green transparent	<b>51-955.5</b>	0.001 kg
		colourless transparent	<b>51-955.7</b>	0.001 kg
flat, non-illuminative	15.3 x 15.3 mm	black opaque	<b>51-951.0</b>	0.001 kg
		grey opaque	<b>51-951.8</b>	0.001 kg
 <p><b>Lens plastic, raised design</b></p>				
concave, illuminative	15.3 x 15.3 mm	red transparent	<b>51-954.2</b>	0.001 kg
		orange transparent	<b>51-954.3</b>	0.001 kg
		yellow transparent	<b>51-954.4</b>	0.001 kg
		green transparent	<b>51-954.5</b>	0.001 kg
		blue transparent	<b>51-954.6</b>	0.001 kg
		colourless transparent	<b>51-954.7</b>	0.001 kg
 <p><b>Lens plastic, raised design</b></p>				
flat, illuminative	15.3 x 21.5 mm	smoked transparent	<b>51-903.1</b>	0.001 kg
		red transparent	<b>51-903.2</b>	0.001 kg
		orange transparent	<b>51-903.3</b>	0.001 kg
		yellow transparent	<b>51-903.4</b>	0.001 kg
		green transparent	<b>51-903.5</b>	0.001 kg
		blue transparent	<b>51-903.6</b>	0.001 kg
		colourless transparent	<b>51-903.7</b>	0.001 kg

# 51 Raised design

Product attribute	Dimension	Lens	Part No.	Weight
flat, illuminative, not suitable for film insert	15.3 x 21.5 mm	red translucent	<b>51-901.2</b>	0.001 kg
		orange translucent	<b>51-901.3</b>	0.001 kg
		yellow translucent	<b>51-901.4</b>	0.001 kg
		green translucent	<b>51-901.5</b>	0.001 kg
		blue translucent	<b>51-901.6</b>	0.001 kg
		white translucent	<b>51-901.9</b>	0.001 kg
flat, illuminative, less suitable for film insert	15.3 x 21.5 mm	red transparent	<b>51-905.2</b>	0.001 kg
		yellow transparent	<b>51-905.4</b>	0.001 kg
		green transparent	<b>51-905.5</b>	0.001 kg
		colourless transparent	<b>51-905.7</b>	0.001 kg
flat, non-illuminative	15.3 x 21.5 mm	black opaque	<b>51-901.0</b>	0.001 kg
		grey opaque	<b>51-901.8</b>	0.001 kg
 <p><b>Lens plastic, raised design</b></p>				
concave, illuminative	15.3 x 21.5 mm	red transparent	<b>51-904.2</b>	0.001 kg
		orange transparent	<b>51-904.3</b>	0.001 kg
		yellow transparent	<b>51-904.4</b>	0.001 kg
		green transparent	<b>51-904.5</b>	0.001 kg
		blue transparent	<b>51-904.6</b>	0.001 kg
		colourless transparent	<b>51-904.7</b>	0.001 kg
concave, illuminative, less suitable for film insert	15.3 x 21.5 mm	red transparent	<b>51-906.2</b>	0.001 kg
		yellow transparent	<b>51-906.4</b>	0.001 kg
		green transparent	<b>51-906.5</b>	0.001 kg
		colourless transparent	<b>51-906.7</b>	0.001 kg
 <p><b>Lens plastic, raised design</b></p>				
flat, illuminative	Ø 15.8 mm	smoked transparent	<b>51-933.1</b>	0.001 kg
		red transparent	<b>51-933.2</b>	0.001 kg
		orange transparent	<b>51-933.3</b>	0.001 kg
		yellow transparent	<b>51-933.4</b>	0.001 kg
		green transparent	<b>51-933.5</b>	0.001 kg
		blue transparent	<b>51-933.6</b>	0.001 kg
		colourless transparent	<b>51-933.7</b>	0.001 kg
		red translucent	<b>51-931.2</b>	0.001 kg
flat, illuminative, not suitable for film insert	Ø 15.8 mm	orange translucent	<b>51-931.3</b>	0.001 kg
		yellow translucent	<b>51-931.4</b>	0.001 kg
		green translucent	<b>51-931.5</b>	0.001 kg
		blue translucent	<b>51-931.6</b>	0.001 kg
		white translucent	<b>51-931.9</b>	0.001 kg
		red transparent	<b>51-935.2</b>	0.001 kg
flat, illuminative, less suitable for film insert	Ø 15.8 mm	yellow transparent	<b>51-935.4</b>	0.001 kg
		green transparent	<b>51-935.5</b>	0.001 kg
		colourless transparent	<b>51-935.7</b>	0.001 kg
		black opaque	<b>51-931.0</b>	0.001 kg
flat, non-illuminative	Ø 15.8 mm	grey opaque	<b>51-931.8</b>	0.001 kg

**Lens plastic with symbol**

**Additional Information**

- Lens profile flat
- Illuminative
- The silvery coat is being applied on the lens (screen print) with an additional protective lacquer. Further information see «Technical data»

Dimension	Lens	Symbol	Part No.	Weight
 <p><b>Lens plastic with symbol, flush design</b></p>				
Ø 19.7 mm	red transparent	Ring	<b>61-9643.201</b>	0.002 kg
	orange transparent	Ring	<b>61-9643.301</b>	0.002 kg
	yellow transparent	Ring	<b>61-9643.401</b>	0.002 kg
	green transparent	Ring	<b>61-9643.501</b>	0.002 kg
	blue transparent	Ring	<b>61-9643.601</b>	0.002 kg
	colourless transparent	Ring	<b>61-9643.701</b>	0.002 kg
 <p><b>Lens plastic with symbol, flush design</b></p>				
Ø 19.7 mm	red transparent	ON/OFF	<b>61-9643.202</b>	0.002 kg
	green transparent	ON/OFF	<b>61-9643.502</b>	0.002 kg
	blue transparent	ON/OFF	<b>61-9643.602</b>	0.002 kg
	colourless transparent	ON/OFF	<b>61-9643.702</b>	0.002 kg
 <p><b>Lens plastic with symbol, flush design</b></p>				
Ø 19.7 mm	red transparent	Stand by	<b>61-9643.203</b>	0.002 kg
	green transparent	Stand by	<b>61-9643.503</b>	0.002 kg
	blue transparent	Stand by	<b>61-9643.603</b>	0.002 kg
	colourless transparent	Stand by	<b>61-9643.703</b>	0.002 kg

**Marking plate**

**Additional Information**

- Can be hot stamped
- Only applicable with lens round  
Part No. 61-9642.X

Marking plate	Part No.	Weight
 <p><b>Marking plate for lens plastic round, flush design</b></p>		
colourless transparent	<b>61-9707.7</b>	0.001 kg

# 51 Accessories

## Lens metal with spot

### Additional Information

- Lens surface mat
- Lens profile flat
- Illuminative

Dimension	Lens	Part No.	Weight
 <p><b>Lens metal with spot, flush design</b></p>	Aluminium black anodized	<b>61-9841.0A</b>	0.002 kg
	Aluminium red anodized	<b>61-9841.2A</b>	0.002 kg
	Aluminium gold anodized	<b>61-9841.4A</b>	0.002 kg
	Aluminium olive-green anodized	<b>61-9841.5A</b>	0.002 kg
	Aluminium blue anodized	<b>61-9841.6A</b>	0.002 kg
	Aluminium natural anodized	<b>61-9841.8A</b>	0.002 kg
	Ø 19.7 mm		

## Lens metal

### Additional Information

- Lens surface mat
- Non-illuminative
- The colour of anodized aluminium parts can vary due to technical production reasons

Product attribute	Dimension	Lens	Part No.	Weight	
 <p><b>Lens metal, flush design</b></p>	flat	Ø 19.7 mm	Aluminium black anodized	<b>61-9841.0</b>	0.002 kg
			Aluminium red anodized	<b>61-9841.2</b>	0.002 kg
			Aluminium gold anodized	<b>61-9841.4</b>	0.002 kg
			Aluminium olive-green anodized	<b>61-9841.5</b>	0.002 kg
			Aluminium blue anodized	<b>61-9841.6</b>	0.002 kg
			Aluminium natural anodized	<b>61-9841.8</b>	0.002 kg
 <p><b>Lens metal, flush design</b></p>	convex (domed)	Ø 19.7 mm	Aluminium black anodized	<b>61-9842.0</b>	0.003 kg
			Aluminium red anodized	<b>61-9842.2</b>	0.003 kg
			Aluminium olive-green anodized	<b>61-9842.5</b>	0.003 kg
			Aluminium blue anodized	<b>61-9842.6</b>	0.003 kg
			Aluminium natural anodized	<b>61-9842.8</b>	0.003 kg

**Mushroom-head cap****Additional Information**

- Non-illuminative

Mushroom-head cap	Part No.	Weight
 <b>Mushroom-head cap, flush design, Front dimension Ø 32 mm</b>		
Plastic black	<b>61-9593.0</b>	0.004 kg
Plastic red	<b>61-9593.2</b>	0.004 kg
Plastic yellow	<b>61-9593.4</b>	0.004 kg
Plastic green	<b>61-9593.5</b>	0.004 kg

**Front bezel for selector switch square****Additional Information**

- The dimensions of the mounting cut-outs are shown in the product details
- Please note that bigger minimum distances are necessary

Dimension	Front bezel	Part No.	Weight
 <b>Front bezel for selector switch square, raised design</b>			
24 x 24 mm	Plastic black	<b>52-950.0</b>	0.001 kg
26 x 26 mm	Plastic black	<b>52-952.0</b>	0.001 kg

## Lever flush design

### Additional Information

- With bar and marking dot

Lever illumination	Lever	Bar colour	Part No.	Weight
 <b>Lever flush design</b>				
illuminative	Plastic black	red	<b>61-9028.20</b>	0.001 kg
		yellow	<b>61-9028.40</b>	0.001 kg
		green	<b>61-9028.50</b>	0.001 kg
		blue	<b>61-9028.60</b>	0.001 kg
	Plastic grey	red	<b>61-9029.20</b>	0.001 kg
		orange	<b>61-9029.30</b>	0.001 kg
		yellow	<b>61-9029.40</b>	0.001 kg
non-illuminative	Plastic black	black	<b>61-9028.0</b>	0.001 kg
		white	<b>61-9028.9</b>	0.001 kg
	Plastic grey	grey	<b>61-9029.8</b>	0.001 kg
		white	<b>61-9029.9</b>	0.001 kg

## Lever raised design

### Additional Information

- With bar and marking dot

Lever illumination	Lever	Bar colour	Part No.	Weight
 <b>Lever raised design</b>				
illuminative	Plastic black	red	<b>52-928.20</b>	0.001 kg
	Plastic black	orange	<b>52-928.30</b>	0.001 kg
	Plastic black	yellow	<b>52-928.40</b>	0.001 kg
	Plastic black	green	<b>52-928.50</b>	0.001 kg
	Plastic black	blue	<b>52-928.60</b>	0.001 kg
	Plastic grey	red	<b>52-929.20</b>	0.001 kg
	Plastic grey	orange	<b>52-929.30</b>	0.001 kg
	Plastic grey	yellow	<b>52-929.40</b>	0.001 kg
	Plastic grey	green	<b>52-929.50</b>	0.001 kg
	Plastic grey	blue	<b>52-929.60</b>	0.001 kg
non-illuminative	Plastic black	black	<b>52-928.0</b>	0.001 kg
	Plastic black	white	<b>52-928.9</b>	0.001 kg
	Plastic grey	grey	<b>52-929.8</b>	0.001 kg
	Plastic grey	white	<b>52-929.9</b>	0.001 kg

**Legend frame**

**Additional Information**

- For devices with front dimension  $\varnothing 25$  mm, flush design
- The colour of anodized aluminium parts can vary due to technical production reasons



Dimensions [mm]

Dimension	Material	Colour	Mounting type	Part No.	Weight
 <p><b>Legend frame</b></p>					
30 x 50 x 0.75 mm	Aluminium	black anodized	adhesive	<b>61-9980.0</b>	0.001 kg

**Legend plate**

**Additional Information**

- For legend frame Part No. 61-9980.0
- The colour of anodized aluminium parts can vary due to technical production reasons

Dimension	Material	Colour	Mounting type	Part No.	Weight
 <p><b>Legend plate for legend frame</b></p>					
14.5 x 23.5 mm	Aluminium	natural anodized	adhesive	<b>704.968.0</b>	0.001 kg
		black anodized	adhesive	<b>704.968.1</b>	0.001 kg

## Front bezel set

### Additional Information

- The dimensions of the mounting cut-outs are shown in the product details
- The colour of anodized aluminium parts can vary due to technical production reasons

Mounting cut-out	Front bezel	Part No.	Weight	
 <p><b>Front bezel set for indicator and illuminated pushbutton, flush design, Front dimension 24 x 24 mm</b></p>				
	21 x 21 mm	Plastic black	<b>61-9930.0</b>	0.008 kg
	Plastic silver	<b>61-9930.4</b>	0.008 kg	
 <p><b>Front bezel set for indicator and illuminated pushbutton, flush design, Front dimension 24 x 30 mm</b></p>				
	21 x 27 mm	Plastic black	<b>61-9931.0</b>	0.008 kg
	Plastic silver	<b>61-9931.4</b>	0.008 kg	
 <p><b>Front bezel set for indicator and illuminated pushbutton, flush design, Front dimension Ø 25 mm</b></p>				
	Ø 22.5 mm	Aluminium natural anodized	<b>61-9933.0</b>	0.006 kg
		Aluminium black anodized	<b>61-9933.1</b>	0.006 kg
		Aluminium red anodized	<b>61-9933.2</b>	0.006 kg
		Aluminium gold anodized	<b>61-9933.4</b>	0.006 kg
		Aluminium olive-green anodized	<b>61-9933.5</b>	0.006 kg
		Aluminium blue anodized	<b>61-9933.6</b>	0.006 kg
Plastic black		<b>61-9933.10</b>	0.008 kg	



**Front bezel set**

**Additional Information**

- Please note that bigger minimum distances are necessary
- The colour of anodized aluminium parts can vary due to technical production reasons

Dimension	Mounting cut-out	Front bezel	Part No.	Weight
 <p><b>Front bezel set for mushroom-head pushbutton, flush design</b></p>				
Ø 25 mm	Ø 22.5 mm	Aluminium natural anodized	<b>61-9933.0</b>	0.006 kg
		Aluminium black anodized	<b>61-9933.1</b>	0.006 kg
		Plastic black	<b>61-9933.10</b>	0.008 kg
		Aluminium red anodized	<b>61-9933.2</b>	0.006 kg
		Aluminium gold anodized	<b>61-9933.4</b>	0.006 kg
		Aluminium olive-green anodized	<b>61-9933.5</b>	0.006 kg
		Aluminium blue anodized	<b>61-9933.6</b>	0.006 kg
 <p><b>Front bezel set for mushroom-head pushbutton, flush design, Front dimension Ø 40 mm</b></p>				
	Ø 22.5 mm	Aluminium natural anodized	<b>61-9934.8</b>	0.013 kg

## Front bezel set keylock switch

### Additional Information

- The Dimensions [mm] of the Mounting cut-outs [mm] are shown in the product details
- For the round front bezel sets the anti-twist ring is part of the sales-package
- The colour of anodized aluminium parts can vary due to technical production reasons

Mounting cut-out	Front bezel	Part No.	Weight	
 <p><b>Front bezel set for keylock switch, flush design, Front dimension 24 x 24 mm</b></p>				
	21 x 21 mm	Plastic black	<b>61-9930.0</b>	0.008 kg
	Plastic silver	<b>61-9930.4</b>	0.008 kg	
 <p><b>Front bezel set for keylock switch, flush design, Front dimension 24 x 30 mm</b></p>				
	21 x 27 mm	Plastic black	<b>61-9931.0</b>	0.008 kg
	Plastic silver	<b>61-9931.4</b>	0.008 kg	
 <p><b>Front bezel set for keylock switch, flush design, Front dimension Ø 25 mm</b></p>				
	Ø 22.5 mm	Aluminium natural anodized	<b>61-9932.0</b>	0.006 kg
		Aluminium black anodized	<b>61-9932.1</b>	0.006 kg
		Aluminium red anodized	<b>61-9932.2</b>	0.006 kg
		Aluminium gold anodized	<b>61-9932.4</b>	0.006 kg
		Aluminium olive-green anodized	<b>61-9932.5</b>	0.006 kg
		Aluminium blue anodized	<b>61-9932.6</b>	0.006 kg
Plastic black	<b>61-9932.10</b>	0.008 kg		

**Front bezel set for selector switch**

**Additional Information**

- The dimensions of the mounting cut-outs are shown in the product details
- For the round front bezel sets the anti-twist ring is part of the sales-package
- The colour of anodized aluminium parts can vary due to technical production reasons

Mounting cut-out	Front bezel	Part No.	Weight
 <p><b>Front bezel set for selector switch, flush design, Front dimension 24 x 24 mm</b></p>			
21 x 21 mm	Plastic black	<b>61-9936.0</b>	0.007 kg
 <p><b>Front bezel set for selector switch, flush design, Front dimension Ø 25 mm</b></p>			
Ø 22.5 mm	Aluminium natural anodized	<b>61-9932.0</b>	0.006 kg
	Aluminium black anodized	<b>61-9932.1</b>	0.006 kg
	Aluminium red anodized	<b>61-9932.2</b>	0.006 kg
	Aluminium gold anodized	<b>61-9932.4</b>	0.006 kg
	Aluminium olive-green anodized	<b>61-9932.5</b>	0.006 kg
	Aluminium blue anodized	<b>61-9932.6</b>	0.006 kg
	Plastic black	<b>61-9932.10</b>	0.008 kg

**Front protective cap, IP 68**

**Additional Information**

- For lenses with flat profile only
- When using the front protection cover for push buttons the external sealing in the front bezel set and the silicone bellows in the actuator are to be removed

Product attribute	Material	Colour	Optics	Part No.	Weight
 <p><b>Front protective cap</b></p>					
for front bezel set 24 x 30 mm, flush design	Silicone	colourless	transparent	<b>61-9927.2</b>	0.001 kg
 <p><b>Front protective cap</b></p>					
for front bezel set Ø 25 mm, flush design	Silicone	colourless	transparent	<b>84-9103.7</b>	0.001 kg

# 51 Accessories

## Protective cover flush design, IP 65

### Additional Information

- The Dimensions [mm] of the Mounting cut-outs [mm] are shown in the product details
- Please note that bigger minimum distances are necessary



Dimensions [mm]

Product attribute	Dimension	Mounting cut-out	Material	Optics	Part No.	Weight
 <p><b>Protective cover flush design</b></p>						
hinged, with means for sealing	24 x 24 mm	21 x 21 mm	Plastic	transparent	<b>61-9921.0</b>	0.006 kg
 <p><b>Protective cover flush design</b></p>						
hinged, with means for sealing	24 x 30 mm	21 x 27 mm	Plastic	transparent	<b>61-9922.0</b>	0.006 kg
 <p><b>Protective cover flush design</b></p>						
slide by side, with means not for sealing	Ø 25 mm	Ø 22.5 mm	Plastic	transparent	<b>61-9924.0</b>	0.006 kg

**Protective cover raised design, IP 65**

**Additional Information**

- Hinged, with means for sealing
- The dimensions of the mounting cut-outs are shown in the product details
- Please note that bigger minimum distances are necessary





Dimensions [mm]

Dimension	Mounting cut-out	Material	Optics	Part No.	Weight
	<b>Protective cover raised design</b>				
18 x 18 mm	Ø 16 mm	Plastic	transparent	<b>51-920</b>	0.002 kg
	<b>Protective cover raised design</b>				
18 x 24 mm	Ø 16 mm	Plastic	transparent	<b>51-925</b>	0.002 kg

**Blind plug flush design**

**Additional Information**

- The dimensions of the mounting cut-outs are shown in the product details

Dimension	Mounting cut-out	Material	Colour	Part No.	Weight
	<b>Blind plug flush design</b>				
24 x 24 mm	21 x 21 mm	Plastic	black	<b>61-9451.0</b>	0.006 kg
	<b>Blind plug flush design</b>				
24 x 30 mm	21 x 27 mm	Plastic	black	<b>61-9452.0</b>	0.006 kg
	<b>Blind plug flush design</b>				
Ø 25 mm	Ø 22.5 mm	Plastic	black	<b>61-9453.0</b>	0.006 kg

# 51 Accessories

## Blind plug raised design

### Additional Information

- The dimensions of the mounting cut-outs are shown in the product details
- Blind plugs fit also in mounting cut-outs with anti-twist device

Dimension	Mounting cut-out	Material	Colour	Part No.	Weight
 <b>Blind plug raised design</b>					
18 x 18 mm	Ø 16 mm	Plastic	black	<b>51-948.0</b>	0.003 kg
 <b>Blind plug raised design</b>					
18 x 24 mm	Ø 16 mm	Plastic	black	<b>51-947.0</b>	0.003 kg
 <b>Blind plug raised design</b>					
Ø 18 mm	Ø 16 mm	Plastic	black	<b>51-949.0</b>	0.003 kg

## Master key

### Additional Information

- For standard lock: DOM 311 ... 445

Part No.	Weight
 <b>Master key</b>	
<b>31-989.300</b>	0.006 kg

**Spare key**

**Additional Information**

- For standard lock: DOM 311
- Optional lock numbers on request

Part No.	Weight
 <p data-bbox="272 633 389 663"><b>Spare key</b></p>	
31-989.311	0.006 kg

**EMC key protection cap**

**Additional Information**

- Plastic black
- For standard lock: DOM

Part No.	Weight
 <p data-bbox="272 1209 549 1238"><b>EMC key protection cap</b></p>	
31-985.0	0.005 kg

## PCB plug-in base

### Additional Information

- PCB plug-in base pins right-angle: With the extendable mounting the distance between plug-in base and PCB can be varied up to 3 mm



Dimensions

Product attribute	Pins	Terminal	Part No.	Component layout	Weight
 <p><b>PCB plug-in base</b> for low level switching element</p>	axial	PCB	<b>31-940</b>	3	0.002 kg
 <p><b>PCB plug-in base</b> for low level switching element</p>	right-angled	PCB	<b>31-941</b>	1	0.004 kg
 <p><b>PCB plug-in base</b> for snap-action switching element 2.8 mm</p>	axial	PCB	<b>31-942</b>	2	0.002 kg

The component layouts you will find from page 76



**Multi-plug housing**

**Additional Information**

- For switching block

Part No.	Weight
 <p data-bbox="272 595 488 629"><b>Multi-plug housing</b></p>	
51-943.0	0.005 kg

## Flat receptacle

Product attribute	Part No.	Weight
 <p><b>Flat receptacle</b></p>		
2.0 x 0.5 mm plug-in terminal	<b>31-945</b>	0.001 kg
 <p><b>Flat receptacle</b></p>		
2.8 x 0.5 mm plug-in terminal	<b>31-946</b>	0.001 kg
 <p><b>Flat receptacle</b></p>		
2.8 x 0.5 mm multi-plug housing	<b>51-943.1</b>	0.001 kg

## Insulation sleeve

Product attribute	Part No.	Weight
 <p><b>Insulation sleeve</b></p>		
Cover plug-in terminals for snap-action switching element 2.8 mm	<b>01-928</b>	0.001 kg
 <p><b>Insulation sleeve</b></p>		
for flat receptacle 2.0 mm	<b>31-928</b>	0.001 kg
 <p><b>Insulation sleeve</b></p>		
for flat receptacle 2.8 mm	<b>31-929</b>	0.001 kg

## Terminal cover

Part No.	Weight
 <p><b>Terminal cover for snap-action switching element 16</b></p>	
<b>01-929</b>	0.010 kg

**Illumination**

**LED, T1 3/4 MG**

**Additional Information**

- Due to high surface temperatures, the series resistor must not be soldered directly to the terminals of the equipment (use a terminal plate)• When using AC/DC types with AC operation, slight flickering can occur
- Luminous intensity data of the LEDs on direct voltage
- Electrical and optical data are measured at 25 °C
- The specified versions are built with a protection diode (half wave rectifier) in series and the LED
- When using AC/DC types with AC operation, slight flickering can occur
- Luminosity and wave length variations caused by LED manufacturing processes may cause slight differences regarding the illumination
- For supply voltages above 48 V, it is necessary to use a voltage reduction element (external series resistor or transformer)
- If the 24VDC Bi-colour lamp is driven with normal polarity (plus on middle contact of the lamp) the first mentioned colour will light up, with inverted polarity the second colour will light up



Dimensions [mm]

LED colour	Operating voltage	Operation current	Lumi. intensity	Dom. wavelength	Part No.	Weight
 <p><b>Single-LED</b></p>						
red	6 VDC +10 %	15 mA ±15 %	350 mcd	630 nm	<b>10-2J06.3142</b>	0.002 kg
	12 VAC/DC +10 %	7/14 mA ±15 %	330 mcd	630 nm	<b>10-2J09.1062</b>	0.002 kg
	24 VAC/DC +10 %	7/14 mA ±15 %	330 mcd	630 nm	<b>10-2J12.1062</b>	0.002 kg
	28 VAC/DC +10 %	7/14 mA ±15 %	330 mcd	630 nm	<b>10-2J13.1062</b>	0.002 kg
	48 VAC/DC +10 %	4/8 mA ±15 %	200 mcd	630 nm	<b>10-2J19.1042</b>	0.002 kg
yellow	6 VDC +10 %	15 mA ±15 %	300 mcd	587 nm	<b>10-2J06.3144</b>	0.002 kg
	12 VAC/DC +10 %	7/14 mA ±15 %	280 mcd	587 nm	<b>10-2J09.1064</b>	0.002 kg
	24 VAC/DC +10 %	7/14 mA ±15 %	280 mcd	587 nm	<b>10-2J12.1064</b>	0.002 kg
	28 VAC/DC +10 %	7/14 mA ±15 %	280 mcd	587 nm	<b>10-2J13.1064</b>	0.002 kg
	48 VAC/DC +10 %	4/8 mA ±15 %	180 mcd	587 nm	<b>10-2J19.1044</b>	0.002 kg
green	6 VDC +10 %	7 mA ±15 %	1050 mcd	525 nm	<b>10-2J06.3145</b>	0.002 kg
	12 VAC/DC +10 %	4/7 mA ±15 %	1050 mcd	525 nm	<b>10-2J09.1065</b>	0.002 kg
	24 VAC/DC +10 %	4/7 mA ±15 %	1050 mcd	525 nm	<b>10-2J12.1065</b>	0.002 kg
	28 VAC/DC +10 %	4/7 mA ±15 %	1050 mcd	525 nm	<b>10-2J13.1065</b>	0.002 kg
	48 VAC/DC +10 %	2/4 mA ±15 %	600 mcd	525 nm	<b>10-2J19.1045</b>	0.002 kg
blue	6 VDC +10 %	15 mA ±15 %	680 mcd	470 nm	<b>10-2J06.3146</b>	0.002 kg
	12 VAC/DC +10 %	7/14 mA ±15 %	650 mcd	470 nm	<b>10-2J09.1066</b>	0.002 kg
	24 VAC/DC +10 %	7/14 mA ±15 %	650 mcd	470 nm	<b>10-2J12.1066</b>	0.002 kg
	28 VAC/DC +10 %	7/14 mA ±15 %	650 mcd	470 nm	<b>10-2J13.1066</b>	0.002 kg
	48 VAC/DC +10 %	4/8 mA ±15 %	400 mcd	470 nm	<b>10-2J19.1046</b>	0.002 kg

# 51 Accessories

LED colour	Operating voltage	Operation current	Lumi. intensity	Dom. wavelength	Part No.	Weight
white	6 VDC +10 %	6 mA ±15 %	900 mcd	x0.31/y0.32 nm	<b>10-2J06.3149</b>	0.002 kg
	12 VAC/DC +10 %	3/6 mA ±15 %	900 mcd	x0.31/y0.32 nm	<b>10-2J09.1069</b>	0.002 kg
	24 VAC/DC +10 %	2.5/5 mA ±15 %	750 mcd	x0.31/y0.32 nm	<b>10-2J12.1069</b>	0.002 kg
	28 VAC/DC +10 %	2.5/5 mA ±15 %	750 mcd	x0.31/y0.32 nm	<b>10-2J13.1069</b>	0.002 kg
	48 VAC/DC +10 %	4/8 mA ±15 %	400 mcd	x0.31/y0.32 nm	<b>10-2J19.1049</b>	0.002 kg
 <p><b>Bi-colour LED</b></p>						
red/green	24 VDC +10 %DC	15/14mA ±15 %	600/630 mcd	625/525 nm	<b>10-A312.314A</b>	0.002 kg

## Filament lamp, T1 3/4 MG

Operating voltage	Operation current	Part No.	Weight
 <p><b>Filament lamp</b></p>			
6 VAC/DC	120 mA ±10 %	<b>10-1306.1349</b>	0.001 kg
6.3 VAC/DC	200 mA ±10 %	<b>10-1307.1369</b>	0.001 kg
12 VAC/DC	75 mA ±10 %	<b>10-1309.1309</b>	0.001 kg
14 VAC/DC	80 mA ±10 %	<b>10-1310.1319</b>	0.001 kg
18 VAC/DC	40 mA ±10 %	<b>10-1311.1249</b>	0.001 kg
24 VAC/DC	35 mA ±10 %	<b>10-1312.1229</b>	0.001 kg
28 VAC/DC	30 mA ±10 %	<b>10-1313.1209</b>	0.001 kg
	40 mA ±10 %	<b>10-1313.1249</b>	0.001 kg
36 VAC/DC	20 mA ±10 %	<b>10-1316.1179</b>	0.001 kg
	30 mA ±10 %	<b>10-1316.1209</b>	0.001 kg
48 VAC/DC	20 mA ±10 %	<b>10-1319.1179</b>	0.001 kg
	25 mA ±10 %	<b>10-1319.1199</b>	0.001 kg

**Series resistor**

**Additional Information**

- Only for filament lamp 48 VAC, 25 mA
- For lamp voltage reduction
- Keep to the country specific safety instructions
- Due to high surface temperatures, the series resistors must be soldered directly to the terminals of the equipment (use a terminal plate)

Operating voltage	Resistance	Part No.	Weight
 <p><b>Series resistor</b></p>			
110 VAC	2.7 kOhm	<b>02-904.0</b>	0.003 kg
125 VAC	3.3 kOhm	<b>02-904.1</b>	0.003 kg
145 VAC	4.7 kOhm	<b>02-904.3</b>	0.003 kg
240 VAC	10 kOhm	<b>02-904.7</b>	0.003 kg

**Terminal plate empty**

**Additional Information**

- For fitting with series resistors



Product attribute	Dimension	Part No.	Weight
 <p><b>Terminal plate empty</b></p>			
5 spaces	62.5 x 60 x 15 mm	<b>02-912.1</b>	0.025 kg
10 spaces	125 x 60 x 15 mm	<b>02-912.2</b>	0.045 kg
15 spaces	187.6 x 60 x 15 mm	<b>02-912.3</b>	0.090 kg
20 spaces	250 x 60 x 15 mm	<b>02-912.4</b>	0.095 kg

## Mounting

### Fixing nut

#### Additional Information

- Special recommended for keylock switches

Material	Part No.	Weight
 <p><b>Fixing nut</b></p>		
Metal	<b>31-991</b>	0.005 kg
 <p><b>Fixing nut</b></p>		
Plastic	<b>51-991</b>	0.005 kg



### Anti-twist ring

#### Additional Information

- For key lock- and selector switch

Part No.	Weight
 <p><b>Anti-twist ring</b></p>	
<b>51-910</b>	0.001 kg

### Lens remover

Product attribute	Part No.	Weight
 <p><b>Lens remover</b></p>		
for raised design	<b>02-905</b>	0.011 kg
 <p><b>Lens remover</b></p>		
for flush design	<b>61-9730.0</b>	0.011 kg

**Lamp remover**

**Additional Information**

▲ **Caution:** A switching process might be released when replacing the lamp

Part No.	Weight
 <p><b>Lamp remover</b></p>	
61-9740.0	0.003 kg

**Mounting tool**

Product attribute	Part No.	Weight
 <p><b>Mounting tool</b></p>		
for tightening or loosening of the fixing nut	<b>01-907</b>	0.020 kg

**Dismantling tool**

**Additional Information**

- For dismantling of lens, lens holder and switching element block

Part No.	Weight
 <p><b>Dismantling tool</b></p>	
51-938	0.027 kg





**Actuator with snap-action switching element block (Keylock- and Selector switch 3 positions)**
**Switching system**

Self-cleaning, double-break snap action switching system  
1 normally closed and 1 normally open contact per element.

**Material**

**Material of contact**  
Gold plated hardsilver

**Switch housing**  
Diallylphthalate (DAP), heat-resistant and self-extinguishing

**Actuator housing**  
Polyetherimide, self-extinguishing

**Mechanical characteristics**

**Terminals**  
Soldering terminal which can also be used as plug-in terminal  
2.8 x 0.5mm:  
Max. wire diameter 2 wires of 1 mm  
Max. wire cross-section of stranded cable 2 x 0.75 mm<sup>2</sup>

**Tightening torque**  
for fixing nut max. 50Ncm

**Actuating torque**  
2.5Ncm...5.5Ncm, depending on the number of switching elements. Measured at the key or lever of the keylock- or selector switch.

**Actuating travel**  
Keylock-/selector switch actuator with 3 positions  
2 x ca. 42° deflection momentary action  
2 x ca. 90° deflection maintained action

**Rebound time**  
≤ 5 ms

**Mechanical lifetime**  
Keylock switch 50 000 cycles of operation  
Selector switch 100 000 cycles of operation

**Electrical characteristics**

**Electrostatic discharge (ESD)**  
≤ 15KV (Keylock switch)

**Conventional free air thermal current**  
5A  
The maximum current in continuous operation and at ambient temperature not exceeding the quoted maximum values.

**Switch rating**  
250VAC, 5A (cosφ 0.75)

**Electric strength**  
2500VAC, 50Hz, 1 min. between all terminals and earth, as per IEC 60512-2-11

**Protection class**  
II

**Environmental conditions**

**Storage temperature**  
-40°C...+85°C

**Service temperature**  
-25°C...+55°C  
for selector switches mounted as a block, make sure the heat can escape freely

**Protection degree**  
Front side, as per IEC 60529  
IP 65 keylock switch  
IP 40 selector switch

**Approvals**

**Approbations**  
CB (IEC 61058)  
CSA  
CQC  
ENEC (EN 61058)  
Germanischer Lloyd  
UL

**Declaration of conformity**  
CE

## Actuator with low level switching element

### Switching system

This low level switching element was designed for switching low powers in electronic circuits. The mechanism assures reliable switching of loads ranging from a few  $\mu\text{A}/\mu\text{V}$  up to 100 mA/42 VAC/DC.

Single-break momentary contact, as normally open or normally closed with 4 independent points of contact. 2 momentary contacts per switching element; combination of normally open and normally closed is possible.

Special features are the long life, extremely short rebound time and stable contact resistance.

### Material

#### Material of contact

Gold plated

#### Switch housing

Polysulfone, heat-resistant and self-extinguishing

#### Actuator housing

Polyetherimide, self-extinguishing

### Mechanical characteristics

#### Terminals

The universal terminals permit these units to be mounted on printed circuit boards (PCB). These terminals can also be used as soldering or plug-in terminals.

For these terminals we can also supply a plug-in base which, when soldered on to the board, enables the switch to be plugged in.

Soldering terminal:

Max. wire diameter 2 wires  $\leq 0.8\text{mm}$

Max. wire cross-section of stranded cable  $1 \times 0.75\text{mm}^2$

Plug-in terminal  $2.0 \times 0.5\text{mm}$

#### Tightening torque

for fixing nut max. 50 Ncm

#### Actuating torque

2.5 Ncm ... 5.5 Ncm, measured at the key or lever of the keylock- or selector switch

#### Actuating force

3 N ... 3.5 N

### Actuating travel

Illuminated pushbutton 3 mm

Keylock-/selector switch actuator 2 positions:

1 x ca.  $42^\circ$  deflection momentary action

1 x ca.  $90^\circ$  deflection maintained action

### Rebound time

Typ.  $< 100\mu\text{s}$

### Mechanical lifetime

Momentary action 5 million cycles of operation

Maintained action 1 million cycles of operation

Keylock switch 50 000 cycles of operation

### Electrical characteristics

#### Contact resistance

Starting value (initial)  $\leq 50\text{m}\Omega$

#### Electrostatic breakdown value

$\leq 15\text{KV}$  (Keylock switch)

#### Switch rating

$10\mu\text{A}$ ,  $100\mu\text{V}$  to 100 mA at 42 VAC/VDC

#### Electric strength

2500 VAC, 50 Hz, 1 min. between all terminals and earth, as per IEC 60512-2-11

### Environmental conditions

#### Storage temperature

$-40^\circ\text{C} \dots +85^\circ\text{C}$

#### Service temperature

$-25^\circ\text{C} \dots +55^\circ\text{C}$

For indicators and illuminated pushbuttons mounted as a block, make sure the heat can escape freely.

#### Protection degree

IP 65 front side, as per IEC 60529

#### Shock resistance

(Single impacts, semi-sinusoidal)

15 g for 11 ms, as per IEC 60512-4-3, IEC 60068-2-27

**Actuator with snap-action switching element**
**Switching system**

Self-cleaning, double-break snap action switching system (with contact gap  $2 \times 0.5$  mm).  
 1 normally closed and 1 normally open contact per element.  
 Snap-action switching elements with soldering terminals at the sides: up to 4 switching element can be on a pushbutton (max. 4 normally closed and 4 normally open contacts).  
 Snap-action switching element with axial plug-in terminals 2.8 mm is not stackable, only 1 switching element can be on a pushbutton.

**Material**
**Material of contact**

Gold plated silver

**Switch housing**

Axial soldering-/plug-in terminal 2.8 mm:  
 Diallylphthalate DAP, Polyamide 66, Polysulfone, heat-resistant and self-extinguishing.

Soldering terminal: PA 6.6 Ultramid

**Actuator housing**

Polyetherimide, self-extinguishing

**Mechanical characteristics**
**Terminals**

Snap-action switching element with tinned soldering terminals at the sides:

Max. wire diameter 2 wires à 1.2 mm

Max. wire cross-section of stranded cable  $1 \times 1$  mm<sup>2</sup>

Snap-action switching element with axial soldering terminals, which can also be used as plug-in terminals  $2.8 \times 0.5$  mm:

Max. wire diameter 2 wires of 1 mm

Max. wire cross-section of stranded cable 2 of 0.75 mm<sup>2</sup> or  $1 \times 1.0$  mm<sup>2</sup>

**Tightening torque**

for fixing nut max. 50 Ncm

**Actuating torque**

2.5 Ncm ... 5.5 Ncm, depending on the number of switching elements. Measured at the key or lever of the keylock- or selector switch.

**Actuating force**

4 N ... 6 N, depending on the number of switching elements

**Actuating travel**

Illuminated pushbutton 3 mm

Keylock-/selector switch actuator 2 positions:

1 x ca. 42° deflection momentary action

1 x ca. 90° deflection maintained action

**Rebound time**

≤ 5 ms

**Mechanical lifetime**

Momentary action 2 million cycles of operation

Maintained action 1 million cycles of operation

Keylock switch 50 000 cycles of operation

**Electrical characteristics**
**Standards**

IEC 61058, EN 61058

**Rated voltage**

250 VAC/VDC

**Rated current**

5 A

**Contact resistance**

Starting value (initial) ≤ 50 mΩ

**Electrostatic discharge (ESD)**

≤ 15 kV (Keylock switch)

**Conventional free air thermal current**

5 A

The maximum current in continuous operation and at ambient temperature not exceeding the quoted maximum values.

**Switch rating**

250 VAC, 5 A (cos φ 1)

250 VAC, 3 A (cos φ 0.3)

Switch rating AC (cos φ 0.7)

Voltage 125 VAC 250 VAC

Current 3 A 2 A

Switch rating DC (inductive) L: R = 30 ms

Voltage 24 VDC 60 VDC 110 VDC 220 VDC

Current 2 A 0.7 A 0.2 A 0.1 A

**Electric strength**

2500 VAC, 50 Hz, 1 min. between all terminals and earth, as per IEC 60512-2-11

**Protection class**

II

**Environmental conditions**
**Storage temperature**

-40 °C ... +85 °C

**Service temperature**

-25 °C ... +55 °C

For indicators and illuminated pushbuttons mounted as a block, make sure the heat can escape freely.

**Protection degree**

IP 65 front side, as per IEC 60529

## Shock resistance

(Single impacts, semi-sinusoidal)  
15 g for 11 ms, as per IEC 60512-4-3, IEC 60068-2-27

## Vibration resistance

(Sinusoidal)  
10 g at 10 Hz ... 1500 Hz, amplitude 0.75 mm,  
as per IEC 60512-4-4, IEC 60068-2-6

## Climate resistance

Standard condition, as per IEC 60068-2-3 and 2-30  
Changing condition, as per IEC 60068-2-14 and 2-33

## Approvals

### Approbations

CB (IEC 61058)  
CSA  
ENEC (EN 61058)  
Germanischer Lloyd  
UL

### Declaration of conformity

CE

## Stop Switch

### Switching system

#### Switching element SE16 with solder terminal

Self-cleaning, double-break snap-action switching system  
1 NC contact and 1 NO contact per switching element.  
Available with up to two switching elements (2 NC contact and 2 NO contact)

#### Switching element SE 2.8mm with solder-/ plug-in terminal

Self-cleaning, double-break snap-action switching system  
(1 NC contact and 1 NO contact)

#### Low-level switching element with universal terminal

Single-break momentary contact switch system. Two contacts  
per switching element with a combination of NC and NO contacts

## Material

### Actuator housing

Polyamide (PA66), Thermoplastic elastomer (TPE)

### Lens

Polyamide (PA6)

### Actuator

Polybutylene Terephthalate (PBT)

### Label

R-640 polyester

### Switching element

Solder terminal	Polyamide (PA 6.6)
Solder-/plug-in interterminal	Diallyl Phthalate (DAP), Polyamide (PA), Polysulfone (PSU)
Universal terminal	Polysulfone (PSU)

### Contact material

Snap action solder terminal	gold-plated silver
Snap action plug-in/solder terminal	gold-plated silver
Low level plug-in/solder/PCB terminal	gold-plated

## Mechanical characteristics

### Terminals

Solder or solder/plug terminal, 2.8 × 0.5 mm  
Universal terminal with 2.0 × 0.5 mm plug-in/solder  
and PCB terminal

### Tightening torque

for fixing nut max. 50 Ncm

### Actuating force

4 ... 6 N (depending on the switching element)

### Mechanical lifetime

100 000 cycles of operation

## Electrical characteristics

### Switch rating

Solder terminal	min. 5 VAC/DC, 1 mA max. 250 VAC/DC, 5 A
Solder-/plug-in terminal	min. 5 VAC/DC, 1 mA max. 250 VAC/DC, 5 A
Universal terminal	min. 100 μV/10 μA max. 42 VAC/DC, 100 mA

## Environmental conditions

### Storage temperature

-40 °C ... +85 °C

### Operating temperature

-25 °C ... +55 °C

### Degree of front protection

IP 65

## Approvals

### Approbations

UL  
CSA  
CB  
ENEC (EN 61058)

### Declaration of conformity

CE

Approvals are not valid for Stop switches with Low-Level switching element.

*EAO reserves the right to alter specifications without further notice.*

## General notes

### 1. Engraving

In addition to the most commonly used world languages, in DIN1451-3 close spacing, other typefaces are available as Scandinavian, Slavic, Greek, Russian and Polish. Red, blue and black lenses are filled with white colour. Other colour lenses are filled in black. Standard height of letters is 2mm. If the height is not specified, we will supply 2mm engraved letters.

### 2. Hot stamping

For larger series it is worth considering markings by means of hot stamping. We will be pleased to advise you. For letters and figures, typefaces with 2.5mm, 3mm and 4mm are available.

### 3. Film inserts

Instead of using engraving the lenses can be fitted with transparent film inserts, as an alternative. For this purpose, though, it is advisable to use transparent lenses. In the case of use of a smoke-black lens the fitted film becomes readable only if the lamp is on. The film thickness is 0.2mm. Important : Consider push-button mounting orientation before specifying engraving characters!

## Lenses for indicators and illuminated pushbuttons, raised mounting

All dimensions in mm

Front size (Lens)	Film insert max. size	Height of letters h	Number of lines	Number of capital letters per line (target value)	Number of small letters per line (target value)	Image
18 x 18 (15.3 x 15.3)	12.7 x 12.7	2	4	7-8	8	B3
		3	3	6-7	7	B3
		4	2	4-5	5	B3
		5	2	3-4	4	B3
		6	1	3	3-4	B3
		8	1	2-3	2-3	B3
18 x 24 (15.3 x 21.5)	12.7 x 18.7	2	4	11	12	B1
			5	7-8	8	B2
		3	3	9-10	10-11	B1
			4	6-7	7	B2
		4	2	7	7-8	B1
			3	4-5	5	B2
		5	2	5-6	6	B1
				3-4	4	B2
		6	1	4-5	5	B1
				3	3-4	B2
		8	1	3-4	3-4	B1
				2-3	2-3	B2
Ø 18 (Ø 15.8)	Ø 12.8	2	3	6	6	B4
		3	2	5	6	B4
		4	2	3	4	B4
		5	1	2	3	B4
		6	1	2	2	B4
		8	1	2	2	B4



# 51 Marking

## Lenses for indicators and illuminated pushbuttons, flush mounting

All dimensions in mm

Front size (Lens)	Film insert max. size	Height of letters h	Number of lines	Number of capital letters per line (target value)	Number of small letters per line (target value)	Image
24 x 24 (18 x 18)	15.1 x 15.1	2	4	8-9	9	B3
		3	3	7-8	8	B3
		4	2	4-5	5	B3
		5	2	4	4-5	B3
		6	1	4	4	B3
		8	1	2-3	2-3	B3
24 x 30 (18 x 24)	15.1 x 21	2	4	12	13	B1
			5	8-9	9	B2
		3	3	10-11	11-12	B1
			4	7-8	8	B2
		4	2	7	8	B1
			3	4-5	5	B2
		5	2	5-6	6	B1
				4	4-5	B2
		6	1	4-5	5	B1
			2	3	3-4	B2
		8	1	3-4	3-4	B1
				2-3	2-3	B2
Ø 25 (Ø 19.7)	Marking plate	2	3	6	6	B4
		3	2	5	6	B4
		4	2	3	4	B4
		5	1	2	3	B4
		6	1	2	3	B4
		8	1	2	2	B4



## Suppressor circuits

When switching inductive loads such as relays, DC motors, and DC solenoids, it is always important to absorb surges (e.g. with a diode) to protect the contacts. When these inductive loads are switched off, a counter emf can severely damage switch contacts and greatly shorten lifetime.

Fig. 1 shows an inductive load with a free-wheeling diode connected in parallel. This free-wheeling diode provides a path for the inductor current to flow when the current is interrupted by the switch. Without this free-wheeling diode, the voltage across the coil will be limited only by dielectric breakdown voltages of the circuit or parasitic elements of the coil. This voltage can be kilovolts in amplitude even when nominal circuit voltages are low (e.g. 12VDC) see Fig. 2.

The free-wheeling diode should be chosen so that the reverse breakdown voltage is greater than the voltage driving the inductive load. The DC blocking voltage ( $V_R$ ) of the free-wheeling diode can be found in the datasheet of a diode. The forward current should be equal or greater than the maximum current flowing through the load.

**To get an efficient protection, the free-wheeling diode must be connected as close as possible to the inductive load!**

Switching with inductive load  
Fig. 1



Counter EMF  
over load without free-wheeling diode  
Fig. 2



## Index from Part No.

Part No.	Page	Part No.	Page	Part No.	Page	Part No.	Page	Part No.	Page	Part No.	Page
01-907	75	51-051.006F	4	51-153.0265	39	51-255.025D2F	15	51-338.025D2	43	51-412.036DF	17
01-928	70	51-051.006F	7	51-153.0266	40	51-256.025	37	51-338.025D2F	47	51-414.036D	43
01-929	70	51-051.006F	8	51-153.0268	40	51-256.0250	38	51-355.022D	41	51-414.036DF	17
02-904.0	73	51-121.022	34	51-154.0252	34	51-256.0254	37	51-355.022DF	16	51-415.036D	43
02-904.1	73	51-121.0252	34	51-154.0252F	5	51-256.0255	37	51-355.025D2	41	51-415.036DF	17
02-904.3	73	51-122.0252	34	51-154.0252F	9	51-256.0256	38	51-355.025D2F	15	51-417.036DF	17
02-904.7	73	51-123.0252	34	51-154.0252F	11	51-256.0258	38	51-356.025D2	42	51-418.036D	43
02-905	74	51-124.0252	34	51-154.0252F	13	51-256.025D2	42	51-356.025D2F	16	51-418.036DF	17
02-912.1	73	51-131.022	34	51-155.022D	42	51-256.025D2F	16	51-357.025D2F	16	51-421.036	34
02-912.2	73	51-131.0252	34	51-155.022DF	16	51-256.026	37	51-358.025D2	42	51-422.036	34
02-912.3	73	51-132.0252	35	51-155.025D2	41	51-256.0260	38	51-358.025D2F	16	51-422.036	34
02-912.4	73	51-133.0252	35	51-155.025D2F	15	51-256.0264	37	51-361.022D	45	51-425.036	34
10-1306.1349	72	51-134.0252	35	51-156.0250	40	51-256.0265	37	51-361.022DF	20	51-426.036	34
10-1307.1369	72	51-135.022D	43	51-156.0252	39	51-256.0266	38	51-362.022D	45	51-427.036D	42
10-1309.1309	72	51-135.022DF	17	51-156.0254	39	51-256.0268	38	51-362.022DF	20	51-427.036DF	16
10-1310.1319	72	51-135.025D2	43	51-156.0255	39	51-257.025D2	42	51-363.022D	45	51-428.036D	42
10-1311.1249	72	51-135.025D2F	17	51-156.0256	40	51-257.025D2F	16	51-363.022DF	20	51-428.036DF	16
10-1312.1229	72	51-136.025D2	43	51-156.0258	40	51-258.025D2	42	51-364.022D	45	51-431.036	34
10-1313.1209	72	51-136.025D2F	17	51-156.025D2	42	51-258.025D2F	16	51-364.022DF	20	51-433.036	34
10-1313.1249	72	51-137.025D2	43	51-156.025D2F	16	51-259.025	37	51-365.022D	45	51-435.036	34
10-1316.1179	72	51-137.025D2F	17	51-156.0260	40	51-259.0250	38	51-365.022DF	20	51-436.036	34
10-1316.1209	72	51-138.025D2	43	51-156.0262	39	51-259.0254	37	51-366.022D	45	51-437.036DF	17
10-1319.1179	72	51-138.025D2F	17	51-156.0264	39	51-259.0255	37	51-366.022DF	20	51-443.036D	43
10-1319.1199	72	51-141.022D	43	51-156.0265	39	51-259.0256	38	51-367.022DF	20	51-438.036DF	17
10-2J06.3142	71	51-141.022DF	17	51-156.0266	40	51-259.0258	38	51-368.022DF	20	51-441.036D	41
10-2J06.3144	71	51-141.025D2	43	51-156.0268	40	51-261.022	34	51-371.022D	46	51-441.036DF	15
10-2J06.3145	71	51-141.025D2F	17	51-157.025D2	42	51-261.0252	34	51-371.022DF	20	51-441.036DF	41
10-2J06.3146	71	51-142.025D2	43	51-157.025D2F	16	51-262.0252	34	51-372.022D	46	51-442.036DF	15
10-2J06.3149	72	51-142.025D2F	17	51-158.025D2	42	51-263.0252	34	51-372.022DF	20	51-444.036D	41
10-2J09.1062	71	51-143.025D2	43	51-158.025D2F	16	51-264.0252	34	51-373.022D	46	51-444.036DF	15
10-2J09.1064	71	51-143.025D2F	17	51-159.0250	40	51-271.022	34	51-373.022DF	20	51-445.036D	41
10-2J09.1065	71	51-144.025D2	43	51-159.0252	39	51-271.0252	34	51-374.022D	46	51-445.036DF	15
10-2J09.1066	71	51-144.025D2F	17	51-159.0254	39	51-272.0252	35	51-374.022DF	20	51-447.036DF	15
10-2J09.1069	72	51-145.022D	41	51-159.0255	39	51-273.0252	35	51-375.022DF	20	51-448.036D	41
10-2J12.1062	71	51-145.022DF	15	51-159.0256	40	51-274.0252	35	51-376.022D	46	51-448.036DF	15
10-2J12.1064	71	51-145.025D2	41	51-159.0258	40	51-281.022	33	51-376.022DF	20	51-451.036	33
10-2J12.1065	71	51-145.025D2F	15	51-195.022D	42	51-281.022F	5	51-377.022D	46	51-451.036F	5
10-2J12.1066	71	51-146.025D2	41	51-195.022DF	16	51-281.022F	9	51-377.022DF	20	51-451.036F	9
10-2J12.1069	72	51-146.025D2F	15	51-195.025D2	42	51-281.022F	11	51-378.022D	46	51-451.036F	11
10-2J13.1062	71	51-147.025D2F	15	51-195.025D2F	16	51-281.022F	13	51-378.022DF	20	51-451.036F	13
10-2J13.1064	71	51-148.025D2	41	51-196.025D2	42	51-281.0252	33	51-381.022D	45	51-452.036	33
10-2J13.1065	71	51-148.025D2F	15	51-196.025D2F	16	51-281.0252F	5	51-381.022DF	19	51-452.036F	5
10-2J13.1066	71	51-151.022	33	51-197.025D2	42	51-281.0252F	9	51-382.022D	45	51-452.036F	9
10-2J13.1069	72	51-151.022F	5	51-197.025D2F	16	51-281.0252F	11	51-382.022DF	19	51-452.036F	11
10-2J19.1042	71	51-151.022F	9	51-198.025D2	42	51-281.0252F	13	51-383.022DF	19	51-452.036F	13
10-2J19.1044	71	51-151.022F	11	51-198.025D2F	16	51-282.0252	33	51-384.022D	45	51-453.036	33
10-2J19.1045	71	51-151.022F	13	51-235.022D	43	51-282.0252F	5	51-384.022DF	19	51-453.036F	5
10-2J19.1046	71	51-151.0252	33	51-235.022DF	17	51-282.0252F	9	51-385.022D	45	51-453.036F	9
10-2J19.1049	72	51-151.0252F	5	51-235.025D2	43	51-282.0252F	11	51-385.022DF	19	51-453.036F	11
10-2J19.1049	72	51-151.0252F	9	51-235.025D2F	17	51-282.0252F	13	51-386.022DF	19	51-453.036F	13
10-A312.314A	72	51-151.0252F	11	51-236.025D2	43	51-283.0252	34	51-387.022DF	19	51-455.036	33
31-928	70	51-151.0252F	13	51-236.025D2F	17	51-283.0252F	5	51-388.022D	45	51-455.036F	5
31-929	70	51-152.0252	33	51-237.025D2	43	51-283.0252F	9	51-388.022DF	19	51-455.036F	9
31-940	68	51-152.0252F	5	51-237.025D2F	17	51-283.0252F	11	51-395.022D	42	51-455.036F	11
31-941	68	51-152.0252F	9	51-238.025D2	43	51-283.0252F	13	51-395.022DF	16	51-455.036F	13
31-942	68	51-152.0252F	11	51-238.025D2F	17	51-284.0252	34	51-395.025D2	42	51-456.036F	5
31-945	69	51-152.0252F	13	51-252.026	37	51-284.0252F	5	51-395.025D2F	16	51-456.036F	9
31-946	69	51-152.0260	40	51-252.0260	38	51-284.0252F	9	51-396.025D2	42	51-456.036F	11
31-985.0	67	51-152.0262	39	51-252.0264	37	51-284.0252F	11	51-396.025D2F	16	51-456.036F	13
31-989.300	66	51-152.0264	39	51-252.0265	37	51-284.0252F	13	51-397.025D2	42	51-457.036D	41
31-989.311	67	51-152.0265	39	51-252.0266	38	51-295.022D	42	51-397.025D2F	16	51-457.036DF	15
31-991	74	51-152.0266	40	51-252.0268	38	51-295.022DF	16	51-398.025D2F	16	51-458.036D	41
51-030.002	32	51-152.0268	40	51-253.022	37	51-295.025D2	42	51-401.036D	42	51-458.036DF	15
51-030.005	32	51-153.0220	40	51-253.0220	38	51-295.025D2F	16	51-401.036DF	16	51-461.036	34
51-031.006	32	51-153.0222	39	51-253.0224	37	51-296.025D2	42	51-402.036D	42	51-463.036	34
51-040.002	31	51-153.0224	39	51-253.0225	37	51-296.025D2F	16	51-402.036DF	16	51-465.036	34
51-040.005	31	51-153.0225	39	51-253.0226	38	51-297.025D2	42	51-404.036D	42	51-471.036	34
51-041.006	31	51-153.0226	40	51-253.0228	38	51-297.025D2F	16	51-404.036DF	16	51-473.036	34
51-050.002	31	51-153.0228	40	51-253.026	37	51-298.025D2	42	51-405.036D	42	51-475.036	34
51-050.002F	4	51-153.0252	34	51-253.0260	38	51-298.025D2F	16	51-405.036DF	16	51-481.036	33
51-050.002F	7	51-153.0252F	5	51-253.0264	37	51-335.022D	43	51-407.036D	42	51-481.036F	5
51-050.002F	8	51-153.0252F	9	51-253.0265	37	51-335.022DF	17	51-407.036DF	16	51-481.036F	9
51-050.005	31	51-153.0252F	11	51-253.0266	38	51-335.025D2	43	51-408.036D	42	51-481.036F	11
51-050.005F	4	51-153.0252F	13	51-253.0268	38	51-335.025D2F	17	51-408.036DF	16	51-481.036F	13
51-050.005F	7	51-153.0260	40	51-255.022D	41	51-336.025D2	43	51-411.036D	43	51-482.036F	5
51-050.005F	8	51-153.0262	39	51-255.022DF	15	51-336.025D2F	17	51-411.036DF	17	51-482.036F	9
51-051.006	31	51-153.0264	39	51-255.025D2	41	51-337.025D2F	17	51-412.036D	43	51-482.036F	11



Part No.	Page	Part No.	Page	Part No.	Page	Part No.	Page	Part No.	Page
51-482.036F	13	51-910	74	52-272.0252	48	61-9028.60	58	61-9927.2	63
51-483.036	33	51-920	65	52-273.0252	22	61-9028.9	58	61-9930.0	60
51-483.036F	5	51-925	65	52-273.0252	25	61-9029.20	58	61-9930.0	62
51-483.036F	9	51-931.0	54	52-273.0252	48	61-9029.30	58	61-9930.4	60
51-483.036F	11	51-931.2	54	52-274.0252	22	61-9029.40	58	61-9930.4	62
51-483.036F	13	51-931.3	54	52-274.0252	25	61-9029.8	58	61-9931.0	60
51-485.036	33	51-931.4	54	52-274.0252	48	61-9029.9	58	61-9931.0	62
51-485.036F	5	51-931.5	54	52-431.036	21	61-9451.0	65	61-9931.4	60
51-485.036F	9	51-931.6	54	52-431.036	24	61-9452.0	65	61-9931.4	62
51-485.036F	11	51-931.8	54	52-431.036	47	61-9453.0	65	61-9932.0	62
51-485.036F	13	51-931.9	54	52-432.036	21	61-9593.0	57	61-9932.0	63
51-486.036	33	51-933.1	54	52-432.036	24	61-9593.2	57	61-9932.1	62
51-486.036F	5	51-933.2	54	52-432.036	47	61-9593.4	57	61-9932.1	63
51-486.036F	9	51-933.3	54	52-433.036	21	61-9593.5	57	61-9932.10	62
51-486.036F	11	51-933.4	54	52-433.036	24	61-9642.1	52	61-9932.10	63
51-486.036F	13	51-933.5	54	52-433.036	47	61-9642.2	52	61-9932.2	62
51-495.022D	42	51-933.6	54	52-435.036	21	61-9642.3	52	61-9932.2	63
51-495.022DF	16	51-933.7	54	52-435.036	24	61-9642.4	52	61-9932.4	62
51-495.025D2	42	51-935.2	54	52-435.036	47	61-9642.5	52	61-9932.4	63
51-495.025D2F	16	51-935.4	54	52-436.036	21	61-9642.6	52	61-9932.5	62
51-496.025D2	42	51-935.5	54	52-436.036	24	61-9642.7	52	61-9932.5	63
51-496.025D2F	16	51-935.7	54	52-436.036	47	61-9643.201	55	61-9932.6	62
51-497.025D2	42	51-938	75	52-471.036	21	61-9643.202	55	61-9932.6	63
51-497.025D2F	16	51-943.0	69	52-471.036	24	61-9643.203	55	61-9933.0	60
51-498.025D2	42	51-943.1	69	52-471.036	47	61-9643.301	55	61-9933.0	61
51-498.025D2F	16	51-947.0	66	52-472.036	21	61-9643.401	55	61-9933.1	60
51-701.006	31	51-948.0	66	52-472.036	24	61-9643.501	55	61-9933.1	61
51-702.006	31	51-949.0	66	52-472.036	47	61-9643.502	55	61-9933.10	60
51-703.006	31	51-951.0	53	52-473.036	21	61-9643.503	55	61-9933.10	61
51-704.006	31	51-951.2	53	52-473.036	24	61-9643.601	55	61-9933.2	60
51-705.0292	34	51-951.3	53	52-473.036	47	61-9643.602	55	61-9933.2	61
51-706.0292	34	51-951.4	53	52-475.036	21	61-9643.603	55	61-9933.4	60
51-707.0292	34	51-951.5	53	52-475.036	24	61-9643.701	55	61-9933.4	61
51-708.0292	34	51-951.6	53	52-475.036	47	61-9643.702	55	61-9933.5	60
51-710.0292	33	51-951.8	53	52-476.036	21	61-9643.703	55	61-9933.5	61
51-712.0292	33	51-951.9	53	52-476.036	24	61-9671.1	52	61-9933.6	60
51-714.0292	34	51-953.1	53	52-476.036	47	61-9671.2	52	61-9933.6	61
51-715.0292	34	51-953.2	53	52-571.022A	27	61-9671.3	52	61-9934.8	61
51-716.0292	34	51-953.3	53	52-571.022A	29	61-9671.4	52	61-9936.0	63
51-718.0292	33	51-953.4	53	52-571.022A	50	61-9671.5	52	61-9980.0	59
51-719.0292	33	51-953.5	53	52-572.022A	27	61-9671.6	52	704.968.0	59
51-720.0292	33	51-953.6	53	52-572.022A	29	61-9671.7	52	704.968.1	59
51-741.006	32	51-953.7	53	52-572.022A	50	61-9681.1	52	84-9103.7	63
51-742.006	32	51-954.2	53	52-573.022A	27	61-9681.2	52		
51-746.0292	34	51-954.3	53	52-573.022A	29	61-9681.3	52		
51-747.0292	34	51-954.4	53	52-573.022A	50	61-9681.4	52		
51-749.0292	34	51-954.5	53	52-574.022A	27	61-9681.5	52		
51-750.0292	34	51-954.6	53	52-574.022A	29	61-9681.6	52		
51-901.0	54	51-954.7	53	52-574.022A	50	61-9681.7	52		
51-901.2	54	51-955.2	53	52-743.0292	47	61-9707.7	55		
51-901.3	54	51-955.4	53	52-744.0292	47	61-9730.0	74		
51-901.4	54	51-955.5	53	52-745.0292	48	61-9740.0	75		
51-901.5	54	51-955.7	53	52-746.0292	48	61-9771.0	52		
51-901.6	54	51-991	74	52-747.0292	48	61-9771.8	52		
51-901.8	54	52-131.022	21	52-748.0292	48	61-9771.9	52		
51-901.9	54	52-131.022	24	52-749.0292	48	61-9781.0	52		
51-903.1	53	52-131.022	47	52-750.0292	48	61-9781.9	52		
51-903.2	53	52-131.0252	21	52-928.0	58	61-9841.0	56		
51-903.3	53	52-131.0252	24	52-928.20	58	61-9841.0A	56		
51-903.4	53	52-131.0252	47	52-928.30	58	61-9841.2	56		
51-903.5	53	52-132.0252	21	52-928.40	58	61-9841.2A	56		
51-903.6	53	52-132.0252	24	52-928.50	58	61-9841.4	56		
51-903.7	53	52-132.0252	48	52-928.60	58	61-9841.4A	56		
51-904.2	54	52-133.0252	21	52-928.9	58	61-9841.5	56		
51-904.3	54	52-133.0252	24	52-929.20	58	61-9841.5A	56		
51-904.4	54	52-133.0252	48	52-929.30	58	61-9841.6	56		
51-904.5	54	52-134.0252	21	52-929.40	58	61-9841.6A	56		
51-904.6	54	52-134.0252	24	52-929.50	58	61-9841.8	56		
51-904.7	54	52-134.0252	48	52-929.60	58	61-9841.8A	56		
51-905.2	54	52-271.022	21	52-929.8	58	61-9842.0	56		
51-905.4	54	52-271.022	24	52-929.9	58	61-9842.2	56		
51-905.5	54	52-271.022	48	52-950.0	57	61-9842.5	56		
51-905.7	54	52-271.0252	21	52-952.0	57	61-9842.6	56		
51-906.2	54	52-271.0252	24	61-9028.0	58	61-9842.8	56		
51-906.4	54	52-271.0252	48	61-9028.20	58	61-9921.0	64		
51-906.5	54	52-272.0252	22	61-9028.40	58	61-9922.0	64		
51-906.7	54	52-272.0252	25	61-9028.50	58	61-9924.0	64		





## Стандарт Электрон Связь

Мы молодая и активно развивающаяся компания в области поставок электронных компонентов. Мы поставляем электронные компоненты отечественного и импортного производства напрямую от производителей и с крупнейших складов мира.

Благодаря сотрудничеству с мировыми поставщиками мы осуществляем комплексные и плановые поставки широчайшего спектра электронных компонентов.

Собственная эффективная логистика и склад в обеспечивает надежную поставку продукции в точно указанные сроки по всей России.

Мы осуществляем техническую поддержку нашим клиентам и предпродажную проверку качества продукции. На все поставляемые продукты мы предоставляем гарантию .

Осуществляем поставки продукции под контролем ВП МО РФ на предприятия военно-промышленного комплекса России , а также работаем в рамках 275 ФЗ с открытием отдельных счетов в уполномоченном банке. Система менеджмента качества компании соответствует требованиям ГОСТ ISO 9001.

Минимальные сроки поставки, гибкие цены, неограниченный ассортимент и индивидуальный подход к клиентам являются основой для выстраивания долгосрочного и эффективного сотрудничества с предприятиями радиоэлектронной промышленности, предприятиями ВПК и научно-исследовательскими институтами России.

С нами вы становитесь еще успешнее!

### Наши контакты:

**Телефон:** +7 812 627 14 35

**Электронная почта:** [sales@st-electron.ru](mailto:sales@st-electron.ru)

**Адрес:** 198099, Санкт-Петербург,  
Промышленная ул, дом № 19, литера Н,  
помещение 100-Н Офис 331