

DATA SHEET

HITAG S

HTS IC H32/HTS IC H56/HTS IC H48
Transponder IC

Product Specification

Revision 3.1

PUBLIC INFORMATION

2006 July 18

079231

HITAG S**HTS IC H32/HTS IC H56/HTS IC H48****CONTENTS**

1	FEATURES	3	9.3	Reset Time	26
1.1	Protocol	3	9.4	HITAG S Transponder waiting time before transmitting a response after receiving an EOF	27
1.2	Memory	3	9.5	HITAG S Transponder programming time	28
1.3	Supported Standards	3	9.6	HITAG S Transponder waiting time before transmitting data in TTF Mode	29
1.4	Security Features	3	9.7	HITAG S Transponder Mode switching time	30
1.5	Delivery Types	3	10	STATE DIAGRAM	31
2	GENERAL DESCRIPTION	4	10.1	General Description of States	31
2.1	Target Markets	4	10.2	HITAG S 32	32
2.1.1	Animal Identification	4	10.3	HITAG S 256 and HITAG S 2048	33
2.1.2	Laundry Automation	4	11	COMMAND SET	34
2.1.3	Beer Keg and Gas Cylinder Logistic	4	11.1	General Comments	34
2.1.4	Pigeon Race Sports	4	11.2	UID REQUEST xx	34
2.1.5	Security Applications	4	11.3	AC SEQUENCE	35
2.1.6	Access Control, Company Cards, Amusement Parks	4	11.4	SELECT (UID)	36
2.2	Customer Application Support and Training	4	11.5	CHALLENGE	37
3	ORDERING INFORMATION	5	11.6	SELECT_QUIET (UID)	38
4	BLOCKDIAGRAM	6	11.7	READ PAGE	38
5	REFERENCE DOCUMENTS	6	11.8	READ BLOCK	39
6	MEMORY ORGANISATION	7	11.9	WRITE PAGE	40
6.1	Unique Identifier (UID)	8	11.10	WRITE BLOCK	41
6.1.1	Product identifier (PID)	8	11.11	QUIET	42
6.2	HITAG S Plain Mode	8	12	TRANSPONDER TALKS FIRST (TTF) MODE	43
6.3	HITAG S Authentication Mode	9	12.1	32 Bit TTF Mode	43
7	FUNCTIONAL DESCRIPTION	10	12.2	64 Bit TTF Mode	43
7.1	Basic System Configuration	10	12.3	128 Bit TTF Mode	44
7.2	Energy Transmission	11	13	DATA INTEGRITY / CALCULATION OF CRC	45
7.3	Data Transmission: Transponder → Read/Write Device	12	13.1	Data Transmission: Read/Write Device to HITAG S Transponder	45
7.3.1	Coding	13	13.2	Data Transmission: HITAG S Transponder to Read/Write Device	45
7.3.2	Data Rate	14	13.2.1	Standard Response Protocol Mode	45
7.4	Data Transmission: Read/Write Device → Transponder (Physical Layer)	15	13.2.2	Advanced/Fast Advanced Response Protocol Mode	45
7.4.1	Coding	15	13.3	Source Code for CRC-Checksum	46
7.4.2	Modulation details	17	14	ABBREVIATIONS	47
8	CONFIGURATION	18	15	DATA SHEET STATUS	48
8.1	Configuration Page	18	16	DEFINITIONS	48
8.2	Delivery Configuration	21	17	DISCLAIMERS	48
8.2.1	HITAG S32	21	18	REVISION HISTORY	50
8.2.2	HITAG S256	22			
8.2.3	HITAG S2048	23			
9	PROTOCOL TIMING	24			
9.1	Read/Write Device waiting time before sending the first command	24			
9.2	Read/Write Device waiting time before sending a subsequent command	25			

HITAG S

HTS IC H32/HTS IC H56/HTS IC H48

1 FEATURES

- Integrated Circuit for Contactless Identification Transponders and Cards
- Integrated resonance capacitor of 210 pF with $\pm 5\%$ tolerance over full production
- Frequency range 100..150 kHz.

1.1 Protocol

- Modulation Read/Write Device → Transponder: 100 % ASK and Binary Pulse Length Coding
- Modulation Transponder → Read/Write Device: Strong ASK modulation with Anticollision, Manchester and Biphase Coding
- Fast Anticollision Protocol for inventory tracking: 100 Tags in 3.2 seconds
- Data integrity check (CRC)
- Optional Transponder Talks First Modes with user defined data length
- Temporary switch from Transponder Talks First into Reader Talks First Mode
- Data Rate Read/Write Device to Transponder: 5.2 kBit/s
- Data Rates Transponder to Read/Write Device: 2 kBit/s, 4 kBit/s, 8 kBit/s

1.2 Memory

- Three memory options (32 Bit UID, 256 Bit, 2048 Bit)
- More than 100000 erase/write cycles
- 10 years non - volatile data retention
- Secure Memory Lock functionality

1.3 Supported Standards

- Full compliant to ISO 11784/85 Animal ID
- Targeted to operated on hardware infrastructure of new upcoming standards
 - ISO14223 (Animal ID with anticollision and read/write functionality)
 - ISO 18000-2 (AIDC Techniques-RFID or Item Management)
- Supports German Waste Management Standard and Pigeon Race Standard

1.4 Security Features

- 32 Bit Unique Identification Number (UID)
- 48 Bit secret key based encrypted authentication

1.5 Delivery Types

- Sawn, gold - bumped 8" Wafer
- Contactless Chip Card Module MOA2
- I – Connect (Low Cost Flip Chip Package)

HITAG S

HTS IC H32/HTS IC H56/HTS IC H48

2 GENERAL DESCRIPTION

The HITAG™ product line is well known and established in the contactless identification market.

Due to the open marketing strategy of Philips Semiconductors there are various manufacturers well established for both the transponders / cards as well as the Read/Write Devices. All of them supporting HITAG 1 and HITAG 2 transponder IC's. With the new HITAG S family, this existing infrastructure is extended with the next generation of IC's being substantially smaller in mechanical size, lower in cost, offering more operation distance and speed, but still being operated with the same reader infrastructure and transponder manufacturing equipment.

One Protocol - three memory options.

The protocol and command structure for HITAG S is based on HITAG 1, including anticollision algorithm.

Three different memory sizes are offered and can be operated using exactly the same protocol.

HITAG S 32	32 Bit Unique Identifier	Read Only
HITAG S 256	256 Bit Total Memory	Read/Write
HITAG S 2048	2048 Bit Total Memory	Read/Write

2.1 Target Markets

2.1.1 ANIMAL IDENTIFICATION

Basically, the animal id market can be divided into two different areas:

a) Identification of pet animals

Some countries require that the your dog/cat is being microchipped prior to immigration. But it is also of advantage in case your pet is getting lost. The microchipped pet gets easily identified with a handheld reader and thus can be distinguished from stray animals.

The ISO standard 11784/85 is well established in this markets and HITAG S 256 and HITAG S 2048 are compliant to this standard, while offering additional memory for storage of customised off line data, such as phone number/address of the pets owner.

b) Identification and Tracking of livestock like cattle, pork and sheep

Being compatible with the ISO 11784/85 reader infrastructure, HITAG S can be switched temporarily into read/write mode, thus enabling additional features, like e.g. off line data storage directly on the animals tag

This concept has already been standardised within ISO 14223/1.

2.1.2 LAUNDRY AUTOMATION

- Identify 200 pcs of garment with one Read/Write Device
- Long operation distance with typical small shaped laundry button transponders
- Insensitive to harsh conditions like pressure, heat and water.

2.1.3 BEER KEG AND GAS CYLINDER LOGISTIC

- Recognising a complete pallet of gas cylinders at one time.
- Long writing distance.
- Voluntarily change between TTF Mode with user defined data length and Read/Write Modes with out changing the configuration on the transponder.
- Authenticity check at the beer pubs- between beer bumper and supplied beer keg, provides a safe protection of the beer brand.

2.1.4 PIGEON RACE SPORTS

According to European pigeon race standards, offering the additional shadow memory, that is required in some European companies.

2.1.5 SECURITY APPLICATIONS

Authenticity check for high level brands or for original refilling e.g. toner for fax machines.

2.1.6 ACCESS CONTROL, COMPANY CARDS, AMUSEMENT PARKS

The included encrypted authentication feature is well suited for applications like access control and vending machines. In particular the combined application with one company card opening the barrier for the car parking, opening the access to the building and rooms with different security levels, offering drinks and coffee from the vending machines in the socialising area.

2.2 Customer Application Support and Training

Within the dedicated CAS team within the BU Identification.

Please Contact:

info.bli@philips.com

Accompanying Data Sheets and Application Notes:

<http://www.semiconductors.com/markets/identification/customer/download/index.html#hitag>

HITAG S

HTS IC H32/HTS IC H56/HTS IC H48

3 ORDERING INFORMATION

EXTENDED TYPE NUMBER	DESCRIPTION	MEMORY SIZE	ORDERING CODE	PACKAGE	TEMPERATURE RANGE (°C)
HTS IC H32 01EW/V4	Sawn 8" wafer on foil (FFC), 150 μm, inked and mapped, with gold bumps	32 Bit	9352 729 70005	–	-25 °C to +85 °C
HTS IC H56 01EW/V4		256 Bit	9352 729 71005	–	
HTS IC H48 01EW/V4		2048 Bit	9352 729 73005	–	
HTS MO H32 01EV	MOA2 Package	32 Bit	9352 729 69118	SOT500AA1	-25 °C to +85 °C
HTS MO H56 01EV		256 Bit	9352 729 72118		
HTS MO H48 01EV		2048 Bit	9352 729 74118		
HTS FC H32 01EV/DH	Flip Chip Package, Hot Laminated	32 Bit	9352 729 75118	SOT732AA1	-25 °C to +85 °C
HTS FC H56 01EV/DH		256 Bit	9352 729 76118		
HTS FC H48 01EV/DH		2048 Bit	9352 729 77118		

HITAG S

HTS IC H32/HTS IC H56/HTS IC H48

4 BLOCKDIAGRAM

The HITAG S Transponder requires no external power supply. The contactless interface generates the power supply and the system clock via the resonant circuitry by inductive coupling to the Read/Write Device (RWD). The interface also demodulates data transmitted from the RWD to the HITAG S Transponder, and modulates the magnetic field for data transmission from the HITAG S Transponder to the RWD.

Data are stored in a non-volatile memory (EEPROM). The EEPROM has a capacity up to 2048 Bit and is organised in 64 Pages consisting of 4 Bytes each (1 Page = 32 Bits).

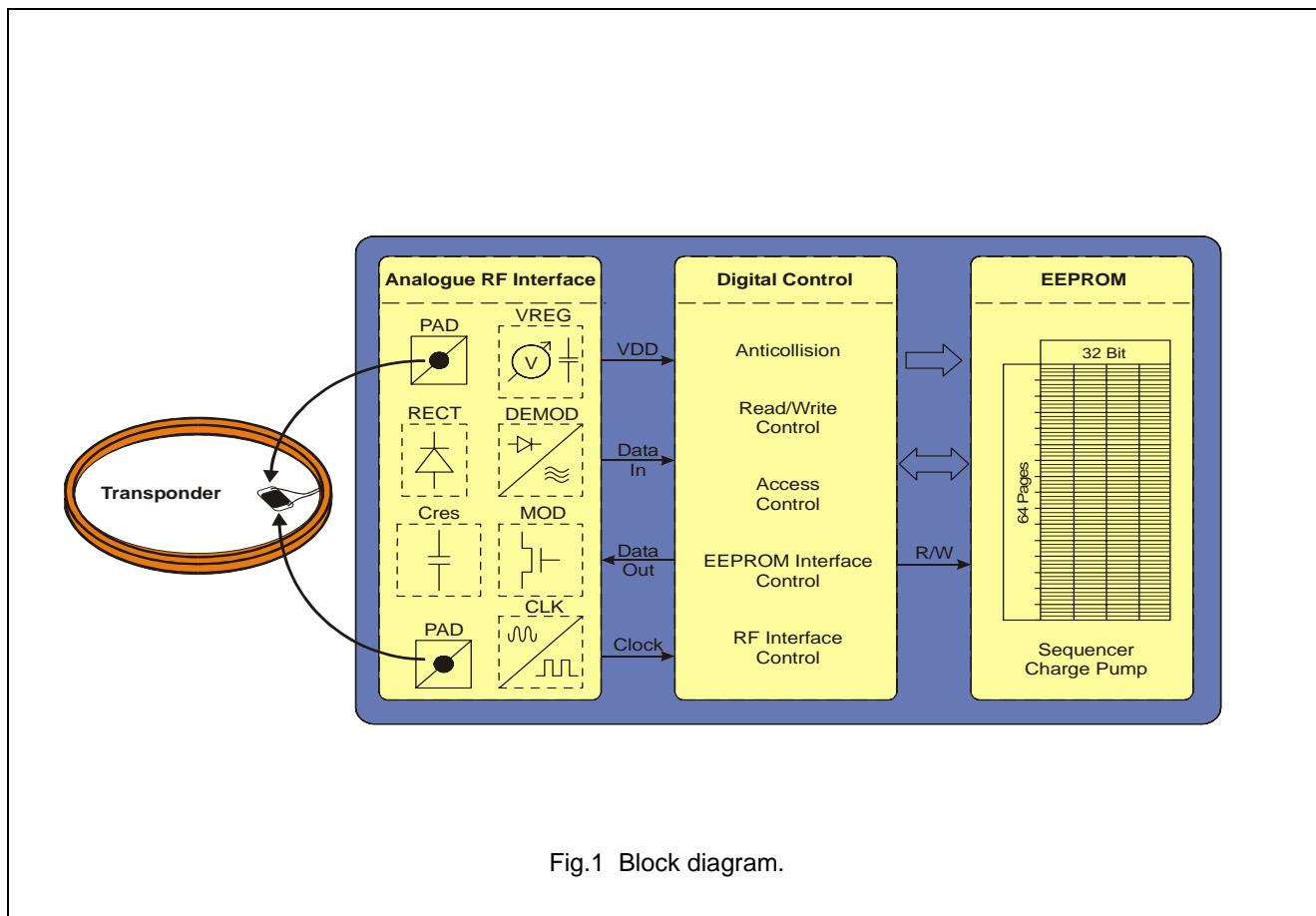

5 REFERENCE DOCUMENTS

- General Quality Specification
- General Specification for 8" Wafer
- Bumped Wafer Specification
- Addendum Bumped Wafer Specification HTS IC H32/ HTS IC H56/ HTS IC H48 (electrical values)
- Contactless Chip Card Module Specification
- Addendum Contactless Chip Card Module Specification HTS MO H32/HTS MO H56/HTS MO H48
- Flip Chip Package Specification
- Addendum Flip Chip Package Specification HTS FC H32/HTS FC H56/HTS FC H48
- Application Note HITAG S Coil Design Guide.

HITAG S

HTS IC H32/HTS IC H56/HTS IC H48

6 MEMORY ORGANISATION

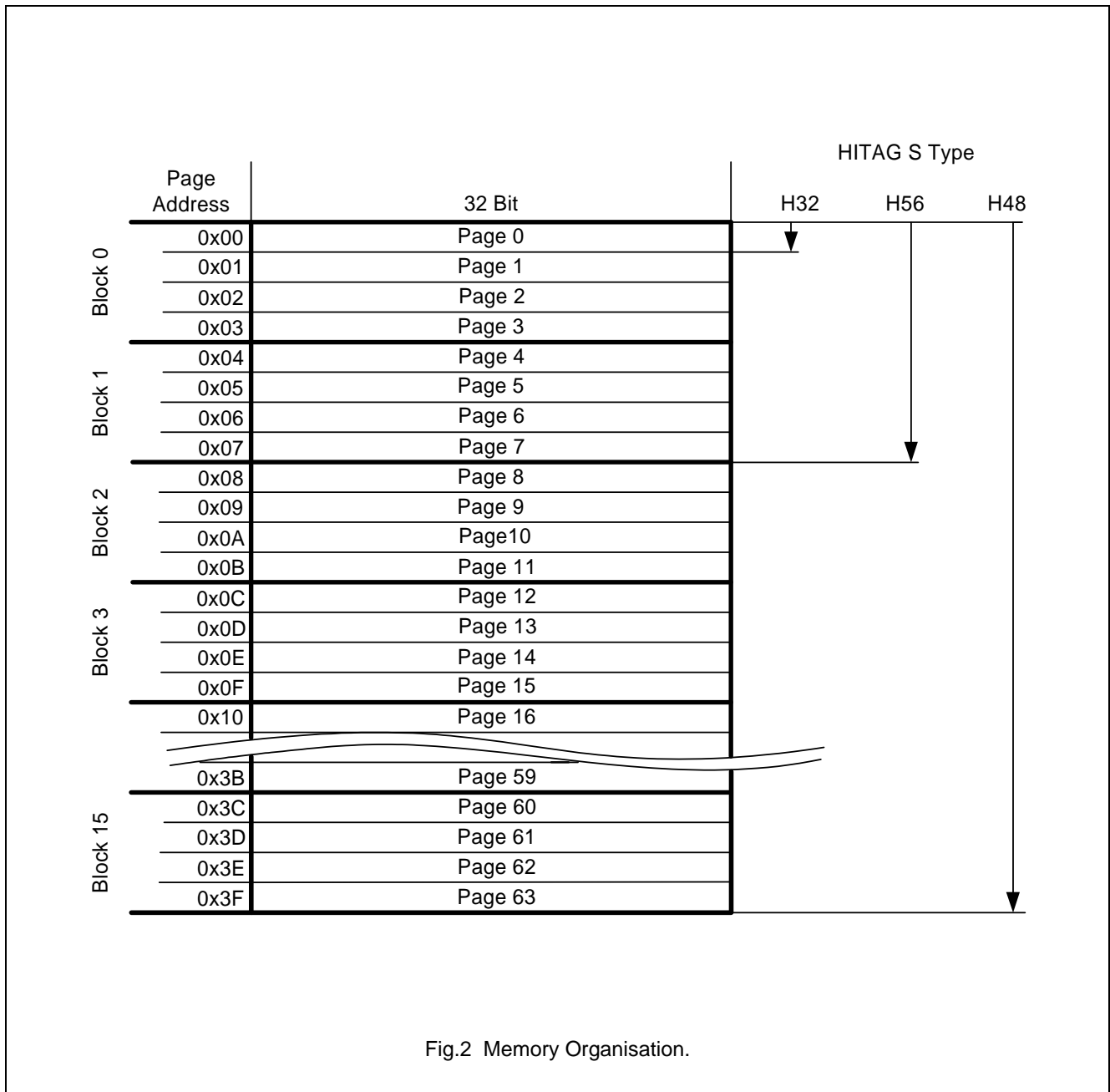

Fig.2 Memory Organisation.

The EEPROM has a capacity up to 2048 Bit and is organised in 16 Blocks, consisting of 4 Pages each, for commands with Block access. A Page consists of 4 Bytes each (1 Page = 32 Bits) and is the smallest access unit.

Addressing is done Page by Page (Page 0 up to 63) and access is gained either Page by Page or Block by Block entering the respective Page start address. In case of Block Read/Write access, the transponder is processed from the start Page address within one block to the end of the corresponding block.

Three different types of HITAG S IC's with different memory sizes as shown in the figure above are available.

HITAG S

HTS IC H32/HTS IC H56/HTS IC H48

6.1 Unique Identifier (UID)

Page 0 contains the 32 Bit Unique Identifier (UID) which is programmed during the manufacturing process.
 Page 0 access: Read Only (RO)

Page Address	MSByte				LSByte			
	MSB	LSB	MSB	LSB	MSB	LSB	MSB	LSB
0x00	UID 3		UID 2		UID 1		UID 0	

6.1.1 PRODUCT IDENTIFIER (PID)

The Product Identifier (PID) for the HITAG S Transponder IC is coded in the UID 3 Byte of the Unique Identifier (UID). This enables to distinguish between different ICs of the HITAG family.

UID3			
MSB			LSB
PID 1		PID 0	

Condition for HITAG S:
 PID 1 = 0x7 – 0xF and PID 0 ≠ 0x5 – 0x6

6.2 HITAG S Plain Mode

Page 1

In Plain Mode, Page 1 contains three configuration Bytes CON 0 to CON 2 and a reserved byte.

Page Address	MSByte				LSByte			
	MSB	LSB	MSB	LSB	MSB	LSB	MSB	LSB
0x01	Reserved		CON 2		CON 1		CON 0	

Page 2 - 63

In Plain Mode, Pages 2 – 63 can be used to store user data.

Page Address	MSByte				LSByte			
	MSB	LSB	MSB	LSB	MSB	LSB	MSB	LSB
0x02 – 0x3F	Data 3		Data 2		Data 1		Data 0	

Memory Map for HITAG S in Plain Mode:

Page Address	MSByte				LSByte			
	MSB	LSB	MSB	LSB	MSB	LSB	MSB	LSB
0x00	UID 3		UID 2		UID 1		UID 0	
0x01	Reserved		CON 2		CON 1		CON 0	
0x02	Data 3		Data 2		Data 1		Data 0	
0x03	Data 3		Data 2		Data 1		Data 0	

HITAG S

HTS IC H32/HTS IC H56/HTS IC H48

6.3 HITAG S Authentication Mode

Page 1

In Authentication Mode, Page 1 contains three configuration Bytes CON 0 to CON 2 and the password high Byte PWDH 0.

Page Address	MSByte			LSByte				
	MSB	LSB	MSB	LSB	MSB	LSB		
0x01	PWDH 0		CON 2		CON 1		CON 0	

Page 2

In Authentication Mode, Page 2 contains the password low Bytes PWDL 0 and PWDL 1 and the key high Bytes KEYH 0 and KEYH 1.

Page Address	MSByte			LSByte				
	MSB	LSB	MSB	LSB	MSB	LSB		
0x02	KEYH 1		KEYH 0		PWDL 1		PWDL 0	

Page 3

In Authentication Mode, Page 3 contains the key low Bytes KEYL 0 - KEYL 3.

Page Address	MSByte			LSByte				
	MSB	LSB	MSB	LSB	MSB	LSB		
0x03	KEYL 3		KEYL 2		KEYL 1		KEYL 0	

Page 4 - 63

Page Address	MSByte			LSByte				
	MSB	LSB	MSB	LSB	MSB	LSB		
0x04 – 0x3F	Data 3		Data 2		Data 1		Data 0	

Memory Map for HITAG S in Authentication Mode:

Page Address	MSByte			LSByte				
	MSB	LSB	MSB	LSB	MSB	LSB		
0x00	UID 3		UID 2		UID 1		UID 0	
0x01	PWDH 0		CON 2		CON 1		CON 0	
0x02	KEYH 1		KEYH 0		PWDL 1		PWDL 0	
0x03	KEYL 3		KEYL 2		KEYL 1		KEYL 0	
0x04	Data 3		Data 2		Data 1		Data 0	
0x05	Data 3		Data 2		Data 1		Data 0	

HITAG S

HTS IC H32/HTS IC H56/HTS IC H48

7 FUNCTIONAL DESCRIPTION

7.1 Basic System Configuration

The following block diagram shows in principle the HITAG system configuration

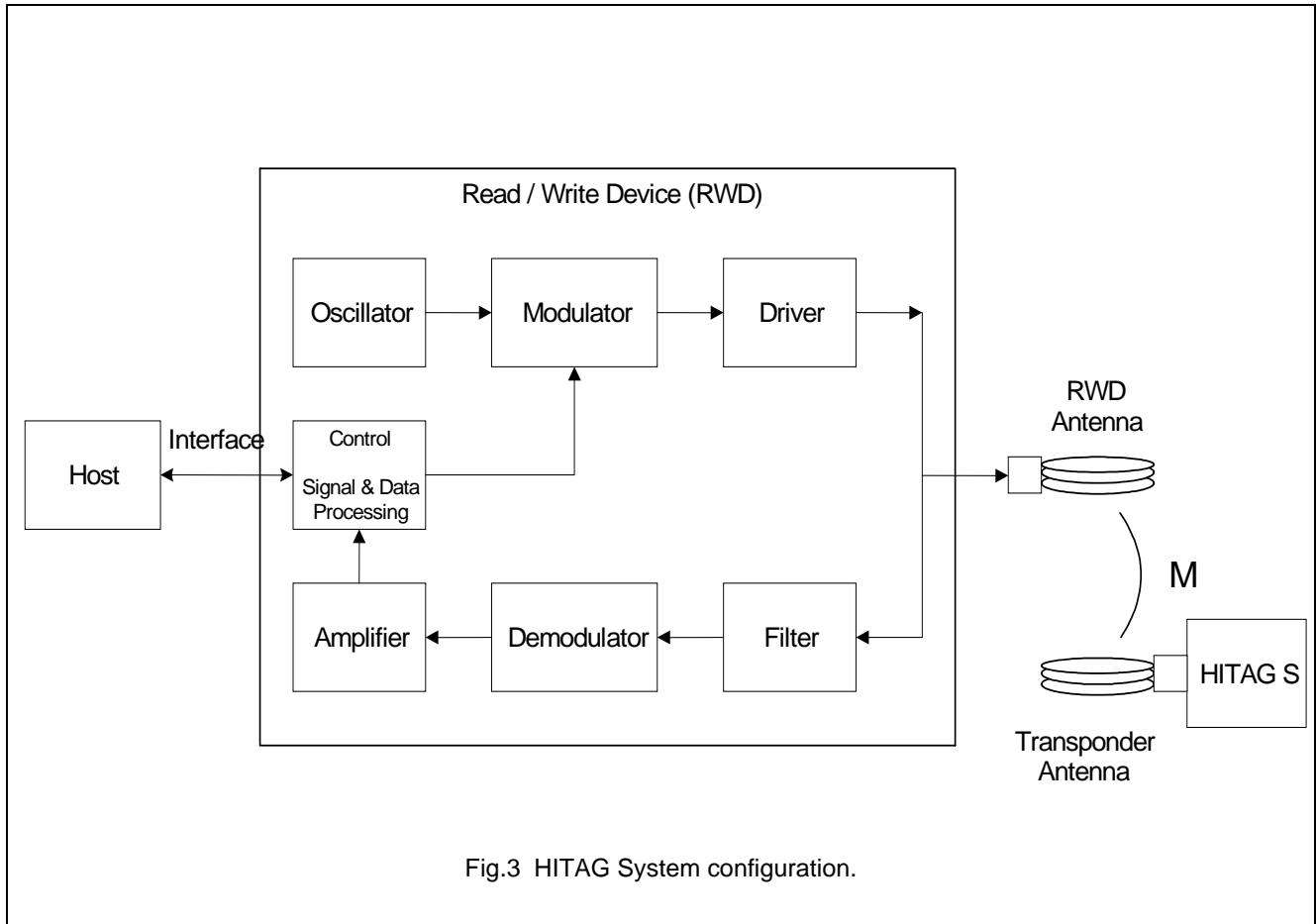

Fig.3 HITAG System configuration.

A control and data processing unit controls the modulation of the carrier signal and processes data coming back from the demodulator circuit.

HITAG S

HTS IC H32/HTS IC H56/HTS IC H48

7.2 Energy Transmission

Passive transponders must somehow be supplied with energy to be able to operate. In the HITAG System, this is achieved by using the principle of a loose coupled transformer:

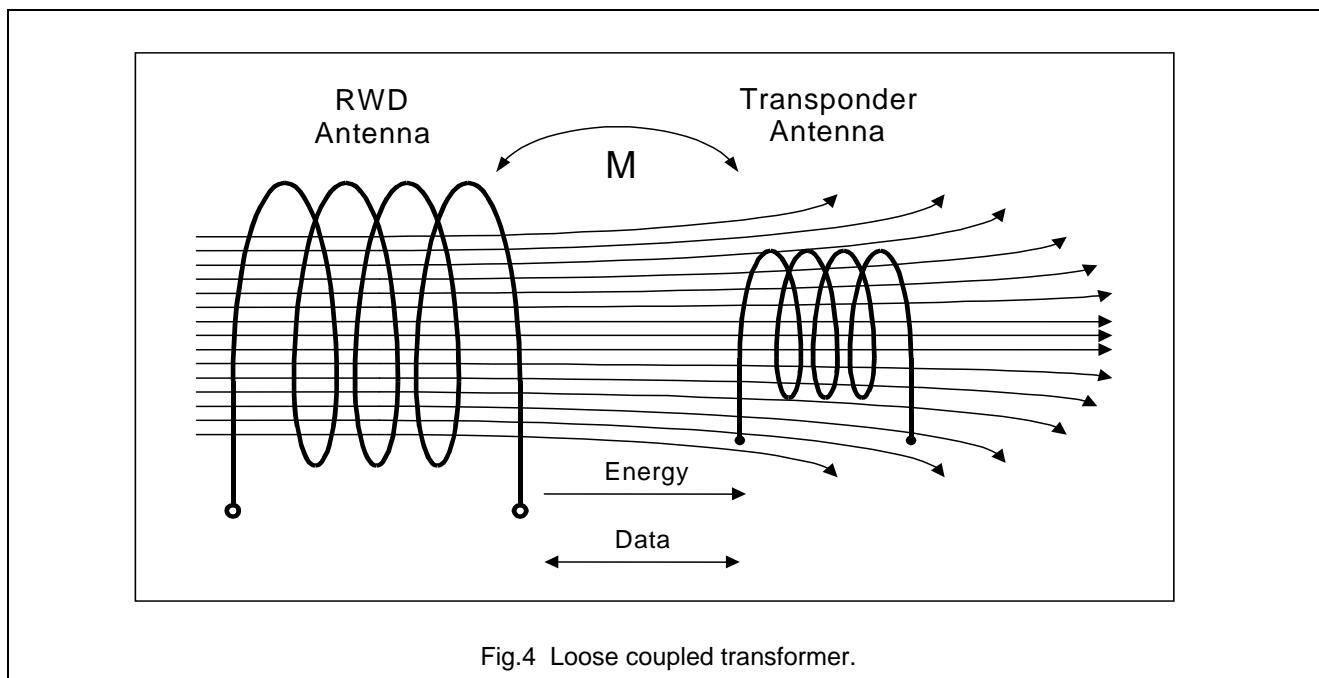

The RWD antenna generates a magnetic field. Some of the generated magnetic flux flows through the transponder antenna and induces a voltage there. The voltage drives a current and the transponder will start operating. As this current will be very small when the transponder is far away from the antenna, the HITAG S Transponder IC is designed for low power consumption.

The principle of a loose coupled transformer enables also a bi-directional data transmission.

HITAG S

HTS IC H32/HTS IC H56/HTS IC H48

7.3 Data Transmission: Transponder → Read/Write Device

For data transmission from the HITAG S Transponder to the RWD, the implemented method is called 'load modulation'. Here the HITAG S Transponder continuously changes the load on the magnetic field, by in principle turning on/off a resistor, according to the information to transmit. Alteration of the magnetic field is detected by the receiver of the RWD.

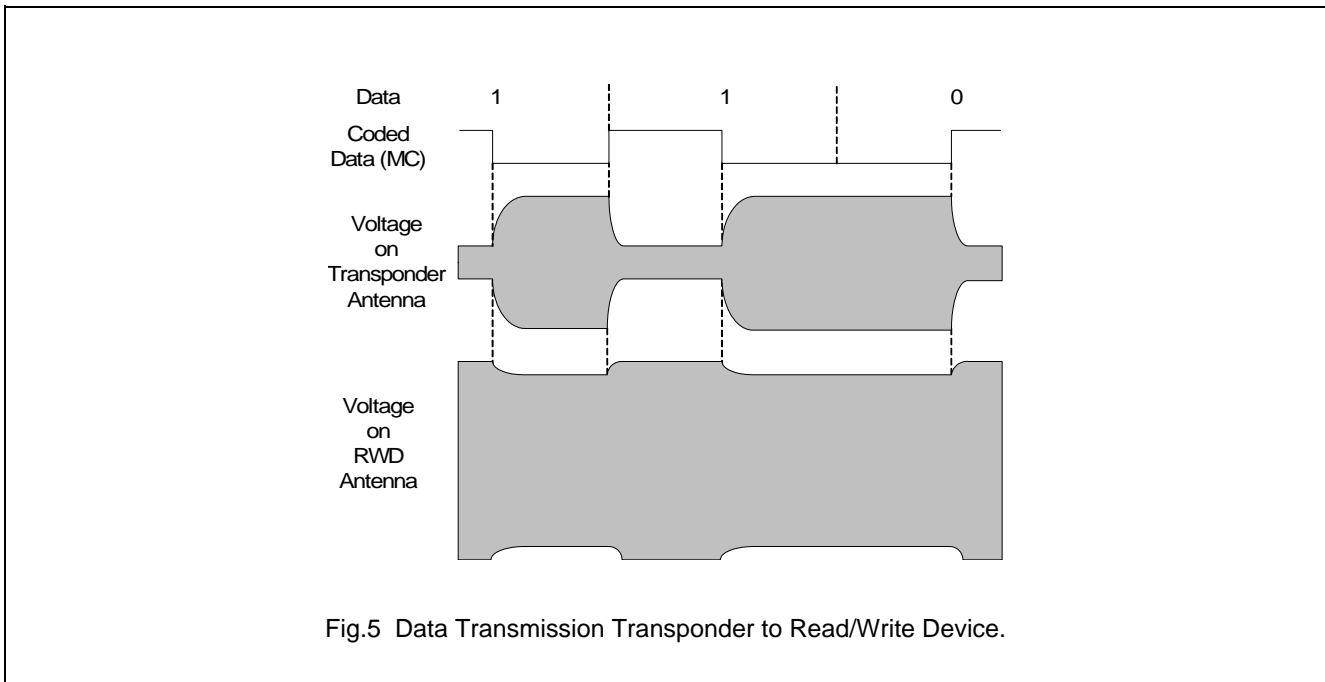

The modulation ratio of the RWD antenna voltage depends on the coupling factor of the antenna configuration (RWD antenna size, transponder antenna size, distance between the antennas,...).

HITAG S

HTS IC H32/HTS IC H56/HTS IC H48

7.3.1 CODING

Three different coding techniques for different States and Modes of the HITAG S Transponder IC are used (see also Chapters 11 “Command Set” and 12 “Transponder Talks First (TTF) Mode”):

- AC: **A**nticollision Coding in Init State
- MC: **M**anchester Coding in Selected State and in Transponder Talks First State
- BC: **B**iphase Coding in Transponder Talks First State

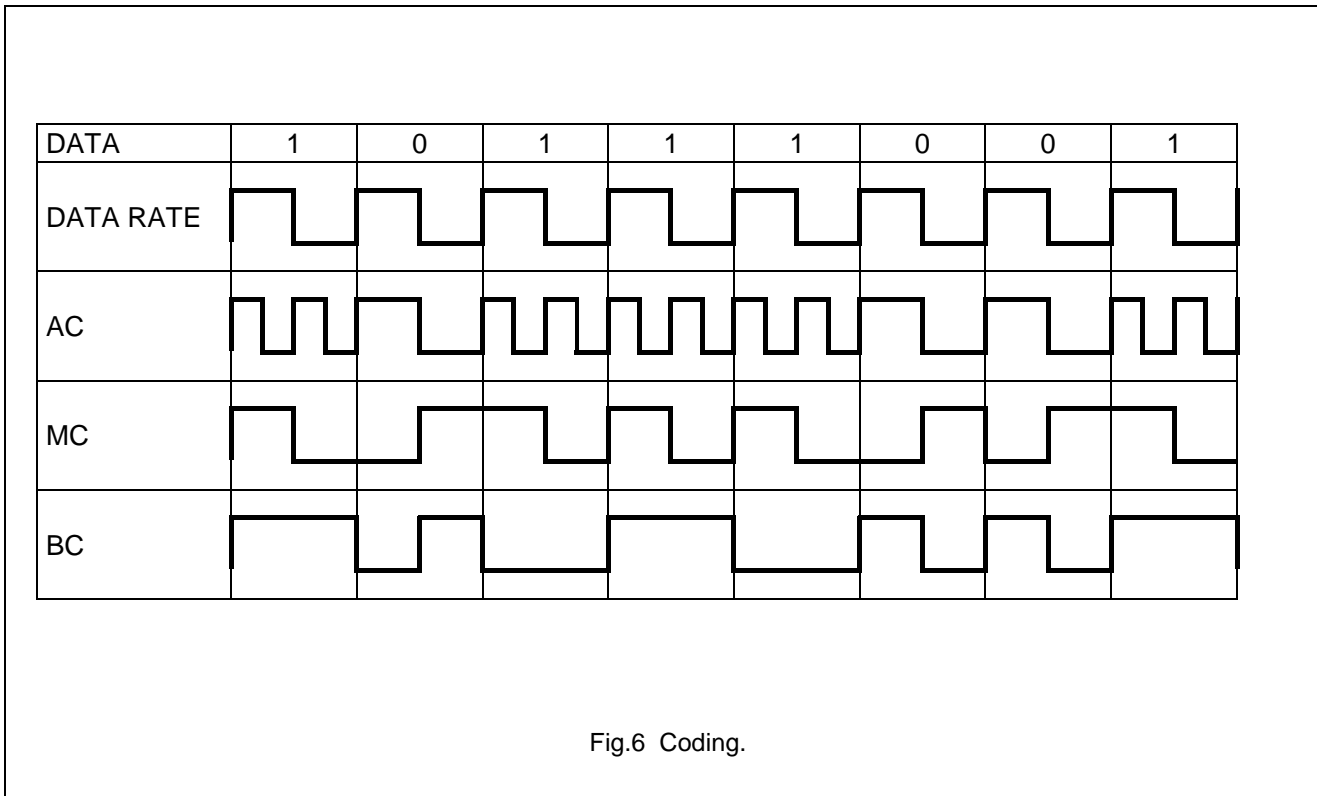

A high level of the above coding signals means the physical state ‘modulator on’ (field loaded), a low level means ‘modulator off’ (field unloaded).

HITAG S

HTS IC H32/HTS IC H56/HTS IC H48

7.3.2 DATA RATE

The data rate for HITAG S Transponder in Reader Talks First (RTF) Mode depends on the corresponding UID REQUEST xx command.

For Transponder Talks First (TTF) Mode the data rate can be defined by configuration

Table 1

MODE	CODING	BIT RATE	BIT LENGTH
HITAG S RTF Mode	AC	2 kBit/s	64 T ₀
		4 kBit/s	32 T ₀
	MC	4 kBit/s	32 T ₀
		8 kBit/s	16 T ₀
HITAG S TTF Mode	MC	2 kBit/s	64 T ₀
		4 kBit/s	32 T ₀
		8 kBit/s	16 T ₀
	Biphase	2 kBit/s	64 T ₀
		4 kBit/s	32 T ₀
		8 kBit/s	16 T ₀

Note

T₀... Carrier period time ($1/125 \text{ kHz} = 8 \text{ }\mu\text{s}$ nominal).

HITAG S

HTS IC H32/HTS IC H56/HTS IC H48

7.4 Data Transmission: Read/Write Device → Transponder (Physical Layer)

Data are transmitted to the transponder using Amplitude Shift Keying (ASK) modulation with a modulation index of 100 %. When the field is switched off, the physical state is named low field, otherwise high field.

7.4.1 CODING

Binary Pulse Length Coding (BPLC) is used to encode the data stream.

All coded data Bits and the end of frame (EOF) condition start with a low field of length T_g .

Afterwards the field is switched on again.

- '0' and '1' can be distinguished by the duration of $T[0]$ and $T[1]$.
- The end of the data transmission is characterised by an end of frame condition.

The following figure shows the data transmission from the Read/Write Device to the transponder.

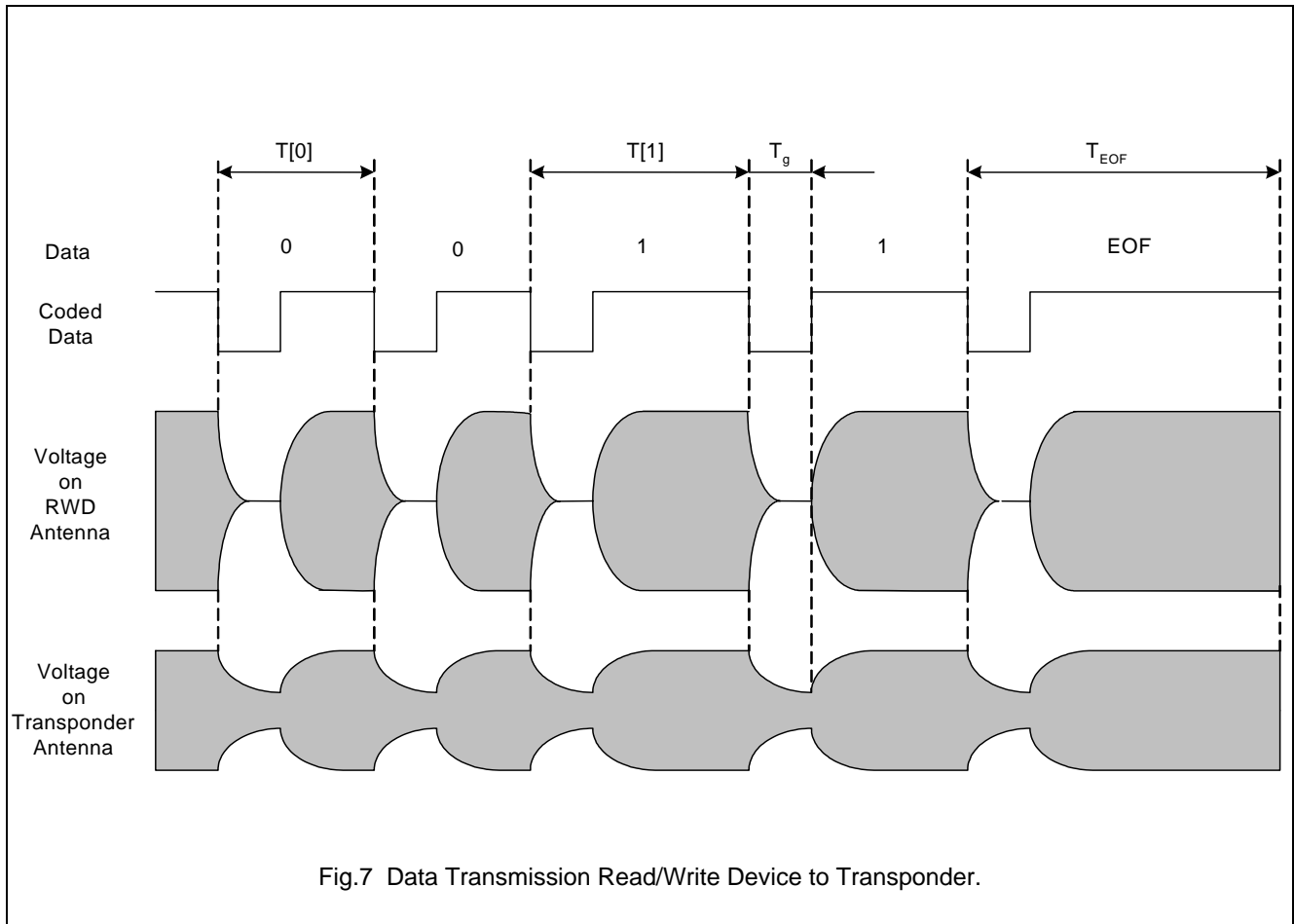

Fig.7 Data Transmission Read/Write Device to Transponder.

HITAG S

HTS IC H32/HTS IC H56/HTS IC H48

SYMBOL	DESCRIPTION	DURATION
T_g	Gap time	$4..10 T_0^{(1)}$
$T[0]$	Logic 0 Bit length	$18..22 T_0^{(1)}$
$T[1]$	Logic 1 Bit length	$26..30 T_0^{(1)}$
T_{EOF}	Duration for end of frame condition	$> 36 T_0$

Note

1. This application specific values must be within this frame, but have to be optimized for each application depending on rise and decay times of the RWD antenna voltage and the transponder antenna quality factor!

T_0 ... Carrier period time ($1/125 \text{ kHz} = 8 \mu\text{s}$ nominal).

The average Bit rate from the Read/Write Device to the HITAG S Transponder therefore is:

$$\text{Bit rate} = \frac{2}{T[0] + T[1]} = 5.2 \text{ kBit/s}$$

Note: The end of each data sequence from the Read/Write Device to the HITAG S Transponder has to be a EOF condition.

HITAG S

HTS IC H32/HTS IC H56/HTS IC H48

7.4.2 MODULATION DETAILS

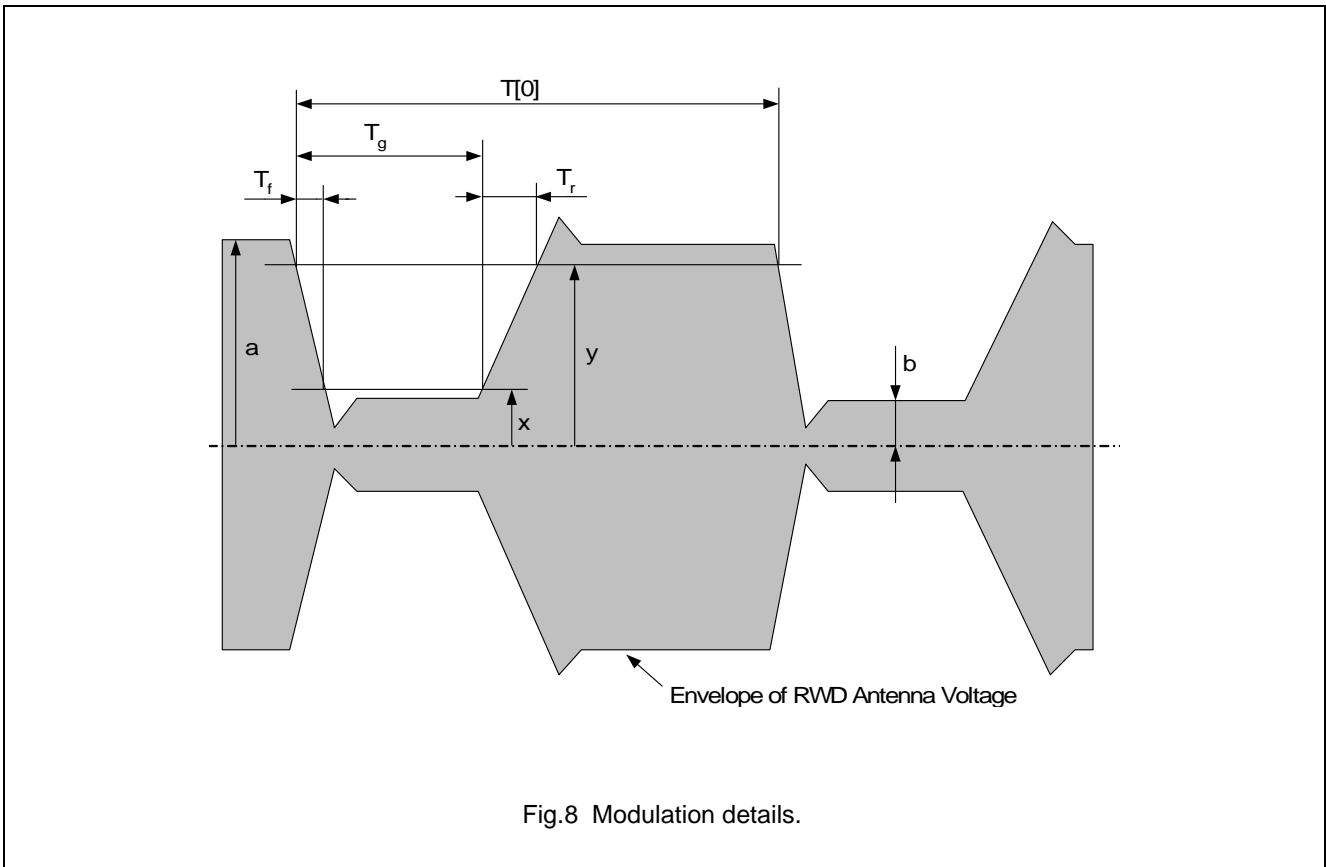

Fig.8 Modulation details.

$x = 0.05 a, y = 0.95 a$

$m = (a - b) / (a + b) \dots \dots$ Modulation index

The following table shows two examples of modulation timing parameters for typical short- and long range applications.

SYMBOL	MIN	MAX
m	95%	100%
T_f	0	$0.5 T_g$
$T_r^{(1)}$	0	$1 (T[0] - T_g)$

SYMBOL	SHORT RANGE APPLICATION	LONG RANGE APPLICATION
T_g	$6 T_0$	$9 T_0$
$T[0]$	$20 T_0$	$22 T_0$
$T[1]$	$28 T_0$	$28 T_0$
T_f	$3 T_0$	$4 T_0$
T_r	$4 T_0$	$5 T_0$

Note

1. This application specific value must be within this range, but has to be optimized depending on transponder coil quality factor and Read performance requirements. For high quality factor transponder coils, a lower rise time T_r should be implemented (recommended $T_r = 0.5 (T[0] - T_g)$) to achieve the maximum possible performance.

HITAG S

HTS IC H32/HTS IC H56/HTS IC H48

8 CONFIGURATION

8.1 Configuration Page

Memory Page 1 contains the three configuration Bytes CON 0, CON 1 and CON 2 (see Chapter “Memory Organisation”). Changes on the Configuration Bytes are effective after a power on reset of the HITAG S Transponder.

CON0: Memory Type Information

CON0

MSB						LSB	
RES 5	RES 4	RES 3	RES 2	RES 1	RES 0	MEMT 1	MEMT 0

The following table describes the **Memory Type Bits** MEMT 0 and MEMT 1 of configuration byte CON 0.

Table 2 Memory Type Bits MEMT 0 and MEMT 1

MEMT 1	MEMT 0	MEMORY TYPE
0	0	32 Bit
0	1	256 Bit
1	0	2048 Bit
1	1	Reserved

Bits RES 0 to RES 5 are reserved for future use. Only Read access to configuration byte CON 0 is possible.

CON 1: Mode and Lock Bits

CON1

MSB						LSB	
AUT	TTFC	TTFDR 1	TTFDR 0	TTFM 1	TTFM 0	LCON	LKP

If the **Authentication Bit** AUT = ‘0’ the HITAG S Transponder IC is configured in Plain Mode and can be selected directly by the SELECT (UID) command and the corresponding UID. For Bit AUT = ‘1’ the HITAG S Transponder IC is configured in Authentication Mode and can only be Selected with the SELECT (UID) command and a following secure CHALLENGE sequence (see also Chapters 10 “State Diagram” and 11 “Command Set”).

Table 3 Authentication Bit AUT

AUT	HITAG S MODE
0	Plain
1	Authentication

HITAG S

HTS IC H32/HTS IC H56/HTS IC H48

The **Transponder Talks First Coding Bit TTFC** defines the used coding during transmitting data to the RWD. This effects the TTF State only.

Table 4 Transponder Talks First Coding Bit TTFC

TTFC	CODING IN TTF STATE
0	Manchester
1	Biphase

The **Transponder Talks First Data Rate Bits TTFDR 0** and **TTFDR 1** select the data rate used during transmission of data to the RWD. This effects the TTF State only.

Table 5 Transponder Talks First Data Rate Bits TTFDR 0 and TTFDR 1

TTFDR 1	TTFDR 0	DATA RATE IN TTF STATE
0	0	4 kBit
0	1	8 kBit
1	0	2 kBit
1	1	2 kBit and Pigeon Race Standard

The **Transponder Talks First Mode Bits TTFM 0** and **TTFM 1** defines the number of Pages continuously transmitted to the RWD. This effects the TTF State only.

Table 6 Transponder Talks First Mode Bits TTFM 0 and TTFM 1

TTFM 1	TTFM 0	PAGES TRANSMITTED IN TTF STATE
0	0	TTF Mode disabled (= RTF Mode)
0	1	Page 4, Page 5
1	0	Page 4, Page 5, Page 6, Page 7
1	1	Page 4

The **Lock Configuration Bit LCON** defines the access rights on the configuration Bytes CON 1 and CON 2. This Bit is one time programmable (OTP).

Table 7 Lock Configuration Bit LCON

LCON	ACCESS RIGHT CON 1 AND CON 2
0	Read / Write
1	CON 1: Read Only. CON 2: OTP

HITAG S

HTS IC H32/HTS IC H56/HTS IC H48

The Lock Key and Password Bit LKP defines the access rights of the PWDH 0 Byte of Page 1, password low Bytes and key high Bytes of Page 2 and key low Bytes of Page 3 when configured in Authentication Mode. In Plain Mode this Bit can be used to lock the user data of Page 2 and Page 3.

Table 8 Lock Key and Password Bit LKP

LKP	ACCESS RIGHT KEY AND PASSWORD/PAGE 2 AND PAGE 3
0	Read / Write
1	Read Only in Plain Mode No Access in Authentication Mode

Attention: In order to prevent further access to key and password, the following procedure must take place: After setting Bit LKP to '1' the Lock Configuration Bit LCON must be set to '1', because the Bit LKP has no OTP functionality!

CON 2: Memory Lock Bits

CON2

MSB							LSB
LCK 7	LCK 6	LCK 5	LCK 4	LCK 3	LCK 2	LCK 1	LCK 0

Table 9 Description of Memory Lock Bits

BIT	SYMBOL	FUNCTION	ACCESS RIGHTS	COMMENT
7	LCK 7	Lock Page 4 and Page 5	0...Read / Write 1...Read Only	OTP if LCON = '1' If Pigeon Race Standard is enabled (TTFDR 0 = TTFDR 1 = '1') 16 Bits (Data 3 u. Data 2) of Page 5 remain still Read/Write accessible for LCK 7 = '1'
6	LCK 6	Lock Page 6 and Page 7	0...Read / Write 1...Read Only	OTP if LCON = '1'
5	LCK 5	Lock Page 8 – Page 11	0...Read / Write 1...Read Only	OTP if LCON = '1'
4	LCK 4	Lock Page 12 – Page 15	0...Read / Write 1...Read Only	OTP if LCON = '1'
3	LCK 3	Lock Page 16 – Page 23	0...Read / Write 1...Read Only	OTP if LCON = '1'
2	LCK 2	Lock Page 24 – Page 31	0...Read / Write 1...Read Only	OTP if LCON = '1'
1	LCK 1	Lock Page 32 – Page 47	0...Read / Write 1...Read Only	OTP if LCON = '1'
0	LCK 0	Lock Page 48 – Page 63	0...Read / Write 1...Read Only	OTP if LCON = '1'

HITAG S

HTS IC H32/HTS IC H56/HTS IC H48

8.2 Delivery Configuration

8.2.1 HITAG S32

This delivery configuration is valid for the following HITAG S 32 types:

- HTS IC **H32** 01EW/V4
- HTS MO **H32** 01EV
- HTS FC **H32** 01EV/DH

MSByte						LSByte	
MSB	LSB	MSB	LSB	MSB	LSB	MSB	LSB
UID 3		UID 2		UID 1		UID 0	

The 32 Bit Unique Identifier (UID) is programmed during the manufacturing process. Access rights: Read Only (RO).

On a Select (UID) command the HITAG S 32 Transponder IC sends back three Reserved Bytes and the Byte CON 0 containing the Memory Type Information.

MSByte						LSByte	
MSB	LSB	MSB	LSB	MSB	LSB	MSB	LSB
X		X		X		CON0	

CON 0							
MSB						LSB	
X	X	X	X	X	X	0	0

The content of Bits and Bytes marked with 'X' are **not** defined at delivery!

HITAG S

HTS IC H32/HTS IC H56/HTS IC H48

8.2.2 HITAG S256

This delivery configuration is valid for the following HITAG S 256 types:

- HTS IC **H56** 01EW/V4
- HTS MO **H56** 01EV
- HTS FC **H56** 01EV/DH

Page Address	MSByte				LSByte			
	MSB	LSB	MSB	LSB	MSB	LSB	MSB	LSB
0x00	UID 3		UID 2		UID 1		UID 0	
0x01	0xAA		0x00		0x00		CON 0	
0x02	0x4E		0x4F		0x54		0x48	
0x03	0x52		0x4B		0x49		0x4D	
0x04	X		X		X		X	
0x05	X		X		X		X	
0x06	X		X		X		X	
0x07	X		X		X		X	

CON 0

MSB							LSB
X	X	X	X	X	X	0	1

The content of Bits and Bytes marked with 'X' are **not** defined at delivery!

- The 32 Bit Unique Identifier (UID) is programmed during the manufacturing process.
- Modes: Reader Talks First (RTF), Plain
- Access Rights:
 - UID: Read Only
 - Page 1: Read/Write with exception of byte CON 0 (Read Only)
 - Page 2 – Page 7: Read/Write

HITAG S

HTS IC H32/HTS IC H56/HTS IC H48

8.2.3 HITAG S2048

This delivery configuration is valid for the following HITAG S 2048 types:

- HTS IC **H48** 01EW/V4
- HTS MO **H48** 01EV
- HTS FC **H48** 01EV/DH

Page Address	MSByte				LSByte			
	MSB	LSB	MSB	LSB	MSB	LSB	MSB	LSB
0x00	UID 3		UID 2		UID 1		UID 0	
0x01	0xAA		0x00		0x00		CON 0	
0x02	0x4E		0x4F		0x54		0x48	
0x03	0x52		0x4B		0x49		0x4D	
0x04	X		X		X		X	
0x05	X		X		X		X	
0x3E	X		X		X		X	
0x3F	X		X		X		X	

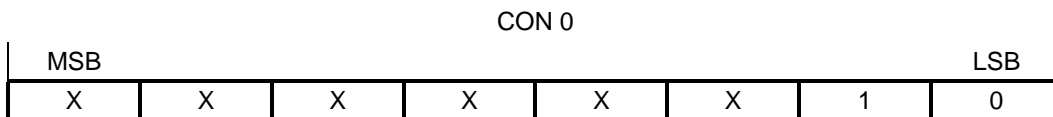

The content of Bits and Bytes marked with 'X' are **not** defined at delivery!

- The 32 Bit Unique Identifier (UID) is programmed during the manufacturing process.
- Modes: Reader Talks First (RTF), Plain
- Access Rights:
 - UID: Read Only
 - Page 1: Read/Write with exception of byte CON 0 (Read Only)
 - Page 2 – Page 63: Read/Write

HITAG S

HTS IC H32/HTS IC H56/HTS IC H48

9 PROTOCOL TIMING

9.1 Read/Write Device waiting time before sending the first command

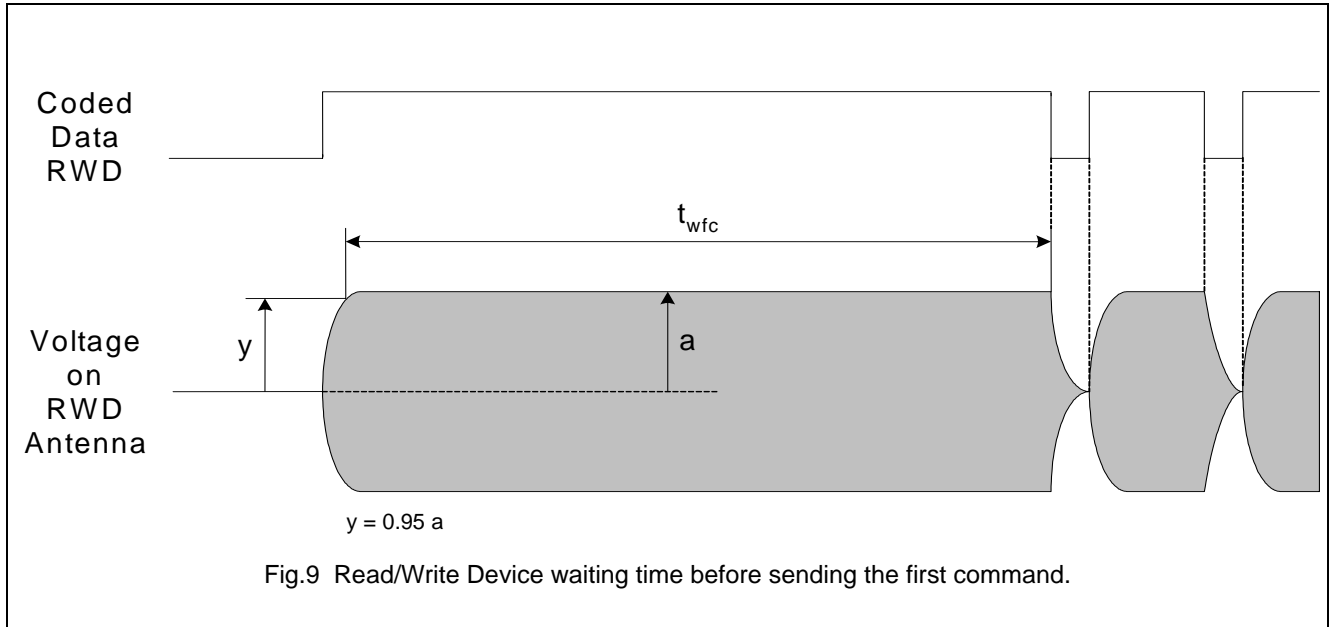

After switching on the powering field, the Read/Write Device has to wait at least the minimum time $t_{wfc} = 280 T_0$ before sending the first command. The first command must not be sent later than the maximum time $t_{wfc} = 5000 T_0$.

Table 10

	MIN	TYP	MAX	UNIT
t_{wfc}	280		5000	T_0

HITAG S

HTS IC H32/HTS IC H56/HTS IC H48

9.2 Read/Write Device waiting time before sending a subsequent command

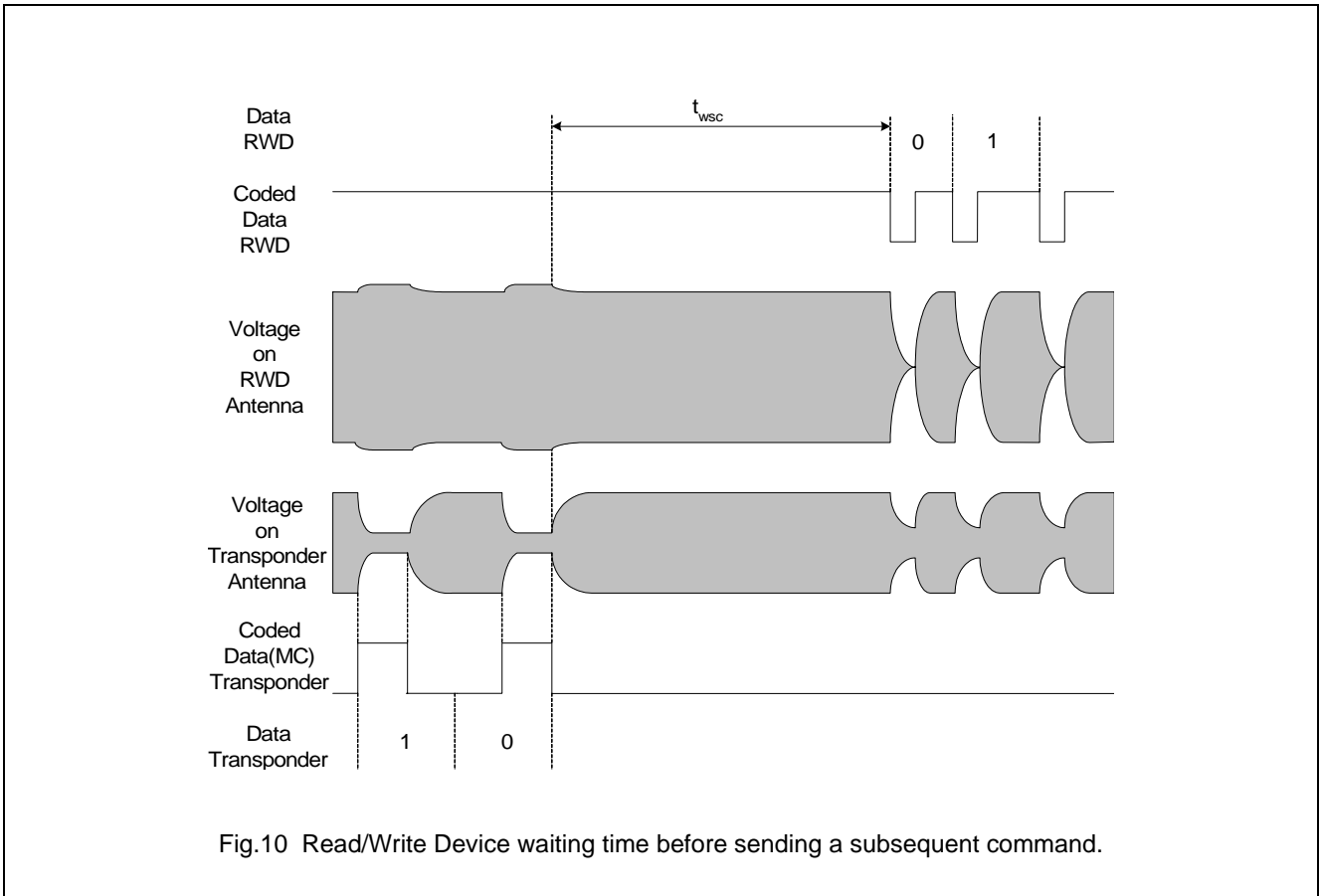

Fig.10 Read/Write Device waiting time before sending a subsequent command.

When the Read/Write Device has received the response from the HITAG S Transponder to a previous command, the RWD has to wait at least the minimum time $t_{wsc} = 90 T_0$ before sending a subsequent command or Write data after a Write command. The subsequent command or Write data must not be sent later than the maximum time $t_{wsc} = 5000 T_0$.

Table 11

	MIN	TYP	MAX	UNIT
t_{wsc}	90		5000	T_0

HITAG S

HTS IC H32/HTS IC H56/HTS IC H48

9.3 Reset Time

The powering field must be switched off for at least $t_{reset} = 4.8$ ms to generate a reset of the HITAG S IC and to enter it into Power Off State.

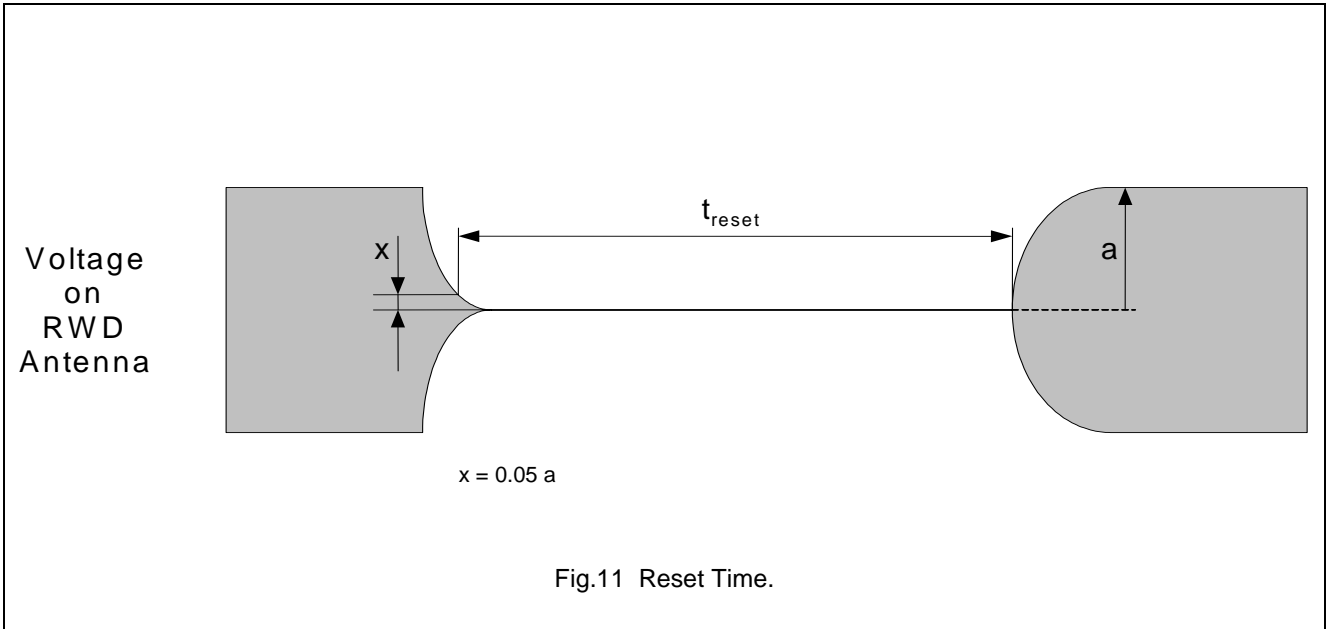

Table 12

	MIN	TYP	MAX	UNIT
t_{reset}	4.8			ms

HITAG S

HTS IC H32/HTS IC H56/HTS IC H48

9.4 HITAG S Transponder waiting time before transmitting a response after receiving an EOF

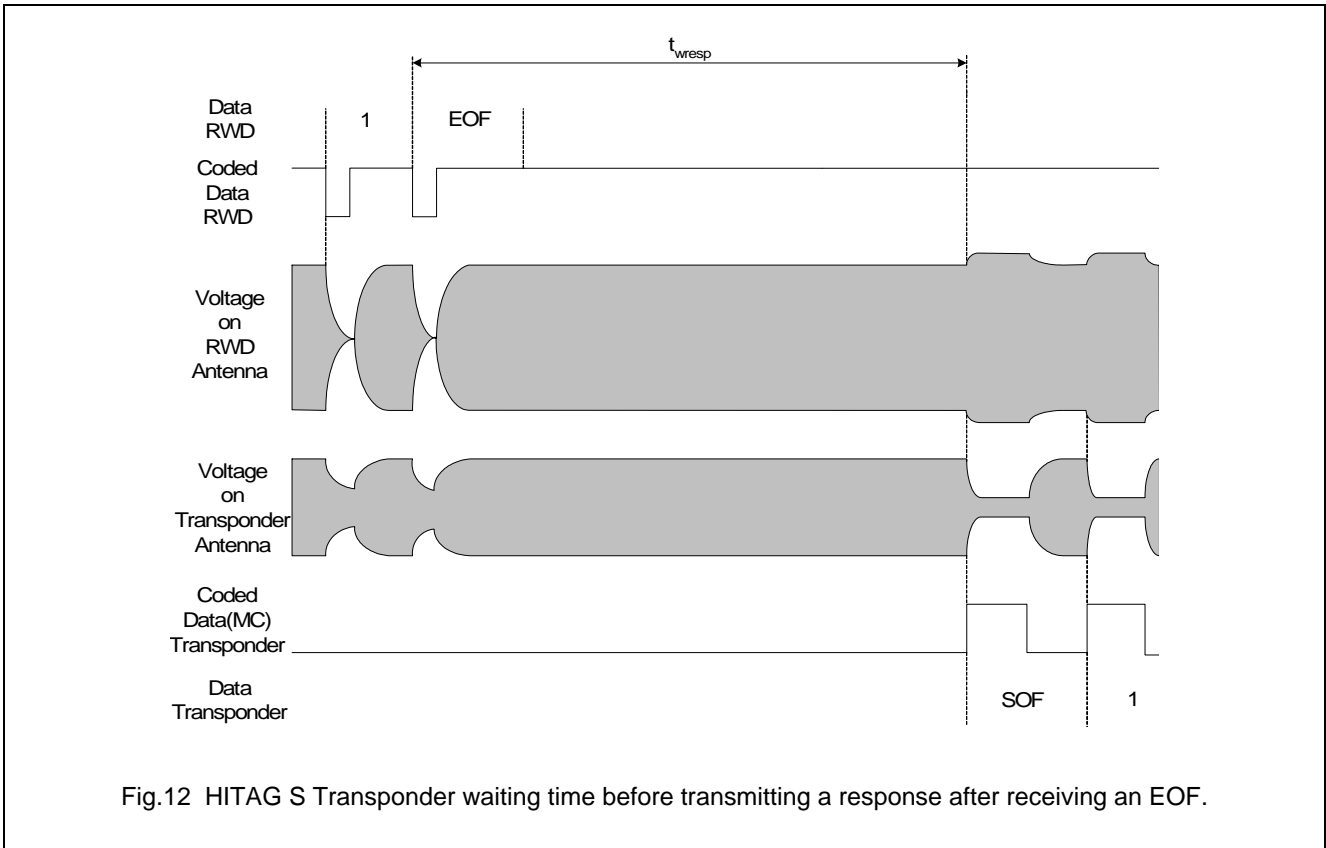

Fig.12 HITAG S Transponder waiting time before transmitting a response after receiving an EOF.

When receiving a End of Frame (EOF) condition from the Read/Write Device, the transponder waits t_{wresp} before transmitting data. The values given below are specific to transmission system parameters e.g. coil quality factor, RWD antenna quality factor.

Table 13

	MIN	TYP	MAX	UNIT
$t_{wresp}^{(1)}$	204	208	212	T_0

Note

- 1. Valid for coil quality factors $Q_{coil} < 30$.

HITAG S

HTS IC H32/HTS IC H56/HTS IC H48

9.5 HITAG S Transponder programming time

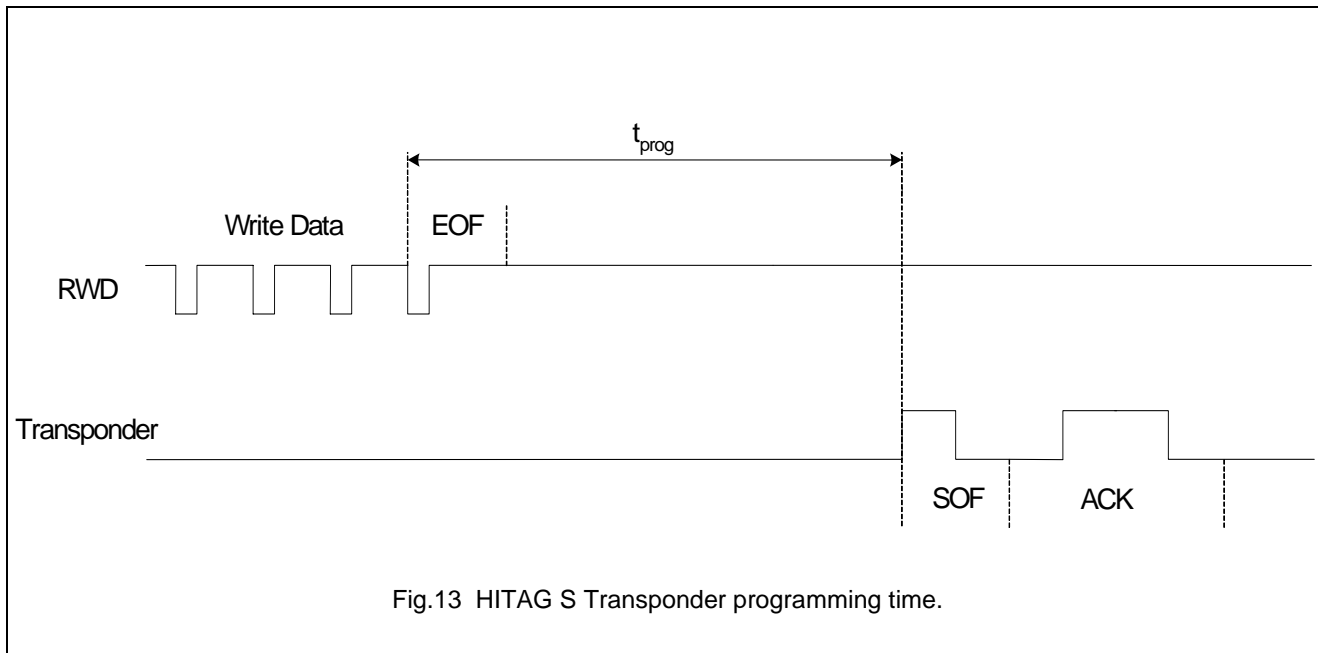

When receiving the EOF of the write data from the Read/Write Device, the transponder waits t_{prog} before transmitting the SOF and acknowledge to confirm correct programming.

Table 14

	MIN	TYP	MAX	UNIT
t_{prog}	716	721	726	T_0

HITAG S

HTS IC H32/HTS IC H56/HTS IC H48

9.6 HITAG S Transponder waiting time before transmitting data in TTF Mode

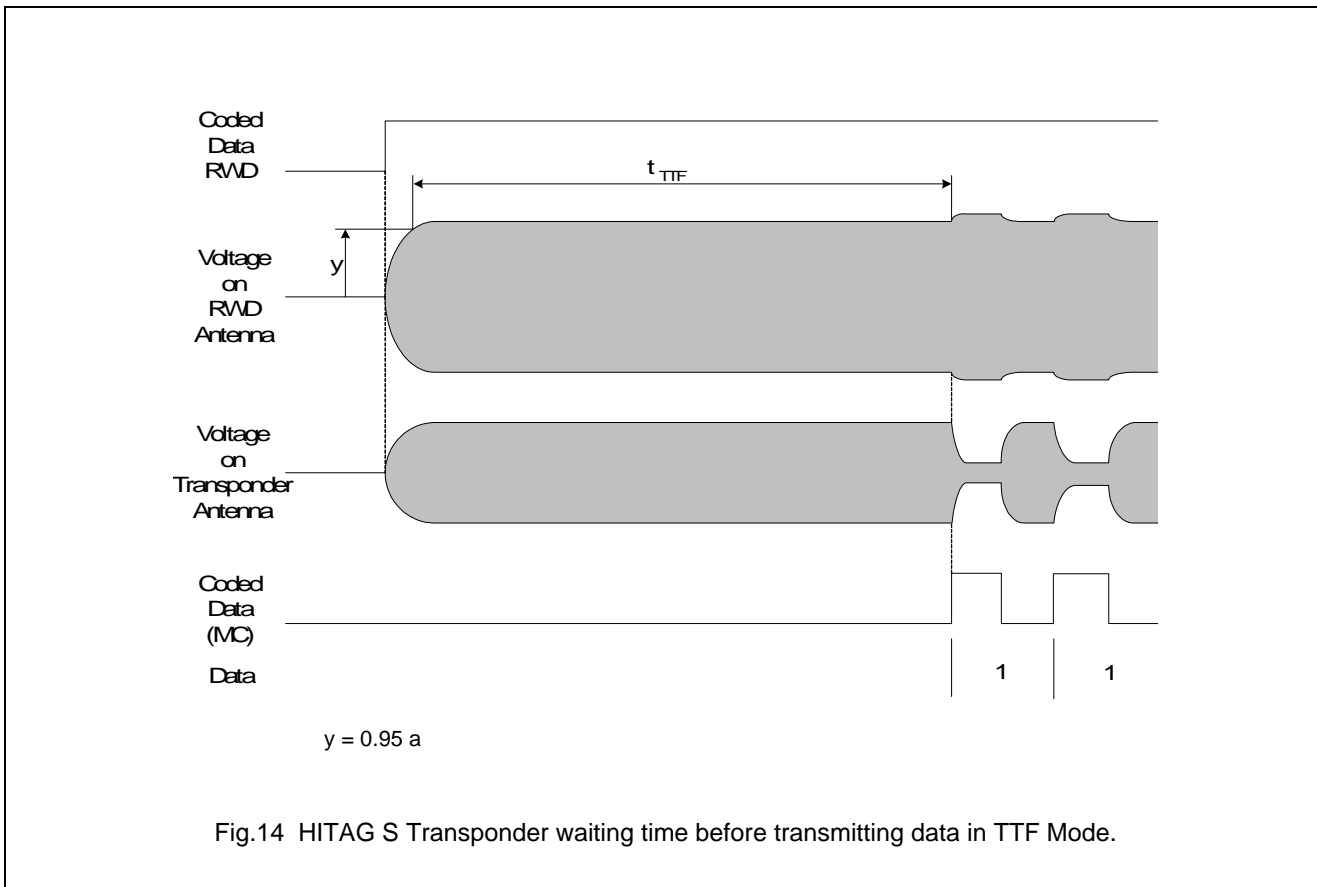

After switching on the powering field, the HITAG S Transponder waits a time t_{TTF} before transmitting data if it is configured in TTF Mode.

Table 15

	MIN	TYP	MAX	UNIT
t_{TTF}	565	585	625	T_0

HITAG S

HTS IC H32/HTS IC H56/HTS IC H48

9.7 HITAG S Transponder Mode switching time

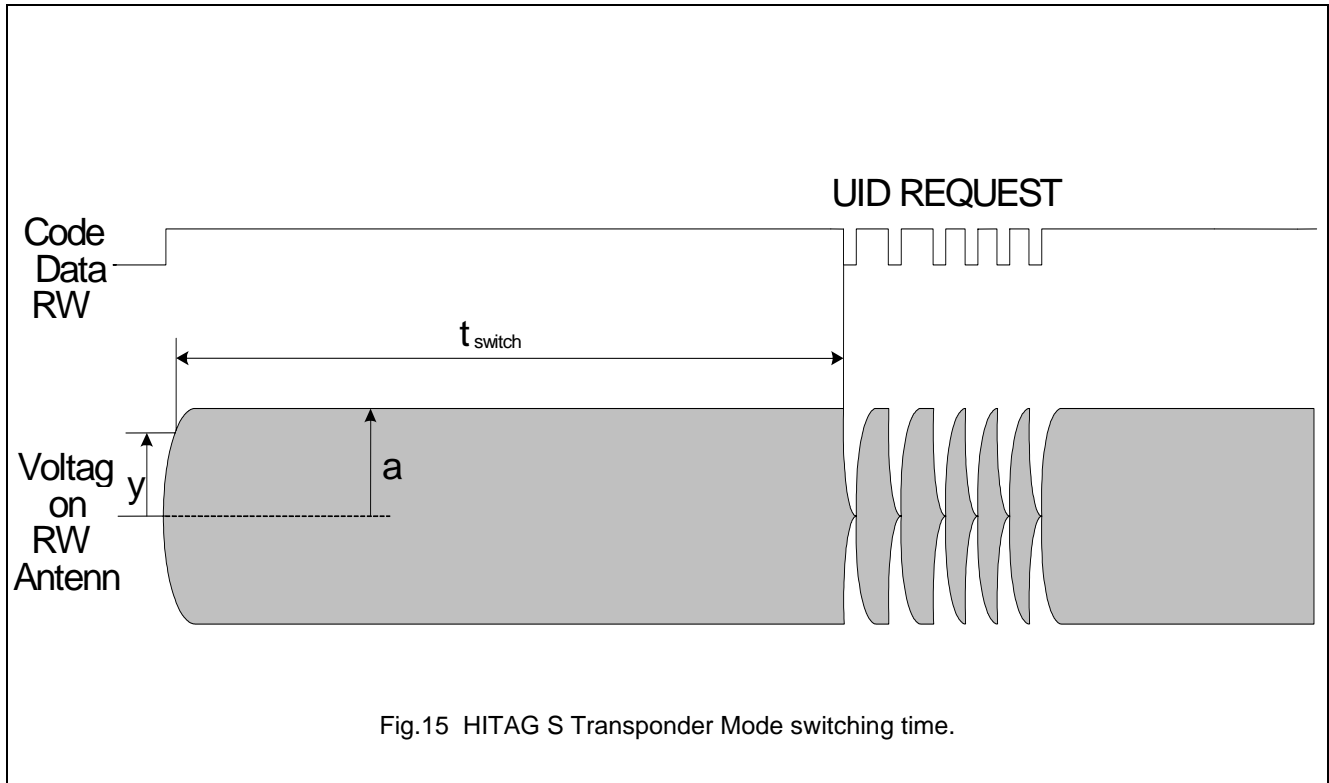

With an UID REQUEST xx command starting with the first bit after t_{switch} , a HITAG S Transponder configured in TTF Mode can be switched into RTF Mode. The Read/Write Device has to wait at least the minimum time $t_{switch} = 280 T_0$ and must not wait longer than the maximum time $t_{switch} = 520 T_0$. The HITAG S Transponder responds to this command with the UID and changes into Init State.

Table 16

	MIN	TYP	MAX	UNIT
t_{switch}	280	400	520	T_0

HITAG S

HTS IC H32/HTS IC H56/HTS IC H48

10 STATE DIAGRAM

10.1 General Description of States

Power Off

The powering magnetic field is switched off or the HITAG S Transponder is out of field.

Ready

After start up phase, the HITAG S Transponder is ready to receive the first command.

Init

The HITAG S Transponder enters this State after the first UID REQUEST xx command. In this State the Response Protocol Mode (see Chapter11 "Command Set") may be changed by further UID REQUEST xx commands. If there are several HITAG S Transponders in the field of the RWD antenna at the same time, the AC SEQUENCE can be started to determine the UID of every HITAG S Transponder.

Authenticate

The HITAG S Transponder enters this State after a valid SELECT (UID) command when configured in Authentication Mode. After an encrypted CHALLENGE Authentication the HITAG S Transponder changes into the Selected State.

Selected

The HITAG S Transponder enters this State after a valid SELECT (UID) command when configured in Plain Mode or a SELECT (UID) and CHALLENGE sequence when configured in **Authentication Mode**. Only one HITAG S Transponder in the field of the RWD antenna can be Selected at the same time. In this State, Read and Write operations are possible. Data Transmission is not encrypted even if configured in Authentication Mode.

Quiet

The HITAG S Transponder enters this State after a SELECT_QUIET command in Init State or a QUIET command in Selected State. In this State, the HITAG S Transponder will not answer to any command. Switching off the powering magnetic field or moving the HITAG S Transponder out of field enters it into the Power Off State.

Transponder Talks First (TTF)

The HITAG S Transponder enters this State when configured in TTF Mode if no UID REQUEST xx command is received within the Mode switch window. Once entered this State, the HITAG S Transponder continuously transmits data with configurable data coding, data rate and data length.

HITAG S

HTS IC H32/HTS IC H56/HTS IC H48

10.2 HITAG S 32

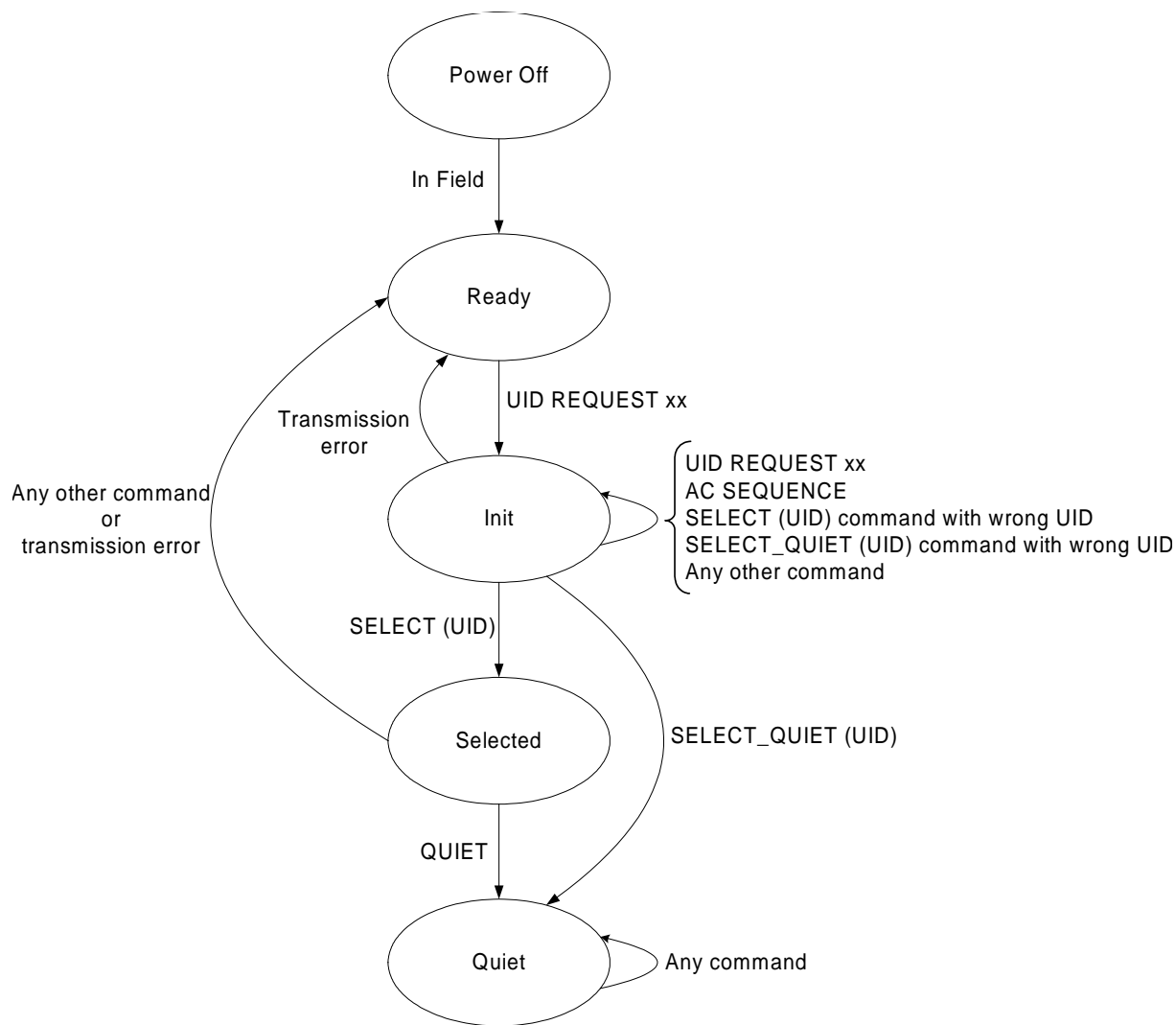

Fig.16 State diagram HITAG S 32.

Note:

Switching off the powering magnetic field or moving the HITAG S Transponder out of the RWD antenna field, enters the HITAG S Transponder into the Power Off State, independently of its actual State.

HITAG S

HTS IC H32/HTS IC H56/HTS IC H48

10.3 HITAG S 256 and HITAG S 2048

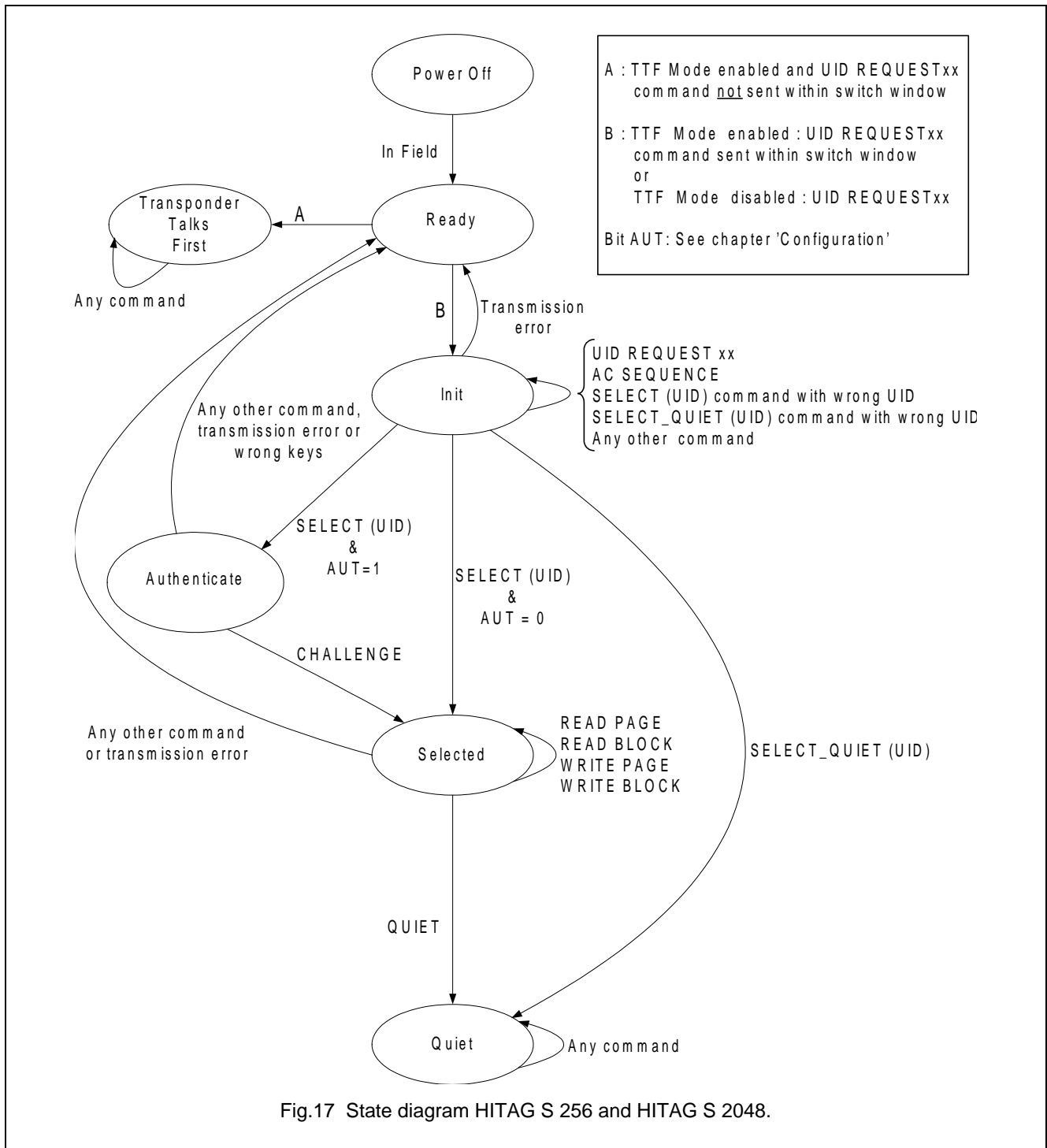

Fig.17 State diagram HITAG S 256 and HITAG S 2048.

Note:

Switching off the powering magnetic field or moving the HITAG S Transponder out of the RWD antenna field, enters the HITAG S Transponder into the Power Off State, independently of its actual State.

HITAG S

HTS IC H32/HTS IC H56/HTS IC H48

11 COMMAND SET

11.1 General Comments

For HITAG S 32 only the commands described in the corresponding State diagram are valid commands.

11.2 UID REQUEST xx

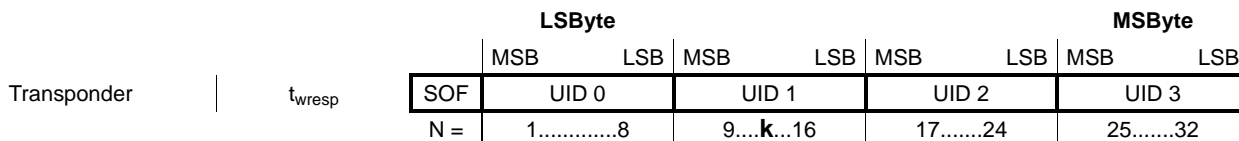

N...physical Bit position during air transmission. N=25 is the bit with the highest valence 2^{31} .

k...Any collision position (see command AC SEQUENCE)

After the RWD transmits this command, all HITAG S Transponders located in the field of the RWD antenna respond with a start of frame pattern followed by the corresponding 32 Bit UID. The complete response of the HITAG S Transponder is transmitted in Anticollision Coding (AC, see Section 7.3.1 "Coding").

Table 17 Coding

	MSB	LSB	RESPONSE PROTOCOL MODE
UID REQUEST Std	0	0 1 1 0	Standard
UID REQUEST Adv	1	1 0 0 x	Advanced
UID REQUEST FAdv	1	1 0 1 0	Fast Advanced

Note

- 1. x... can be '0' or '1'

The Response Protocol Mode defined by the corresponding UID Request command determines the coding, data rate and the SOF pattern of the HITAG S Transponder response.

Table 18

RESPONSE PROTOCOL MODE	SOF	CODING	DATA RATE
Standard	'1'	AC	2 kBit/s
Advanced	'111'	AC	2 kBit/s
Fast Advanced	'111'	AC	4 kBit/s

A HITAG S Transponder in Ready State changes into Init State after receiving a correct UID REQUEST xx command.

A HITAG S Transponder being already in Init State remains in Init State after receiving a further correct UID REQUEST xx command.

Always the latest UID REQUEST xx command defines the Response Protocol Mode for the following commands.

HITAG S

HTS IC H32/HTS IC H56/HTS IC H48

11.3 AC SEQUENCE

If more than one HITAG S Transponder is in the field of the antenna a special designed RWD detects the first collision at the **Bit position $N = k$** of the UID response. As a result the RWD starts an Anticollision Sequence (AC SEQUENCE).

This command consists of a 5 Bit number (k_4 to k_0) describing the physical Bit position k where the collision occurred followed by $(k - 1)$ Bits of the detected UID and a Bit (one or zero) at the collision position. An 8 Bit CRC (cyclic redundancy check) of this sequence is also sent to the transponders.

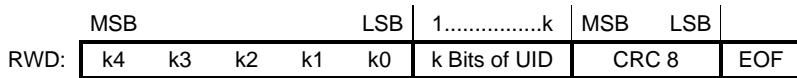

After transmitting this command, all HITAG S Transponders which first k Bits of the own UID match with the k received UID Bits, answer with the SOF and the rest of their own UID.

If a collision occurs again the described cycle has to be repeated until one valid UID of the transponders in the field is determined.

The complete response of the HITAG S Transponder is transmitted in Anticollision Coding (AC).

Table 19

RESPONSE PROTOCOL MODE	SOF	CODING	DATA RATE
Standard	'1'	AC	2 kBit/s
Advanced	'111'	AC	2 kBit/s
Fast Advanced	'111'	AC	4 kBit/s

During the AC SEQUENCE commands the HITAG S Transponder stays in Init State. **Even those HITAG S Transponders where the k received Bits of the UID do not match remain in Init State.**

HITAG S

HTS IC H32/HTS IC H56/HTS IC H48

11.4 SELECT (UID)

The SELECT (UID) command consists of 5 Zero-Bits followed by the determined 32 Bit UID and an 8 Bit Cyclic Redundancy Check (CRC). The selected transponder then responds with a start of frame pattern (SOF) followed by the content of the Configuration Page and depending on the Response Protocol Mode with an 8 Bit CRC.

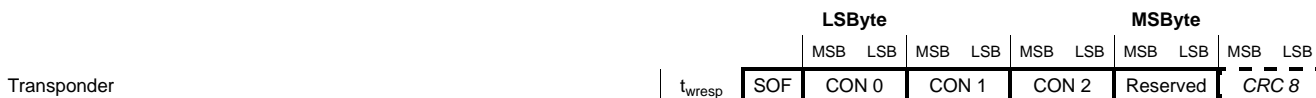
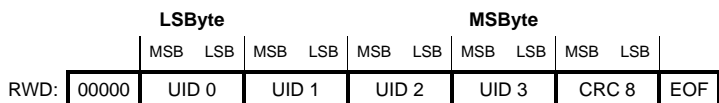

The complete response of the HITAG S Transponder is transmitted in Manchester Coding (MC).

In Plain Mode the MSByte of Page 1 is a Reserved Byte, in Authentication Mode this Byte contains the password high Byte PWDH 0. At the response on a SELECT (UID) command of a HITAG S Transponder configured in Authentication Mode (Bit AUT = 1, keys and password locked), this PWDH 0 Byte is dissolved by '1' Bits.

Table 20

RESPONSE PROTOCOL MODE	SOF	CRC8	CODING	DATA RATE
Standard	'1'	no	MC	4 kBit/s
Advanced	'111111'	yes	MC	4 kBit/s
Fast Advanced	'111111'	yes	MC	8 kBit/s

In Plain Mode (Bit AUT = 0) the HITAG S Transponder changes into Selected State after receiving a correct SELECT (UID) command.

In Authentication Mode (Bit AUT = 1) the HITAG S Transponder changes into Authenticate State after receiving a correct SELECT (UID) command and waits for the CHALLENGE command.

HITAG S

HTS IC H32/HTS IC H56/HTS IC H48

11.5 CHALLENGE

By means of the response of the SELECT (UID) command the RWD detects that the HITAG S Transponder is configured in Authentication Mode (Bit AUT = 1) and starts the encrypted Challenge sequence.

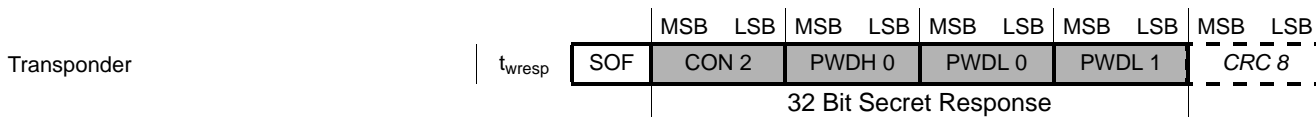
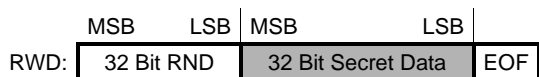

The Read/Write Device sends a 32 Bit Random Number (RND) and a 32 Bit secret data stream to the transponder. In order to perform the secret data stream, a security co-processor is required on the read/write Device. For more information please contact us at - info.bli@philips.com.

If the received secret data stream corresponds with the secret data stream calculated by the HITAG S Transponder, a 32 Bit Secret Response (secret data stream encrypting the configuration byte CON 2, password high byte PWDH 0 and password low Bytes PWDL 0 and PWDL 1) is transmitted after the SOF.

The response of the HITAG S Transponder is transmitted in Manchester Coding (MC).

Table 21

RESPONSE PROTOCOL MODE	SOF	CRC8	CODING	DATA RATE
Standard	'1'	no	MC	4 kBit/s
Advanced	'111111'	yes	MC	4 kBit/s
Fast Advanced	'111111'	yes	MC	8 kBit/s

A HITAG S Transponder configured in Authentication Mode changes from Authenticate State into Selected State only after a correct CHALLENGE Sequence.

Note: Even with AUT=1 further data transmission for read and write commands is done in plain mode.

HITAG S

HTS IC H32/HTS IC H56/HTS IC H48

11.6 SELECT_QUIET (UID)

With this command a HITAG S Transponder in Init State can be directly entered into the Quiet State.

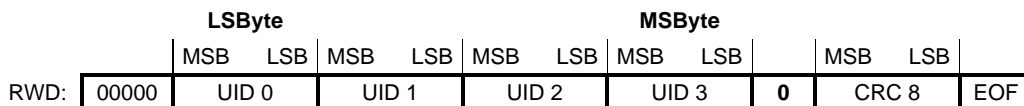

The 'start of frame' (SOF) pattern and the acknowledge (ACK) is transmitted in Manchester Coding.

Table 22

RESPONSE PROTOCOL MODE	SOF	CODING	DATA RATE
Standard	'1'	MC	4 kBit/s
Advanced	'111111'	MC	4 kBit/s
Fast Advanced	'111111'	MC	8 kBit/s

A HITAG S Transponder, once entered the Quiet State can only be enabled by switching off the powering magnetic field for at least a time t_{reset} or the HITAG S Transponder must be moved out of the antenna field (Power Off State).

11.7 READ PAGE

After a HITAG S Transponder was selected by the corresponding SELECT (UID) command (or SELECT (UID) and CHALLENGE for Authentication Mode) a read operation of data stored on the EEPROM can be performed. After transmitting the READ PAGE command, the Page address PADR (8 Bits) and the 8 Bit Cyclic Redundancy Check CRC 8, the HITAG S Transponder responds with the SOF and 32 Bits data of the corresponding Page.

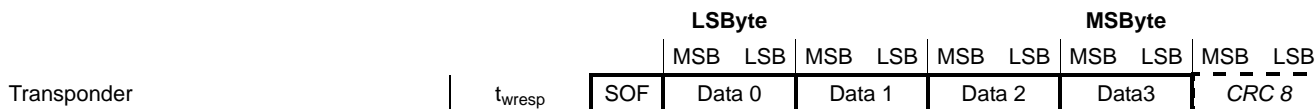
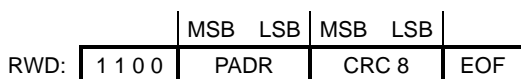

The highest Page address (PADR) is 0x 3F, therefore the two highest Bits must be '0'.

Table 23

RESPONSE PROTOCOL MODE	SOF	CRC8	CODING	DATA RATE
Standard	'1'	no	MC	4 kBit/s
Advanced	'111111'	yes	MC	4 kBit/s
Fast Advanced	'111111'	yes	MC	8 kBit/s

HITAG S

HTS IC H32/HTS IC H56/HTS IC H48

11.8 READ BLOCK

After transmitting the READ BLOCK command, the Page address PADR (8 Bits) within a block and the 8 Bit Cyclic Redundancy Check CRC 8, the HITAG S Transponder responds with the SOF and 32 up to 128 Bits of data beginning with the addressed Page within a Block to the last Page of the corresponding Block.

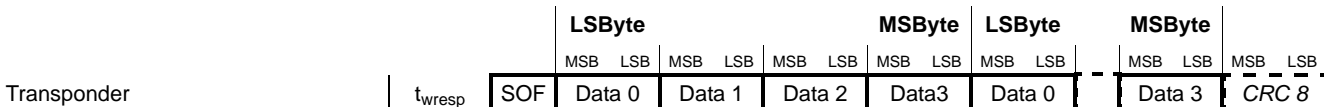
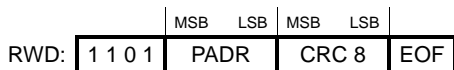

Table 24

RESPONSE PROTOCOL MODE	SOF	CRC8	CODING	DATA RATE
Standard	'1'	no	MC	4 kBit/s
Advanced	'111111'	yes	MC	4 kBit/s
Fast Advanced	'111111'	yes	MC	8 kBit/s

HITAG S

HTS IC H32/HTS IC H56/HTS IC H48

11.9 WRITE PAGE

After a HITAG S Transponder was selected by the corresponding SELECT (UID) command (or SELECT (UID) and CHALLENGE for Authentication Mode) a write operation of data onto the memory can be carried out. Least significant Byte is always transmitted first. E.g. in order to change the configuration page the byte Con0 would have to be transmitted first.

After transmitting the WRITE PAGE command, the Page address PADR (8 Bits) and the 8 Bit Cyclic Redundancy Check (CRC 8), the HITAG S Transponder responds with the SOF and an acknowledge (ACK) to confirm the reception of a correct WRITE PAGE command. After the waiting time t_{wsc} the RWD transmits the write data with CRC 8. After the programming time t_{prog} the HITAG S Transponder responds with a SOF and an acknowledge to confirm correct programming.

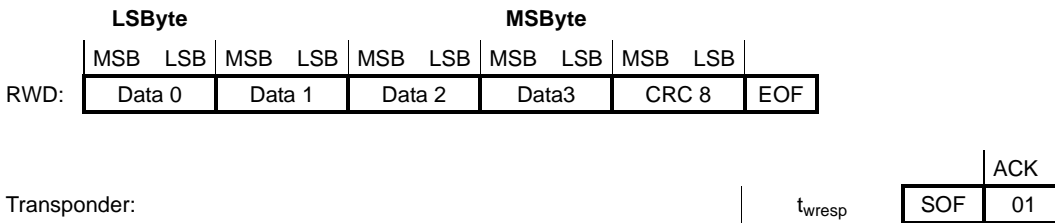
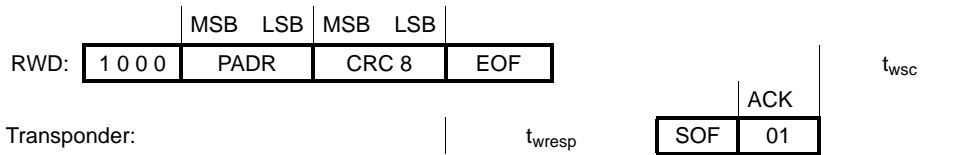

Table 25

RESPONSE PROTOCOL MODE	SOF	CODING	DATA RATE
Standard	'1'	MC	4 kBit/s
Advanced	'111111'	MC	4 kBit/s
Fast Advanced	'111111'	MC	8 kBit/s

HITAG S

HTS IC H32/HTS IC H56/HTS IC H48

11.10 WRITE BLOCK

After transmitting the WRITE BLOCK command, the Page address PADR (8 Bits) within a Block and the 8 Bit Cyclic Redundancy Check (CRC 8), the HITAG S Transponder responds with the SOF and an acknowledge (ACK) to confirm the reception of a correct WRITE BLOCK command. After the waiting time t_{wsc} the RWD transmits the write data with CRC 8 Page by Page (1 to 4 Pages depending on the Page address PADR within the corresponding block). After the programming time t_{prog} the HITAG S Transponder responds with a SOF and an acknowledge to confirm correct programming of each Page.

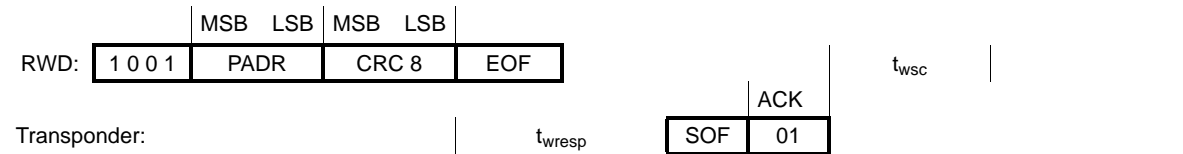

Write Data for Page with Page address: PADR

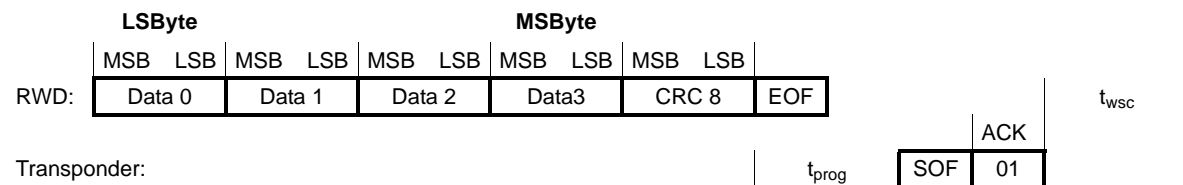

Write Data for Page with Page address: PADR + 1

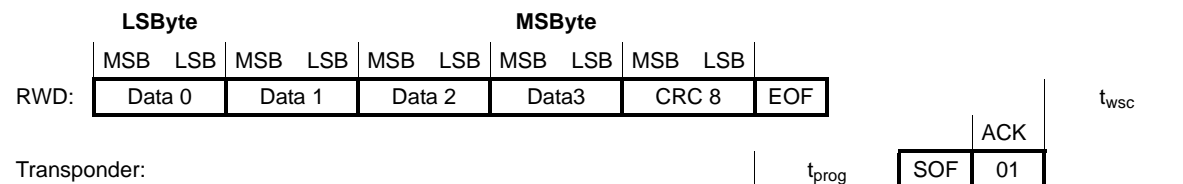

Write Data for Page with Page address: PADR + 2

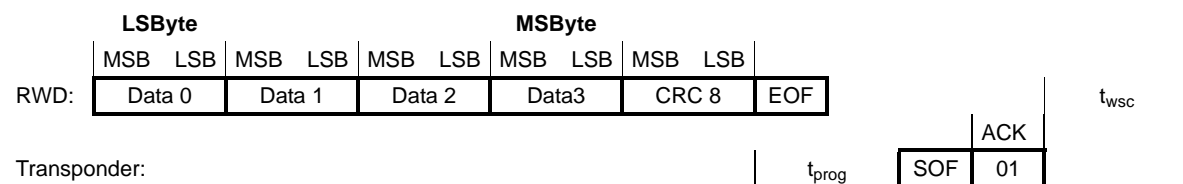

Write Data for Page with Page address: PADR + 3

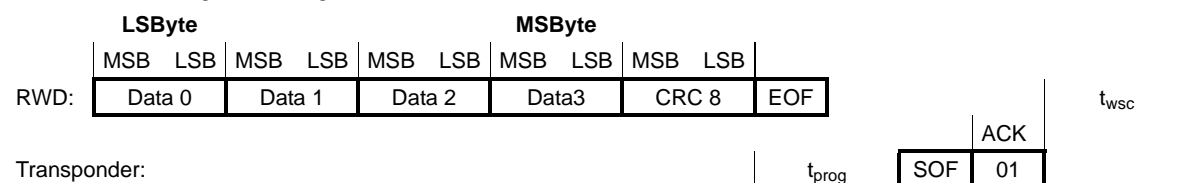

Table 26

RESPONSE PROTOCOL MODE	SOF	CODING	DATA RATE
Standard	'1'	MC	4 kBit/s
Advanced	'111111'	MC	4 kBit/s
Fast Advanced	'111111'	MC	8 kBit/s

HITAG S

HTS IC H32/HTS IC H56/HTS IC H48

11.11 QUIET

With this command a Selected HITAG S Transponder can be entered into the Quiet State.

A valid Page address PADR (8 Bits) and Cyclic Redundancy Check (CRC 8) must be sent for command structure reasons only.

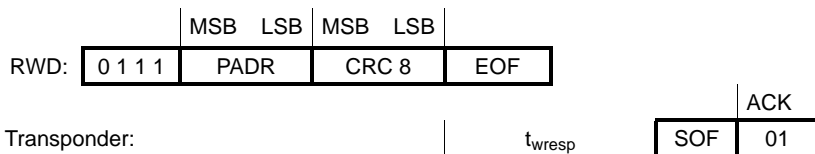

After the response wait time t_{wresp} the HITAG S Transponder responds with a SOF and an acknowledge to confirm entering the Quiet State.

Table 27

RESPONSE PROTOCOL MODE	SOF	CODING	DATA RATE
Standard	'1'	MC	4 kBit/s
Advanced	'111111'	MC	4 kBit/s
Fast Advanced	'111111'	MC	8 kBit/s

A HITAG S Transponder, once entered the Quiet State can only be reactivated after switching off the powering magnetic field for at least a time t_{reset} or the HITAG S Transponder must be moved out of the antenna field (Power Off State).

HITAG S

HTS IC H32/HTS IC H56/HTS IC H48

12 TRANSPONDER TALKS FIRST (TTF) MODE

This special mode of the HITAG S Transponder enables data transmission to a Read/Write Device without sending any command. The TTF Mode can be enabled/disabled and configured by setting the corresponding Bits of the Configuration byte CON 1 (see Chapter 8 "Configuration").

A HITAG S Transponder configured in TTF Mode can be switched temporarily into Reader Talks First (RTF) Mode by sending a UID REQUEST xx command within a defined window after turning on the powering field. The HITAG S Transponder will leave this temporarily RTF Mode after switching off the powering field or moving it out of the RWD antenna field.

If the HITAG S Transponder is configured in TTF Mode and no Mode switch command is sent by the RWD within the defined switch window it enters the TTF State. Depending on the configuration, the HITAG S Transponder transmits the data with different coding, data rate and data length. It is recommended to use some of the data bits as a well defined start sequence.

12.1 32 Bit TTF Mode

Configuration:

TTFM 1	TTFM 0
1	1

In this Mode, the HITAG S Transponder continuously transmits the data content of Page 4.

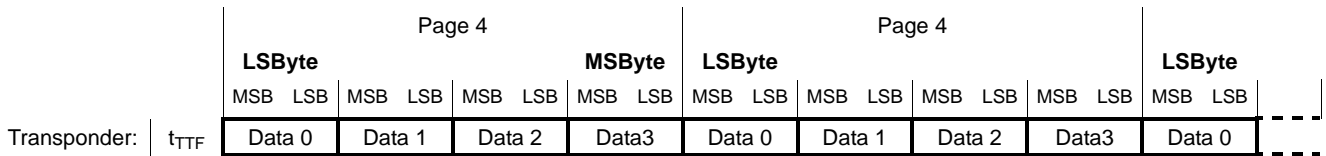

The data rate and the data coding can be chosen independently by configuration Bits TTFC, TTFDR 0 and TTFDR 1.

12.2 64 Bit TTF Mode

Configuration:

TTFM 1	TTFM 0
0	1

In this Mode, the HITAG S Transponder continuously transmits the data content of Page 4 and Page 5.

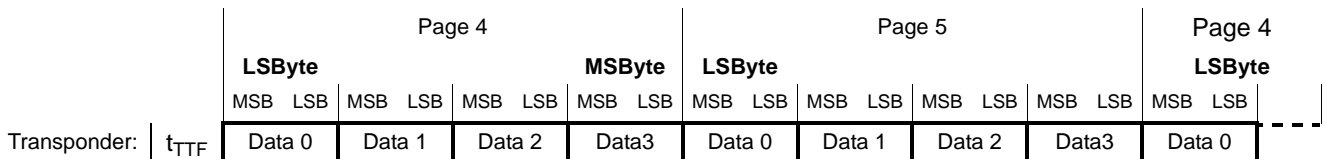

The data rate and the data coding can be chosen independently by configuration Bits TTFC, TTFDR 0 and TTFDR 1.

Note: This Mode may be used for Pigeon race standards.

HITAG S

HTS IC H32/HTS IC H56/HTS IC H48

12.3 128 Bit TTF Mode

Configuration:

TTFM 1	TTFM 0
1	0

In this Mode, the HITAG S Transponder continuously transmits the data content of Page 4, Page 5, Page 6 and Page 7.

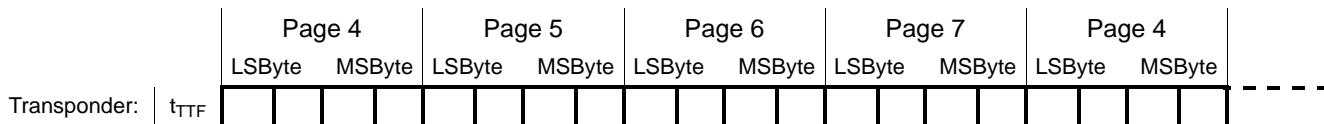

The data rate and the data coding can be chosen independently by configuration Bits TTFC, TTFDR 0 and TTFDR 1.

Note: This Mode may be used for ISO 11784/85 Animal ID standard and German Waste Management standard (BDE) respectively.

HITAG S**HTS IC H32/HTS IC H56/HTS IC H48**

13 DATA INTEGRITY / CALCULATION OF CRC

The following explanations show the features of the HITAG S protocol to protect read and write access to transponders from undetected errors.

13.1 Data Transmission: Read/Write Device to HITAG S Transponder

Every data stream transmitted by the Read/Write Device to the HITAG S Transponder includes an 8 Bit Cyclic Redundancy Check (CRC 8).

The data stream is first checked for data errors by the HITAG S Transponder and then executed.

The generator polynomial for the CRC 8 is:

$$u^8 + u^4 + u^3 + u^2 + 1 = 0x1D$$

The CRC pre set value is: 0xFF

13.2 Data Transmission: HITAG S Transponder to Read/Write Device**13.2.1 STANDARD RESPONSE PROTOCOL MODE**

The HITAG S Transponder response does not include any check sum because of flexibility reasons. To get the data integrity required by the application, check sums have to be calculated by the user software and stored together with the information in the transponder memory. This seems uncomfortable, because the check sums use a little part of the available memory space in the transponder. The advantage of this solution is the flexibility to choose large checksums for applications requiring high data integrity and smaller check sums for applications requiring short access times which means short protocols.

13.2.2 ADVANCED/FAST ADVANCED RESPONSE PROTOCOL MODE

In Advanced – and Fast Advanced Response Protocol Mode the response on a SELECT (UID), CHALLENGE, READ PAGE, READ BLOCK command, includes a CRC 8 check sum.

The generator polynomial for the CRC 8 is:

$$u^8 + u^4 + u^3 + u^2 + 1 = 0x1D$$

The CRC pre set value is: 0xFF

HITAG S

HTS IC H32/HTS IC H56/HTS IC H48

13.3 Source Code for CRC-Checksum

The following lines of C-Code show an example for a CRC-Calculation.

```
#include <stdio.h>

#define CRC_PRESET  0xFF
#define CRC_POLYNOM 0x1D

void calc_crc(unsigned char * crc,
unsigned char data,
unsigned char Bitcount)
{
*crc ^= data;          // crc = crc (exor) data
do
{
if( *crc & 0x80 )      // if (MSB-CRC == 1)
{
*crc<<=1;           // CRC = CRC Bit-shift left
*crc ^= CRC_POLYNOM; // CRC = CRC (exor) CRC_POLYNOM
}
else
{
*crc<<=1;           // CRC = CRC Bit-shift left
}

printf("CRC: %02X ", *crc); // output result step by step
} while(--Bitcount);
printf("\n");
}

void main(void)
{
const cmd=0x00; /* 5 Bit command, aligned to MSB */
const ident[4]={0x2C, 0x68, 0x0D, 0xB4 };

unsigned char crc;
int i;

crc = CRC_PRESET; /* initialize crc algorithm */

calc_crc(&crc, cmd, 5); /* compute 5 crc Bits only */

for(i=0; i<4; i++)
calc_crc(&crc, ident[i], 8);

/* crc = 0x9E at this point */
printf("%02X\n",crc);

getch();
}
```

HITAG S

HTS IC H32/HTS IC H56/HTS IC H48

14 ABBREVIATIONS

ABBREVIATION	DEFINITION
AC	Anticollision Code
ASK	Amplitude Shift Keying
BC	Biphase Code
BPLC	Binary Pulse Length Coding
CRC	Cyclic Redundancy Check
EEPROM	Electrically Erasable Programmable Memory
EOF	End of frame
LSB	Least Significant Bit
LSByte	Least Significant Byte
m	Modulation Index
MC	Manchester Code
MSB	Most Significant Bit
MSByte	Most Significant Byte
NA	No Access
OTP	One Time Programmable
PID	Product Identifier
RND	Random Number
RO	Read Only
RTF	Reader Talks First
R/W	Read/Write
RWD	Read/Write Device
SOF	Start of Frame
TTF	Transponder Talks First
UID	Unique Identifier

HITAG S

HTS IC H32/HTS IC H56/HTS IC H48

15 DATA SHEET STATUS

LEVEL	DATA SHEET STATUS ⁽¹⁾	PRODUCT STATUS ⁽²⁾⁽³⁾	DEFINITION
I	Objective data	Development	This data sheet contains data from the objective specification for product development. Philips Semiconductors reserves the right to change the specification in any manner without notice.
II	Preliminary data	Qualification	This data sheet contains data from the preliminary specification. Supplementary data will be published at a later date. Philips Semiconductors reserves the right to change the specification without notice, in order to improve the design and supply the best possible product.
III	Product data	Production	This data sheet contains data from the product specification. Philips Semiconductors reserves the right to make changes at any time in order to improve the design, manufacturing and supply. Relevant changes will be communicated via a Customer Product/Process Change Notification (CPCN).

Notes

1. Please consult the most recently issued data sheet before initiating or completing a design.
2. The product status of the device(s) described in this data sheet may have changed since this data sheet was published. The latest information is available on the Internet at URL <http://www.semiconductors.philips.com>.
3. For data sheets describing multiple type numbers, the highest-level product status determines the data sheet status.

16 DEFINITIONS

Short-form specification — The data in a short-form specification is extracted from a full data sheet with the same type number and title. For detailed information see the relevant data sheet or data handbook.

Limiting values definition — Limiting values given are in accordance with the Absolute Maximum Rating System (IEC 60134). Stress above one or more of the limiting values may cause permanent damage to the device. These are stress ratings only and operation of the device at these or at any other conditions above those given in the Characteristics sections of the specification is not implied. Exposure to limiting values for extended periods may affect device reliability.

Application information — Applications that are described herein for any of these products are for illustrative purposes only. Philips Semiconductors make no representation or warranty that such applications will be suitable for the specified use without further testing or modification.

17 DISCLAIMERS

Field of Use — Philips owns a worldwide perpetual license for patents US 5,214,409, US 5,499,017, US 5,235,326, and for any foreign counterparts or equivalents of these patents. The license is granted for the Philips Field. The Philips Field covers:

- (a) all non-animal applications and
- (b) any application for animals raised for human consumption (including but not limited to dairy animals), including without limitation livestock and fish.

Please note that the license does not include rights outside the Philips Field, and that Philips does not provide indemnity for the foregoing patents outside the Philips Field. In case you intend to use the product related to this data sheet outside the Philips Field we recommend that you consult a Philips representative for further clarification.

HITAG S

HTS IC H32/HTS IC H56/HTS IC H48

Life support applications — These products are not designed for use in life support appliances, devices, or systems where malfunction of these products can reasonably be expected to result in personal injury. Philips Semiconductors customers using or selling these products for use in such applications do so at their own risk and agree to fully indemnify Philips Semiconductors for any damages resulting from such application.

Right to make changes — Philips Semiconductors reserves the right to make changes in the products - including circuits, standard cells, and/or software - described or contained herein in order to improve design and/or performance. When the product is in full production (status 'Production'), relevant changes will be communicated via a Customer Product/Process Change Notification (CPCN). Philips Semiconductors assumes no responsibility or liability for the use of any of these products, conveys no licence or title under any patent, copyright, or mask work right to these products, and makes no representations or warranties that these products are free from patent, copyright, or mask work right infringement, unless otherwise specified.

HITAG S

HTS IC H32/HTS IC H56/HTS IC H48

18 REVISION HISTORY

Table 28 HTS IC H32/HTS IC H56/HTS IC H48 Revision History

REVISION	DATE	CPCN	PAGE	DESCRIPTION
1.0	2002 August	-		Initial version.
1.1	2002 October	-	Complete Document 29 to 33	Contents updated. Public Mode changed into Plain Mode. Data Rate corrected for Manchester Coding. Delivery Configuration added.
1.2	2003 January	-	17 24 to 30	Contents updated. Values for modulation details completed. Chapter 9 "Protocol timing" modified and final timing parameters added.
2.0	2003 Sept	-	8 24 to 30	Contents updated. Status now -> Preliminary specification added new Section 6.1.1 "Product identifier (PID)" Timing parameter updated.
3.0	2003 Nov	-	3 3	Contents updated. Status now -> Product specification Section 1.1 "Protocol" - added new bullet: "Fast Anticollision Protocol ..." Section 1.3 "Supported Standards" - rewording
3.1	2006 Jul	-	48	Section 17 - added: Patent information, Field of Use

Philips Semiconductors – a worldwide company

Contact information

For additional information please visit <http://www.semiconductors.philips.com>. Fax: +31 40 27 24825

For sales offices addresses send e-mail to: sales.addresses@www.semiconductors.philips.com.

© Koninklijke Philips Electronics N.V. 2002

SCA74

All rights are reserved. Reproduction in whole or in part is prohibited without the prior written consent of the copyright owner.

The information presented in this document does not form part of any quotation or contract, is believed to be accurate and reliable and may be changed without notice. No liability will be accepted by the publisher for any consequence of its use. Publication thereof does not convey nor imply any license under patent- or other industrial or intellectual property rights.

Let's make things better.

Philips
Semiconductors



PHILIPS



Стандарт Электрон Связь

Мы молодая и активно развивающаяся компания в области поставок электронных компонентов. Мы поставляем электронные компоненты отечественного и импортного производства напрямую от производителей и с крупнейших складов мира.

Благодаря сотрудничеству с мировыми поставщиками мы осуществляем комплексные и плановые поставки широчайшего спектра электронных компонентов.

Собственная эффективная логистика и склад в обеспечивает надежную поставку продукции в точно указанные сроки по всей России.

Мы осуществляем техническую поддержку нашим клиентам и предпродажную проверку качества продукции. На все поставляемые продукты мы предоставляем гарантию .

Осуществляем поставки продукции под контролем ВП МО РФ на предприятия военно-промышленного комплекса России , а также работаем в рамках 275 ФЗ с открытием отдельных счетов в уполномоченном банке. Система менеджмента качества компании соответствует требованиям ГОСТ ISO 9001.

Минимальные сроки поставки, гибкие цены, неограниченный ассортимент и индивидуальный подход к клиентам являются основой для выстраивания долгосрочного и эффективного сотрудничества с предприятиями радиоэлектронной промышленности, предприятиями ВПК и научно-исследовательскими институтами России.

С нами вы становитесь еще успешнее!

Наши контакты:

Телефон: +7 812 627 14 35

Электронная почта: sales@st-electron.ru

Адрес: 198099, Санкт-Петербург,
Промышленная ул, дом № 19, литера Н,
помещение 100-Н Офис 331