

MAXIM

MAX9205 Evaluation Kit

General Description

The MAX9205 evaluation kit (EV kit) is a fully assembled and tested circuit board that simplifies the evaluation of the MAX9205 400Mbps, 10-bit serializer and the MAX9206 400Mbps, 10-bit deserializer. The MAX9205 IC transforms 10-bit parallel LVCMOS/LVTTL data into a serial high-speed bus low-voltage differential signaling (BLVDS) data stream. The MAX9206 accepts serial data from the MAX9205 and transforms it back to 10-bit-wide LVCMOS/LVTTL parallel data.

The EV kit requires a single 3.3V supply and a reference clock input with a range of 16MHz to 40MHz to operate. The 10-bit parallel input data is connected to a 24-pin header and the output data is sampled at a separate 24-pin header. The EV kit circuit can be modified to isolate and evaluate the MAX9205 and MAX9206 independently. The MAX9205 and MAX9206 serializer/deserializer pair can be replaced with the MAX9207 and MAX9208 serializer/deserializer pair that operates at a higher maximum data-transfer speed of 600Mbps with a clock input frequency of 40MHz to 60MHz.

Features

- ◆ 3.3V Single Supply
- ◆ 10-Bit Parallel LVCMOS/LVTTL Interface
- ◆ Allows Common-Mode Testing
- ◆ Independent Evaluation of Serializer (MAX9205) and Deserializer (MAX9206)
- ◆ Allows Testing of Twisted-Pair Cable
- ◆ Low-Voltage, Low-Power Operation
- ◆ Fully Assembled and Tested

Ordering Information

PART	TEMP RANGE	IC PACKAGE
MAX9205EVKIT	0°C to +70°C	28 SSOP

Component List

DESIGNATION	QTY	DESCRIPTION
C1-C4	4	10 μ F \pm 20%, 10V tantalum capacitors (B) AVX TAJB106M010 or Kemet T494B106K010AS
C5-C11, C40	7	0.001 μ F \pm 5%, 50V ceramic capacitors (0603) TDK C1608X7R1H102KT or Murata GRM39X7R102J050AD
C12-C18, C21-C25, C39, C41	14	0.1 μ F \pm 10%, 16V ceramic capacitors (0603) TDK C1608X7R1C104KT or Murata GRM39X7R104K016AD
C19, C20	2	5.0pF, 50V COG ceramic capacitors (0603) TDK C1608COG1H050CT Murata GRM39COG050B050AD
C26	1	2.2 μ F \pm 20%, 10V tantalum capacitor (A) AVX TAJA225M010R

DESIGNATION	QTY	DESCRIPTION
C27-C38	12	10pF, 50V COG ceramic capacitors (0603) TDK C1608COG1H100DT or Murata GRM39COG100D050AD
J1, J2	2	2 x 12-pin headers
JU1, JU3-JU7	6	3-pin headers
JU2, JU9, JU10, JU12-JU27	19	2-pin headers
R1-R10, R97	11	10k Ω \pm 5% resistors (0603)
R11-R20, R79-R89, R91-R95	0	Not installed, resistor (0603)
R21-R39, R96	20	49.9 Ω \pm 1% resistors (0603)
R40	1	100 Ω \pm 1% resistor (0603)
R41-R50, R75	0	Not installed, resistor (0805)
R51, R52	0	Not installed, resistor (1206)
R53-R74, R77, R78	24	499 Ω \pm 1% resistors (0603)

MAX9205 Evaluation Kit

Component List (cont'd)

DESIGNATION	QTY	DESCRIPTION
SYNC2, PWRDN1, DEN, PWRDN2, REN	0	Not installed, SMA PC-mount edge connector
TCLK, REFCLK, INA, INB	4	SMA PC-mount edge connectors
U1	1	MAX9205EAI (28-pin SSOP)
U2	1	MAX9206EAI (28-pin SSOP)
U3	1	Buffer/driver three-state output (48-pin TSSOP) Texas Instruments SN74ALVTH16244DGG
None	6	Shunts (JU1, JU3–JU7)
None	1	MAX9205 PC board
None	1	MAX9205 data sheet
None	1	MAX9205 EV kit data sheet

Quick Start

The MAX9205 EV kit is a fully assembled and tested surface-mount board. Follow the steps below for EV kit circuit board operation. **Do not turn on power supply or enable the function generators until all connections are completed.**

Recommended Equipment

- 3.3VDC power supply
- Data generator for LVCMOS/LVTTL 10-bit parallel signal input (e.g., Tektronix DG2020)
- Clock pulse generator (e.g., HP 8130A)
- Logic analyzer or data-acquisition system
- High-speed oscilloscope

Procedure

- 1) Verify that there is a shunt across pins 1 and 2 of jumpers JU1 and JU3–JU7.
- 2) Verify that JU2 does not have a shunt.
- 3) Connect the 3.3V power supply to VCC1. Connect the ground terminal of this supply to GND1.
- 4) Connect the data generator to the 24-pin connector J1 and set it to generate 10-bit parallel data at LVCMOS/LVTTL levels (high-level input from 2.0V to VCC and low-level input from 0.8V to GND). See Table 2 for input bit locations.
- 5) Connect the pulse generator to SMA connector TCLK and set it for an output with a frequency of

Part Selection Table

PART	TYPE	REF CLOCK RANGE (MHz)	SERIAL DATA TRANSFER RATE (Mbps) (max)
MAX9205EAI	Serializer	16 to 40	400
MAX9206EAI	Deserializer	16 to 40	400
MAX9207EAI	Serializer	40 to 60	600
MAX9208EAI	Deserializer	40 to 60	600

16MHz to 40MHz. Use LVCMOS/LVTTL levels. Note that the TCLK SMA connector is terminated with a 50Ω resistor. Synchronize the pulse generator with the data generator.

- 6) Set the data-acquisition system for LVCMOS/LVTTL-level signal input.
- 7) Connect the data-acquisition system to the signal output 24-pin connector J2. See Table 2 for output bit locations.
- 8) Turn on the power supply.
- 9) Enable the pulse generator.
- 10) Enable the data generator.
- 11) Enable the data-acquisition system and begin sampling data.

Detailed Description

The MAX9205 EV kit is a fully assembled and tested circuit board that simplifies the evaluation of the MAX9205 400Mbps maximum data transfer rate, 10-bit serializer and the MAX9206 400Mbps maximum data transfer rate, 10-bit deserializer. The serializer/deserializer data transfer starts with the serializer initially locking onto the reference clock and then sending synchronizing patterns to the deserializer. Once the deserializer locks onto the embedded clock in the patterns, it pulls the SYNC pin low on the serializer, signaling that it is ready to receive the serial data. The serializer transforms the LVCMOS/LVTTL-level 10-bit parallel data pattern into a serial high-speed BLVDS data stream. The interconnect is terminated with 100Ω at each end of the differential bus for a total 50Ω load. The MAX9206 deserializer accepts the serial data from the MAX9205 and transforms it back to 10-bit-wide LVCMOS/LVTTL parallel data.

The EV kit requires a single 3.3V supply to operate and a reference clock input in the 16MHz to 40MHz range. The 10-bit parallel input data can be supplied to the 24-pin header J1 with a data generator running at the

MAX9205 Evaluation Kit

same frequency as the reference clock or the bits can be configured by installing shunts across header J1 pins. The output 10-bit parallel data can be sampled at 24-pin header J2 or individual bits can be tested at the various 2-pin headers installed on the EV kit.

The EV kit circuit can be modified to isolate and evaluate the MAX9205 and MAX9206 independently. While isolated, the serializer's output can be verified with a differential probe or connected to category-5 twisted-pair cable. The deserializer's required LVDS input can be supplied to the EV kit through category-5 twisted-pair wire or SMA connectors.

The MAX9205 and MAX9206 serializer/deserializer pair can be replaced with the MAX9207 and MAX9208 pair for a higher maximum transfer speed rate of 600Mbps with a maximum clock frequency of 60MHz.

Power Supplies

The MAX9205 EV kit operates from a single 3.3V power supply. The serializer and deserializer power and ground planes are connected with PC board traces through resistor pads R49 and R50. The EV kit circuit can be divided into two independent circuits, a serializer and deserializer circuit with dedicated power and ground planes, by cutting open the PC board shorting traces at resistor pads R49 and R50. If the EV kit circuit is divided into two separate circuits, each circuit requires a 3.3V power supply connected at VCC1 (serializer circuit) and VCC2 (deserializer circuit). Independent power and ground planes allow measurements of the deserializer's response to ground shift or other common-mode effects. See the *Serializer/Deserializer Circuits* section.

Clock Signal

The MAX9205 EV kit requires a square-wave LVCMOS/LVTTL input clock signal with a frequency in the 16MHz to 40MHz range. The clock signal can be connected to the TCLK SMA connector or to pin 24 in 24-pin header J1. For faster data transfer rates, replace the MAX9205 (U1) and MAX9206 (U2) serializer/deserializer pair with the MAX9207/MAX9208 serializer/deserializer pair and supply a clock signal with a frequency of 40MHz to 60MHz. During independent evaluation of the serializer and deserializer, supply a clock signal to each circuit. See the *Serializer/Deserializer Circuits* section. The clock input signal to the serializer and deserializer can be monitored at 2-pin headers JU14 and JU15. See Table 1 for details.

Input Signal

The MAX9205 EV kit accepts 10-bit parallel data at LVCMOS/LVTTL levels (high-level input from 2.0V to

Table 1. Clock Signal Monitoring Points

HEADER	SIGNAL	CONNECTOR
JU14	Clock input to serializer	Differential signal probe
JU15	Clock input to deserializer	Differential signal probe

VCC and low-level input from 0.8V to GND). The 10-bit pattern can be supplied to the EV kit by connecting a data generator to the 24-pin header J1 or by pulling selected J1 bit pins to a low LVCMOS/LVTTL state. All the bit pins on J1 are pulled high (VCC1) with 10k Ω pullup resistors installed on the 10 input signal lines. See Table 2 for input bit locations on the 24-pin header J1. If the serializer circuit is operated independently, either the parallel input can be serialized or a sync pin can be driven high to generate sync patterns. If the deserializer is operated independently, a 12-bit serial pattern (10 data bits plus 2 frame bits) must be supplied to the deserializer circuit. Refer to the *Initialization* section in the MAX9206/MAX9208 data sheet for details on the deserializer's input requirements. See the *Serializer/Deserializer Circuits* section for further discussion of independent evaluation.

Output Signal

The MAX9205 EV kit outputs 10-bit parallel data at LVCMOS/LVTTL levels on the 24-pin header J2. To sample the 10-bit pattern, connect an acquisition system to J2 or sample the individual bits with a 2-pin header probe. See Table 2 for the output bits' location on the 24-pin header J2 or Table 3 for the location of the individual output bits. The recovered clock signal is located on pin 23 of J2 and can be used as the external clock input for the acquisition system.

Power-Down Reset

If no output signal is detected from the deserializer, perform a power-down reset on the serializer by momentarily pulling low the PWRDN pin using jumper JU4. (See Table 5 for JU4 operation.)

Serializer/Deserializer Circuits

The MAX9205 EV kit board contains a 10-bit parallel serializer (MAX9205)/deserializer (MAX9206) circuit that only requires a 3.3V input power supply, a 10-bit parallel pattern, an acquisition system, and a clock signal for simple board evaluation. JU2 is provided to test the serializer high-impedance (Z) delay time. The EV kit circuit can be divided into two circuits, a serializer and a deserializer circuit, for independent evaluation. To di-

MAX9205 Evaluation Kit

Table 2. Input/Output Bit Location

SIGNAL	BIT 0	BIT 1	BIT 2	BIT 3	BIT 4	BIT 5	BIT 6	BIT 7	BIT 8	BIT 9
Input/J1	J1-4	J1-6	J1-8	J1-10	J1-12	J1-14	J1-16	J1-18	J1-20	J1-22
Output/J2	J2-1	J2-3	J2-5	J2-7	J2-9	J2-11	J2-13	J2-15	J2-17	J2-19

Table 3. Individual Parallel Outputs

HEADER	BIT/SIGNAL
JU16	0
JU17	1
JU18	2
JU19	3
JU20*	4
JU21*	5
JU22*	6
JU23	7
JU24	8
JU25	9
JU26*	LOCK
JU27*	RCLK

* Headers are not in sequential order on the EV kit board.

vide the circuit into two circuits, cut open the PC board trace shorting the resistor pads at R41–R45, R49, R50, R75, remove resistor R39, and install a shorting resistor on R48.

The MAX9205 (U1) serializer circuit generates two types of signals, synchronization and serialized data patterns:

- 1) Generate synchronization (SYNC) patterns by applying a high-state LVCMOS signal to pin 2 of the 24-pin header J1 or the SYNC2 PC board pad.
- 2) Generate serialized data patterns by asserting a low-state LVCMOS signal to pin 2 of the 24-pin header J1 and provide 10-bit parallel data to the EV kit. For data and clock input signal details, see the *Input Signal* and *Clock Signal* sections, respectively.

The serializer's BLVDS output signal is a 12-bit serial pattern that consists of a high-state start bit and low-state end bit, added internally and used by the deserializer, to the 10-bit parallel input data. Refer to the MAX9205/MAX9207 data sheet for details. To monitor the BLVDS output signal, connect a differential signal probe to JU9 (noninverting single-ended signal) or JU10 (inverting single-ended signal) or connect twisted-pair cable to PC board vias 1A (noninverting signal)

Table 4. LVDS Signals and Connections

SIGNAL	NONINVERTING SIGNAL	INVERTING SIGNAL	CONNECTOR
Serializer (U1) Output	PC board via 1A	PC board via 1B	Plated through holes for twisted-pair (TP) cable
Serializer (U1) Output	Header JU9	Header JU10	Differential signal probe
Deserializer (U2) Input	PC board via 2A (user input)	PC board via 2B (user input)	Plated through holes for TP cable
Deserializer (U2) Input	Header JU12	Header JU13	Differential signal probe

and 1B (inverting signal). Terminate the twisted pair at the far end with a 100Ω resistor for a total 50Ω load. See Table 4 for locations and connector type for the LVDS serial signal output.

To evaluate the MAX9206 (U2) deserializer circuit, provide a 12-bit BLVDS serial input and a clock signal to the REFCLK SMA connector. Bit 0 of the 12-bit serial input pattern should be BLVDS high state and bit 11 should be BLVDS low state with data bit in between. Refer to the MAX9206/MAX9208 data sheet for further details on the start and end bits.

The 12-bit BLVDS pattern can be supplied to the deserializer circuit in two ways: with twisted-pair cable or SMA connectors:

- 1) Using twisted-pair cable, connect the serial input signal to PC board vias 2A (noninverting signal) and 2B (inverting signal). Terminate the twisted-pair cable at the transmitting end with a 100Ω resistor for a total 50Ω load (including the 100Ω resistor in parallel at the deserializer input).
- 2) With SMA connectors, install shorting resistors at the R46 and R47 PC board pads and connect the serial signal through SMA connectors INA (noninverting signal) and INB (inverting signal). Monitor the integri-

MAX9205 Evaluation Kit

Evaluates: MAX9205-MAX9208

Table 5. Jumper Settings

JUMPER	SHUNT STATUS	PIN CONNECTION	EV KIT OPERATION
JU1	1 and 2	TCLK_R/ \bar{F} to VCC1	Serializer data loads on TCLK rising edge
	2 and 3	TCLK_R/ \bar{F} to GND1	Serializer data loads on TCLK falling edge
JU2	Installed	None	Common-mode voltage for serializer high-Z delay test
	Open	None	V _{OS} (offset-voltage probe point)
JU3	1 and 2	DEN to VCC1	Serial data output enabled
	2 and 3	DEN to GND1	Serial data output in high-Z
JU4	1 and 2	\bar{PWRDN} to VCC1	Serializer in normal operation
	2 and 3	\bar{PWRDN} to GND1	Serializer in sleep mode, outputs in high-Z
JU5	1 and 2	REN to VCC2	Deserializer parallel outputs enabled
	2 and 3	REN to GND2	Deserializer ROUT0–ROUT9 and RCLK pins in high-Z, LOCK is active
JU6	1 and 2	\bar{PWRDN} to VCC2	Deserializer in normal operation
	2 and 3	\bar{PWRDN} to GND2	Deserializer outputs (all) in high-Z
JU7	1 and 2	RCLK_R/ \bar{F} to VCC2	Deserializer output data on RCLK rising edge
	2 and 3	RCLK_R/ \bar{F} to GND2	Deserializer output data on RCLK falling edge

Component Suppliers

SUPPLIER	PHONE	FAX	WEBSITE
AVX	843-448-9411	843-448-1943	www.avxcorp.com
Kemet	864-963-6300	864-963-6322	www.kemet.com
Murata	770-436-1300	770-436-3030	www.murata.com
TDK	847-803-6100	847-390-6296	www.component.tdk.com
Texas Instruments	972-644-5580	214-480-7800	www.ti.com

Note: Please indicate that you are using the MAX9205 when contacting these component suppliers.

ty of the LVDS input signal by connecting a differential signal probe to jumpers JU12 (noninverting signal) or JU13 (inverting signal). See Table 4 for locations and connector type for the serial input. To evaluate the output signal of the deserializer, see the *Output Signal* section. If LOCK is not low (check JU26 or J2-23), send 200 or more synchronization patterns to the deserializer to lock onto the serial input.

Jumper Settings

The MAX9205 EV kit circuit contains several jumpers that allow the user to put the serializer and deserializer into several operational modes. See Table 5 for jumper settings and EV kit operation descriptions.

Terminations and Layout

All signal lines are 50Ω controlled-impedance traces. All the differential output signal traces are terminated with 100Ω resistors at each end. Each differential output pair is laid out with equal trace length. The EV kit is laid out as a four-layer board to minimize noise interference.

MAX9205 Evaluation Kit

Evaluates: MAX9205-MAX9208

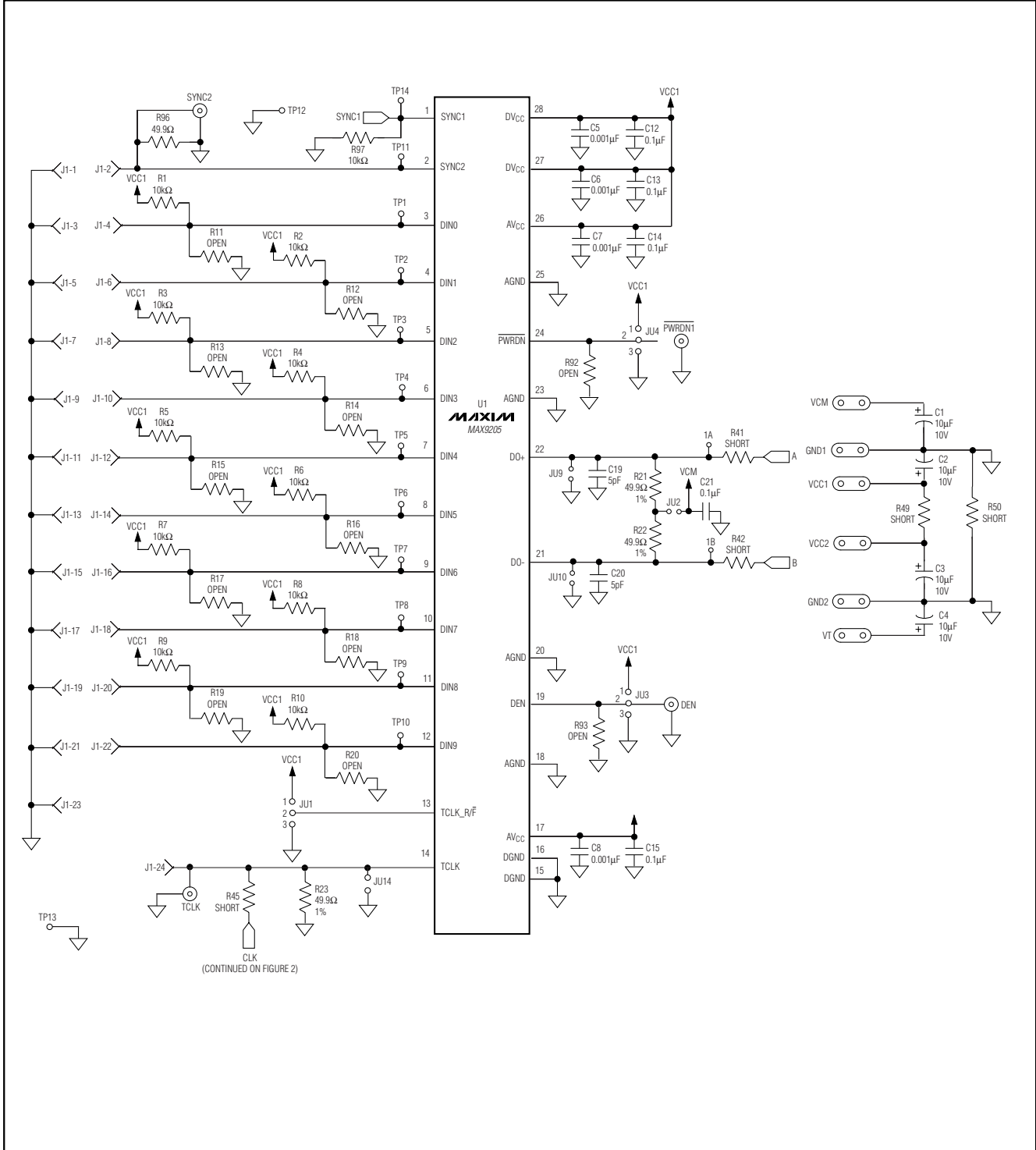

Figure 1. MAX9205 EV Kit Schematic—Serializer

MAX9205 Evaluation Kit

Evaluates: MAX9205-MAX9208

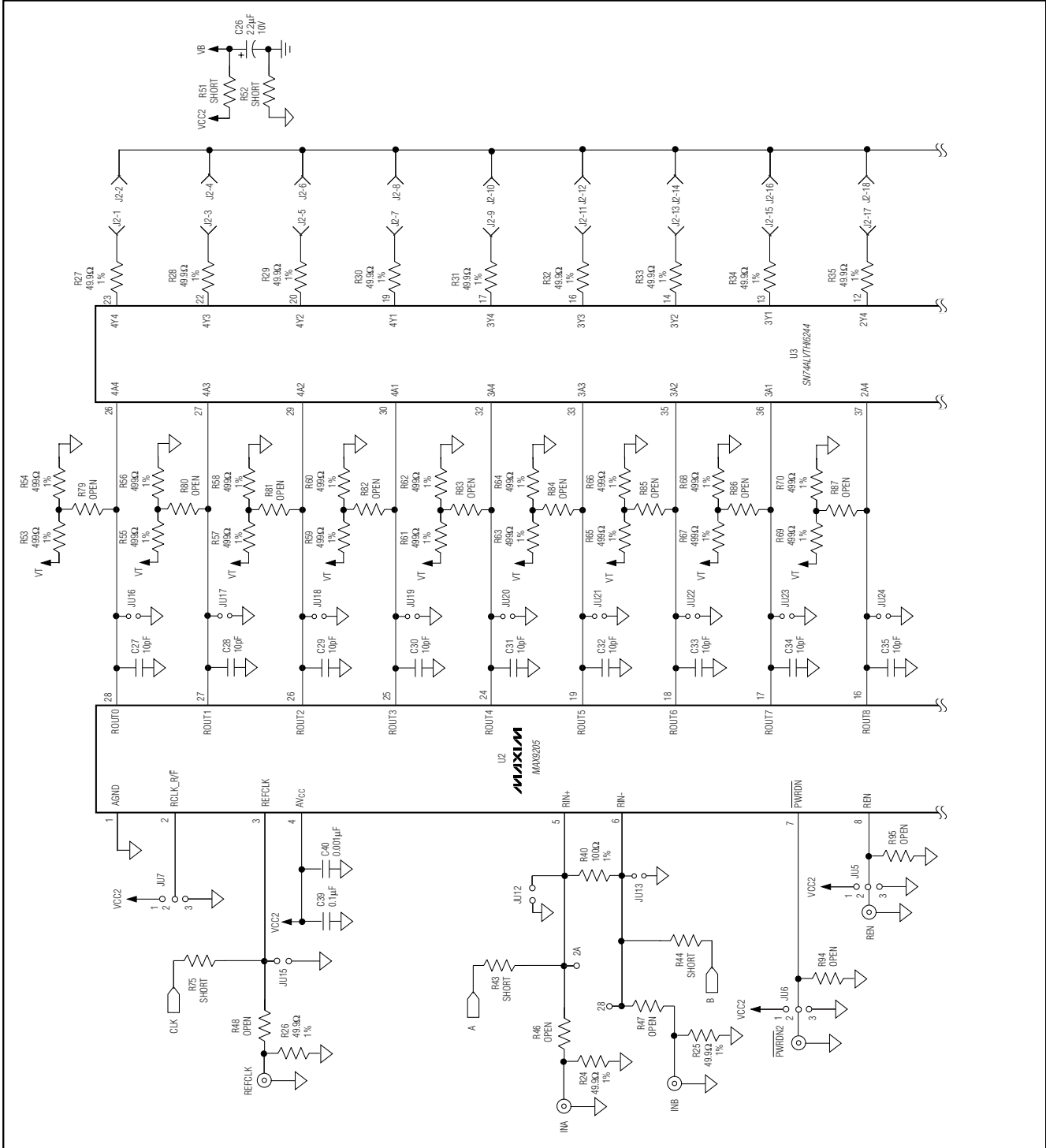

Figure 2. MAX9205 EV Kit Schematic—Deserializer (Sheet 1 of 2)

MAX9205 Evaluation Kit

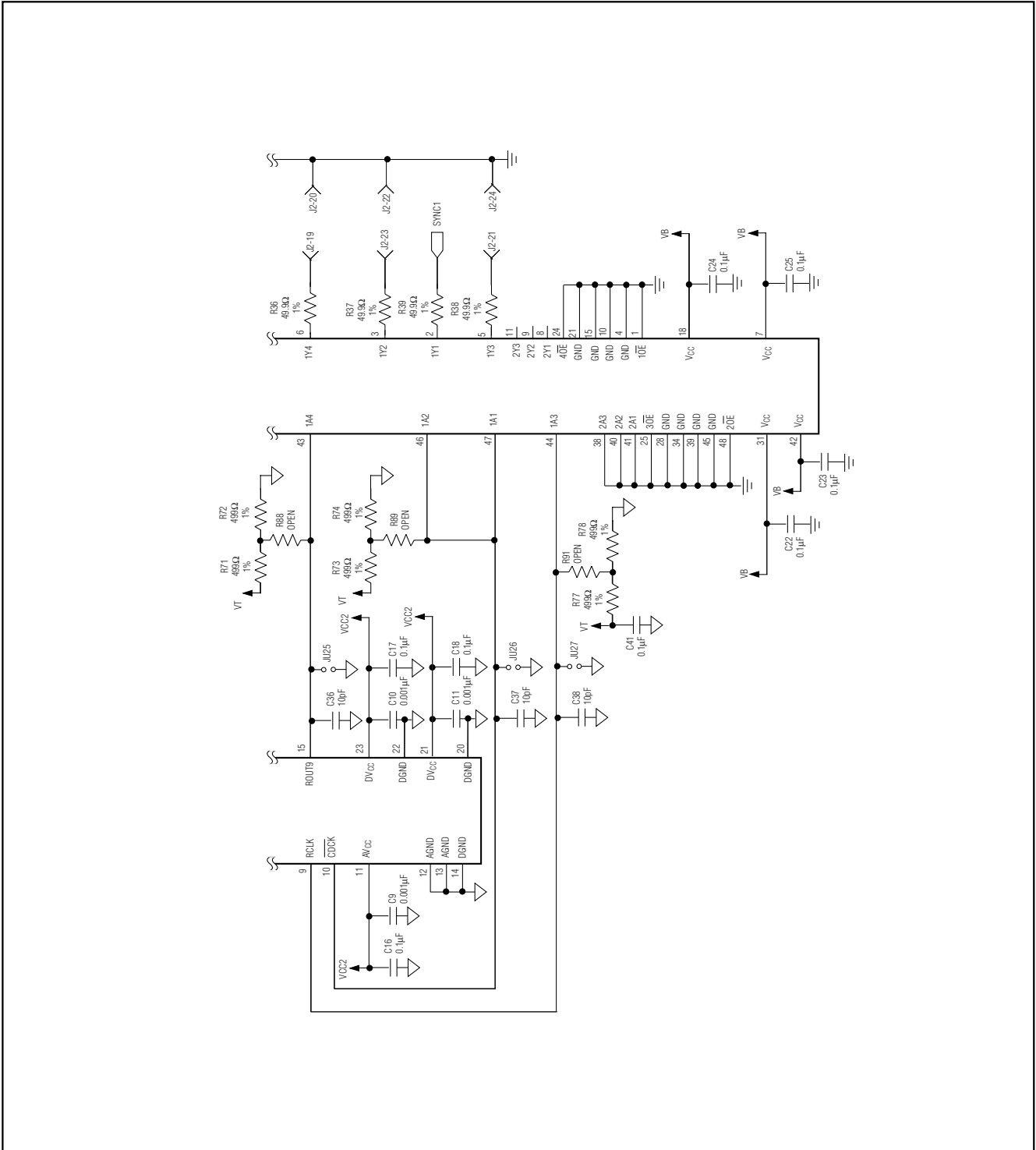

Figure 2. MAX9205 EV Kit Schematic—Deserializer (Sheet 2 of 2)

MAX9205 Evaluation Kit

Evaluates: MAX9205-MAX9208

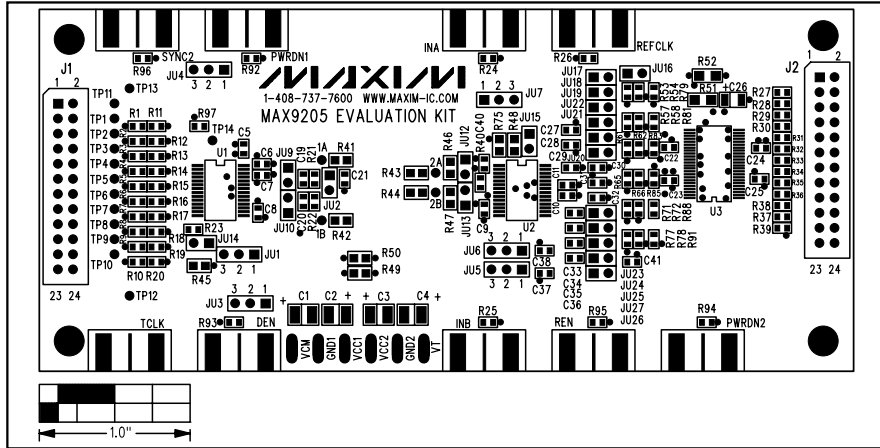

Figure 3. MAX9205 EV Kit Component Placement Guide—Component Side

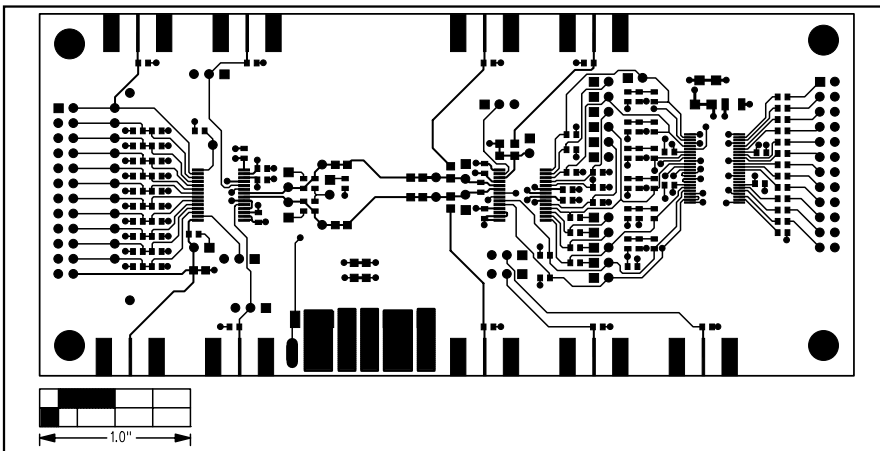

Figure 4. MAX9205 EV Kit PC Board Layout—Component Side

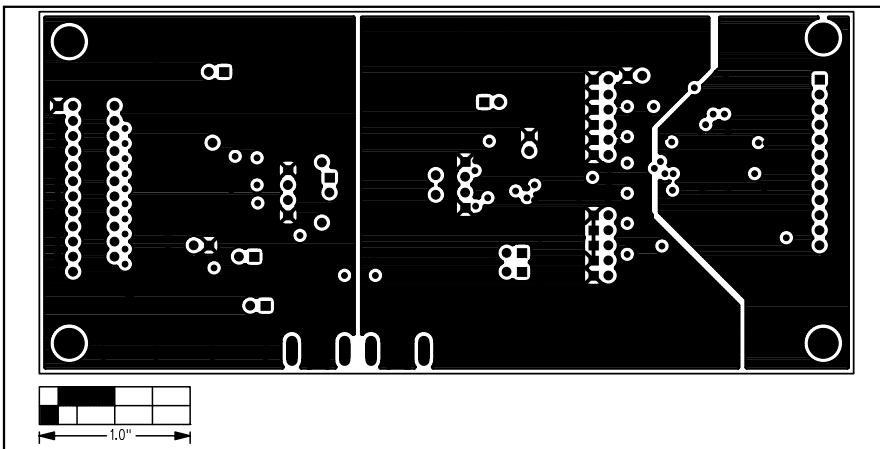

Figure 5. MAX9205 EV Kit PC Board Layout—Ground Planes

MAX9205 Evaluation Kit

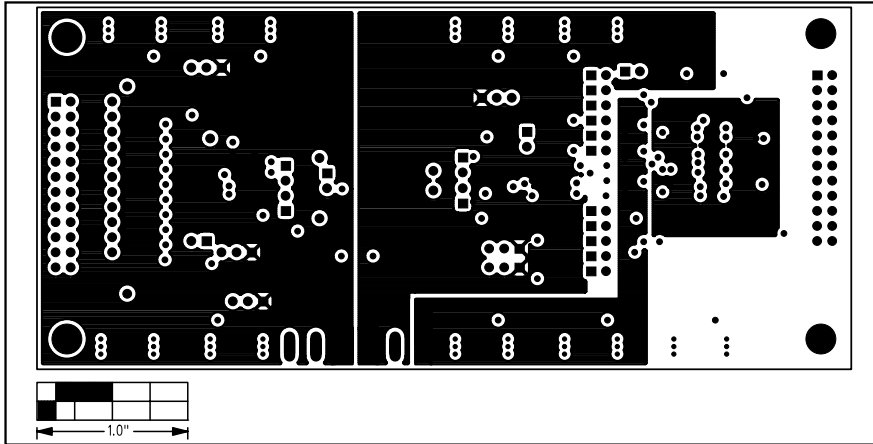

Figure 6. MAX9205 EV Kit PC Board Layout—Power Planes

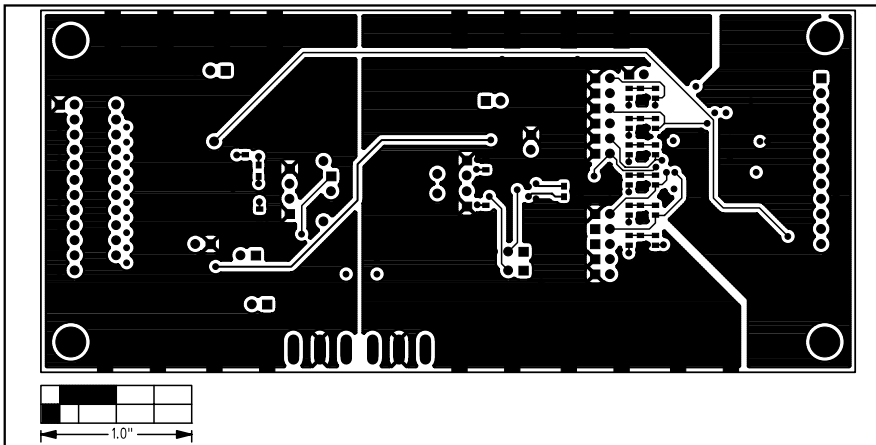

Figure 7. MAX9205 EV Kit PC Board Layout—Solder Side

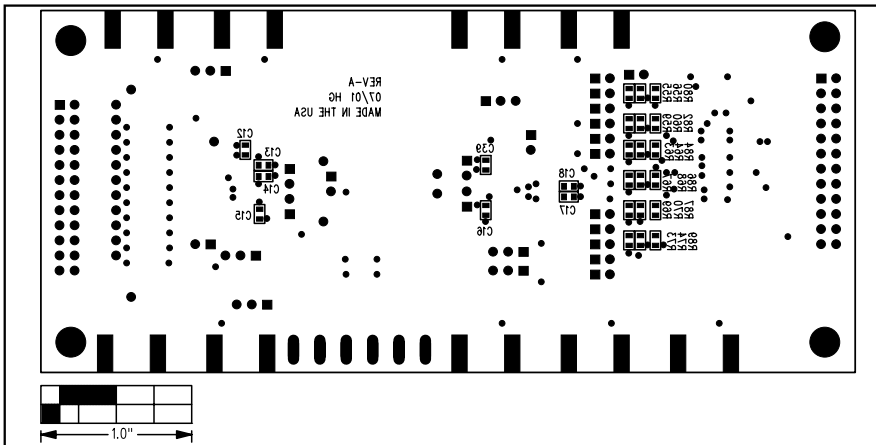

Figure 8. MAX9205 EV Kit Component Placement Guide—Solder Side

Maxim cannot assume responsibility for use of any circuitry other than circuitry entirely embodied in a Maxim product. No circuit patent licenses are implied. Maxim reserves the right to change the circuitry and specifications without notice at any time.

10 **Maxim Integrated Products, 120 San Gabriel Drive, Sunnyvale, CA 94086 408-737-7600**



Стандарт Электрон Связь

Мы молодая и активно развивающаяся компания в области поставок электронных компонентов. Мы поставляем электронные компоненты отечественного и импортного производства напрямую от производителей и с крупнейших складов мира.

Благодаря сотрудничеству с мировыми поставщиками мы осуществляем комплексные и плановые поставки широчайшего спектра электронных компонентов.

Собственная эффективная логистика и склад в обеспечивает надежную поставку продукции в точно указанные сроки по всей России.

Мы осуществляем техническую поддержку нашим клиентам и предпродажную проверку качества продукции. На все поставляемые продукты мы предоставляем гарантию .

Осуществляем поставки продукции под контролем ВП МО РФ на предприятия военно-промышленного комплекса России , а также работаем в рамках 275 ФЗ с открытием отдельных счетов в уполномоченном банке. Система менеджмента качества компании соответствует требованиям ГОСТ ISO 9001.

Минимальные сроки поставки, гибкие цены, неограниченный ассортимент и индивидуальный подход к клиентам являются основой для выстраивания долгосрочного и эффективного сотрудничества с предприятиями радиоэлектронной промышленности, предприятиями ВПК и научно-исследовательскими институтами России.

С нами вы становитесь еще успешнее!

Наши контакты:

Телефон: +7 812 627 14 35

Электронная почта: sales@st-electron.ru

Адрес: 198099, Санкт-Петербург,
Промышленная ул, дом № 19, литера Н,
помещение 100-Н Офис 331