



■ Features :

- DC/DC step-up converter
- Constant current output : 350mA to 1050mA
- Wide output LED string voltage up to 126VDC
- High efficiency up to 95%
- Built-in EMI filter ,comply with EN55015 without additional input filter and capacitors
- PWM + analog dimming and remote ON/OFF control
- Protections: Short circuit / Over voltage / Under voltage
- Cooling by free air convection
- Fully encapsulated
- 3 years warranty



LDH-45 □-350 ○ □=A or B; A: 9~18VDC input range, B: 18~32VDC input range
○=Blank or W; Blank:pin style, W:wire style

SPECIFICATION

MODEL	LDH-45A-350○	LDH-45A-500○	LDH-45A-700○	LDH-45A-1050○	LDH-45B-350○	LDH-45B-500○	LDH-45B-700○	LDH-45B-1050○	
OUTPUT	RATED CURRENT	350mA	500mA	700mA	1050mA	350mA	500mA	700mA	1050mA
	CURRENT ACCURACY(Typ.)	±5% at 12VDC input				±5% at 24VDC input			
	VOLTAGE RANGE Note.3	12~86VDC	12~86VDC	12~64VDC	12~43VDC	21~126VDC	21~86VDC	21~64VDC	21~43VDC
	NO LOAD OUTPUT VOLTAGE(max.)	100V	100V	75V	50V	146V	100V	75V	50V
	RATED POWER	30.1W	43W	44.8W	45.15W	45.15W	43W	44.8W	45.15W
INPUT	RIPPLE & NOISE (max.) Note.2	2.5Vp-p	2.5Vp-p	1.9Vp-p	1.9Vp-p	2.5Vp-p	1.7Vp-p	1.2Vp-p	1.2Vp-p
	RATED VOLTAGE	12VDC				24VDC			
	VOLTAGE RANGE	9~18VDC				18~32VDC			
	EFFICIENCY (max.)	91%	90%	90%	91%	93%	94%	95%	95%
PWM DIMMING & ON/OFF CONTROL	DC CURRENT (Typ.)	2.8A	4.1A	4.2A	4.2A	2.1A	2.1A	2A	2A
	REMOTE ON/OFF	Leave open if not used Power ON with dimming: PWM DIM~DIM- >2~8VDC or open circuit Power OFF : PWM DIM~DIM- <0.5VDC or short or PWM duty is equal to 0%							
	PWM DIMMING FREQUENCY	1K~10KHz							
	QUIESCENT INPUT CURRENT IN SHUTDOWN MODE(Typ.)	7mA at PWM dimming OFF							
ANALOG DIMMING & ON/OFF CONTROL	REMOTE ON/OFF	Leave open if not used Power on with dimming: Analog DIM~DIM- >0.25~8VDC or open circuit Power off : Analog DIM~DIM- <0.2VDC or short							
	DIM INPUT VOLTAGE RANGE	0.25~1.3VDC							
	MAX OPERATION VOLTAGE	8V; The output current remains constant when voltage changes from 1.3V to 8V							
	QUIESCENT INPUT CURRENT IN SHUTDOWN MODE(Typ.)	7mA at Analog dimming OFF							
PROTECTION	SHORT CIRCUIT	Protection type : Power OFF and fuse open							
	OVER VOLTAGE (max.)	100V	100V	75V	50V	146V	100V	75V	50V
ENVIRONMENT	WORKING TEMP.	-40 ~ +70°C (Refer to "Derating Curve")							
	WORKING HUMIDITY	20 ~ 90% RH non-condensing							
	STORAGE TEMP., HUMIDITY	-40 ~ +85°C, 10 ~ 95% RH							
	TEMP. COEFFICIENT	±0.03%/°C (0 ~ 50°C)							
	VIBRATION	10 ~ 500Hz, 2G 10min./1cycle, period for 60min. each along X, Y, Z axes							
EMC	EMC EMISSION	Compliance to EN55015							
	EMC IMMUNITY	Compliance to EN61547, EN61000-4-2,3,4,6,8; light industry level, criteria A							
OTHERS	MTBF	1179.3Khrs min. MIL-HDBK-217F (25°C)							
	DIMENSION	75*53*22.7mm (L*W*H)							
	PACKING	138g;100pcs/14.8Kg/0.83CUFT(Blank Type),1.04CUFT(W Type)							
NOTE	<p>1. All parameters are specified at normal input(12VDC,24VDC), rated load, 25°C 70% RH ambient.</p> <p>2. Ripple & noise are measured at 20MHz of bandwidth by using a 12" twisted pair-wire terminated with a 0.1uf parallel capacitor.</p> <p>3. Output voltage will always step up by 3 Volts from input DC voltage.</p>								

■ Mechanical Specification

LDH (Pin Style):

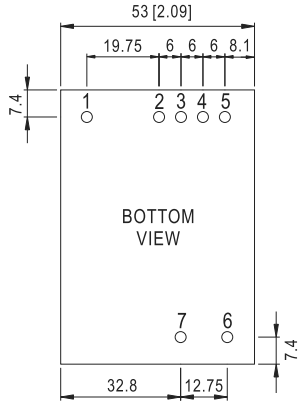

Unit: mm (inch)

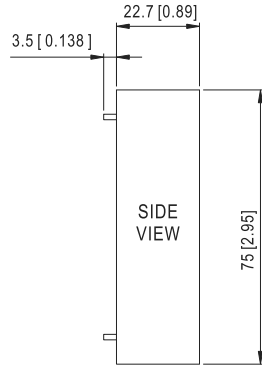

NOTE: Pin size tolerance 1.0 φ ±0.05mm

■ Pin Configuration

Pin No.	Output	Description
1	Vin+	DC Supply
2	Vin-	Don't connect to Vout-
3	DIM-	GND of DIM signal Don't connect to Vout- or Vin-
4	Analog DIM	ON/OFF and analog voltage dimming (leave open if not used)
5	PWM DIM	ON/OFF and PWM dimming (leave open if not used)
6	Vout-	LED - connection
7	Vout+	LED + connection

LDH (Wire Style):

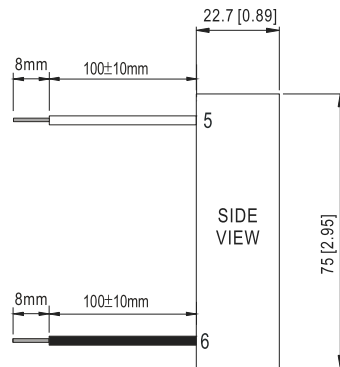
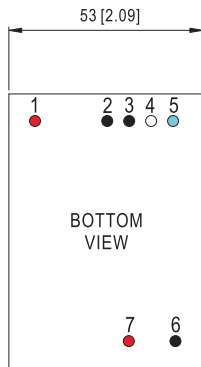

Pin No.	Output	Description
1	Vin+(red)	DC Supply
2	Vin-(black)	Don't connect to Vout-
3	DIM-(black)	GND of DIM signal Don't connect to Vout- or Vin-
4	Analog DIM (white)	ON/OFF and analog voltage dimming (leave open if not used)
5	PWM DIM (blue)	ON/OFF and PWM dimming (leave open if not used)
6	Vout-(black)	LED - connection
7	Vout+(red)	LED + connection

■ Derating Curve

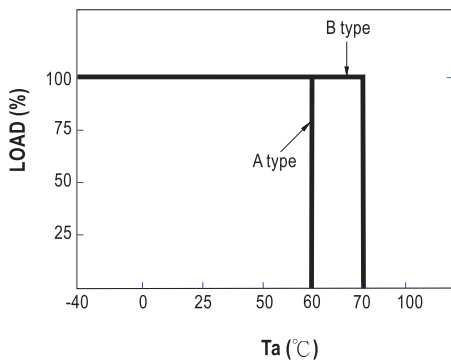

■ Static Characteristics

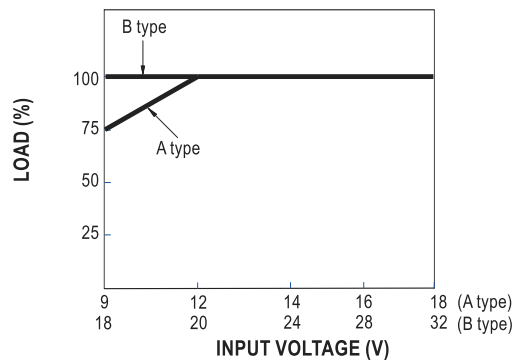

■ Standard Application

Operation without dimming:

I_O operates at rated current without dimming function when the pins of analog DIM and PWM DIM keep open

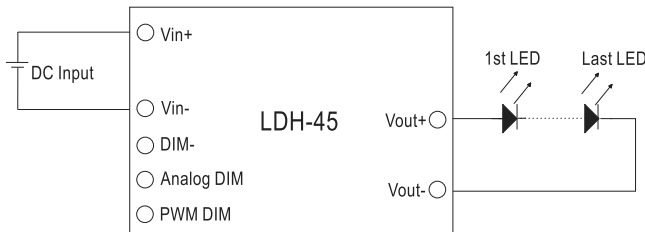

PWM Dimming Control:

I_O adjustment by PWM Signal

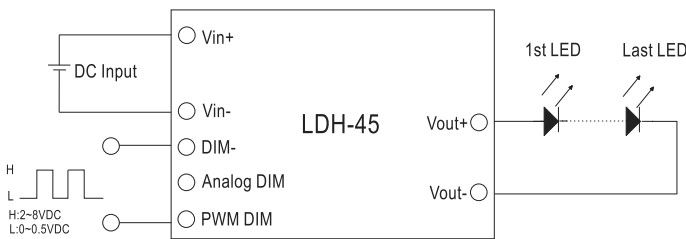

During PWM dimming operation, I_O will change with the PWM duty (PWM Signal: 1K~10KHz)



Analog Dimming Control:

I_O adjustment by DC voltage

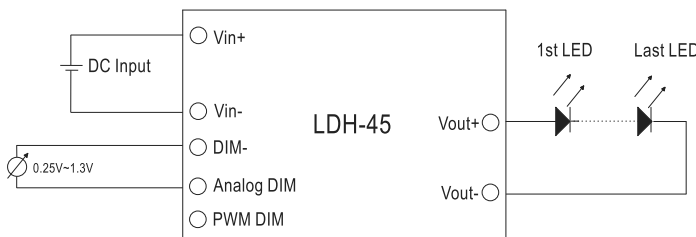

During analog dimming operation, I_O will change with DC input voltage

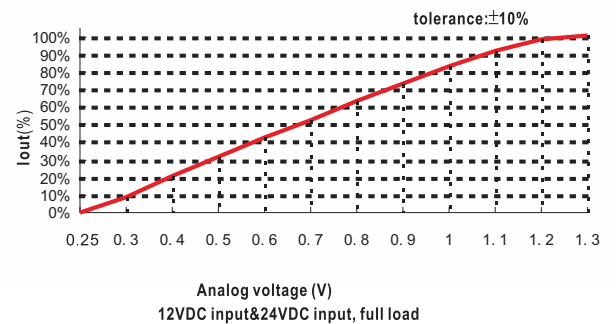

■ Efficiency VS Output Voltage(Number of LEDs)

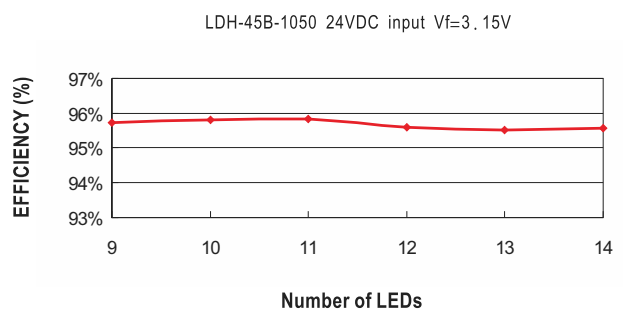
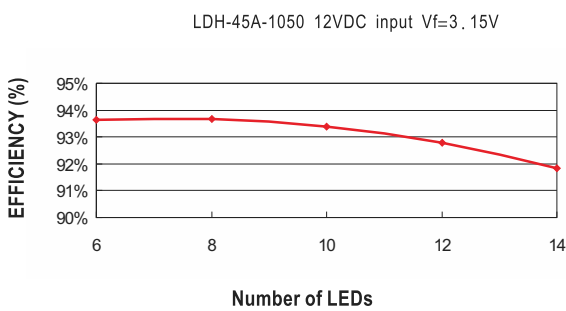
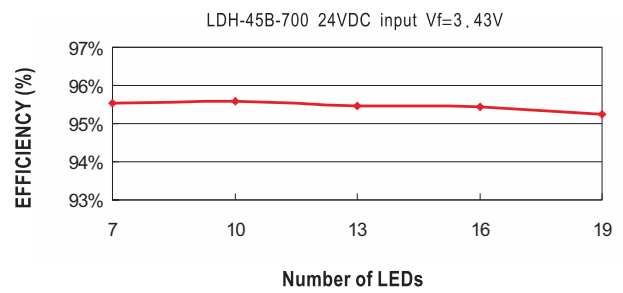
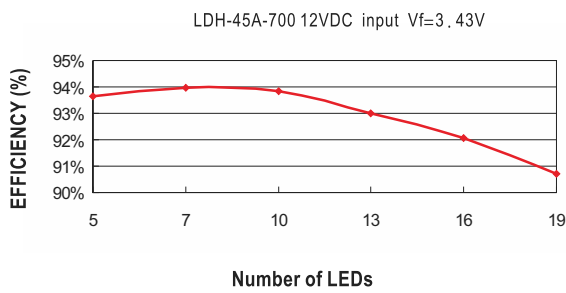
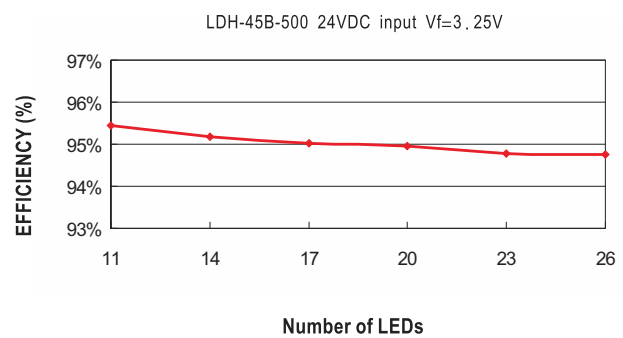
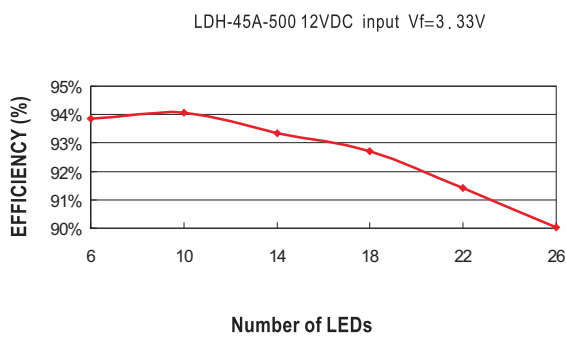
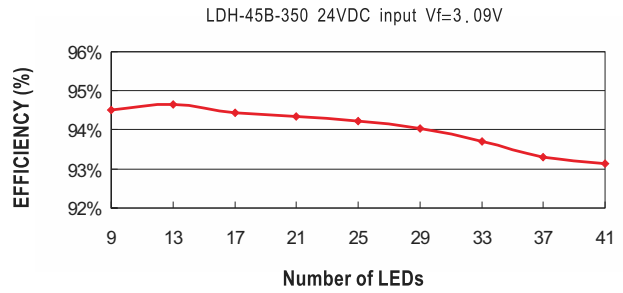
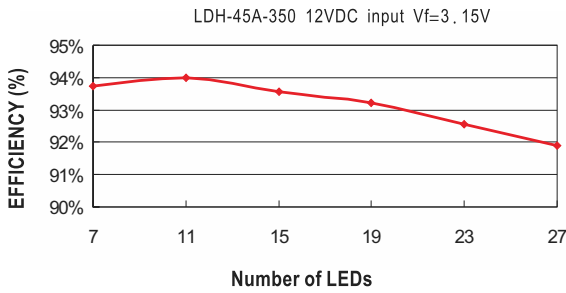



Стандарт Электрон Связь

Мы молодая и активно развивающаяся компания в области поставок электронных компонентов. Мы поставляем электронные компоненты отечественного и импортного производства напрямую от производителей и с крупнейших складов мира.

Благодаря сотрудничеству с мировыми поставщиками мы осуществляем комплексные и плановые поставки широчайшего спектра электронных компонентов.

Собственная эффективная логистика и склад в обеспечивает надежную поставку продукции в точно указанные сроки по всей России.

Мы осуществляем техническую поддержку нашим клиентам и предпродажную проверку качества продукции. На все поставляемые продукты мы предоставляем гарантию .

Осуществляем поставки продукции под контролем ВП МО РФ на предприятия военно-промышленного комплекса России , а также работаем в рамках 275 ФЗ с открытием отдельных счетов в уполномоченном банке. Система менеджмента качества компании соответствует требованиям ГОСТ ISO 9001.

Минимальные сроки поставки, гибкие цены, неограниченный ассортимент и индивидуальный подход к клиентам являются основой для выстраивания долгосрочного и эффективного сотрудничества с предприятиями радиоэлектронной промышленности, предприятиями ВПК и научно-исследовательскими институтами России.

С нами вы становитесь еще успешнее!

Наши контакты:

Телефон: +7 812 627 14 35

Электронная почта: sales@st-electron.ru

Адрес: 198099, Санкт-Петербург,
Промышленная ул, дом № 19, литера Н,
помещение 100-Н Офис 331