

LENA-WAS

Asymmetric beam for wall-washing

TECHNICAL SPECIFICATIONS:

Dimensions	Ø 111.0 mm
Height	37 mm
Fastening	glue
ROHS compliant	yes 

MATERIAL SPECIFICATIONS:

Component	Type	Material	Colour	Finish	Coating
LENA-WAS	Reflector	PC	metal		lacquer





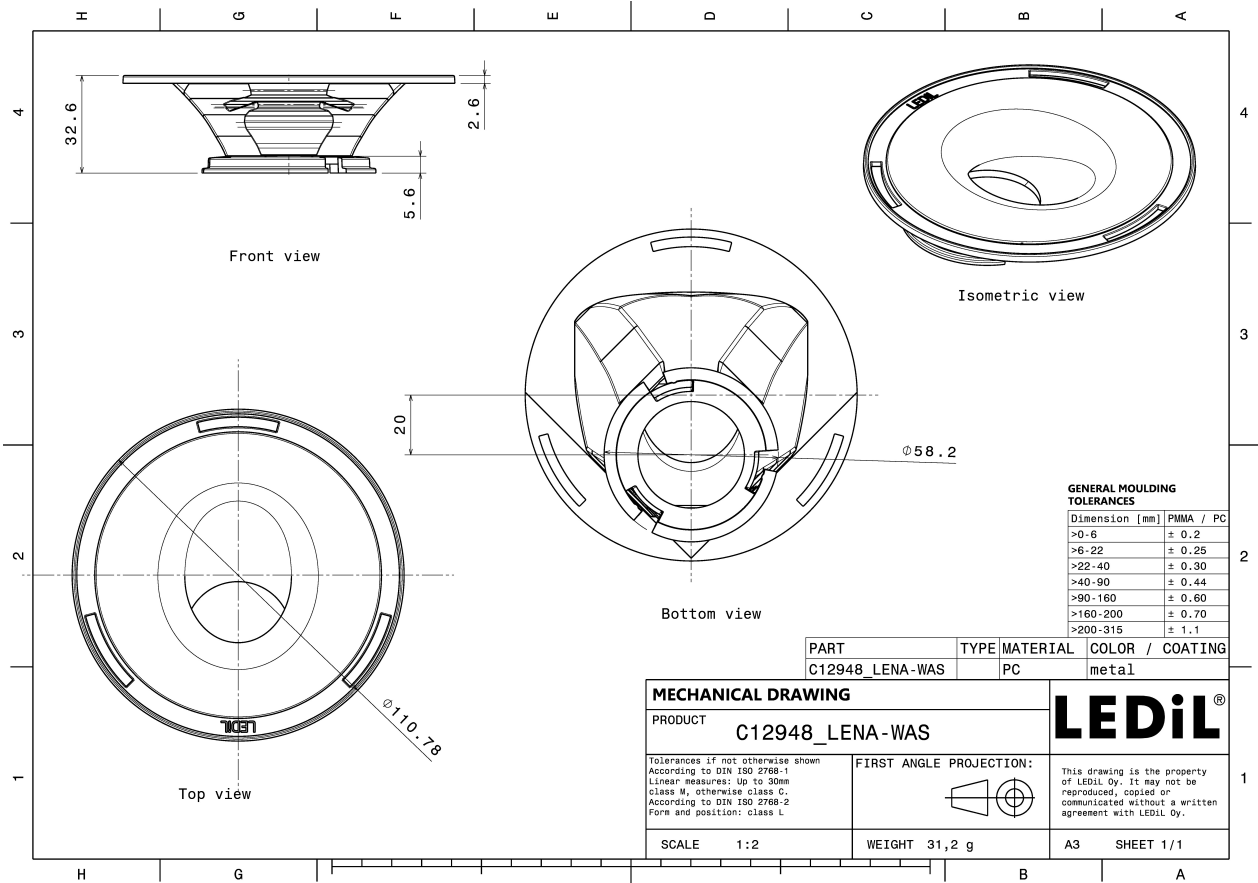

ORDERING INFORMATION:

Component	Qty in box	MOQ	MPQ	Box weight (kg)
C12948_LENA-WAS » Box size: 480 x 280 x 300 mm	56	56	56	3.1

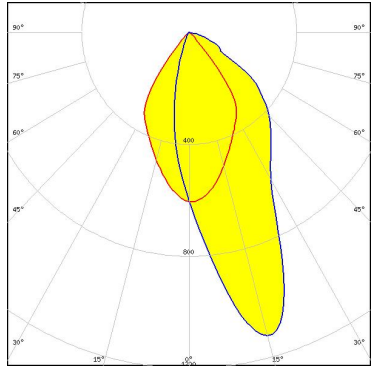
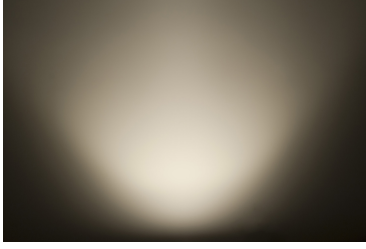
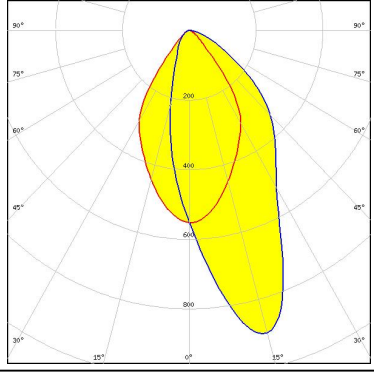

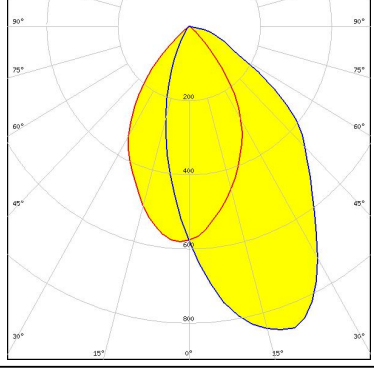
PHOTOMETRIC DATA (MEASURED):

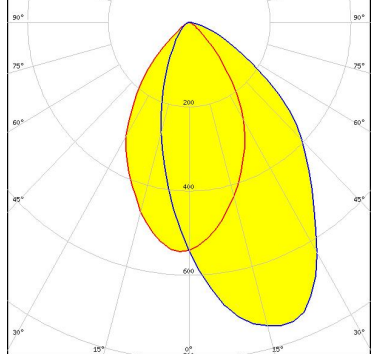
<p>bridgelux.</p> <p>LED BXRA ES Rectangle FWHM Asymmetric Efficiency 80 % Peak intensity 1.1 cd/lm LEDs/each optic 1 Light colour White Required components: C12153_LENA-STD-BASE-BXRA</p>		
<p>bridgelux.</p> <p>LED BXRA ES Rectangle FWHM Asymmetric Efficiency 77 % Peak intensity 0.5 cd/lm LEDs/each optic 1 Light colour White Required components: C12153_LENA-STD-BASE-BXRA C11996_LENA-LENS</p>		
<p>bridgelux.</p> <p>LED BXRA RS FWHM Asymmetric Efficiency 80 % Peak intensity 0.9 cd/lm LEDs/each optic 1 Light colour White Required components: C12229_LENA-STD-BASE-RS</p>		
<p>bridgelux.</p> <p>LED BXRA RS FWHM Asymmetric Efficiency 75 % Peak intensity 0.8 cd/lm LEDs/each optic 1 Light colour White Required components: C12229_LENA-STD-BASE-RS C11996_LENA-LENS</p>		

PHOTOMETRIC DATA (MEASURED):

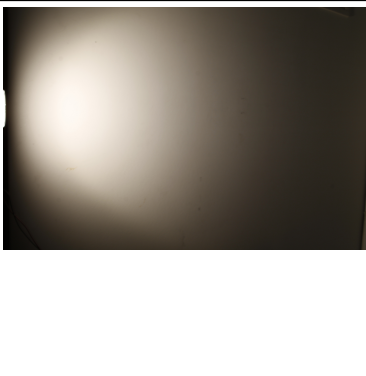
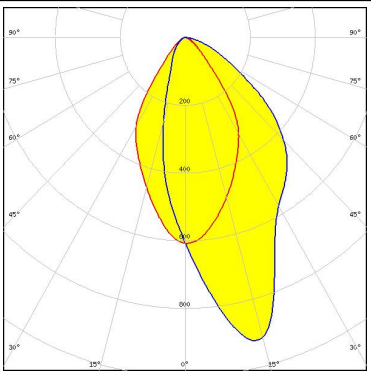
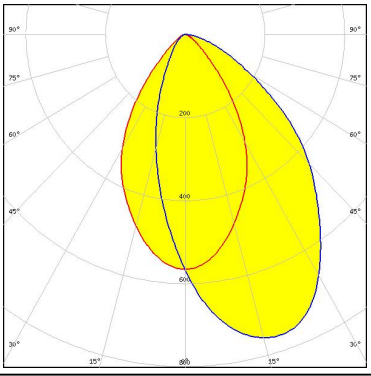
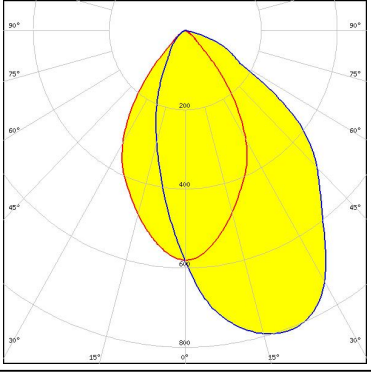
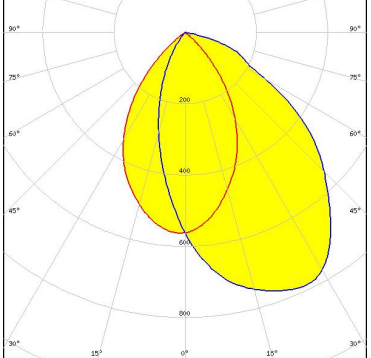
<p>bridgelux.</p> <p>LED V10 Gen6 FWHM Asymmetric Efficiency 83 % Peak intensity 0.9 cd/lm LEDs/each optic 1 Light colour White Required components: C13186_LENA-STD-BASE-CXA15 C11996_LENA-LENS</p>		
<p>bridgelux.</p> <p>LED V22 Gen7 FWHM Asymmetric Efficiency 82 % Peak intensity 0.8 cd/lm LEDs/each optic 1 Light colour White Required components: C13867_LENA-STD-BASE-VERO29 C11996_LENA-LENS Bender Wirth: 431 Typ L3</p>		
<p>bridgelux.</p> <p>LED V22 Gen7 FWHM Asymmetric Efficiency 84 % Peak intensity 0.8 cd/lm LEDs/each optic 1 Light colour White Required components: C13867_LENA-STD-BASE-VERO29 C14169_LENA-CLEAR-LENS Bender Wirth: 431 Typ L3</p>		
<p>bridgelux.</p> <p>LED Vero SE 29 FWHM Asymmetric Efficiency 87 % Peak intensity 0.8 cd/lm LEDs/each optic 1 Light colour White Required components: C15083_LENA-STD-BASE-VERO29</p>		

PHOTOMETRIC DATA (MEASURED):

<p>bridgelux.</p> <p>LED VERO13 FWHM Asymmetric Efficiency 91 % Peak intensity 1.3 cd/lm LEDs/each optic 1 Light colour White Required components: C13868_LENA-STD-BASE-VERO13-18</p>	
<p>bridgelux.</p> <p>LED VERO13 FWHM Asymmetric Efficiency 87 % Peak intensity 0.5 cd/lm LEDs/each optic 1 Light colour White Required components: C13868_LENA-STD-BASE-VERO13-18 C11996_LENA-LENS</p>	
<p>bridgelux.</p> <p>LED VERO13 FWHM Asymmetric Efficiency 87 % Peak intensity 1.1 cd/lm LEDs/each optic 1 Light colour White Required components: C13868_LENA-STD-BASE-VERO13-18 C11996_LENA-LENS</p>	
<p>bridgelux.</p> <p>LED VERO18 FWHM Asymmetric Efficiency 90 % Peak intensity 1.1 cd/lm LEDs/each optic 1 Light colour White Required components: C13868_LENA-STD-BASE-VERO13-18</p>	

PHOTOMETRIC DATA (MEASURED):

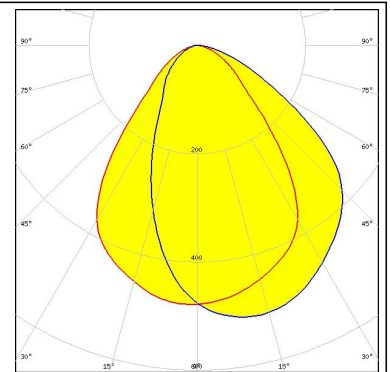
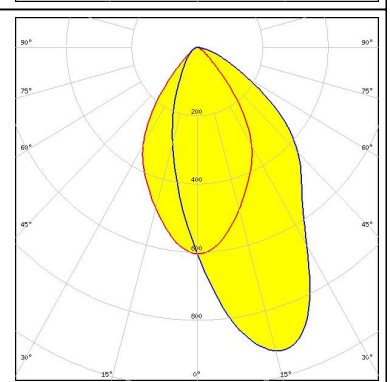
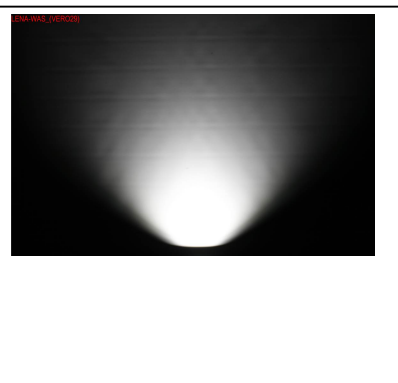
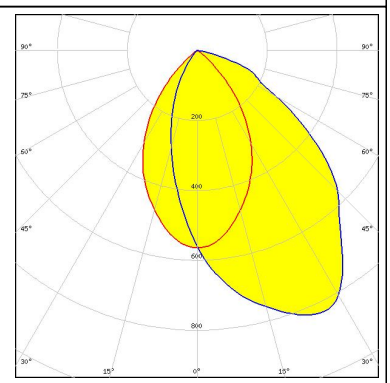
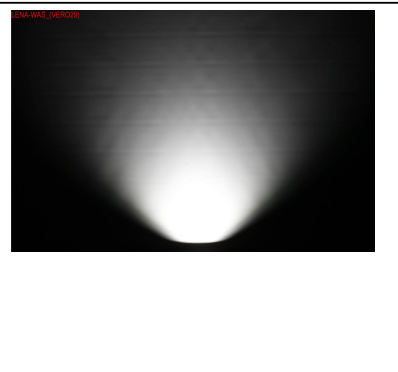
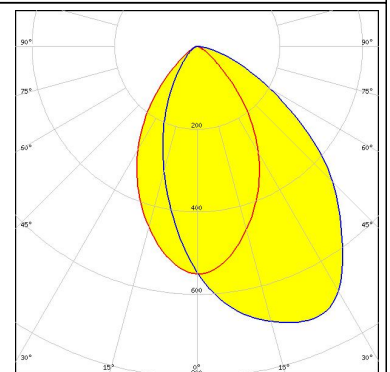
<p>bridgelux.</p> <p>LED VERO18 FWHM Asymmetric Efficiency 87 % Peak intensity 0.5 cd/lm LEDs/each optic 1 Light colour White Required components: C13868_LENA-STD-BASE-VERO13-18 C11996_LENA-LENS</p>		
<p>bridgelux.</p> <p>LED VERO18 FWHM Asymmetric Efficiency 86 % Peak intensity 0.9 cd/lm LEDs/each optic 1 Light colour White Required components: C13868_LENA-STD-BASE-VERO13-18 C11996_LENA-LENS</p>		
<p>bridgelux.</p> <p>LED VERO29 FWHM Asymmetric Efficiency 87 % Peak intensity 0.8 cd/lm LEDs/each optic 1 Light colour White Required components: C13867_LENA-STD-BASE-VERO29</p>		
<p>bridgelux.</p> <p>LED VERO29 FWHM Asymmetric Efficiency 82 % Peak intensity 0.7 cd/lm LEDs/each optic 1 Light colour White Required components: C13867_LENA-STD-BASE-VERO29 C11996_LENA-LENS</p>		

PHOTOMETRIC DATA (MEASURED):

CITIZEN

LED CL-L340
 FWHM Asymmetric
 Efficiency 84 %
 Peak intensity 1.2 cd/lm
 LEDs/each optic 1
 Light colour White
 Required components:
 C11995_LENA-STD-BASE-CL340

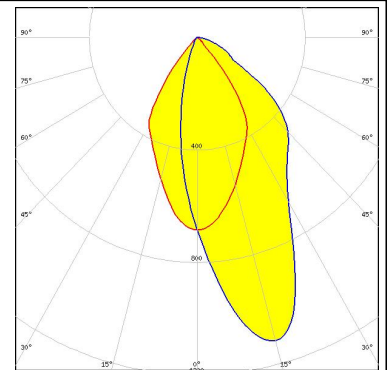
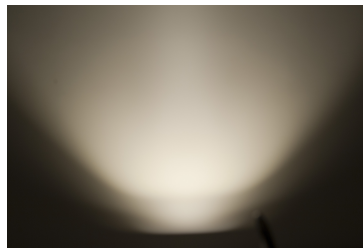

CITIZEN

LED CL-L340
 FWHM Asymmetric
 Efficiency 73 %
 Peak intensity 0.9 cd/lm
 LEDs/each optic 1
 Light colour White
 Required components:
 C11995_LENA-STD-BASE-CL340
 C11996_LENA-LENS

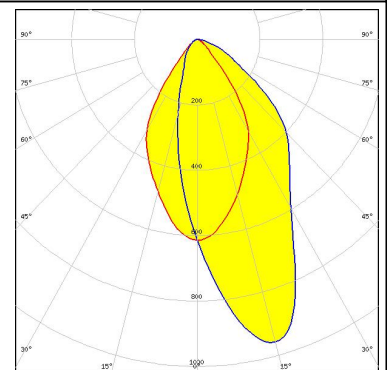
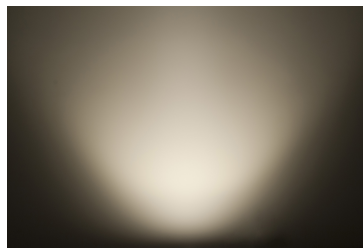

CITIZEN

LED CLL03x/CLU03x
 FWHM Asymmetric
 Efficiency 76 %
 Peak intensity 1 cd/lm
 LEDs/each optic 1
 Light colour White
 Required components:
 C12691_LENA-STD-BASE-CLL030
 C11996_LENA-LENS

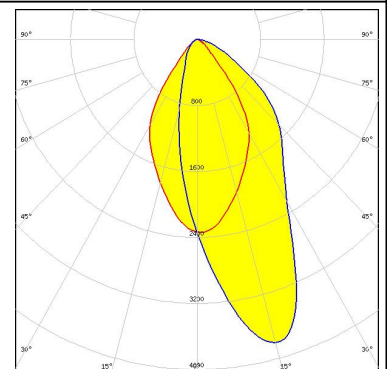
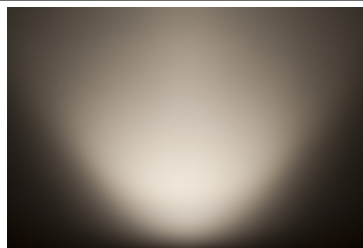

CITIZEN

LED CLL03x/CLU03x
 FWHM Asymmetric
 Efficiency 85 %
 Peak intensity 0.9 cd/lm
 LEDs/each optic 1
 Light colour White
 Required components:
 C13868_LENA-STD-BASE-VERO13-18
 C11996_LENA-LENS
 Bender Wirth: 433 Typ L1

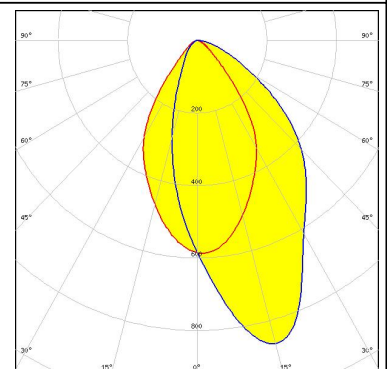
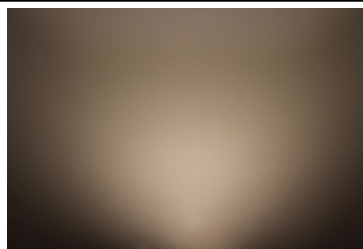

PHOTOMETRIC DATA (MEASURED):

CITIZEN

LED CLL03x/CLU03x
 FWHM Asymmetric
 Efficiency 90 %
 Peak intensity 1.1 cd/lm
 LEDs/each optic 1
 Light colour White
 Required components:
 C13868_LENA-STD-BASE-VERO13-18
 Bender Wirth: 433 Typ L1

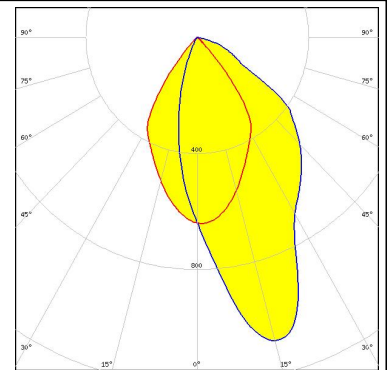
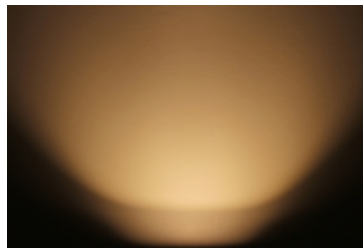

CITIZEN

LED CLL03x/CLU03x
 FWHM Asymmetric
 Efficiency 87 %
 Peak intensity 0.5 cd/lm
 LEDs/each optic 1
 Light colour White
 Required components:
 C13868_LENA-STD-BASE-VERO13-18
 C11996_LENA-LENS
 Bender Wirth: 433 Typ L1

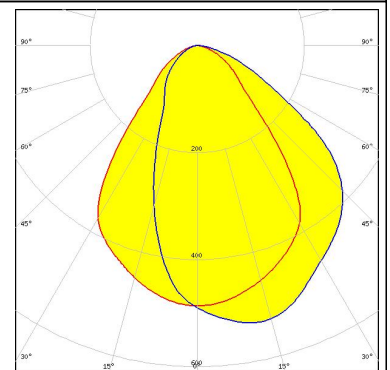
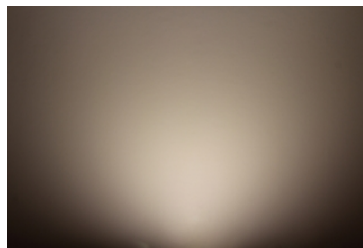

CITIZEN

LED CLL03x/CLU03x
 FWHM Asymmetric
 Efficiency 87 %
 Peak intensity 1.1 cd/lm
 LEDs/each optic 1
 Light colour White
 Required components:
 A.A.G. STUCCHI: 8101/G2 + S-8000/11

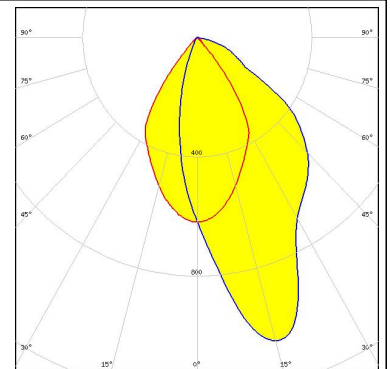

CITIZEN

LED CLL03x/CLU03x
 FWHM Asymmetric
 Efficiency 81 %
 Peak intensity 1.2 cd/lm
 LEDs/each optic 1
 Light colour White
 Required components:
 C12691_LENA-STD-BASE-CLL030

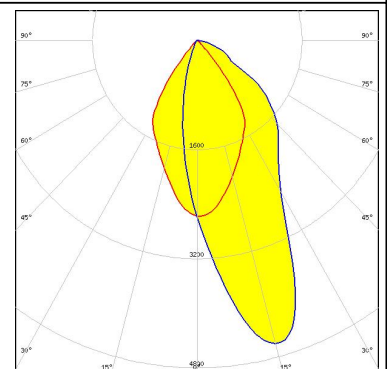

PHOTOMETRIC DATA (MEASURED):

CITIZEN

LED CLL03x/CLU03x
 FWHM Asymmetric
 Efficiency 90 %
 Peak intensity 1.1 cd/lm
 LEDs/each optic 1
 Light colour White
 Required components:
 C13867_LENA-STD-BASE-VERO29
 Bender Wirth: 433 Typ L1

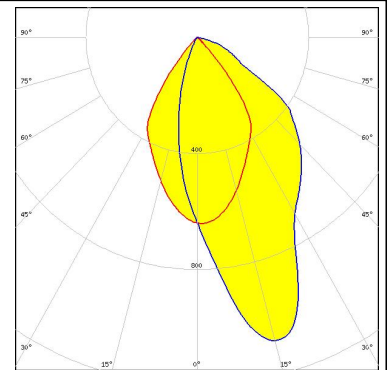
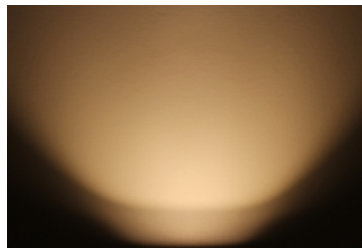

CITIZEN

LED CLL04x/CLU04x
 FWHM Asymmetric
 Efficiency 89 %
 Peak intensity 0.9 cd/lm
 LEDs/each optic 1
 Light colour White
 Required components:
 C13867_LENA-STD-BASE-VERO29
 Bender Wirth: 431 Typ L3

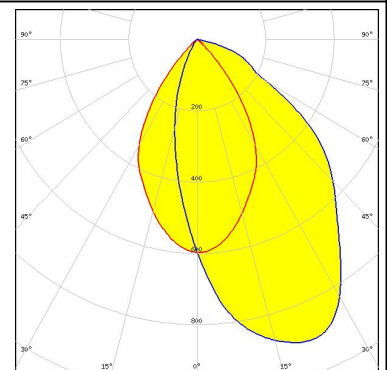
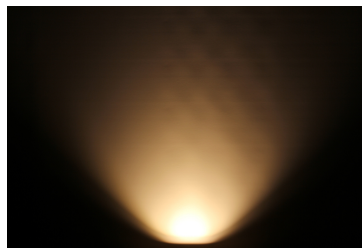

CITIZEN

LED CLL04x/CLU04x
 FWHM Asymmetric
 Efficiency 82 %
 Peak intensity 1 cd/lm
 LEDs/each optic 1
 Light colour White
 Required components:
 C12692_LENA-STD-BASE-CLL040

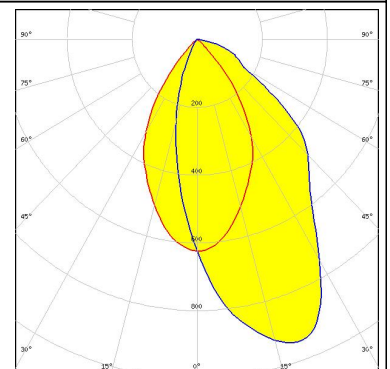
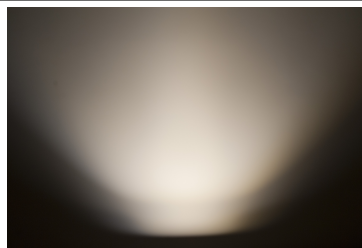

CITIZEN

LED CLL04x/CLU04x
 FWHM Asymmetric
 Efficiency 84 %
 Peak intensity 0.8 cd/lm
 LEDs/each optic 1
 Light colour White
 Required components:
 C13867_LENA-STD-BASE-VERO29
 C11996_LENA-LENS
 Bender Wirth: 431 Typ L3

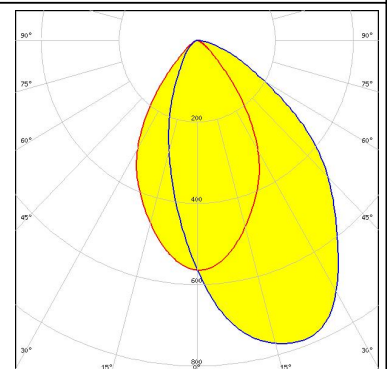

PHOTOMETRIC DATA (MEASURED):

CITIZEN

LED CLL04x/CLU04x
 FWHM Asymmetric
 Efficiency 78 %
 Peak intensity 0.8 cd/lm
 LEDs/each optic 1
 Light colour White
 Required components:
 C12692_LENA-STD-BASE-CLL040
 C11996_LENA-LENS

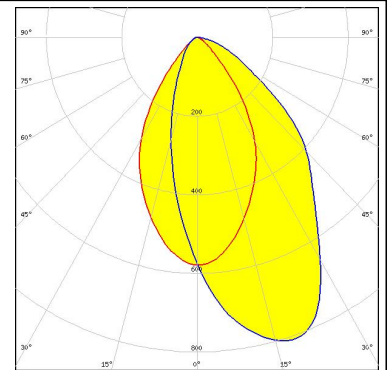

CITIZEN

LED CLL04x/CLU04x
 FWHM Asymmetric
 Efficiency 80 %
 Peak intensity 0.8 cd/lm
 LEDs/each optic 1
 Light colour White
 Required components:
 A.A.G. STUCCHI: 8102/G2 + S-8000/12

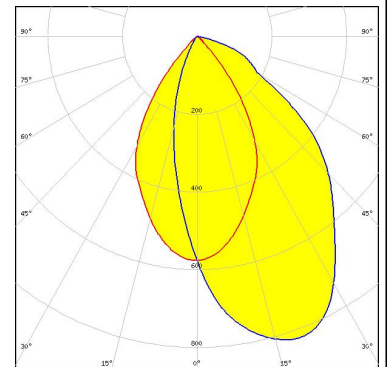

CITIZEN

LED CLL04x/CLU04x
 FWHM Asymmetric
 Efficiency 74 %
 Peak intensity 0.6 cd/lm
 LEDs/each optic 1
 Light colour White
 Required components:
 C11996_LENA-LENS
 A.A.G. STUCCHI: 8102/G2 + S-8000/12

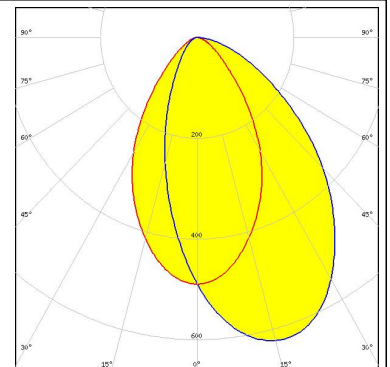

CITIZEN

LED CLL04x/CLU04x
 FWHM Asymmetric
 Efficiency 82 %
 Peak intensity 0.7 cd/lm
 LEDs/each optic 1
 Light colour White
 Required components:
 C11996_LENA-LENS
 IDEAL: 50-2204CT + 50-2100LN

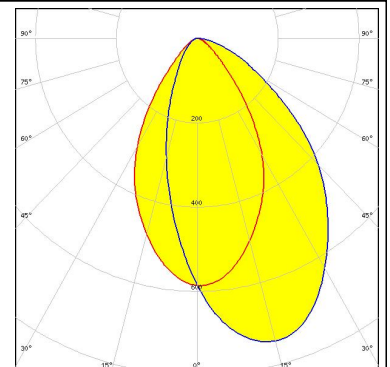
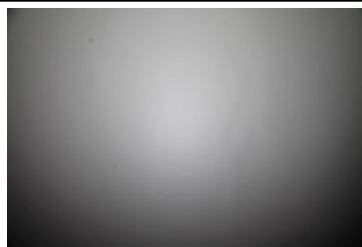

PHOTOMETRIC DATA (MEASURED):

CITIZEN

LED CLU700/701/702
 FWHM Asymmetric
 Efficiency 84 %
 Peak intensity 1 cd/lm
 LEDs/each optic 1
 Light colour White
 Required components:
 C13868_LENA-STD-BASE-VERO13-18
 C11996_LENA-LENS
 Bender Wirth: 434 Typ L1

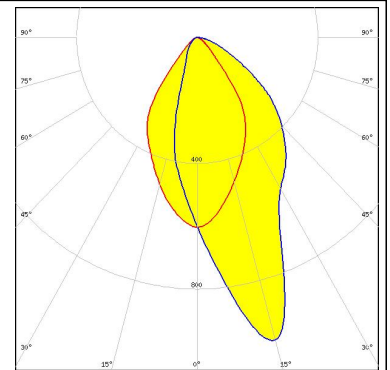
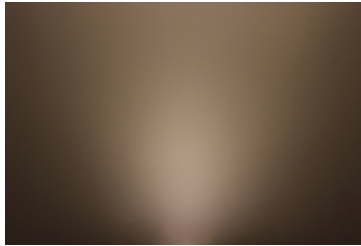

CITIZEN

LED CLU700/701/702
 FWHM Asymmetric
 Efficiency 89 %
 Peak intensity 1.3 cd/lm
 LEDs/each optic 1
 Light colour White
 Required components:
 C13868_LENA-STD-BASE-VERO13-18
 Bender Wirth: 434 Typ L1

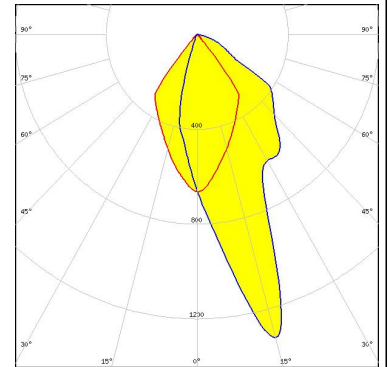
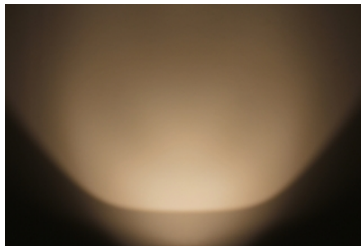

CITIZEN

LED CLU710/711
 FWHM Asymmetric
 Efficiency 89 %
 Peak intensity 1.2 cd/lm
 LEDs/each optic 1
 Light colour White
 Required components:
 C12691_LENA-STD-BASE-CLL030

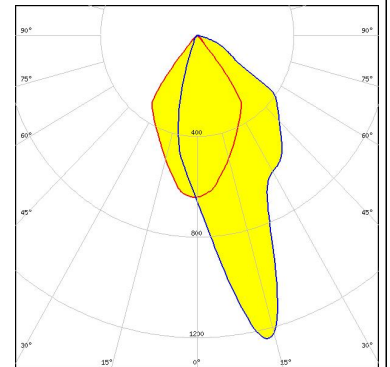

CITIZEN

LED CLU710/711
 FWHM Asymmetric
 Efficiency 84 %
 Peak intensity 1 cd/lm
 LEDs/each optic 1
 Light colour White
 Required components:
 C12691_LENA-STD-BASE-CLL030
 C11996_LENA-LENS

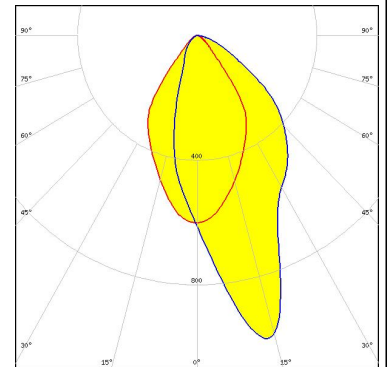

PHOTOMETRIC DATA (MEASURED):

CITIZEN

LED CLU720/721
 FWHM Asymmetric
 Efficiency 85 %
 Peak intensity 0.9 cd/lm
 LEDs/each optic 1
 Light colour White
 Required components:
 C13868_LENA-STD-BASE-VERO13-18
 C11996_LENA-LENS
 Bender Wirth: 433 Typ L1

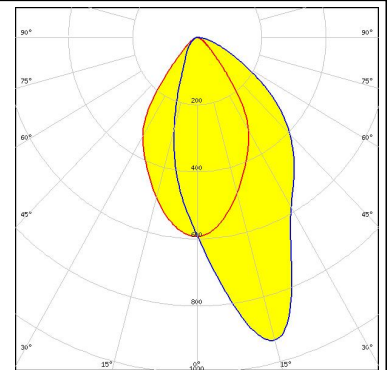

CITIZEN

LED CLU720/721
 FWHM Asymmetric
 Efficiency 90 %
 Peak intensity 1.2 cd/lm
 LEDs/each optic 1
 Light colour White
 Required components:
 C13868_LENA-STD-BASE-VERO13-18
 Bender Wirth: 433 Typ L1

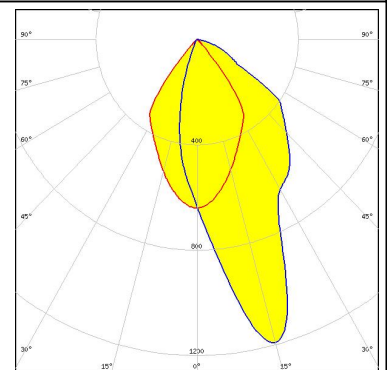
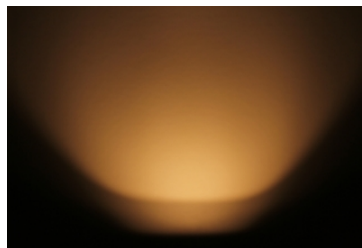

CITIZEN

LED CLU720/721
 FWHM Asymmetric
 Efficiency 86 %
 Peak intensity 0.5 cd/lm
 LEDs/each optic 1
 Light colour White
 Required components:
 C13868_LENA-STD-BASE-VERO13-18
 C11996_LENA-LENS
 Bender Wirth: 433 Typ L1

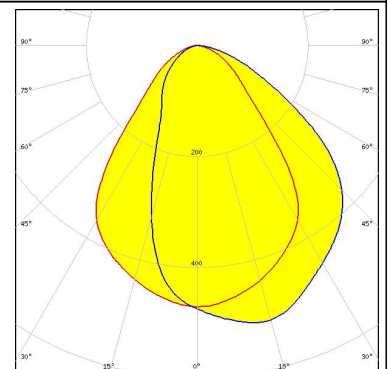
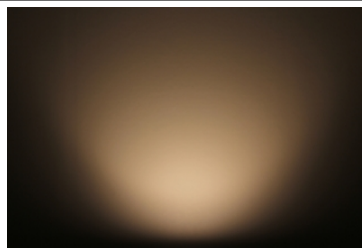

CITIZEN

LED CLU720/721
 FWHM Asymmetric
 Efficiency 90 %
 Peak intensity 1.2 cd/lm
 LEDs/each optic 1
 Light colour White
 Required components:
 C13867_LENA-STD-BASE-VERO29
 Bender Wirth: 433 Typ L1

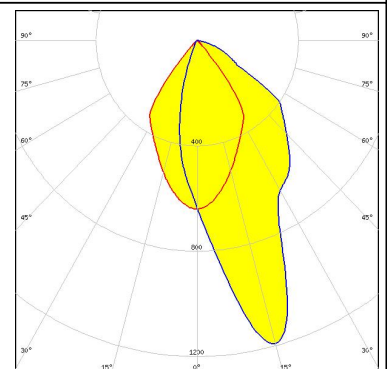
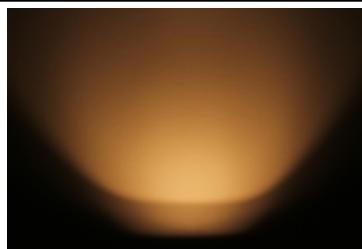

PHOTOMETRIC DATA (MEASURED):

CREE 

LED CMA1840
 FWHM Asymmetric
 Efficiency 86 %
 Peak intensity 1.2 cd/lm
 LEDs/each optic 1
 Light colour White
 Required components:
 C14146_LENA-STD-BASE-CXA18

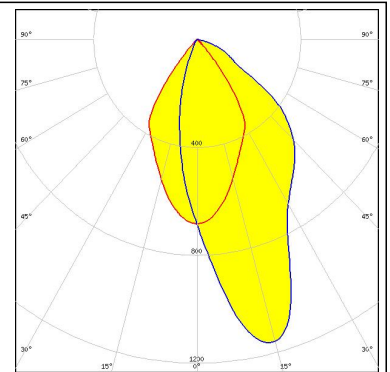

CREE 

LED CMA2550
 FWHM Asymmetric
 Efficiency 86 %
 Peak intensity 1 cd/lm
 LEDs/each optic 1
 Light colour White
 Required components:
 C13324_LENA-STD-BASE-CXA25

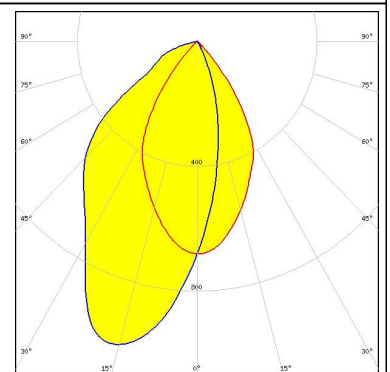
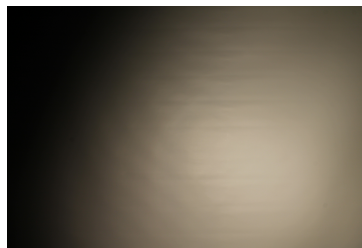

CREE 

LED CMT14xx
 FWHM Asymmetric
 Efficiency 85 %
 Peak intensity 1.3 cd/lm
 LEDs/each optic 1
 Light colour White
 Required components:
 C13868_LENA-STD-BASE-VERO13-18
 Bender Wirth: 434 Typ L1

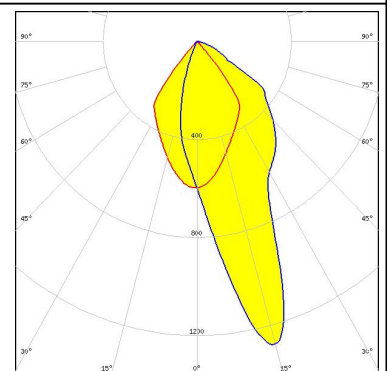
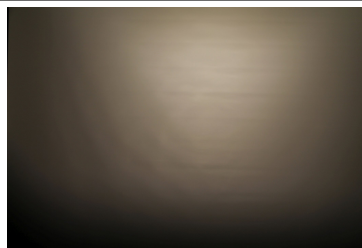

CREE 

LED CMT19xx
 FWHM Asymmetric
 Efficiency 86 %
 Peak intensity 1.1 cd/lm
 LEDs/each optic 1
 Light colour White
 Required components:
 C12691_LENA-STD-BASE-CLL030

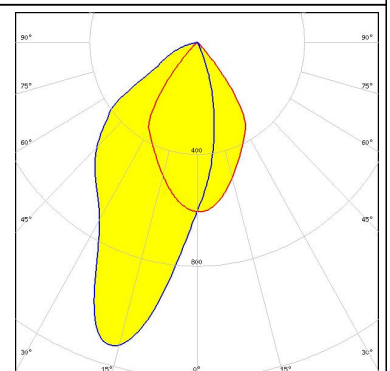
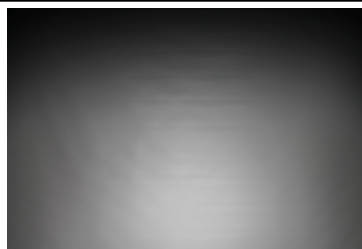

PHOTOMETRIC DATA (MEASURED):



LED CMT19xx
 FWHM Asymmetric
 Efficiency 86 %
 Peak intensity 1.2 cd/lm
 LEDs/each optic 1
 Light colour White
 Required components:
 C13868_LENA-STD-BASE-VERO13-18
 Bender Wirth: 477 Typ L1

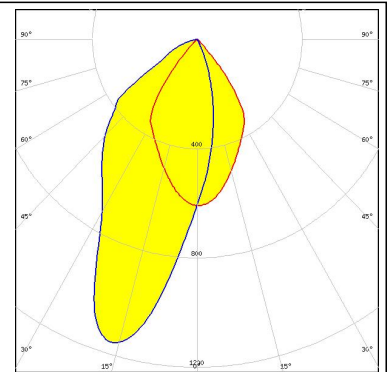
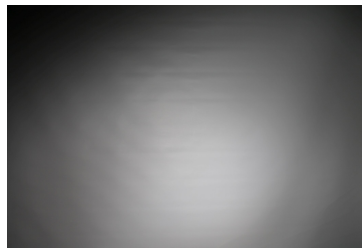

LED CMT28xx
 FWHM Asymmetric
 Efficiency 85 %
 Peak intensity 0.9 cd/lm
 LEDs/each optic 1
 Light colour White
 Required components:
 C13867_LENA-STD-BASE-VERO29
 Bender Wirth: 471 Typ L3

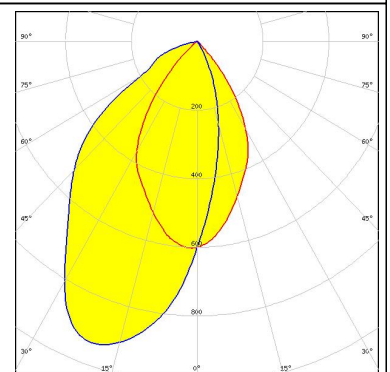
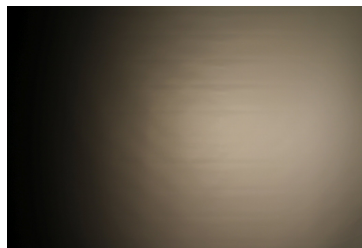

LED CMT28xx
 FWHM Asymmetric
 Efficiency 85 %
 Peak intensity 1 cd/lm
 LEDs/each optic 1
 Light colour White
 Required components:
 C12692_LENA-STD-BASE-CLL040

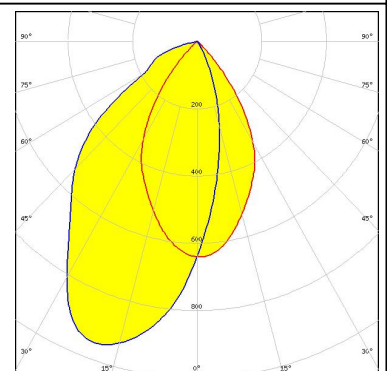
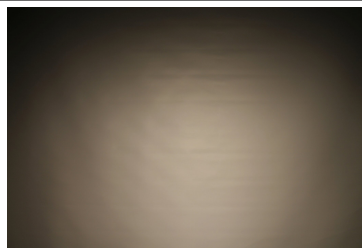

LED CXA/B 15xx
 FWHM Asymmetric
 Efficiency 89 %
 Peak intensity 1.3 cd/lm
 LEDs/each optic 1
 Light colour White
 Required components:
 C13868_LENA-STD-BASE-VERO13-18
 Bender Wirth: 441 Typ L1

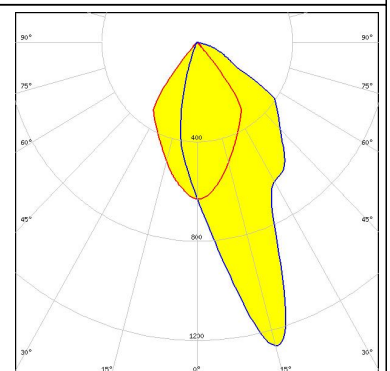
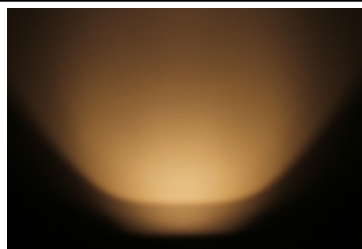

PHOTOMETRIC DATA (MEASURED):



LED CXA/B 15xx
 FWHM Asymmetric
 Efficiency 86 %
 Peak intensity 0.5 cd/lm
 LEDs/each optic 1
 Light colour White
 Required components:
 C13868_LENA-STD-BASE-VERO13-18
 C11996_LENA-LENS
 Bender Wirth: 441 Typ L1

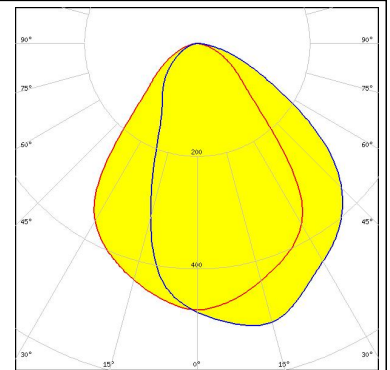

LED CXA/B 15xx
 FWHM Asymmetric
 Efficiency 84 %
 Peak intensity 1.1 cd/lm
 LEDs/each optic 1
 Light colour White
 Required components:
 C13186_LENA-STD-BASE-CXA15
 C11996_LENA-LENS

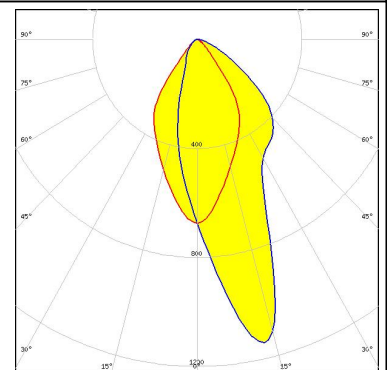

LED CXA/B 15xx
 FWHM Asymmetric
 Efficiency 85 %
 Peak intensity 1 cd/lm
 LEDs/each optic 1
 Light colour White
 Required components:
 C13868_LENA-STD-BASE-VERO13-18
 C11996_LENA-LENS
 Bender Wirth: 441 Typ L1

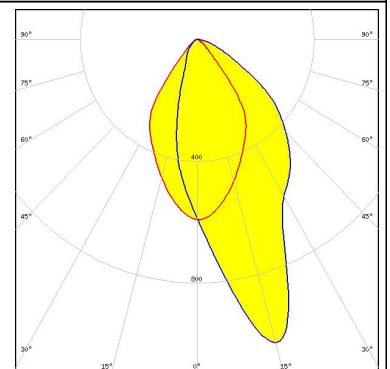
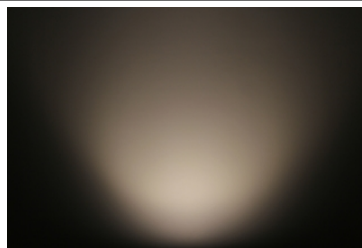

LED CXA/B 15xx
 FWHM Asymmetric
 Efficiency 88 %
 Peak intensity 1.4 cd/lm
 LEDs/each optic 1
 Light colour White
 Required components:
 C13186_LENA-STD-BASE-CXA15

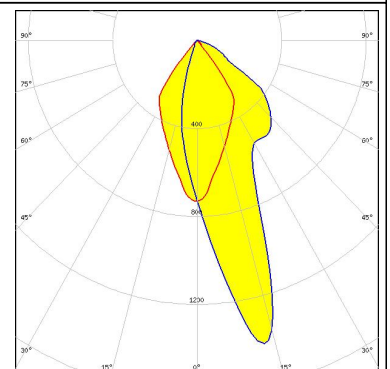

PHOTOMETRIC DATA (MEASURED):



LED CXA/B 1816 & CXA/B 1820 & CXA 1850
 FWHM Asymmetric
 Efficiency 88 %
 Peak intensity 1.1 cd/lm
 LEDs/each optic 1
 Light colour White
 Required components:
 C14146_LENA-STD-BASE-CXA18

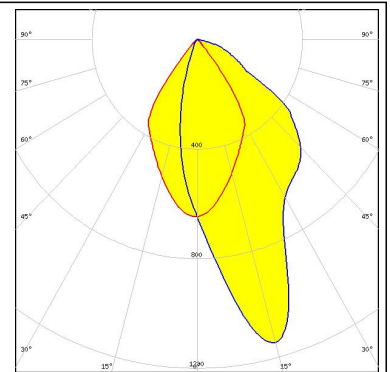
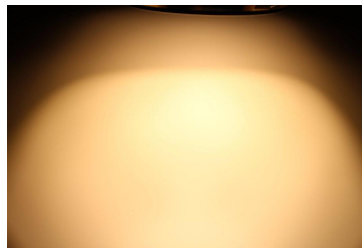

LED CXA/B 1816 & CXA/B 1820 & CXA 1850
 FWHM Asymmetric
 Efficiency 84 %
 Peak intensity 0.9 cd/lm
 LEDs/each optic 1
 Light colour White
 Required components:
 C13868_LENA-STD-BASE-VERO13-18
 C11996_LENA-LENS
 Bender Wirth: 437 Typ L1

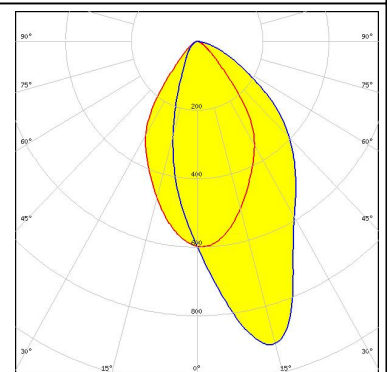
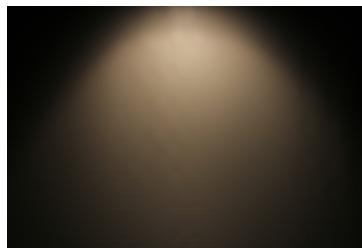

LED CXA/B 1816 & CXA/B 1820 & CXA 1850
 FWHM Asymmetric
 Efficiency 87 %
 Peak intensity 1.2 cd/lm
 LEDs/each optic 1
 Light colour White
 Required components:
 C13868_LENA-STD-BASE-VERO13-18
 Bender Wirth: 437 Typ L1

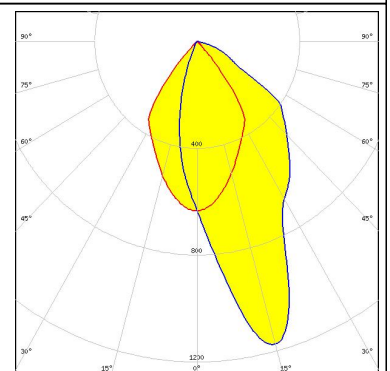
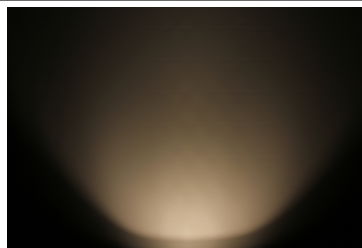

LED CXA/B 1816 & CXA/B 1820 & CXA 1850
 FWHM Asymmetric
 Efficiency 86 %
 Peak intensity 0.5 cd/lm
 LEDs/each optic 1
 Light colour White
 Required components:
 C13868_LENA-STD-BASE-VERO13-18
 C11996_LENA-LENS
 Bender Wirth: 437 Typ L1

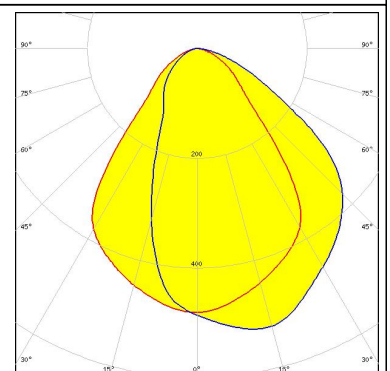
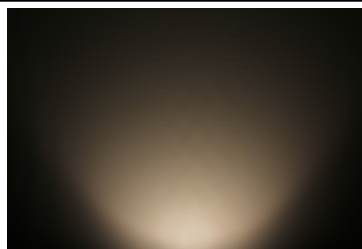

PHOTOMETRIC DATA (MEASURED):

CREE

LED CXA/B 25xx
 FWHM Asymmetric
 Efficiency 75 %
 Peak intensity 0.9 cd/lm
 LEDs/each optic 1
 Light colour White
 Required components:
 C13324_LENA-STD-BASE-CXA25

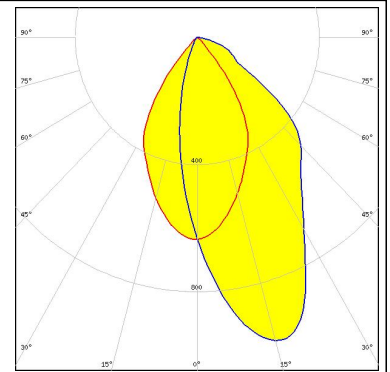

CREE

LED CXA2011
 FWHM Asymmetric
 Efficiency 79 %
 Peak intensity 1 cd/lm
 LEDs/each optic 1
 Light colour White
 Required components:
 C12105_LENA-STD-BASE-CXA20

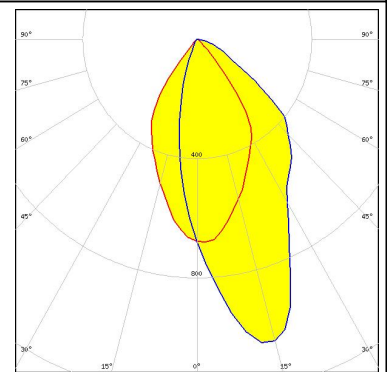

CREE

LED CXA2011
 FWHM Asymmetric
 Efficiency 75 %
 Peak intensity 0.9 cd/lm
 LEDs/each optic 1
 Light colour White
 Required components:
 C12105_LENA-STD-BASE-CXA20
 C11996_LENA-LENS

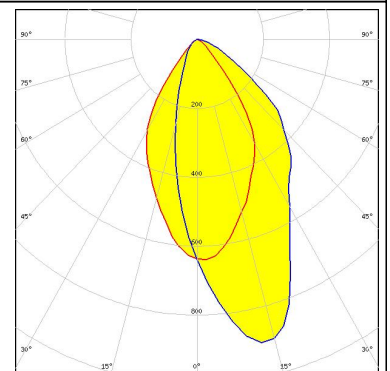

LUMILEDS

LED LUXEON CoB 1202/1203
 FWHM Asymmetric
 Efficiency 86 %
 Peak intensity 0.5 cd/lm
 LEDs/each optic 1
 Light colour White
 Required components:
 C13868_LENA-STD-BASE-VERO13-18
 C11996_LENA-LENS
 Bender Wirth: 438 Typ L1

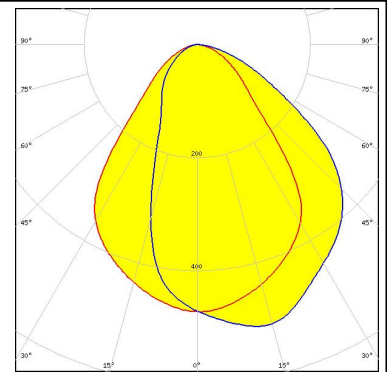
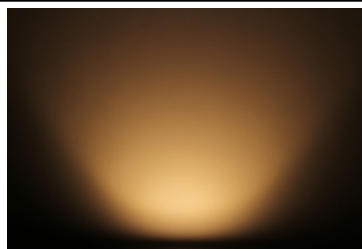

PHOTOMETRIC DATA (MEASURED):

LUMILEDS

LED LUXEON CoB 1202/1203
 FWHM Asymmetric
 Efficiency 89 %
 Peak intensity 1.3 cd/lm
 LEDs/each optic 1
 Light colour White
 Required components:
 C13868_LENA-STD-BASE-VERO13-18
 Bender Wirth: 438 Typ L1

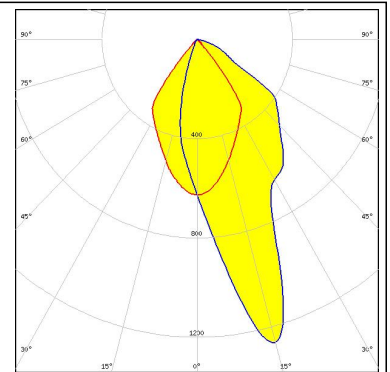
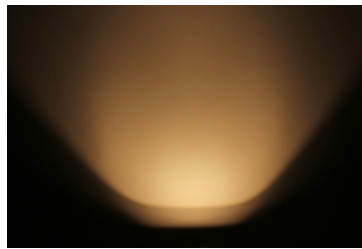

LUMILEDS

LED LUXEON CoB 1202/1203
 FWHM Asymmetric
 Efficiency 84 %
 Peak intensity 1 cd/lm
 LEDs/each optic 1
 Light colour White
 Required components:
 C13868_LENA-STD-BASE-VERO13-18
 C11996_LENA-LENS
 Bender Wirth: 438 Typ L1

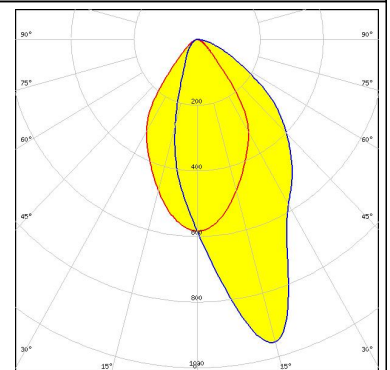
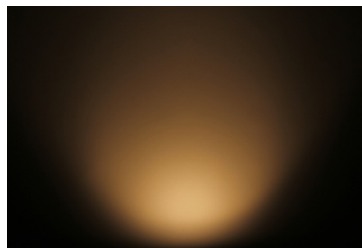

LUMILEDS

LED LUXEON CoB 1204HD
 FWHM Asymmetric
 Efficiency 86 %
 Peak intensity 1.3 cd/lm
 LEDs/each optic 1
 Light colour White
 Required components:
 C11981_LENA-STD-BASE-COB-L110

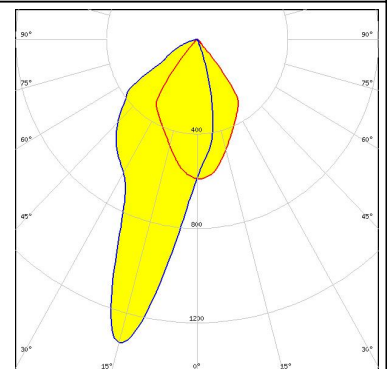
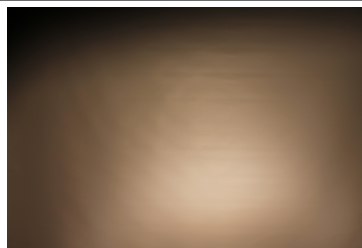

LUMILEDS

LED LUXEON CoB 1205HD
 FWHM Asymmetric
 Efficiency 86 %
 Peak intensity 1.3 cd/lm
 LEDs/each optic 1
 Light colour White
 Required components:
 C11981_LENA-STD-BASE-COB-L110

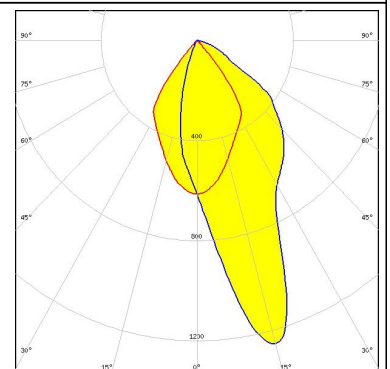
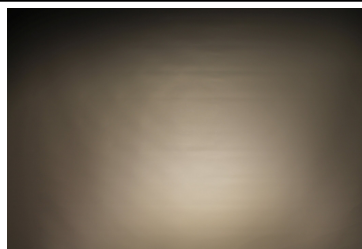

PHOTOMETRIC DATA (MEASURED):

LUMILEDS

LED LUXEON CoB 1211
 FWHM Asymmetric
 Efficiency 89 %
 Peak intensity 1 cd/lm
 LEDs/each optic 1
 Light colour White
 Required components:
 C13867_LENA-STD-BASE-VERO29
 Bender Wirth: 431 Typ L3

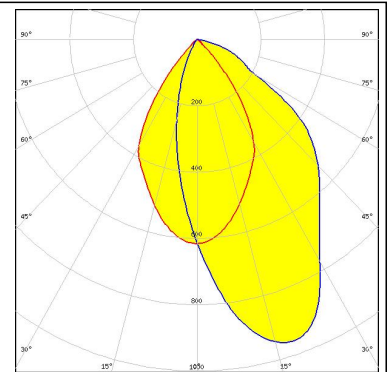
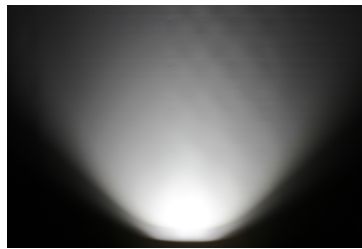

LUMILEDS

LED LUXEON CoB 1211
 FWHM Asymmetric
 Efficiency 84 %
 Peak intensity 0.8 cd/lm
 LEDs/each optic 1
 Light colour White
 Required components:
 C13867_LENA-STD-BASE-VERO29
 C11996_LENA-LENS
 Bender Wirth: 431 Typ L3

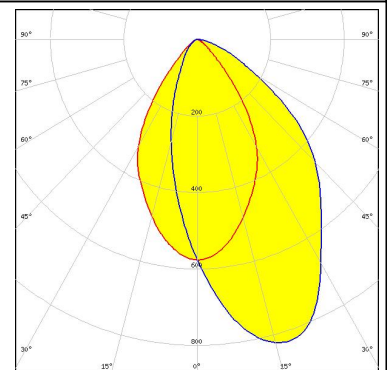
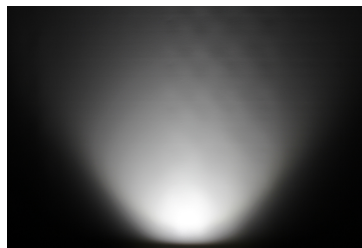

LUMILEDS

LED LUXEON CoB 1216/1812
 FWHM Asymmetric
 Efficiency 88 %
 Peak intensity 0.9 cd/lm
 LEDs/each optic 1
 Light colour White
 Required components:
 C12692_LENA-STD-BASE-CLL040

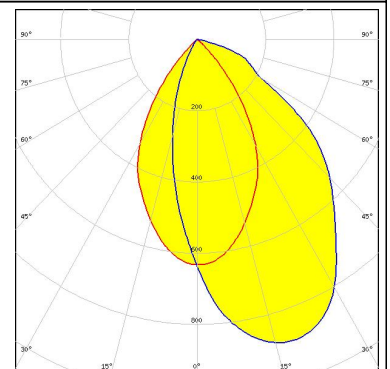
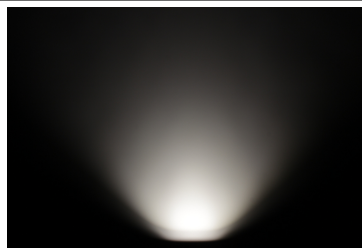

LUMILEDS

LED LUXEON CoB 1216/1812
 FWHM Asymmetric
 Efficiency 84 %
 Peak intensity 0.8 cd/lm
 LEDs/each optic 1
 Light colour White
 Required components:
 C12692_LENA-STD-BASE-CLL040
 C11996_LENA-LENS

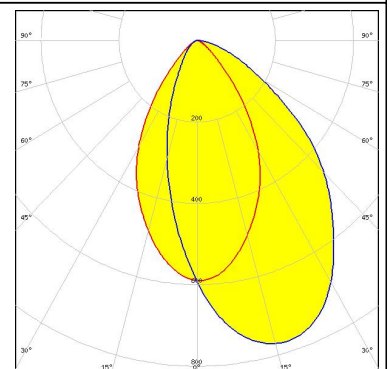
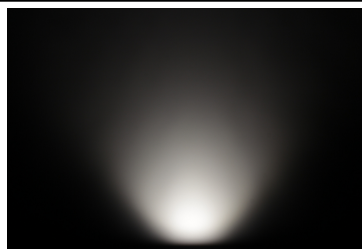

PHOTOMETRIC DATA (MEASURED):

LUMILEDS

LED LUXEON CoB 1216/1812
 FWHM 60.0°
 Efficiency 81 %
 Peak intensity 0.8 cd/lm
 LEDs/each optic 1
 Light colour White
 Required components:
 A.A.G. STUCCHI: 8102/G2 + S-8000/12

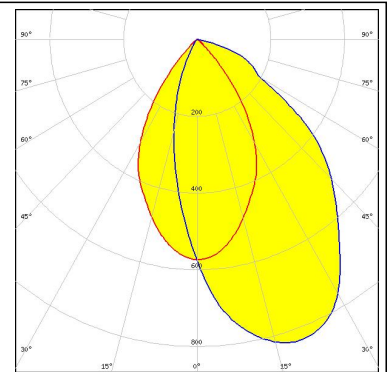
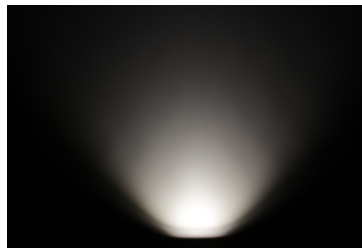

LUMILEDS

LED LUXEON CoB 1216/1812
 FWHM Asymmetric
 Efficiency 77 %
 Peak intensity 0.7 cd/lm
 LEDs/each optic 1
 Light colour White
 Required components:
 C11996_LENA-LENS
 A.A.G. STUCCHI: 8102/G2 + S-8000/12

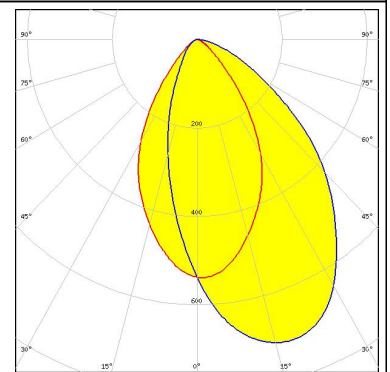
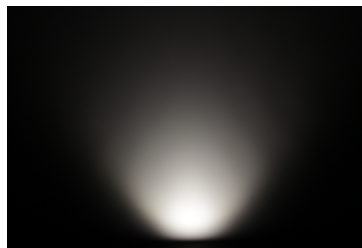

LUMILEDS

LED LUXEON K12
 FWHM Asymmetric
 Efficiency 77 %
 Peak intensity 1.1 cd/lm
 LEDs/each optic 1
 Light colour White
 Required components:
 C12924_LENA-STD-BASE-LUXEON-K
 C11996_LENA-LENS

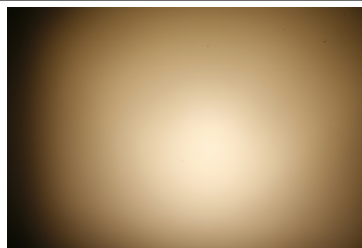

LUMILEDS

LED LUXEON K12
 FWHM Asymmetric
 Efficiency 82 %
 Peak intensity 1.3 cd/lm
 LEDs/each optic 1
 Light colour White
 Required components:
 C12924_LENA-STD-BASE-LUXEON-K

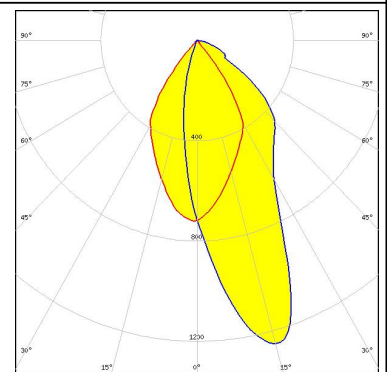
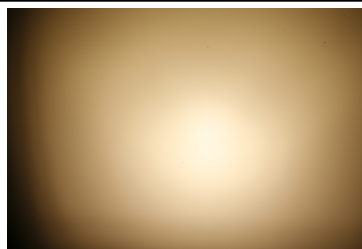

PHOTOMETRIC DATA (MEASURED):

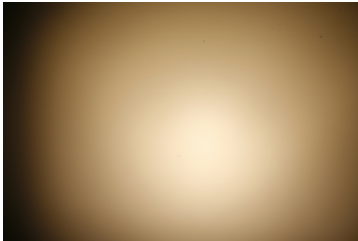
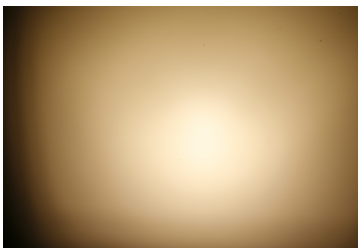
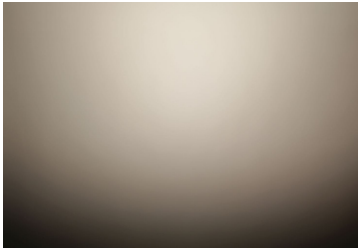
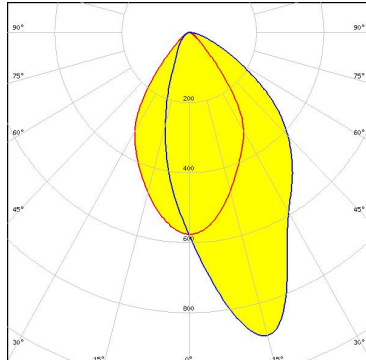
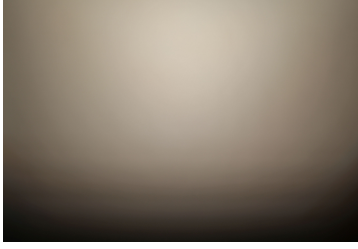
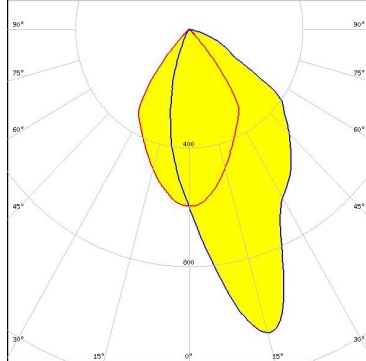
<p>LUMILEDS</p> <p>LED LUXEON K16 FWHM Asymmetric Efficiency 76 % Peak intensity 1 cd/lm LEDs/each optic 1 Light colour White</p> <p>Required components: C12924_LENA-STD-BASE-LUXEON-K C11996_LENA-LENS</p>		
<p>LUMILEDS</p> <p>LED LUXEON K16 FWHM Asymmetric Efficiency 81 % Peak intensity 1.1 cd/lm LEDs/each optic 1 Light colour White</p> <p>Required components: C12924_LENA-STD-BASE-LUXEON-K</p>		
<p>LUMINUS</p> <p>LED CDM-14 (Dim-To-Warm) FWHM Asymmetric Efficiency 83 % Peak intensity 0.9 cd/lm LEDs/each optic 1 Light colour White</p> <p>Required components: C13868_LENA-STD-BASE-VERO13-18 C11996_LENA-LENS Bender Wirth: 491 Typ L2</p>		
<p>LUMINUS</p> <p>LED CDM-14 (Dim-To-Warm) FWHM 59.0° Efficiency 88 % Peak intensity 1.1 cd/lm LEDs/each optic 1 Light colour White</p> <p>Required components: C13868_LENA-STD-BASE-VERO13-18 Bender Wirth: 491 Typ L2</p>		

PHOTOMETRIC DATA (MEASURED):



LED CDM-18 (Dim-To-Warm)
 FWHM Asymmetric
 Efficiency 83 %
 Peak intensity 0.8 cd/lm
 LEDs/each optic 1
 Light colour White
 Required components:
 C13868_LENA-STD-BASE-VERO13-18
 C11996_LENA-LENS
 Bender Wirth: 491 Typ L2

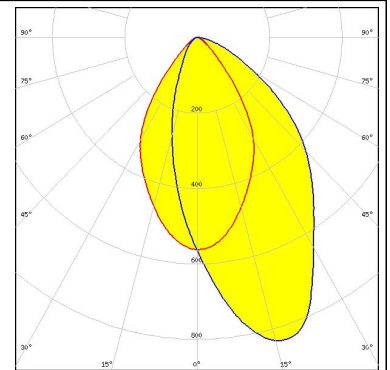

LED CDM-18 (Dim-To-Warm)
 FWHM Asymmetric
 Efficiency 88 %
 Peak intensity 1 cd/lm
 LEDs/each optic 1
 Light colour White
 Required components:
 C13868_LENA-STD-BASE-VERO13-18
 Bender Wirth: 491 Typ L2

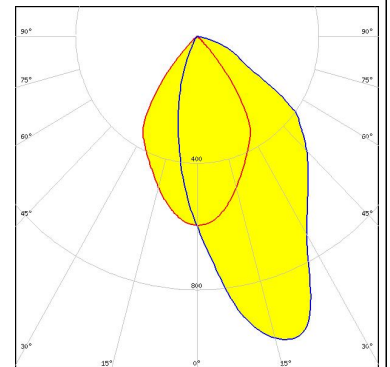

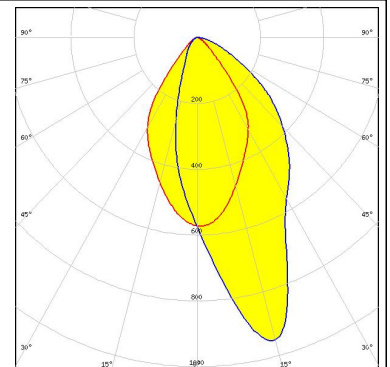

LED CDM-9 (Dim-To-Warm)
 FWHM Asymmetric
 Efficiency 83 %
 Peak intensity 1 cd/lm
 LEDs/each optic 1
 Light colour White
 Required components:
 C13868_LENA-STD-BASE-VERO13-18
 C11996_LENA-LENS
 Bender Wirth: 490 Typ L1

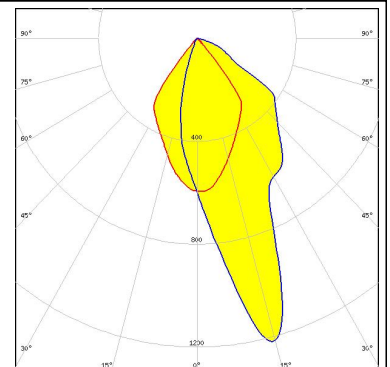
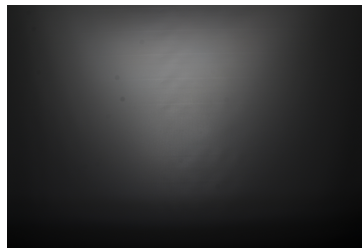

LED CDM-9 (Dim-To-Warm)
 FWHM Asymmetric
 Efficiency 88 %
 Peak intensity 1.2 cd/lm
 LEDs/each optic 1
 Light colour White
 Required components:
 C13868_LENA-STD-BASE-VERO13-18
 Bender Wirth: 490 Typ L1

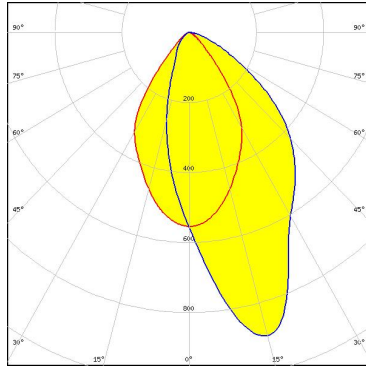
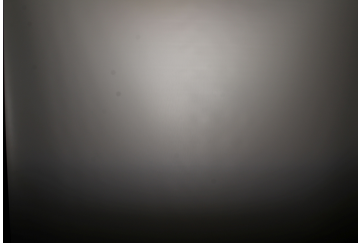
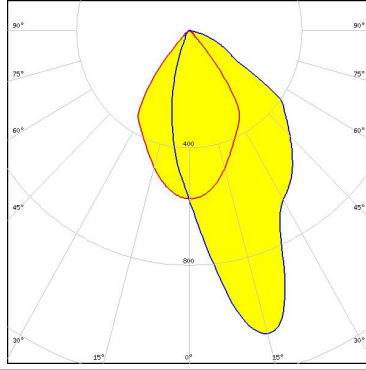

PHOTOMETRIC DATA (MEASURED):

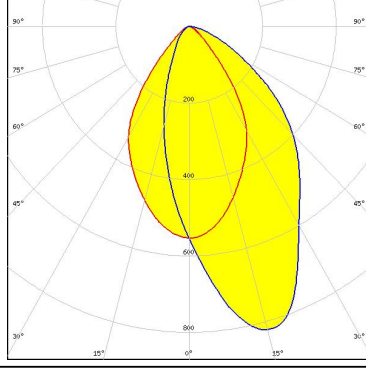
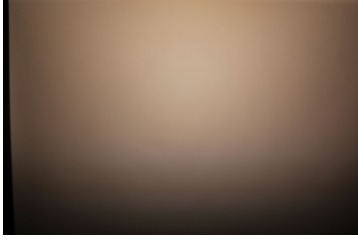
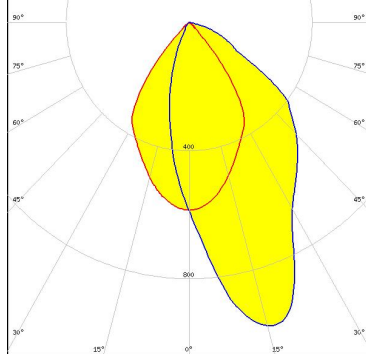
<p>LUMINUS</p> <p>LED CTM-14 (Tunable White) FWHM Asymmetric Efficiency 87 % Peak intensity 1.1 cd/lm LEDs/each optic 1 Light colour White</p> <p>Required components: C13867_LENA-STD-BASE-VERO29 C12606_LENINA-DL Bender Wirth: 442 Typ L3</p>		
<p>LUMINUS</p> <p>LED CTM-14 (Tunable White) FWHM Asymmetric Efficiency 87 % Peak intensity 1.1 cd/lm LEDs/each optic 1 Light colour White</p> <p>Required components: C13867_LENA-STD-BASE-VERO29 Bender Wirth: 442 Typ L3</p>		
<p>LUMINUS</p> <p>LED CTM-18 (Tunable White) FWHM Asymmetric Efficiency 82 % Peak intensity 0.8 cd/lm LEDs/each optic 1 Light colour White</p> <p>Required components: C13867_LENA-STD-BASE-VERO29 C11996_LENA-LENS Bender Wirth: 442 Typ L3</p>		
<p>LUMINUS</p> <p>LED CTM-18 (Tunable White) FWHM Asymmetric Efficiency 88 % Peak intensity 1 cd/lm LEDs/each optic 1 Light colour White</p> <p>Required components: C13867_LENA-STD-BASE-VERO29 Bender Wirth: 442 Typ L3</p>		

PHOTOMETRIC DATA (MEASURED):



LED CTM-22 (Tunable White)
 FWHM Asymmetric
 Efficiency 83 %
 Peak intensity 0.8 cd/lm
 LEDs/each optic 1
 Light colour White
 Required components:
 C13867_LENA-STD-BASE-VERO29
 C11996_LENA-LENS
 Bender Wirth: 494 Typ L3

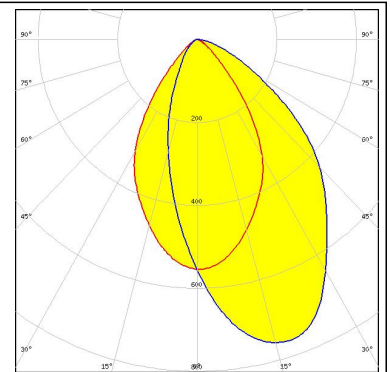
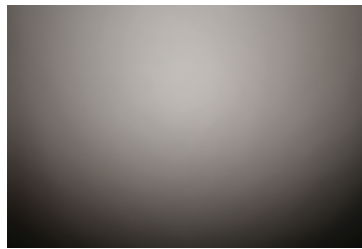

LED CTM-22 (Tunable White)
 FWHM Asymmetric
 Efficiency 87 %
 Peak intensity 0.9 cd/lm
 LEDs/each optic 1
 Light colour White
 Required components:
 C13867_LENA-STD-BASE-VERO29
 Bender Wirth: 494 Typ L3

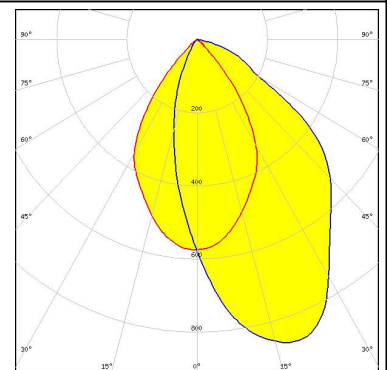
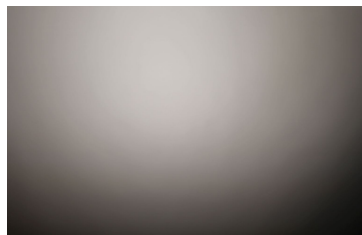

LED CxM-14 (19x19)
 FWHM Asymmetric
 Efficiency 87 %
 Peak intensity 1.1 cd/lm
 LEDs/each optic 1
 Light colour White
 Required components:
 C12691_LENA-STD-BASE-CLL030

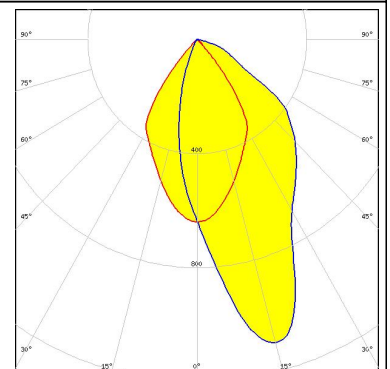
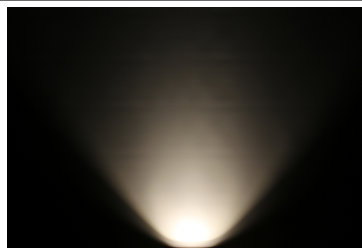

LED CxM-14 (19x19)
 FWHM Asymmetric
 Efficiency 82 %
 Peak intensity 0.9 cd/lm
 LEDs/each optic 1
 Light colour White
 Required components:
 C12691_LENA-STD-BASE-CLL030
 C11996_LENA-LENS

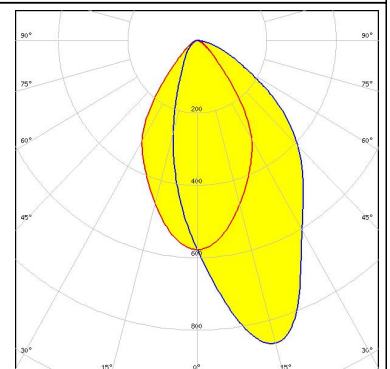
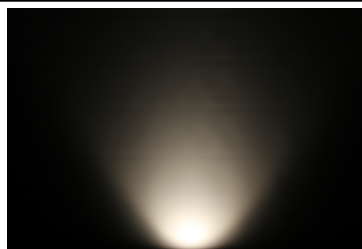

PHOTOMETRIC DATA (MEASURED):



LED CxM-22 (28x28)
 FWHM Asymmetric
 Efficiency 84 %
 Peak intensity 0.9 cd/lm
 LEDs/each optic 1
 Light colour White
 Required components:
 C12692_LENA-STD-BASE-CLL040

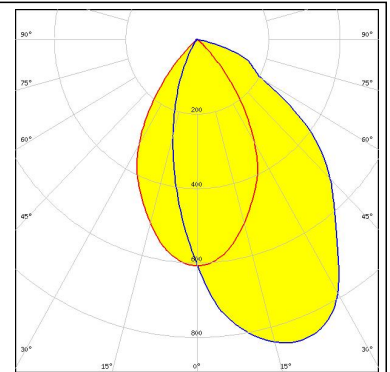
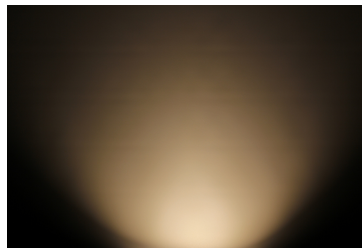

LED CxM-22 (28x28)
 FWHM Asymmetric
 Efficiency 79 %
 Peak intensity 0.7 cd/lm
 LEDs/each optic 1
 Light colour White
 Required components:
 C12692_LENA-STD-BASE-CLL040
 C11996_LENA-LENS

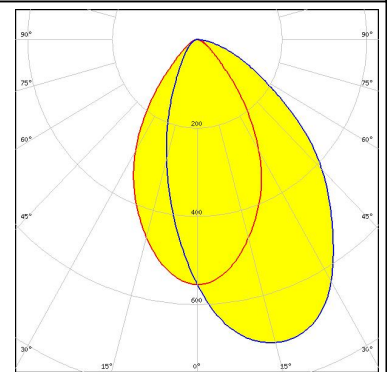
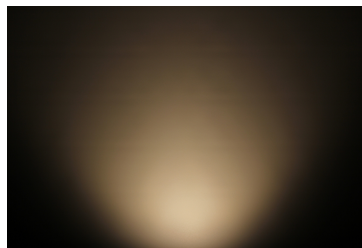

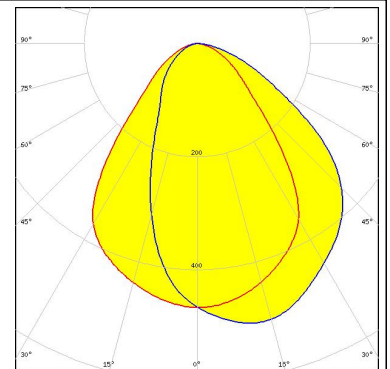
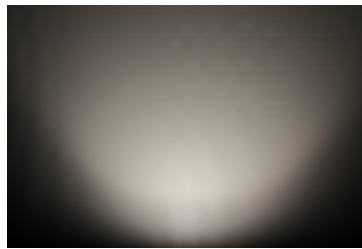

LED COB J-Type
 FWHM Asymmetric
 Efficiency 86 %
 Peak intensity 0.5 cd/lm
 LEDs/each optic 1
 Light colour White
 Required components:
 C13868_LENA-STD-BASE-VERO13-18
 C11996_LENA-LENS
 Bender Wirth: 463 Typ L2

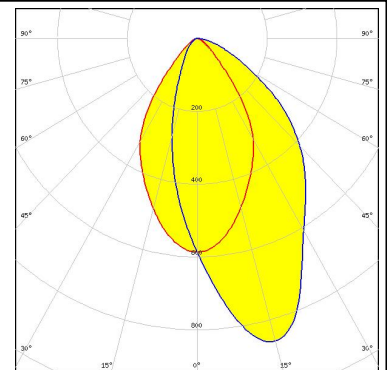
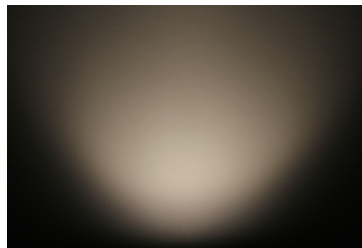

LED COB J-Type
 FWHM Asymmetric
 Efficiency 84 %
 Peak intensity 0.9 cd/lm
 LEDs/each optic 1
 Light colour White
 Required components:
 C13868_LENA-STD-BASE-VERO13-18
 C11996_LENA-LENS
 Bender Wirth: 463 Typ L2

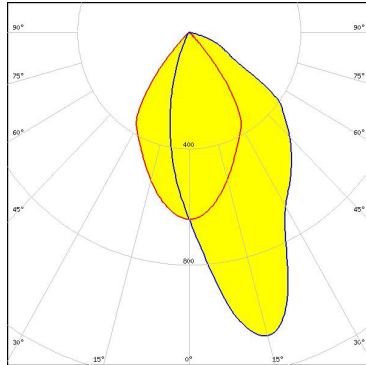
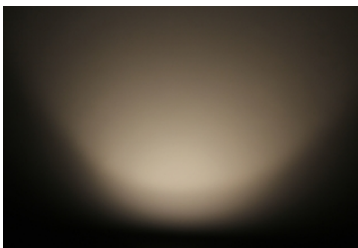
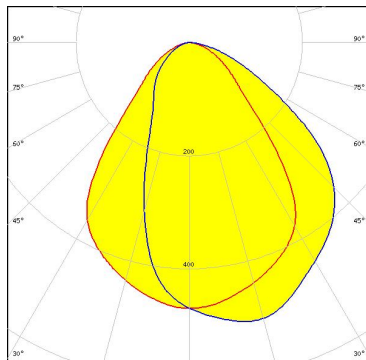

PHOTOMETRIC DATA (MEASURED):

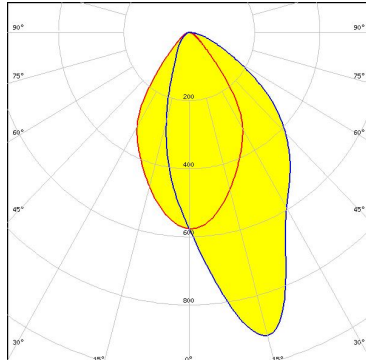
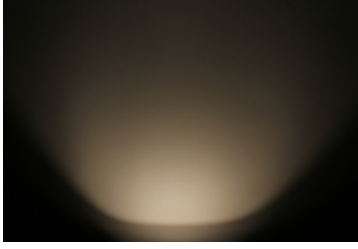
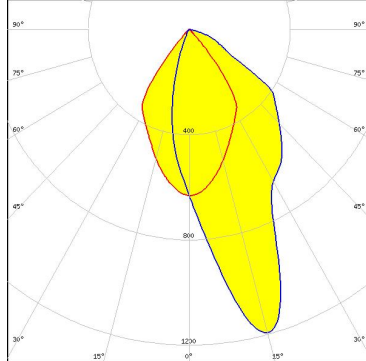
<p>NICHIA</p> <p>LED COB J-Type FWHM Asymmetric Efficiency 89 % Peak intensity 1.1 cd/lm LEDs/each optic 1 Light colour White</p> <p>Required components: C13868_LENA-STD-BASE-VERO13-18 Bender Wirth: 463 Typ L2</p>		
<p>NICHIA</p> <p>LED COB L-Type (LES 11) FWHM Asymmetric Efficiency 86 % Peak intensity 0.5 cd/lm LEDs/each optic 1 Light colour White</p> <p>Required components: C13868_LENA-STD-BASE-VERO13-18 C11996_LENA-LENS Bender Wirth: 438 Typ L1</p>		
<p>NICHIA</p> <p>LED COB L-Type (LES 11) FWHM Asymmetric Efficiency 84 % Peak intensity 0.9 cd/lm LEDs/each optic 1 Light colour White</p> <p>Required components: C13868_LENA-STD-BASE-VERO13-18 C11996_LENA-LENS Bender Wirth: 438 Typ L1</p>		
<p>NICHIA</p> <p>LED COB L-Type (LES 11) FWHM Asymmetric Efficiency 89 % Peak intensity 1.2 cd/lm LEDs/each optic 1 Light colour White</p> <p>Required components: C13868_LENA-STD-BASE-VERO13-18 Bender Wirth: 438 Typ L1</p>		

PHOTOMETRIC DATA (MEASURED):



LED COB L-Type (LES 9)
 FWHM Asymmetric
 Efficiency 85 %
 Peak intensity 0.5 cd/lm
 LEDs/each optic 1
 Light colour White
 Required components:
 C13868_LENA-STD-BASE-VERO13-18
 C11996_LENA-LENS
 Bender Wirth: 438 Typ L1

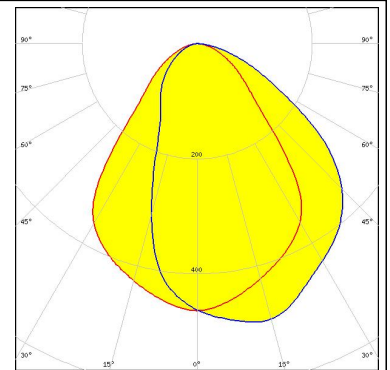
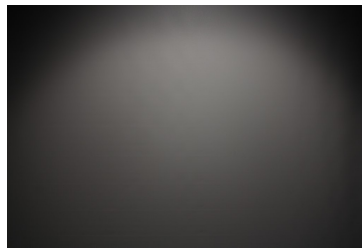

LED COB L-Type (LES 9)
 FWHM Asymmetric
 Efficiency 84 %
 Peak intensity 0.9 cd/lm
 LEDs/each optic 1
 Light colour White
 Required components:
 C13868_LENA-STD-BASE-VERO13-18
 C11996_LENA-LENS
 Bender Wirth: 438 Typ L1

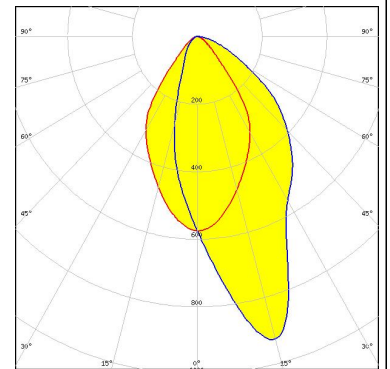
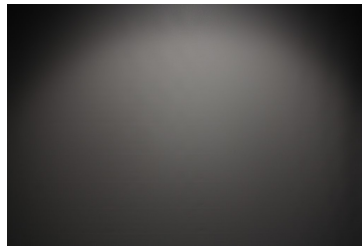

LED COB L-Type (LES 9)
 FWHM Asymmetric
 Efficiency 90 %
 Peak intensity 1.3 cd/lm
 LEDs/each optic 1
 Light colour White
 Required components:
 C13868_LENA-STD-BASE-VERO13-18
 Bender Wirth: 438 Typ L1

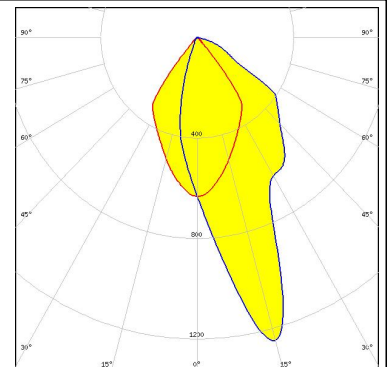
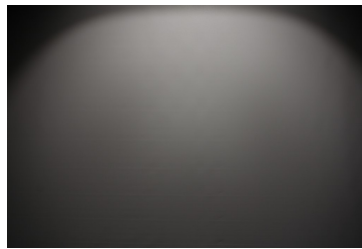

LED NVCWJ024Z-V1MT: COB J-Type Tunable White
 FWHM Asymmetric
 Efficiency 83 %
 Peak intensity 0.9 cd/lm
 LEDs/each optic 1
 Light colour White
 Required components:
 C13868_LENA-STD-BASE-VERO13-18
 C11996_LENA-LENS
 Bender Wirth: 498 Typ L2

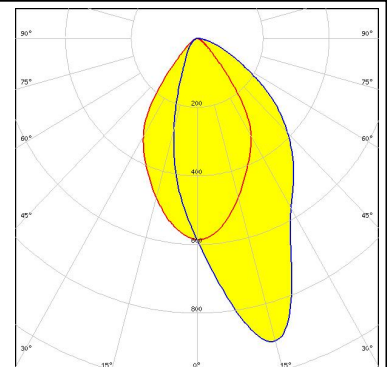
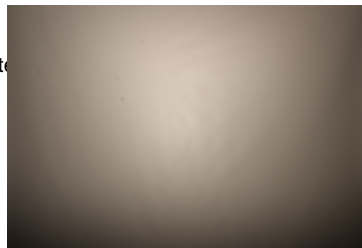

PHOTOMETRIC DATA (MEASURED):

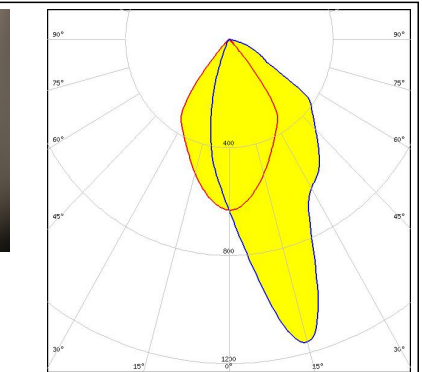
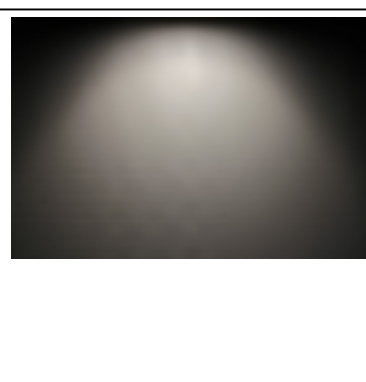
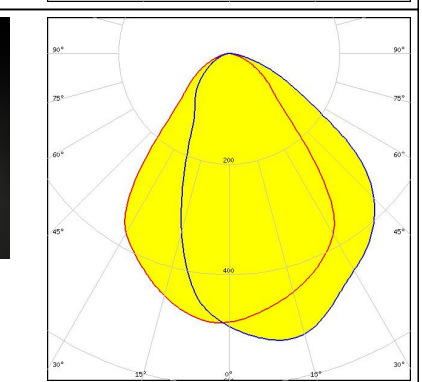
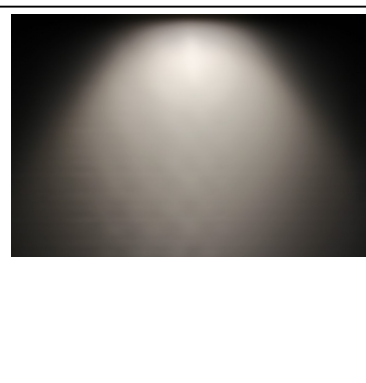
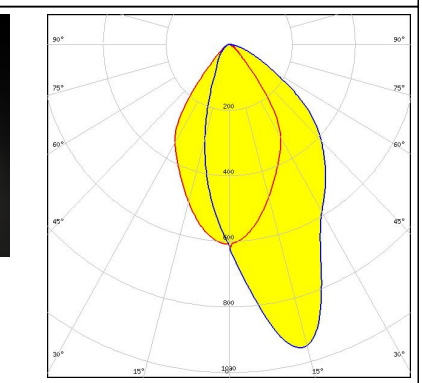
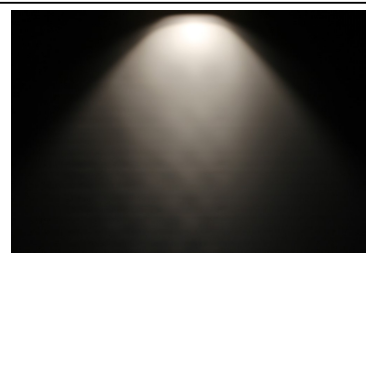
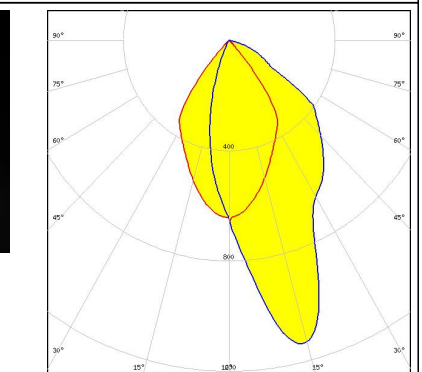
<p>NICHIA</p> <p>LED NVCWJ024Z-V1MT: COB J-Type Tunable White</p> <p>FWHM Asymmetric</p> <p>Efficiency 88 %</p> <p>Peak intensity 1.2 cd/lm</p> <p>LEDs/each optic 1</p> <p>Light colour White</p> <p>Required components: C13868_LENA-STD-BASE-VERO13-18 Bender Wirth: 498 Typ L2</p>		
<p>OSRAM Opto Semiconductors</p> <p>LED Soleriq S13</p> <p>FWHM Asymmetric</p> <p>Efficiency 86 %</p> <p>Peak intensity 0.5 cd/lm</p> <p>LEDs/each optic 1</p> <p>Light colour White</p> <p>Required components: C13868_LENA-STD-BASE-VERO13-18 C11996_LENA-LENS Bender Wirth: 437 Typ L1</p>		
<p>OSRAM Opto Semiconductors</p> <p>LED Soleriq S13</p> <p>FWHM Asymmetric</p> <p>Efficiency 84 %</p> <p>Peak intensity 1 cd/lm</p> <p>LEDs/each optic 1</p> <p>Light colour White</p> <p>Required components: C13868_LENA-STD-BASE-VERO13-18 C11996_LENA-LENS Bender Wirth: 437 Typ L1</p>		
<p>OSRAM Opto Semiconductors</p> <p>LED Soleriq S13</p> <p>FWHM Asymmetric</p> <p>Efficiency 88 %</p> <p>Peak intensity 1.1 cd/lm</p> <p>LEDs/each optic 1</p> <p>Light colour White</p> <p>Required components: C13868_LENA-STD-BASE-VERO13-18 Bender Wirth: 437 Typ L1</p>		

PHOTOMETRIC DATA (MEASURED):

OSRAM

Opto Semiconductors

LED Soleriq S19
 FWHM Asymmetric
 Efficiency 89 %
 Peak intensity 1 cd/lm
 LEDs/each optic 1
 Light colour White
 Required components:
 C13867_LENA-STD-BASE-VERO29
 Bender Wirth: 462 Typ L3

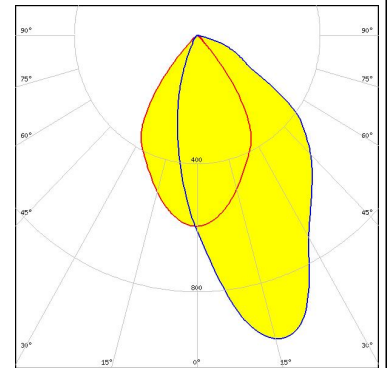
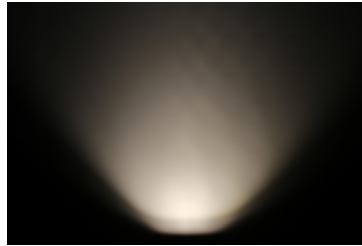

OSRAM

Opto Semiconductors

LED Soleriq S19
 FWHM Asymmetric
 Efficiency 84 %
 Peak intensity 0.9 cd/lm
 LEDs/each optic 1
 Light colour White
 Required components:
 C13867_LENA-STD-BASE-VERO29
 C11996_LENA-LENS
 Bender Wirth: 462 Typ L3

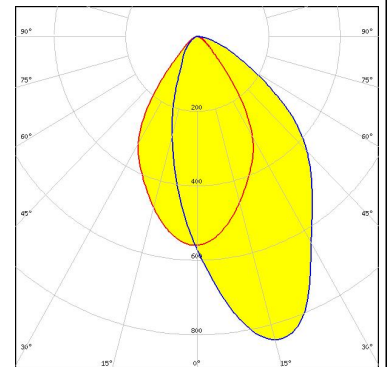
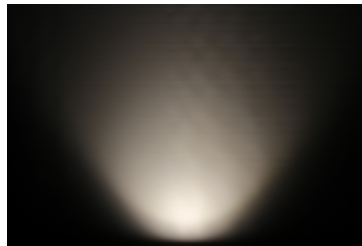

PHILIPS

LED Fortimo SLM L13 CoB
 FWHM Asymmetric
 Efficiency 80 %
 Peak intensity 1 cd/lm
 LEDs/each optic 1
 Light colour White
 Required components:
 C12292_LENA-STD-BASE-MEZ
 C11996_LENA-LENS

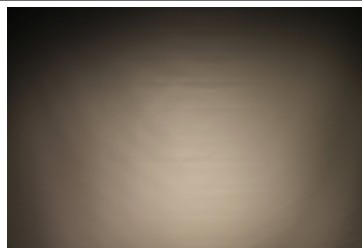

PHILIPS

LED Fortimo SLM L13 CoB
 FWHM Asymmetric
 Efficiency 85 %
 Peak intensity 1.1 cd/lm
 LEDs/each optic 1
 Light colour White
 Required components:
 C12292_LENA-STD-BASE-MEZ

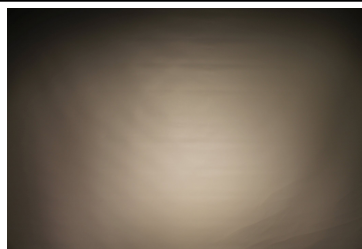

PHOTOMETRIC DATA (MEASURED):

PHILIPS

LED Fortimo SLM L15 CoB
 FWHM Asymmetric
 Efficiency 85 %
 Peak intensity 1.1 cd/lm
 LEDs/each optic 1
 Light colour White
 Required components:
 C12292_LENA-STD-BASE-MEZ

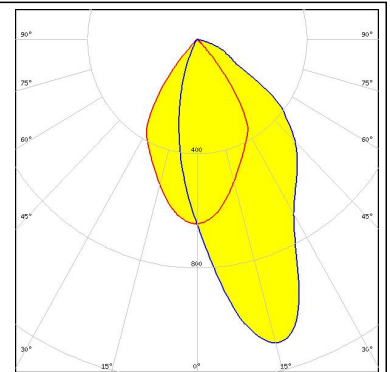

PHILIPS

LED Fortimo SLM L15 CoB
 FWHM Asymmetric
 Efficiency 80 %
 Peak intensity 0.9 cd/lm
 LEDs/each optic 1
 Light colour White
 Required components:
 C12292_LENA-STD-BASE-MEZ
 C11996_LENA-LENS

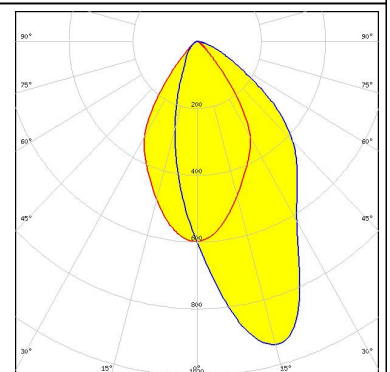
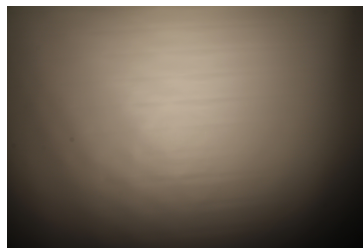

PHILIPS

LED Fortimo SLM L19 CoB
 FWHM Asymmetric
 Efficiency 85 %
 Peak intensity 1 cd/lm
 LEDs/each optic 1
 Light colour White
 Required components:
 C12692_LENA-STD-BASE-CLL040

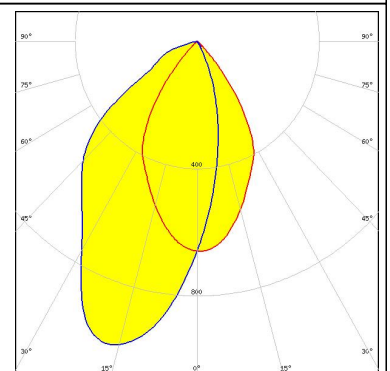
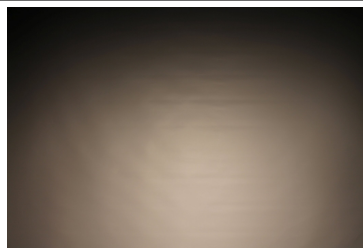

PHILIPS

LED Fortimo SLM L19 CoB
 FWHM Asymmetric
 Efficiency 80 %
 Peak intensity 0.9 cd/lm
 LEDs/each optic 1
 Light colour White
 Required components:
 C12692_LENA-STD-BASE-CLL040
 C11996_LENA-LENS

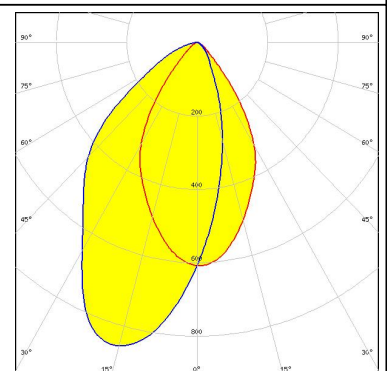
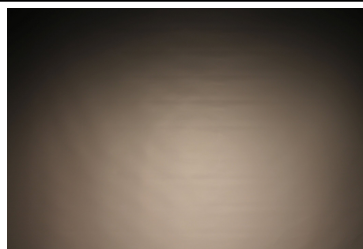

PHOTOMETRIC DATA (MEASURED):

PHILIPS

LED Fortimo SLM L23 CoB
 FWHM Asymmetric
 Efficiency 80 %
 Peak intensity 0.8 cd/lm
 LEDs/each optic 1
 Light colour White
 Required components:
 C12692_LENA-STD-BASE-CLL040
 C11996_LENA-LENS

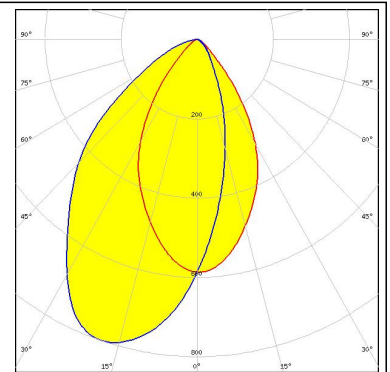
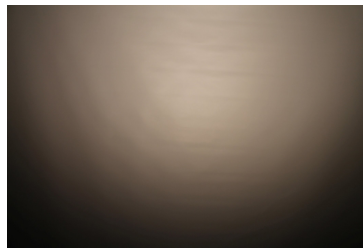

PHILIPS

LED Fortimo SLM L23 CoB
 FWHM Asymmetric
 Efficiency 85 %
 Peak intensity 0.9 cd/lm
 LEDs/each optic 1
 Light colour White
 Required components:
 C12692_LENA-STD-BASE-CLL040

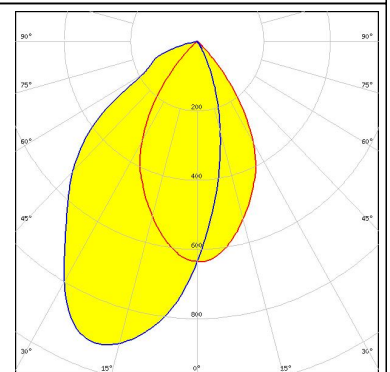
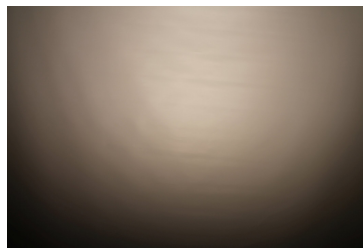

SAMSUNG

LED LC016D / LC019D / LC026D / LC033D
 FWHM Asymmetric
 Efficiency 89 %
 Peak intensity 1.1 cd/lm
 LEDs/each optic 1
 Light colour White
 Required components:
 C12691_LENA-STD-BASE-CLL030

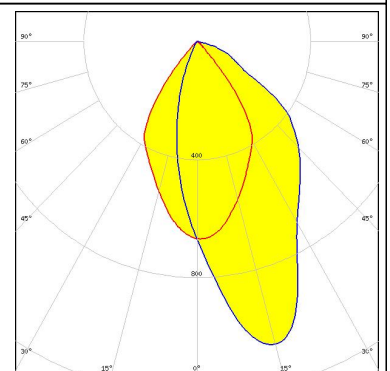

SAMSUNG

LED LC016D / LC019D / LC026D / LC033D
 FWHM Asymmetric
 Efficiency 84 %
 Peak intensity 0.9 cd/lm
 LEDs/each optic 1
 Light colour White
 Required components:
 C12691_LENA-STD-BASE-CLL030
 C11996_LENA-LENS

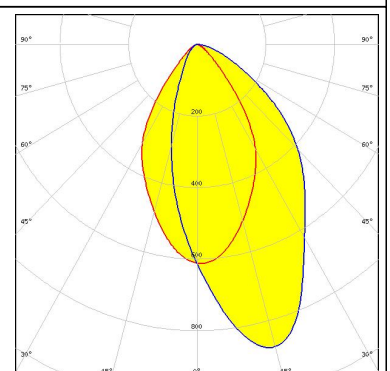

PHOTOMETRIC DATA (MEASURED):

SHARP

LED Mega Zenigata (GW6DME)
 FWHM Asymmetric
 Efficiency 75 %
 Peak intensity 0.8 cd/lm
 LEDs/each optic 1
 Light colour White
 Required components:
 C12292_LENA-STD-BASE-MEZ
 C11996_LENA-LENS

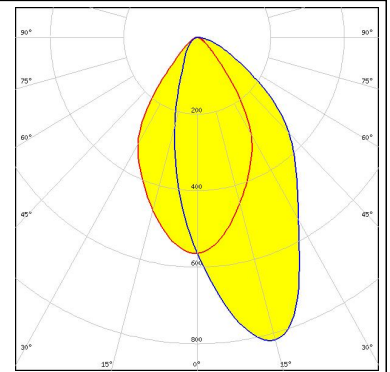

SHARP

LED Mega Zenigata (GW6DME)
 FWHM Asymmetric
 Efficiency 80 %
 Peak intensity 1 cd/lm
 LEDs/each optic 1
 Light colour White
 Required components:
 C12292_LENA-STD-BASE-MEZ

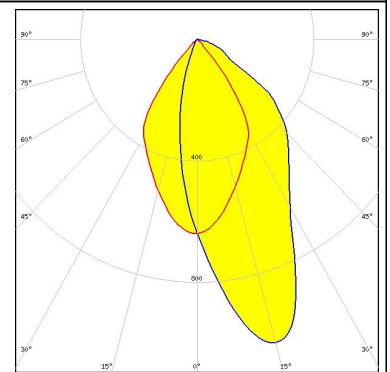

TRIDONIC

LED SLE G7 LES15
 FWHM Asymmetric
 Efficiency 89 %
 Peak intensity 1.1 cd/lm
 LEDs/each optic 1
 Light colour White
 Required components:
 C12691_LENA-STD-BASE-CLL030

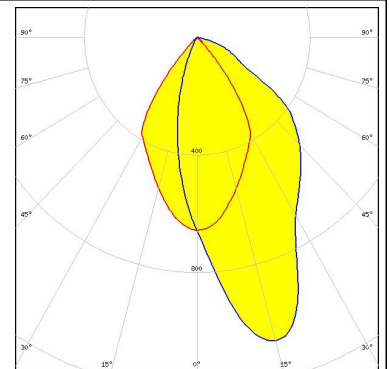

TRIDONIC

LED SLE G7 LES17 H
 FWHM Asymmetric
 Efficiency 87 %
 Peak intensity 1 cd/lm
 LEDs/each optic 1
 Light colour White
 Required components:
 C14547_LENA-ADAPTER-B

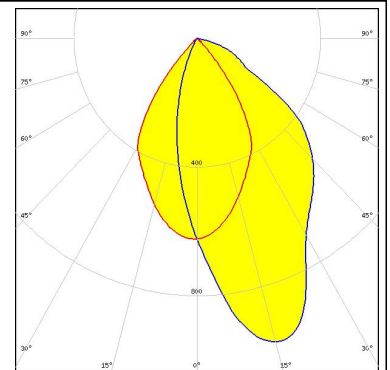

PHOTOMETRIC DATA (MEASURED):

TRIDONIC

LED SLE G7 LES21 H
FWHM Asymmetric
Efficiency 86 %
Peak intensity 0.9 cd/lm
LEDs/each optic 1
Light colour White
Required components:
C14547_LENA-ADAPTER-B

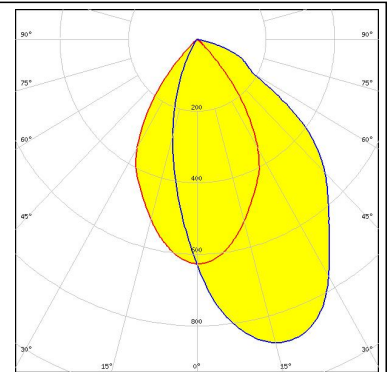

XICATO

LED XOB 14.5 mm
FWHM Asymmetric
Efficiency 91 %
Peak intensity 1.2 cd/lm
LEDs/each optic 1
Light colour White
Required components:
C12691_LENA-STD-BASE-CLL030

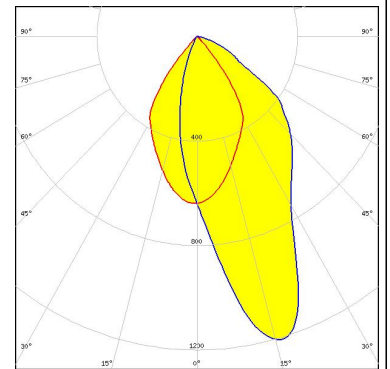
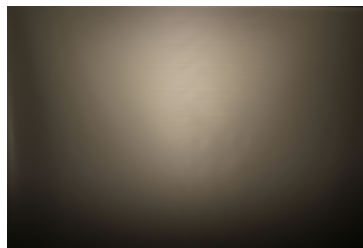

PHOTOMETRIC DATA (SIMULATED):

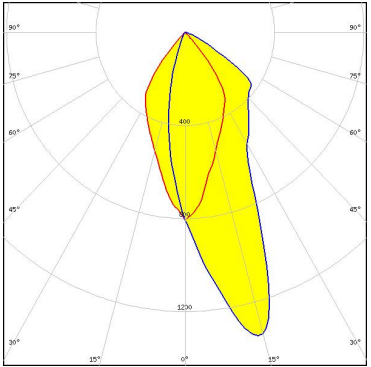
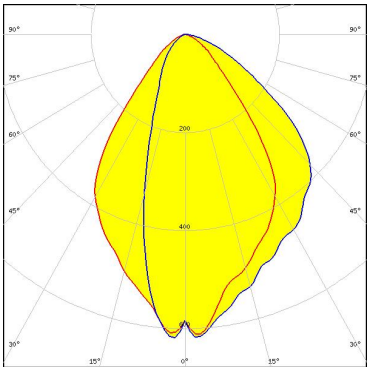
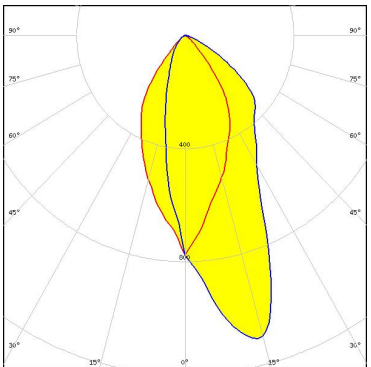
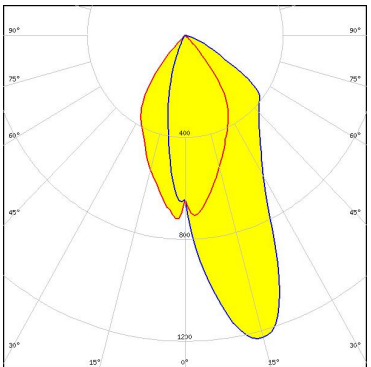
<p>bridgelux.</p> <p>LED V10 Gen7 FWHM Asymmetric Efficiency 88 % Peak intensity 1.4 cd/lm LEDs/each optic 1 Light colour White Required components: C13868_LENA-STD-BASE-VERO13-18 Bender Wirth: 486 Typ L1</p>	
<p>bridgelux.</p> <p>LED V10 Gen7 FWHM Asymmetric Efficiency 81 % Peak intensity 0.6 cd/lm LEDs/each optic 1 Light colour White Required components: C13868_LENA-STD-BASE-VERO13-18 C11996_LENA-LENS Bender Wirth: 486 Typ L1</p>	
<p>bridgelux.</p> <p>LED V10 Gen7 FWHM Asymmetric Efficiency 84 % Peak intensity 1.1 cd/lm LEDs/each optic 1 Light colour White Required components: C13868_LENA-STD-BASE-VERO13-18 C11996_LENA-LENS Bender Wirth: 486 Typ L1</p>	
<p>bridgelux.</p> <p>LED V13 Gen7 FWHM Asymmetric Efficiency 88 % Peak intensity 1.2 cd/lm LEDs/each optic 1 Light colour White Required components: C13868_LENA-STD-BASE-VERO13-18 Bender Wirth: 477 Typ L1</p>	

PHOTOMETRIC DATA (SIMULATED):

<p>bridgelux.</p> <p>LED V13 Gen7 FWHM Asymmetric Efficiency 88 % Peak intensity 1.1 cd/lm LEDs/each optic 1 Light colour White</p> <p>Required components: C13868_LENA-STD-BASE-VERO13-18 C11996_LENA-LENS Bender Wirth: 477 Typ L1</p>	
<p>bridgelux.</p> <p>LED V13 Gen7 FWHM Asymmetric Efficiency 84 % Peak intensity 1 cd/lm LEDs/each optic 1 Light colour White</p> <p>Required components: C13868_LENA-STD-BASE-VERO13-18 C11996_LENA-LENS Bender Wirth: 477 Typ L1</p>	
<p>bridgelux.</p> <p>LED V13 Gen7 FWHM Asymmetric Efficiency 88 % Peak intensity 1.3 cd/lm LEDs/each optic 1 Light colour White</p> <p>Required components: IDEAL: 50-2103CT + 50-2100LN</p>	
<p>bridgelux.</p> <p>LED V13 Gen7 FWHM Asymmetric Efficiency 85 % Peak intensity 1.1 cd/lm LEDs/each optic 1 Light colour White</p> <p>Required components: C11996_LENA-LENS</p>	

PHOTOMETRIC DATA (SIMULATED):



LED CXA/B 30xx
 FWHM Asymmetric
 Efficiency 85 %
 Peak intensity 1.1 cd/lm
 LEDs/each optic 1
 Light colour White
 Required components:
 IDEAL: 50-2234C + 50-2100LN

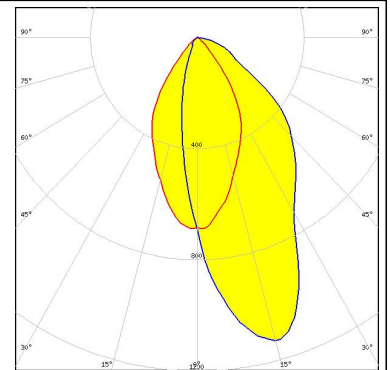

LED CXA/B 30xx
 FWHM Asymmetric
 Efficiency 81 %
 Peak intensity 1 cd/lm
 LEDs/each optic 1
 Light colour White
 Required components:
 C11996_LENA-LENS
 IDEAL: 50-2234C + 50-2100LN

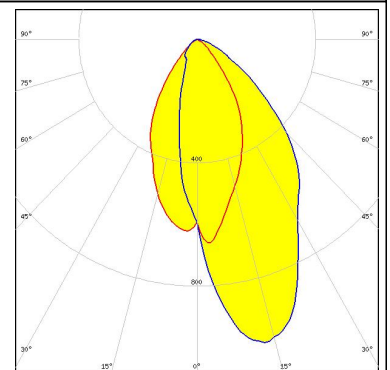

LED LUXEON CoB 1204/1205
 FWHM Asymmetric
 Efficiency 93 %
 Peak intensity 1.7 cd/lm
 LEDs/each optic 1
 Light colour White
 Required components:
 C12292_LENA-STD-BASE-MEZ

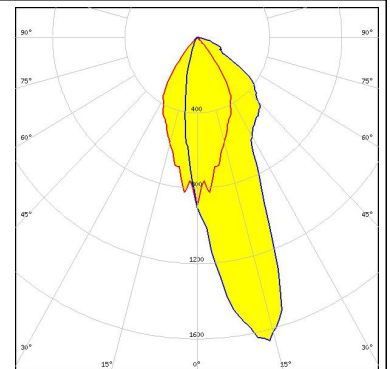

LED LUXEON CoB 1204/1205
 FWHM Asymmetric
 Efficiency 88 %
 Peak intensity 1.1 cd/lm
 LEDs/each optic 1
 Light colour White
 Required components:
 C12292_LENA-STD-BASE-MEZ
 C11996_LENA-LENS

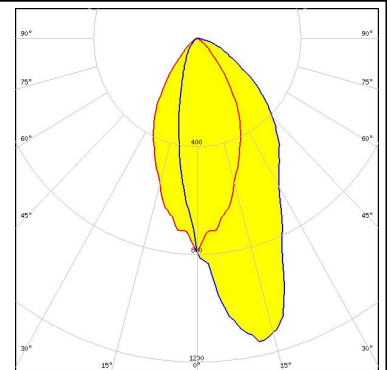

PHOTOMETRIC DATA (SIMULATED):

LUMILEDS

LED LUXEON CoB 1208
 FWHM Asymmetric
 Efficiency 92 %
 Peak intensity 1.6 cd/lm
 LEDs/each optic 1
 Light colour White
 Required components:
 C12292_LENA-STD-BASE-MEZ

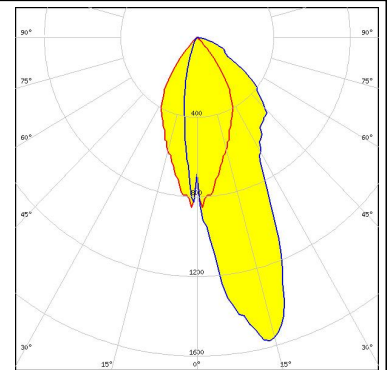

LUMILEDS

LED LUXEON CoB 1208
 FWHM Asymmetric
 Efficiency 87 %
 Peak intensity 1.1 cd/lm
 LEDs/each optic 1
 Light colour White
 Required components:
 C12292_LENA-STD-BASE-MEZ
 C11996_LENA-LENS

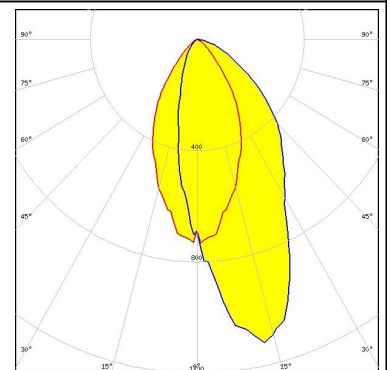

LUMINUS

LED CxM-14 (19x19)
 FWHM Asymmetric
 Efficiency 87 %
 Peak intensity 0.5 cd/lm
 LEDs/each optic 1
 Light colour White
 Required components:
 C13868_LENA-STD-BASE-VERO13-18
 C11996_LENA-LENS
 Bender Wirth: 433 Typ L1

LUMINUS

LED CxM-14 (19x19)
 FWHM Asymmetric
 Efficiency 90 %
 Peak intensity 1.1 cd/lm
 LEDs/each optic 1
 Light colour White
 Required components:
 C13868_LENA-STD-BASE-VERO13-18
 Bender Wirth: 433 Typ L1

PHOTOMETRIC DATA (SIMULATED):



LED CxM-14 (19x19)
FWHM Asymmetric
Efficiency 85 %
Peak intensity 0.9 cd/lm
LEDs/each optic 1
Light colour White
Required components:
 C13868_LENA-STD-BASE-VERO13-18
 C11996_LENA-LENS
 Bender Wirth: 433 Typ L1



LED Soleriq S15
FWHM Asymmetric
Efficiency 88 %
Peak intensity 1.2 cd/lm
LEDs/each optic 1
Light colour White
Required components:
 C12691_LENA-STD-BASE-CLL030

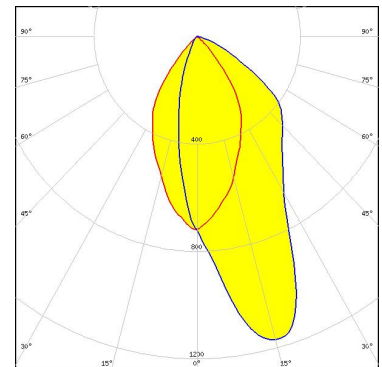



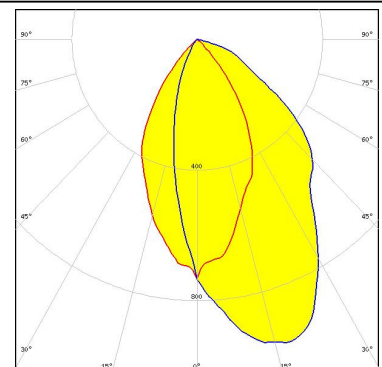

LED LC040D / LC060D / LC080D
FWHM Asymmetric
Efficiency 86 %
Peak intensity 1 cd/lm
LEDs/each optic 1
Light colour White
Required components:
 C12692_LENA-STD-BASE-CLL040

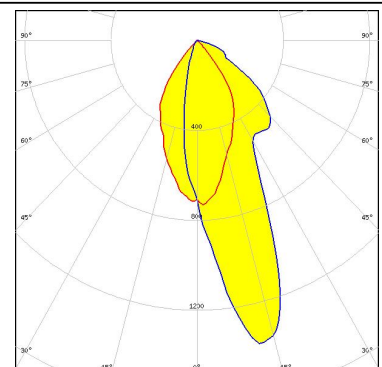

LED ZC12/18
FWHM Asymmetric
Efficiency 86 %
Peak intensity 1.4 cd/lm
LEDs/each optic 1
Light colour White
Required components:
 C12691_LENA-STD-BASE-CLL030

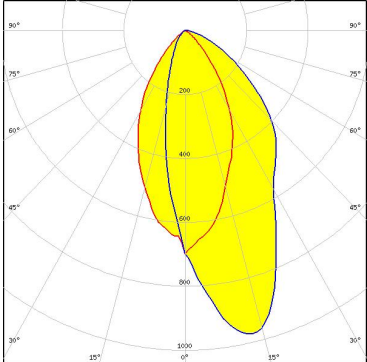

PHOTOMETRIC DATA (SIMULATED):

<p> SEUL SEMICONDUCTOR</p> <p>LED ZC12/18 FWHM Asymmetric Efficiency 87 % Peak intensity 0.5 cd/lm LEDs/each optic 1 Light colour White</p> <p>Required components: C13868_LENA-STD-BASE-VERO13-18 C11996_LENA-LENS Bender Wirth: 433 Typ L1</p>	
<p> SEUL SEMICONDUCTOR</p> <p>LED ZC12/18 FWHM Asymmetric Efficiency 90 % Peak intensity 1.1 cd/lm LEDs/each optic 1 Light colour White</p> <p>Required components: C13868_LENA-STD-BASE-VERO13-18 Bender Wirth: 433 Typ L1</p>	
<p> SEUL SEMICONDUCTOR</p> <p>LED ZC12/18 FWHM Asymmetric Efficiency % LEDs/each optic 1 Light colour White</p> <p>Required components: C12691_LENA-STD-BASE-CLL030 C11996_LENA-LENS</p>	
<p> SEUL SEMICONDUCTOR</p> <p>LED ZC12/18 FWHM Asymmetric Efficiency 85 % Peak intensity 0.9 cd/lm LEDs/each optic 1 Light colour White</p> <p>Required components: C13868_LENA-STD-BASE-VERO13-18 C11996_LENA-LENS Bender Wirth: 433 Typ L1</p>	

PHOTOMETRIC DATA (SIMULATED):

SHARP

LED Mega Zenigata (GW5DGC)
FWHM Asymmetric
Efficiency %
LEDs/each optic 1
Light colour White
Required components:
C12292_LENA-STD-BASE-MEZ

SHARP

LED Mega Zenigata (GW5DGC)
FWHM Asymmetric
Efficiency %
LEDs/each optic 1
Light colour White
Required components:
C12292_LENA-STD-BASE-MEZ
C11996_LENA-LENS

GENERAL INFORMATION:

NOTE: The typical beam angle will be changed by different color, chip size and chip position tolerance. The typical total beam angle is the full angle measured where the luminous intensity is half of the peak value.

Due to use of high power COB's with this product, special attention to proper thermal design is highly recommended. LEDiL has no liability for direct, indirect or consecutive damages arising from the LEDiL products being used outside of the recommended temperature range.

MATERIALS:

As part of our continuous research and improvement processes, and to ensure the best possible quality and availability of our products, LEDiL reserves the right to change material grades without notice.

PRODUCT DATA USER AGREEMENT AND DISCLAIMER:

The measured data in the provided downloadable LEDiL Product Datasheets and Mechanical 2D-Drawings is rounded and provided as reference for planning. LEDiL Oy's optical specifications have been verified by conducting performance testing of the products in accordance with the company's quality system. The reported data are averaged results of multiple measurements with typical variation. LEDiL Oy reserves the right to without prior notification make changes and improvements to its products.

LEDiL Oy assumes neither warranty, nor guarantee nor any other liability of any kind for the contents and correctness of the provided data. The provided data has been generated with highest diligence but the provided data may in reality not represent the complete possible variation range of all intrinsic parameters. Therefore, in certain cases a deviation from the provided data could occur.

LEDiL Oy reserves the right to undertake technical changes of its products without further notification which could lead to changes in the provided data. LEDiL Oy assumes no liability of any kind for the possible deviation from any provided data or any other damage resulting from the usage of the provided data.

The user agrees to this disclaimer and user agreement with the download or usage of the provided files.

LEDiL Oy

Joensuunkatu 13
FI-24240 SALO
Finland

LEDiL Inc.

228 West Page Street
Suite D
Sycamore IL 60178
USA

Local sales and technical support

[www.ledil.com/
where_to_buy](http://www.ledil.com/where_to_buy)

Shipping locations

Salo, Finland
Hong Kong, China

Distribution Partners

[www.ledil.com/
where_to_buy](http://www.ledil.com/where_to_buy)



**Стандарт
Электрон
Связь**

Мы молодая и активно развивающаяся компания в области поставок электронных компонентов. Мы поставляем электронные компоненты отечественного и импортного производства напрямую от производителей и с крупнейших складов мира.

Благодаря сотрудничеству с мировыми поставщиками мы осуществляем комплексные и плановые поставки широчайшего спектра электронных компонентов.

Собственная эффективная логистика и склад в обеспечивает надежную поставку продукции в точно указанные сроки по всей России.

Мы осуществляем техническую поддержку нашим клиентам и предпродажную проверку качества продукции. На все поставляемые продукты мы предоставляем гарантию .

Осуществляем поставки продукции под контролем ВП МО РФ на предприятия военно-промышленного комплекса России , а также работаем в рамках 275 ФЗ с открытием отдельных счетов в уполномоченном банке. Система менеджмента качества компании соответствует требованиям ГОСТ ISO 9001.

Минимальные сроки поставки, гибкие цены, неограниченный ассортимент и индивидуальный подход к клиентам являются основой для выстраивания долгосрочного и эффективного сотрудничества с предприятиями радиоэлектронной промышленности, предприятиями ВПК и научно-исследовательскими институтами России.

С нами вы становитесь еще успешнее!

Наши контакты:

Телефон: +7 812 627 14 35

Электронная почта: sales@st-electron.ru

Адрес: 198099, Санкт-Петербург,
Промышленная ул, дом № 19, литера Н,
помещение 100-Н Офис 331