

ULTRA MINIATURE SMD VC/TCXO



2.5 X 2.0 X 0.9mm



RoHS
Compliant

ASVTX-12/ASTX-12

Moisture Sensitivity Level (MSL) –1

FEATURES:

- Ultra miniature and low height 0.9mm.
- Low current consumption 2.5mA.
- Vc function corresponds to PLL circuits.
- Suitable for RoHS reflow profile.
- Low phase noise.

APPLICATIONS:

- Cellular and cordless phones.
- Standard OSC for exact equipment.
- Mobile communication equipment.
- Portable radio equipment.
- Personal Digital Assistants (PDAs).
- Portable music players.

STANDARD SPECIFICATIONS:

Parameters	Minimum	Typical	Maximum	Units	Notes
Frequency Range	13		52	MHz	
Standard Frequencies	13, 16.368, 16.369, 19.2, 26, 38.4, 40, 52			MHz	
Operating Temperature	-30		+85	°C	See option (Table 1)
Storage Temperature	-40		+85	°C	
Frequency Stability $\Delta f/f_0$ vs Tolerance (@+25°C)	-2.0		+2.0	ppm	+25°C, Vcon=1.4V After 2 time reflow
Temperature (ref. to +25°C)	-1.0		+1.0		See option (Table 1)
Supply Voltage Change (Vdd±5%)	-0.2		+0.2		
Load Change (Z _L ±10%)	-0.2		+0.2		
Control Voltage (Vcon) (ASVTX-12 only)	+0.4		+2.4	V	Option A
	+0.4		+2.4		Option B
	+0.4		+2.4		Option C
	+0.3		+1.5		Option D
Supply Voltage (Vcc)	+2.85	+3.0	+3.15	V	Option A
	+2.66	+2.8	+2.94		Option B
	+2.375	+2.5	+2.625		Option C
	+1.71	+1.8	+1.89		Option D
Aging (first year @+25±2°C)	-1.0		+1.0	ppm	
Supply Current (Icc)			2.0	mA	13MHz ≤ Fo < 26MHz
			2.5	mA	26MHz ≤ Fo ≤ 52MHz
Startup Time			2.0	ms	
Frequency Tuning Range (ASVTX-12 only)	±5.0		±9.5	ppm	
Vcon Input Impedance (ASVTX-12 only)	500			kΩ	
Frequency Tuning Transition	Positive				
Output Voltage	0.8			Vp-p	
Harmonics			-5.0	dBc	
Load	10kΩ//10pF				
Waveform	Clipped Sine Wave				
Phase Noise @ 19.2MHz					
100Hz offset from the carrier		-115	-100	dB/Hz	
1kHz offset from the carrier		-135	-125		
10kHz offset from the carrier		-150	-140		

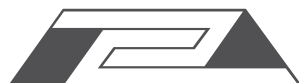

ULTRA MINIATURE SMD VC/TCXO



2.5 X 2.0 X 0.9mm



RoHS
Compliant

ASVTX-12/ASTX-12

OPTIONS & PART IDENTIFICATION: (left blank if standard)

ASVTX-12 or ASTX-12 - - MHz - -

Vdd (V)
A: 3.0V±5%
B: 2.8V±5%
C: 2.5V±5%
D: 1.8V±5%

Frequency in MHz
Please specify the frequency in MHz. e.g. 19.200MHz 26.000MHz

Packaging
T: 1,000pcs/reel

Table 1: Frequency Stability vs Operating Temperature

	±0.5ppm	±1.0ppm	±1.5ppm	±2.0ppm	±2.5ppm
0°C ~ +55°C	D05	D10	D15	D20	D25
-10°C ~ +60°C	E05	E10	E15	E20	E25
0°C ~ +70°C	F05	F10	F15	F20	F25
-20°C ~ +70°C	G05	G10	G15	G20	G25
-30°C ~ +85°C	H05*	H10	H15	STD (Blank)	H25
-40°C ~ +85°C		I10*	I15	I20	I25

*Please contact Abracon for availability

RECOMMENDED TEST CIRCUIT

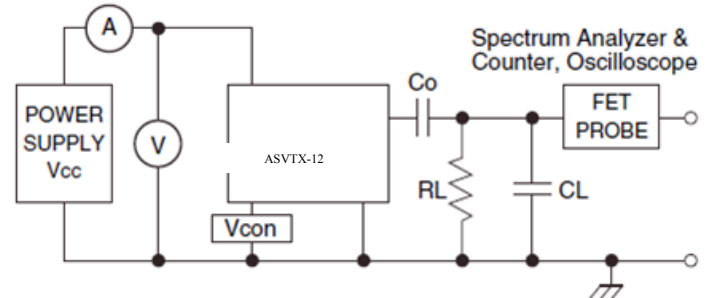
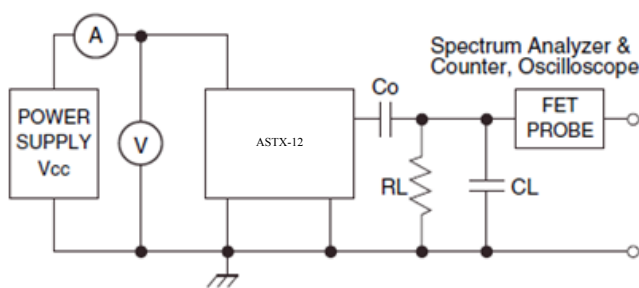

RL=10kΩ±10% CL=10pF±10%
 • CL include Probe Capacitance
 Co: DC Cut Capacitance

ULTRA MINIATURE SMD VC/TCXO



2.5 X 2.0 X 0.9mm

ASVTX-12/ASTX-12



OUTLINE DIMESIONS:

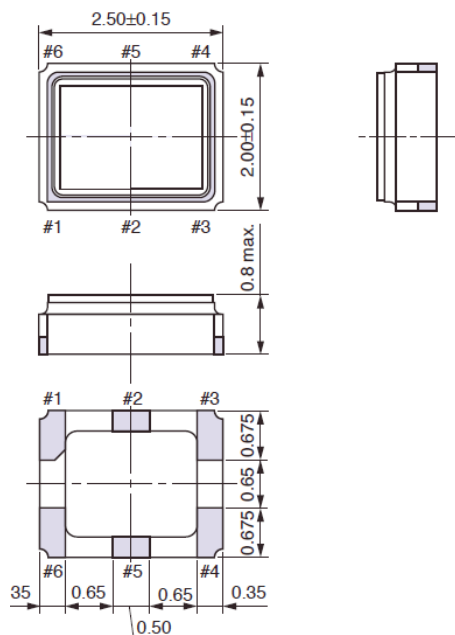

Recommended Land Pattern

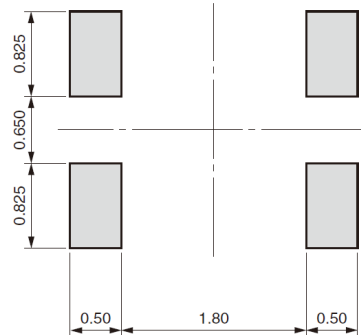

	Pin Configuration
#1 pin	GND
#3 pin	GND
#4 pin	OUTPUT
#6 pin	Vcc
#2/5 pin	N.C.

	Pin Configuration
#1 pin	Vcon
#3 pin	GND
#4 pin	OUTPUT
#6 pin	Vcc
#2/5 pin	N.C.

ASTX-12 TCXO

ASVTX-12 VCTCXO

Note1:

It is recommended that a by-pass capacitor of 0.01uF value be placed between pin #6 and pin #3 and an AC-coupling capacitor of the same value be placed in series with pin#4 for optimal performance.

For ASTX, please connect pin #1 and #3 to GND.

Note2:

Pin#2 and Pin#5 should be left floating (No Connect = N.C.)

Dimensions: mm

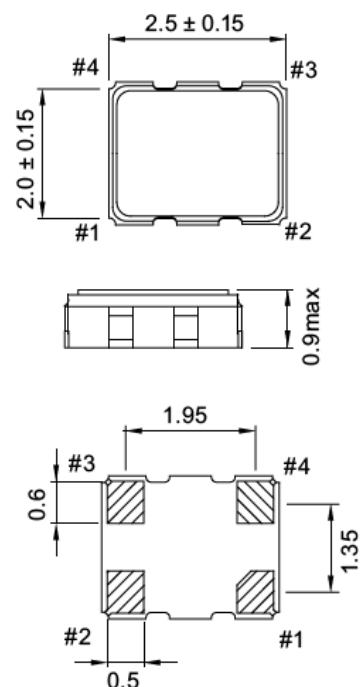

Recommended Land Pattern

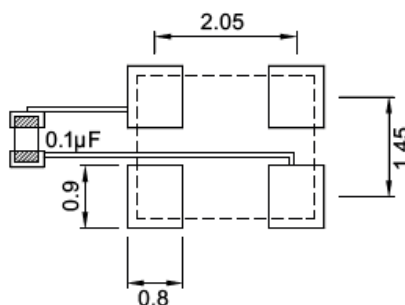

PIN	FUNCTION	
	ASVTX	ASTX
1	Vcon	GND
2	GND	
3	OUTPUT	
4	Vcc	

Note:

It is recommended that a by-pass capacitor of 0.1uF value be placed between pin #2 and pin #4 and an AC-coupling capacitor of the same value be placed in series with pin#3 for optimal performance.

Dimensions: mm

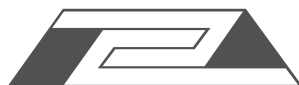

ULTRA MINIATURE SMD VC/TCXO



2.5 X 2.0 X 0.9mm



RoHS
Compliant

ASVTX-12/ASTX-12

REFLOW PROFILE

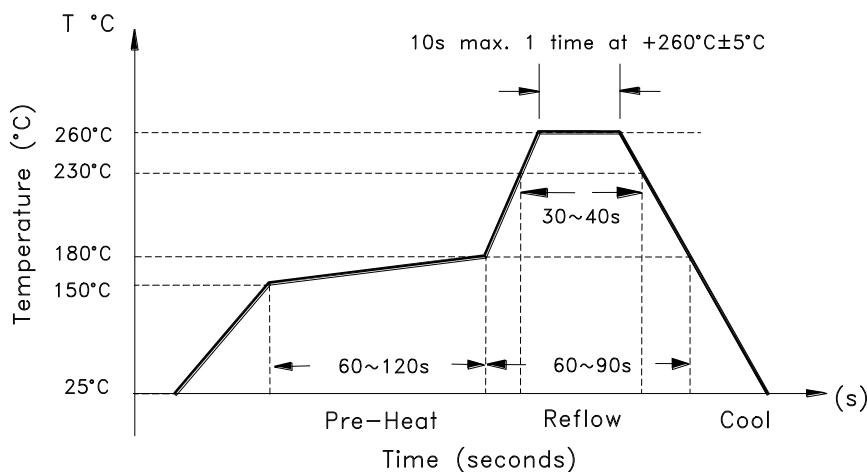

TAPE & REEL:

T: 1,000pcs/Reel

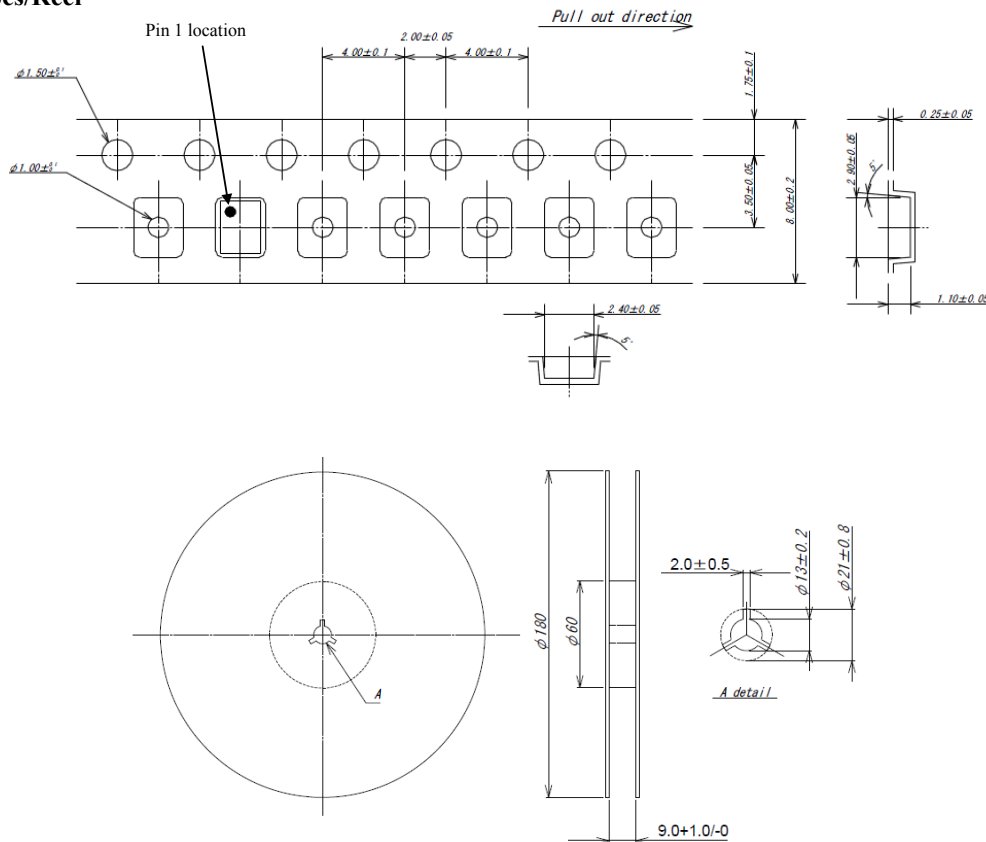

Dimensions: mm

ATTENTION: Abracon Corporation's products are COTS – Commercial-Off-The-Shelf products; suitable for Commercial, Industrial and, where designated, Automotive Applications. Abracon's products are not specifically designed for Military, Aviation, Aerospace, Life-dependant Medical applications or any application requiring high reliability where component failure could result in loss of life and/or property. For applications requiring high reliability and/or presenting an extreme operating environment, written consent and authorization from Abracon Corporation is required. Please contact Abracon Corporation for more information.

ABRACON IS
ISO9001:2008
CERTIFIED



Visit www.abracon.com for Terms & Conditions of Sale **Revised: 12.18.12**
30332 Esperanza, Rancho Santa Margarita, California 92688
tel 949-546-8000 | fax 949-546-8000 | www.abracon.com



Стандарт Электрон Связь

Мы молодая и активно развивающаяся компания в области поставок электронных компонентов. Мы поставляем электронные компоненты отечественного и импортного производства напрямую от производителей и с крупнейших складов мира.

Благодаря сотрудничеству с мировыми поставщиками мы осуществляем комплексные и плановые поставки широчайшего спектра электронных компонентов.

Собственная эффективная логистика и склад в обеспечивает надежную поставку продукции в точно указанные сроки по всей России.

Мы осуществляем техническую поддержку нашим клиентам и предпродажную проверку качества продукции. На все поставляемые продукты мы предоставляем гарантию .

Осуществляем поставки продукции под контролем ВП МО РФ на предприятия военно-промышленного комплекса России , а также работаем в рамках 275 ФЗ с открытием отдельных счетов в уполномоченном банке. Система менеджмента качества компании соответствует требованиям ГОСТ ISO 9001.

Минимальные сроки поставки, гибкие цены, неограниченный ассортимент и индивидуальный подход к клиентам являются основой для выстраивания долгосрочного и эффективного сотрудничества с предприятиями радиоэлектронной промышленности, предприятиями ВПК и научно-исследовательскими институтами России.

С нами вы становитесь еще успешнее!

Наши контакты:

Телефон: +7 812 627 14 35

Электронная почта: sales@st-electron.ru

Адрес: 198099, Санкт-Петербург,
Промышленная ул, дом № 19, литера Н,
помещение 100-Н Офис 331