

STARTERKIT ST7

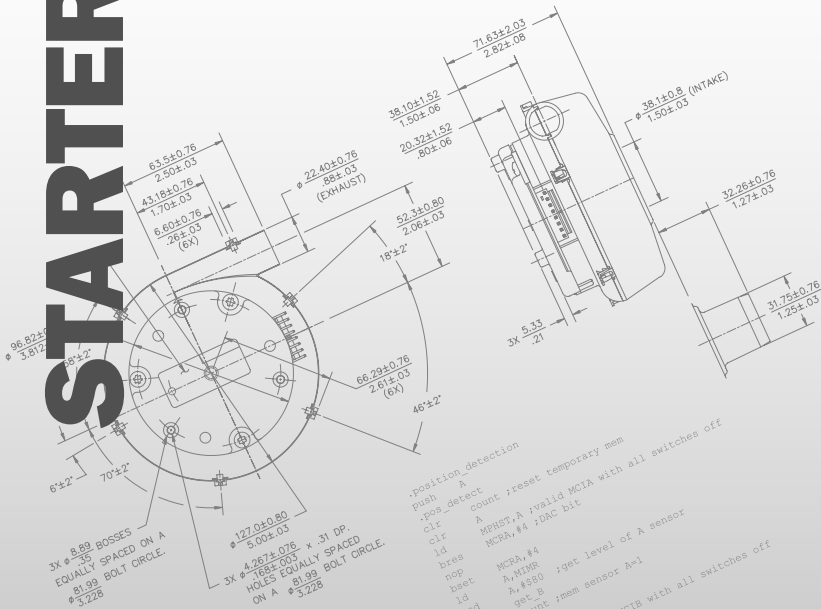

BRUSHLESS MOTOR CONTROL



```
.position_detection  
push A  
pos_detect  
clr count ;reset temporary mem  
clr A  
MCRST,A ;valid MCR1 with all switches off  
ld MCRB,#4 ;DAC bit  
nop  
bres MCRB,#4  
ld A,MING  
and A,#580 ;get level of A sensor  
ld count ;mem sensor A=1  
inc count  
;get_B A,#540  
ld MCRST,A;valid MCRB with all switches off  
ld MCRB,#4 ;DAC bit  
nop  
bres MCRB,#4  
ld A,MING  
and A,#580;get level of B sensor  
ld count  
inc count ;mem sensor B=1  
;get_C A,#580  
ld MCRST,A;valid MCR1C with all switches off  
ld MCRB,#4 ;DAC bit  
nop  
bres MCRB,#4  
ld A,MING ;get level of C sensor  
and A,#580 ;mem sensor B=C-1
```

SofTec
MICROSYSTEMS
Development Tools
for the EmbeddedWorld

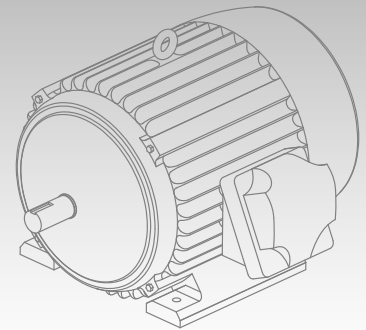

User's Manual

AK-ST7FMC

Starter Kit for STMicroelectronics ST7FMC Motor Control Device

User's Manual

Revision 1.0



Copyright © 2004 SofTec Microsystems®

DC00718

We want your feedback!

SofTec Microsystems is always on the look-out for new ways to improve its Products and Services. For this reason feedback, comments, suggestions or criticisms, however small, are always welcome.

SofTec Microsystems

E-mail (general information): info@softecmicro.com

E-mail (marketing department): marketing@softecmicro.com

E-mail (technical support): support@softecmicro.com

Web: <http://www.softecmicro.com>

Important

SofTec Microsystems reserves the right to make improvements to the AK-ST7FMC Starter Kit, its documentation and software routines, without notice. Information in this manual is intended to be accurate and reliable. However, SofTec Microsystems assumes no responsibility for its use; nor for any infringements of rights of third parties which may result from its use.

SOFTEC MICROSYSTEMS WILL NOT BE LIABLE FOR DAMAGES RESULTING FROM LOSS OF DATA, PROFITS, USE OF PRODUCTS, OR INCIDENTAL OR CONSEQUENTIAL DAMAGES, EVEN IF ADVISED OF THE POSSIBILITY THEREOF.

Trademarks

STMicroelectronics is a registered trademark of STMicroelectronics, Inc.

Metrowerks and CodeWarrior are trademarks or registered trademarks of Metrowerks Corp.

Microsoft and Windows are trademarks or registered trademarks of Microsoft Corporation.

PC is a registered trademark of International Business Machines Corporation.

Other products and company names listed are trademarks or trade names of their respective companies.

Contents

0 Before Starting 11

- 0.1 Safety Warnings 11
 - 0.1.1 *General* 11
 - 0.1.2 *Intended Use* 11
 - 0.1.3 *Operation* 11
 - 0.1.4 *Important Notice to Users* 12
- 0.2 Required Skills 12
- 0.3 Credits 12

1 Overview 15

- 1.1 What is the AK-ST7FMC Starter Kit? 15
- 1.2 ST7FMC Family Overview 16
- 1.3 The Brushless DC (BLDC) Motor 16
- 1.4 The AC Induction Motor 17
- 1.5 Recommended Reading 18
- 1.6 Software Upgrades 18
- 1.7 Troubleshooting 18
- 1.8 Getting Technical Support 19

2 AK-ST7FMC Components 21

- 2.1 Package Checklist 21
- 2.2 The Motor Control Board 22
- 2.3 The BLDC Motor 24
- 2.4 The In-Circuit Debugger/Programmer (inDART-STX) 24
- 2.5 The Optoisolation board 24
- 2.6 The “Alternate Z Sampling” Daughter Board 25

3 Getting Started for BLDC Motors 27

- 3.1 Introduction 27
- 3.2 Step-by-Step Tutorial 27
 - 3.2.1 *Tools Required* 27
 - 3.2.2 *Installing the Software* 28
 - 3.2.3 *Installing the Hardware* 28
 - 3.2.4 *Tutorial Steps* 29

4 Getting Started for AC Motors 33

- 4.1 Introduction 33
- 4.2 Step-by-Step Tutorial 33
 - 4.2.1 *Tools Required* 33
 - 4.2.2 *Installing the Software* 34
 - 4.2.3 *Installing the Hardware* 34
 - 4.2.4 *Tutorial Steps* 36

5 Connectors and Functions 39

- 5.1 Power Supply 39
 - 5.1.1 *Introduction* 39
 - 5.1.2 *Optoisolation Board Supply* 40
 - 5.1.3 *Power Supply Connectors Summary* 40
- 5.2 Push-Buttons and Potentiometer (Standalone Mode) 41
 - 5.2.1 *Introduction* 41
 - 5.2.2 *Preparing for Standalone Mode: General Notes* 41
 - 5.2.3 *Preparing for Standalone Mode: BLDC Motors* 42
 - 5.2.4 *Preparing for Standalone Mode: AC Motors* 46
 - 5.2.5 *Push-Buttons* 49
 - 5.2.6 *Potentiometers* 50
 - 5.2.7 *Standalone Mode: Driving a BLDC Motor* 50
 - 5.2.8 *Standalone Mode: Driving an AC Motor* 51
- 5.3 BLDC Motor Outputs and Feedback 52
 - 5.3.1 *Introduction* 52
 - 5.3.2 *Sensorless Mode (STMicroelectronics Method)* 53
 - 5.3.3 *Sensorless Mode (Standard Method)* 54
 - 5.3.4 *Sensor Mode* 54
- 5.4 AC Motor Outputs and Feedback 54
 - 5.4.1 *Open Loop* 54
 - 5.4.2 *Closed Loop* 54
- 5.5 ICC Connector 55
- 5.6 External Power Stage Connectors 55
- 5.7 RS-232 Connector 56
- 5.8 Summary of Jumper and Connector Settings 57
 - 5.8.1 *Jumpers Summary* 57
 - 5.8.2 *Connectors Summary/Pinout* 60
 - 5.8.3 *Jumper Settings for a BLDC Motor (Default)* 64
 - 5.8.4 *Jumper Settings for an AC Motor* 65

6 AK-ST7FMC Control Panel Features 67

- 6.1 Introduction 67

6.1.1	<i>Suggested BLDC Motor Learning Steps</i>	67
6.1.2	<i>Suggested AC Motor Learning Steps</i>	68
6.2	Motor Type Choice	69
6.3	BLDC Motor Parameters	69
6.3.1	<i>Main Motor Settings</i>	71
6.3.2	<i>Start-Up Settings</i>	73
6.3.3	<i>Real-Time Settings</i>	76
6.3.4	<i>Advanced Settings</i>	77
6.4	AC Motor Parameters	87
6.4.1	<i>Main Motor Settings</i>	88
6.4.2	<i>V/F Curve Settings</i>	89
6.4.3	<i>Start-Up Settings</i>	89
6.4.4	<i>Real-Time Settings</i>	90
6.4.5	<i>Advanced Settings</i>	91
7	Electrical Specifications	93

Index of Figures

- Figure 2.1: AK-ST7FMC Hardware Components 22
- Figure 2.2: Motor Control Board 23
- Figure 3.1: Motor Type Choice Dialog Box 29
- Figure 3.2: AK-ST7FMC Control Panel Main Window for BLDC Motors 30
- Figure 4.1: AK-ST7FMC Control Panel Main Window for AC Motors 37
- Figure 5.1: Power Supply Connectors 40
- Figure 5.2: BLDC Motor Closed Loop Parameters Collecting 43
- Figure 5.3: AC Motor Closed Loop Parameters Collecting: K_i , K_p 47
- Figure 5.4: AC Motor Closed Loop Parameters Collecting: Slip Frequency 47
- Figure 5.5: Push Buttons 49
- Figure 5.6: Potentiometers 50
- Figure 5.7: Motor Outputs and Feedback 53
- Figure 5.8: Motor Outputs and Feedback 55
- Figure 6.1: AK-ST7FMC Control Panel Main Window for BLDC Motors 70
- Figure 6.2: BLDC Motor Advanced Settings Dialog Box 78
- Figure 6.3: BLDC Motor: BEMF Sampling Methods 86
- Figure 6.4: AK-ST7FMC Control Panel Main Window for AC Motors 87
- Figure 6.5: AC Motor Advanced Settings Dialog Box 91

Index of Tables

Table 5.1: BLDC Motor Closed Loop Standalone Firmware Defines	44
Table 5.2: Option Bytes Settings for ST7FMC Programming	45
Table 5.3: AC Motor Closed Loop Standalone Firmware Defines	48
Table 5.4: Open and Closed Loop Standalone Controls for a BLDC Motor	51
Table 5.5: Open and Closed Loop Standalone Controls for an AC Motor	52
Table 5.6: Jumpers Summary	57
Table 5.7: Connectors Summary/Pinout	60
Table 5.8: Jumper Settings Example for a BLDC Motor	64
Table 5.9: Jumper Settings Example for an AC Motor	65
Table 6.1: AK-ST7FMC Control Panel: Motor Type Choice	69
Table 6.2: AK-ST7FMC Control Panel: BLDC Motor Main Settings	71
Table 6.3: AK-ST7FMC Control Panel: BLDC Motor Start-Up Settings	74
Table 6.4: AK-ST7FMC Control Panel: BLDC Motor Real-Time Settings	76
Table 6.5: AK-ST7FMC Control Panel: BLDC Motor Advanced Settings	79
Table 6.6: AK-ST7FMC Control Panel: AC Motor Main Settings	88
Table 6.7: AK-ST7FMC Control Panel: AC Motor V/F Curve Settings	89
Table 6.8: AK-ST7FMC Control Panel: AC Motor Start-Up Settings	89
Table 6.9: AK-ST7FMC Control Panel: AC Motor Real-Time Settings	90
Table 6.10: AK-ST7FMC Control Panel: AC Motor Advanced Settings	92
Table 7.1: Motor Control Board Electrical Specifications	93
Table 7.2: Optoisolation Board Electrical Specifications	93

0 Before Starting

0.1 Safety Warnings

0.1.1 General

In operation, the AK-ST7FMC Starter Kit has uninsulated wires, moving or rotating parts (when connected to a motor), as well as hot surfaces. In case of improper use, wrong installation or maloperation, there is danger of serious personal injury and damage to property. All operations, installation and maintenance are to be carried out by skilled technical personnel (national accident prevention rules must be observed).

When the Motor Control board is supplied with voltages greater than 30 V AC/DC, all of the board and components must be considered "hot", and any contact with the board must be avoided. The operator should stay away from the board as well (risk of projection of material in case of components destruction, especially when powering the board with high voltages). The rotating parts of motors are also a source of danger.

The AK-ST7FMC Starter Kit contains electrostatic sensitive components which may be damaged through improper use.

0.1.2 Intended Use

The AK-ST7FMC Starter Kit is made of components designed for demonstration purposes and must not be included in electrical installations or machinery. Instructions about the setup and use of the AK-ST7FMC Starter Kit must be strictly observed.

0.1.3 Operation

After disconnecting the board from the voltage supply, several parts and power terminals must not be touched immediately because of possible energized capacitors or hot surfaces.

0.1.4 Important Notice to Users

While every effort has been made to ensure the accuracy of all information in this document, SofTec Microsystems assumes no liability to any party for any loss or damage caused by errors or omissions or by statements of any kind in this document, its updates, supplements, or special editions, whether such errors are omissions or statements resulting from negligence, accident, or any other cause.

0.2 Required Skills

In order to profitably use the AK-ST7FMC Starter Kit, you should be acquainted with several skills, ranging from hardware design to software design. In particular, you should possess the following knowledge:

- Electrical motor knowledge;
- Programming knowledge (Assembly and C);
- Microcontroller systems;
- ST7 architecture knowledge.

0.3 Credits

The AK-ST7FMC Start Kit has been developed by SofTec Microsystems together with STMicroelectronics. In particular, the Motor Control board has been developed by STMicroelectronics. A special thanks goes to the following people for contributing to this project and manual with ideas, technical information, diagrams.

Mr. Matteo Borini (SofTec Microsystems)
Mr. Jean-Marie Charreton (STMicroelectronics)
Mr. Arnaud Julienne (STMicroelectronics)
Mr. Vincent Onde (STMicroelectronics)
Mr. Loris Pacquola (SofTec Microsystems)
Mr. Eric Payet (STMicroelectronics)
Mr. Piero Poletto (SofTec Microsystems)

Mr. Jawhar Turki (STMicroelectronics)

Mr. Thomas Vicenzotto (SofTec Microsystems)

0

This manual has been edited by Paolo Xausa (SofTec Microsystems).

1 Overview

1

1.1 What is the AK-ST7FMC Starter Kit?

The AK-ST7FMC Starter Kit is an integrated system designed to provide the user with a complete, ready-to-use motor control application. The Starter Kit is built around the STMicroelectronics ST7FMC microcontroller, which has a built-in, dedicated motor control peripheral. This peripheral is particularly suited to drive brushless motors (either induction or permanent magnet types). The Starter Kit demonstrates how effectively the ST7FMC family of microcontrollers can be used in real-world motor control applications.

The Starter Kit is composed of a Motor Control board, a three-phase, permanent-magnet, brushless DC (BLDC) motor, plus an in-circuit debugger board and an Optoisolation board.

The Motor Control board has a built-in power stage and is capable of directly driving both AC and DC motors.

The Starter Kit can be used in two ways:

1. **For demonstration purposes.** Connect your own motor and drive it. A graphical user interface (AK-ST7FMC Control Panel) is provided, which allows you to change all of the driving parameters.
2. **For user application development.** A complete, integrated development environment is provided, which allows you to write your own software, download it to the ST7FMC microcontroller and debug it.



Caution: *The AK-ST7FMC Starter Kit should only be used by engineers and technicians who are experienced in power electronics.*

1.2 ST7FMC Family Overview

The ST7FMC microcontroller family is designed for mid-range applications with a Motor Control dedicated peripheral. All devices are based on a common industry-standard 8-bit core, featuring an enhanced instruction set and are available with FLASH memory.

The ST7 Motor Controller peripheral (MTC) can be seen as a three-phase, pulse-width modulator multiplexed on six output channels and a Back Electromotive Force (BEMF) zero-crossing detector for sensorless control of Permanent Magnet Brushless Direct Current (BLDC) motors.

The MTC is particularly suited to driving brushless motors (either induction or permanent magnet types) and supports operating modes like:

- Commutation step control with motor voltage regulation and current limitation.
- Commutation step control with motor current regulation, i.e. direct torque control.
- Position sensor or sensorless motor phase commutation control (six-step mode).
- BEMF zero-crossing detection with high sensitivity. The integrated phase voltage comparator is directly referred to the full BEMF voltage without any attenuation. A BEMF voltage down to 200 mV can be detected, providing high noise immunity and self-commutated operation in a large speed range.
- Real-time motor winding demagnetization detection for fine-tuning the phase voltage masking time to be applied before BEMF monitoring.
- Automatic and programmable delay between BEMF zero-crossing detection and motor phase commutation.
- PWM generation for three-phase sinewave or three-channel independent PWM signals.

1.3 The Brushless DC (BLDC) Motor

A brushless DC (BLDC) motor is a rotating electric machine where the stator is a classic three-phase stator like that of an induction motor and the rotor has surface-mounted permanent magnets. In this respect, the BLDC motor is equivalent to a reversed DC commutator motor, in which the magnet

rotates while the conductors remain stationary. In the DC commutator motor, the current polarity is altered by the commutator and brushes. On the contrary, in the brushless DC motor, the polarity reversal is performed by power transistors switching in synchronization with the rotor position. Therefore, BLDC motors often incorporate either internal or external position sensors to sense the actual rotor position or the position can be detected without sensors.

The BLDC motor is driven by rectangular voltage strokes coupled with the given rotor position. The generated stator flux interacts with the rotor flux, (which is generated by a rotor magnet) and defines the torque and thus speed of the motor. The voltage strokes must be properly applied to the two phases of the three-phase winding system so that the angle between the stator flux and the rotor flux is kept close to 90° to get the maximum generated torque. Due to this fact, the motor requires electronic control for proper operation.

1.4 The AC Induction Motor

The AC induction motor is a rotating electric machine designed to operate from a three-phase source of alternating voltage. The stator is a classic three phase stator with the winding displaced by 120° . The most common type of induction motor has a squirrel cage rotor in which aluminum conductors or bars are shorted together at both ends of the rotor by cast aluminum end rings. When three currents flow through the three symmetrically placed windings, a sinusoidally distributed air gap flux generating the rotor current is produced. The interaction of the sinusoidally distributed air gap flux and induced rotor currents produces a torque on the rotor. The mechanical angular velocity of the rotor is lower than the angular velocity of the flux wave by so called slip velocity.

In adjustable speed applications, AC motors are powered by inverters. The inverter converts DC power to AC power at the required frequency and amplitude. The inverter consists of three half-bridge units where the upper and lower switches are controlled complementarily. As the power device's turn-off time is longer than its turn-on time, some dead-time must be inserted between the turn-off of one transistor of the half-bridge and turn-on of its complementary device. The output voltage is mostly created by a pulse width modulation (PWM) technique. The three-phase voltage waves are shifted 120° to each other and thus a three-phase motor can be supplied.

1.5 Recommended Reading

This documentation describes how to use the AK-ST7FMC Starter Kit and how to set up basic debugging sessions with STMicroelectronics Visual Debug IDE together with the inDART-STX in-circuit debugger/programmer. Additional information can be found in the following documents:

- **ST7FMC Datasheets.**
- **STMicroelectronics Motor Control Application Notes.**
- **AK-ST7FMC Schematic.**
- **Visual Debug Additional Documentation.**
- **inDART-STX for ST7 User's Manual and User's Manual Addendum.**

All of the above documents (and many more) are present on the AK-ST7FMC "System Software" CD-ROM.

Additionally, on the AK-ST7FMC "System Software" CD-ROM, an interactive tutorial on electric motors is present.

1.6 Software Upgrades

The latest version of the AK-ST7FMC system software is always available free of charge from our website: <http://www.softecmicro.com>.

When installing the AK-ST7FMC system software you have the option to electronically register the product. If you register the product, you will be automatically notified by e-mail every time a new version of the AK-ST7FMC system software is available.

1.7 Troubleshooting

A troubleshooting guide is available online at <http://mcu.st.com/faq.html>.

1.8 Getting Technical Support

Technical assistance is provided free to all customers. For technical assistance, documentation and information about products and services, please refer to your local SofTec Microsystems partner.

SofTec Microsystems offers its customers a free technical support service at support@softecmicro.com. Before getting in contact with us, we advise you to check that you are working with the latest version of the AK-ST7FMC system software (upgrades are available free of charge at <http://www.softecmicro.com>).

Additional online support is available on the STMicroelectronics MCU Support Site (<http://mcu.st.com>).

For ST7FMC product information (datasheets, tools, application notes, etc.), please go to <http://mcu.st.com/devicedocs-ST7MC2N6-15.html>.

Knowledge base (FAQ) is available at <http://mcu.st.com/faq.html>.

To subscribe to automatic Motor Control updates please go to <http://mcu.st.com/modules.php?name=Subscription>.

STMicroelectronics also hosts a Motor Control forum at <http://mcu.st.com/forums.html>.

2 AK-ST7FMC Components

2.1 Package Checklist

The AK-ST7FMC package includes the following items:

- The Motor Control board (1).
- A BLDC motor (a 24 V DC AMETEK blower) (2).
- An in-circuit debugger/programmer (inDART-STX) (3).
- An Optoisolation board (code 237-00156) (4).
- An “Alternate Z Sampling” daughter board, to use (optionally) with BLDC motors (code 237-00158) (5).
- Cables: motor cable (6), Optoisolation board’s power supply cable (7), USB Cable (8), ISP Cables (also called ICP cables in STMicroelectronics terminology) (9).
- The SofTec Microsystems AK-ST7FMC “System Software” CD-ROM.
- A “QuickStart Tutorial” color poster.
- The inDART-STX for ST7 user’s manual.
- This user’s manual.

2

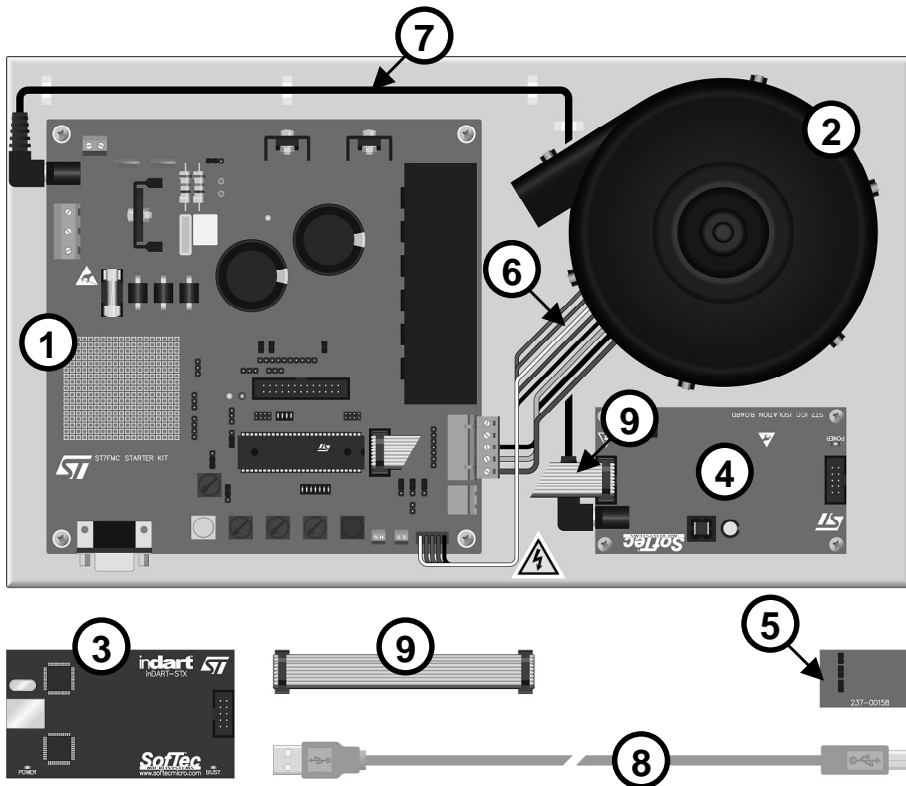

Figure 2.1: AK-ST7FMC Hardware Components

2.2 The Motor Control Board

The following figure illustrates the main connectors and functions of the Motor Control board.

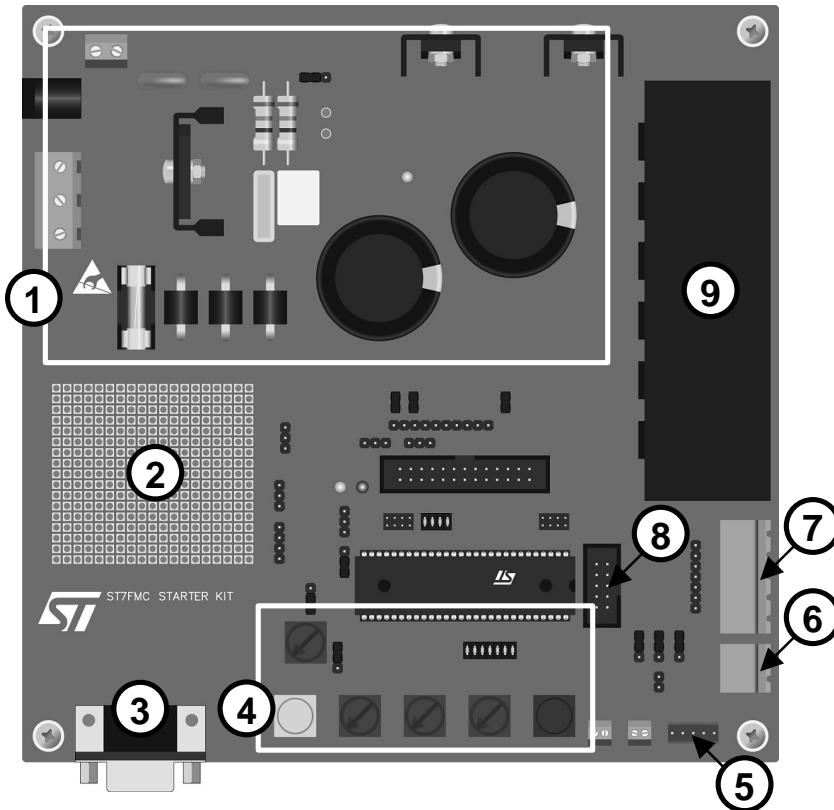

Figure 2.2: Motor Control Board

1. Motor and board input power stage, auxiliary power supply, and voltage rectification.
2. Prototype area.
3. RS-232 connector.
4. Push buttons and trimmers for standalone operation.
5. Hall sensors input.
6. Tachometer input for closed-loop controlled AC motors.
7. Three-phases outputs to motor.
8. ICC connector to isolation board, or directly to inDART-STX.

9. 10 A inverter and level shifter.

2.3 The BLDC Motor

2

The motor included in the AK-ST7FMC Starter Kit is an AMETEK 5" BLDC Low-Voltage (24 V DC) Blower.

For electrical specifications and mechanical dimensions please refer to the AMETEK datasheets present in the SofTec Microsystems AK-ST7FMC "System Software" CD-ROM.

2.4 The In-Circuit Debugger/Programmer (inDART-STX)

inDART-STX is a powerful entry-level tool for STMicroelectronics ST7-based systems. inDART-STX takes advantage of the STMicroelectronics STVD7 (STMicroelectronics Visual Debug) Integrated Development Environment and the ISP (In-System Programming) feature to program the FLASH memory of the microcontrollers belonging to the ST72F family. Together with STVD7, inDART-STX provides you with everything you need to write, compile, download, in-circuit emulate and debug user code. Full-speed program execution allows you to perform hardware and software testing in real time. inDART-STX is connected to the host PC through a USB port, while the 10-pin probe of the product fits into the target's standard ISP connector. A standalone, full-featured programming utility (DataBlaze) is also provided with inDART-STX.

inDART-STX is required to program and in-circuit debug (in real-time) the ST7FMC microcontroller present in the Motor Control board.

For more information on inDART-STX, please refer to the inDART-STX for ST7 User's Manual.

2.5 The Optoisolation board

The Optoisolation board's purpose is to provide galvanic isolation between the inDART-STX in-circuit debugger/programmer board and the Motor Control board. The inDART-STX ISP cable (also called ICP cable in

STMicroelectronics terminology) plugs into the Optoisolation board, while another ISP cable goes from the Optoisolation board to the Motor Control board's ICC connector. The Optoisolation board helps to prevent damage to the PC in the event of a catastrophic failure on the Motor Control board. This isolation barrier also solves the problem caused by the PC, inDART-STX and the Motor Control board being at different ground potentials.

2

2.6 The “Alternate Z Sampling” Daughter Board

When using a BLDC motor the Motor Control board uses, by default, STMicroelectronics patented three-resistor method for BEMF detection. This method has the advantage of being implemented with few components, but has the drawback of limiting the maximum duty cycle of the PWM signal applied to the power switches.

If a specific application requires a 100% PWM duty cycle, the “classical” BEMF detection method must be implemented.

The “Alternate Z Sampling” daughter board allows to drive a BLDC motor using the classical BEMF detection circuit. The daughter board plugs into the J11 connector and into the W14, W15 and W16 jumpers of the Motor Control board.

Of course, motor-specific resistors and capacitors must be mounted on the daughter board.

For detailed information, please refer to STMicroelectronics' AN1946 Application Note.

3 Getting Started for BLDC Motors

3.1 Introduction

The Motor Control board is interfaced to a host PC via the inDART-STX in-circuit debugger/programmer. A control panel application is provided which allows you to change (in real time) all of the motor's electrical parameters. In this way it is possible to learn all of the possibilities offered by the ST7FMC integrated motor control peripheral.



Caution: *before supplying the board, double check proper connections, make sure that there are no metal parts on, below or around the PCB and that there are no undesired earth/ground loops due to measuring equipment such as oscilloscope.*

3

3.2 Step-by-Step Tutorial

3.2.1 Tools Required

For this tutorial, you need:

- The Motor Control board together with the provided BLDC motor;
- The inDART-STX in-circuit debugger/programmer;
- The Optoisolation board;
- A 24 V DC, 4 A power supply (not provided with the Starter Kit).

3.2.2 Installing the Software

Note: *before to connect the inDART-STX board to the PC, it is recommended that you install the AK-ST7FMC Control Panel application first (see below), so that the inDART-STX USB driver will be automatically found by Windows when you connect the board.*

3

To install the AK-ST7FMC Control Panel, insert the SofTec Microsystems “**System Software**” CD-ROM into your computer’s CD-ROM drive. A startup window will automatically appear. Choose “**Install Instrument Software**” from the main menu. A list of available software will appear. Click on the “**AK-ST7FMC Control Panel**” option. Follow the on-screen instructions.

Note: *if you are installing the AK-ST7FMC Control Panel on Windows 2000 or Windows XP you must have logged in as Administrator.*

3.2.3 Installing the Hardware

Connection steps are listed below in the recommended flow order:

1. Verify that all of the Motor Control board jumpers are in their default position (as detailed in Table 5.8: Jumper Settings Example for a BLDC Motor on page 64).
2. The Motor Control board and the provided BLDC motor come assembled together over a metal support. Verify that the motor cable is correctly connected between the Motor Control board’s “MOTOR” connector (J12) and the motor terminal connector.
3. The Motor Control board and the Optoisolation board come already connected through an ISP cable. Moreover, the Optoisolation board’s power connector is also already connected to the Motor Control board’s J2 connector. In this way, the Motor Control board automatically supplies the Optoisolation board. Verify that both the power cable and the ISP cable are connected as stated above.

4. Connect inDART-STX to the Optoisolation board with the other ISP cable provided (from inDART-STX's "ISP" connector to the Optoisolation board's "ICC IN" connector).
5. Connect inDART-STX to the host PC with the USB cable provided. The green "POWER" LED on the instrument will turn on. Windows will automatically recognize the instrument and will load the appropriate USB driver.
6. Power up the Motor Control board by connecting the output terminals of your DC power supply to the "MAINS" connector. The provided voltage must be 24 V DC and your power supply must be able to provide a current of 4 A.

3

Note: *both Windows 2000 and Windows XP may issue a warning the first time inDART-STX is connected to the PC. This warning is related to the fact that the USB driver used by inDART-STX is not digitally signed by Microsoft, and Windows considers it to be potentially malfunctioning or dangerous for the system. However, you can safely ignore the warning, since every kind of compatibility/security test has been carried out by SofTec Microsystems.*

3.2.4 Tutorial Steps

1. Start the AK-ST7FMC Control Panel by selecting **Start > Programs > SofTec Microsystems > AK-ST7FMC > AK-ST7FMC Control Panel**. The AK-ST7FMC Control Panel application will open.
2. You will be asked what motor type you are working with. Select the "**3 Phase Brushless Permanent Magnet AC or DC Motor (Trapezoidal)**" option and click the "**OK**" button.

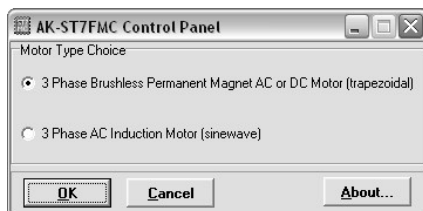

Figure 3.1: Motor Type Choice Dialog Box

Getting Started for BLDC Motors

3. A dialog box will appear asking you to check for proper jumpers configuration. Click the “OK” button.
4. The AK-ST7FMC Control Panel main window will open.

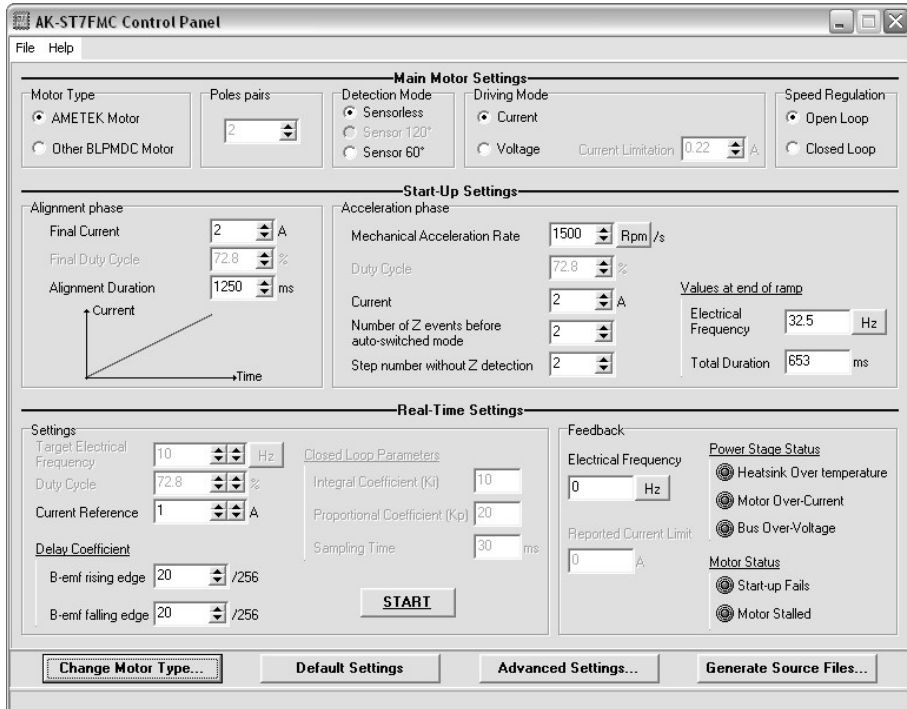

Figure 3.2: AK-ST7FMC Control Panel Main Window for BLDC Motors

5. Change the “**Speed Regulation**” parameter to “**Closed Loop**” and click the “**START**” button. A firmware will be automatically created based on all of the AK-ST7FMC Control Panel’s parameter and downloaded to the ST7FMC microcontroller in the Motor Control board. At the end of the download phase the motor will start to run.
6. Change the “**Target Mechanical Speed**” parameter to **5000** by typing in the new value and pressing the Enter key. The new parameter will be downloaded to the ST7FMC microcontroller in real time and the motor will accelerate.
7. Click the “**STOP**” button to stop the motor.

Congratulations! You have successfully completed this tutorial! You can now continue to experiment with the AK-ST7FMC Control Panel on your own.

Additionally, you can develop and debug your own application by installing the “inDART-STX for ST7” software (which includes a complete development toolchain) present on the SofTec Microsystems “System Software” CD-ROM.

4 Getting Started for AC Motors

4.1 Introduction

The Motor Control board is interfaced to a host PC via the inDART-STX in-circuit debugger/programmer. A control panel application is provided which allows you to change (in real time) all of the motor's electrical parameters. In this way it is possible to learn all of the possibilities offered by the ST7FMC integrated motor control peripheral.



Caution: *before supplying the board, double check proper connections, make sure that there are no metal parts on, below or around the PCB and that there are no undesired earth/ground loops due to measuring equipment such as oscilloscope.*

4

Caution: *when the Motor Control board is supplied with voltages greater than 30 V AC/DC, all of the board and components must be considered "hot", and any contact with the board must be avoided. The operator should stay away from the board as well (risk of projection of material in case of components destruction, especially when powering the board with high voltages). The rotating parts of motors are also a source of danger.*

4.2 Step-by-Step Tutorial

4.2.1 Tools Required

For this tutorial, you need:

- The Motor Control board;
- The three-phase, SELNI AC motor (available as an accessory—SofTec Microsystems order code 237-00157);
- The inDART-STX in-circuit debugger/programmer;
- The Optoisolation board.

4.2.2 Installing the Software

Note: *before to connect the inDART-STX board to the PC, it is recommended that you install the AK-ST7FMC Control Panel application (see below), so that the inDART-STX USB driver will be automatically found by Windows when you connect the board.*

4

To install the AK-ST7FMC Control Panel, insert the SofTec Microsystems “**System Software**” CD-ROM into your computer’s CD-ROM drive. A startup window will automatically appear. Choose “**Install Instrument Software**” from the main menu. A list of available software will appear. Click on the “**AK-ST7FMC Control Panel**” option. Follow the on-screen instructions.

Note: *if you are installing the AK-ST7FMC Control Panel on Windows 2000 or Windows XP you must have logged in as Administrator.*

4.2.3 Installing the Hardware

Connection steps are listed below in the recommended flow order:

1. Verify that all of the Motor Control board jumpers are set up to use with an AC motor (as explained in Table 5.9: Jumper Settings Example for an AC Motor on page 65).
2. The Motor Control board and the provided BLDC motor come assembled together over a metal support. To use the AC motor you

must first disconnect the BLDC motor cable from the “MOTOR” connector (J12) and from the “HALL SENSOR” connector (J19).

3. Connect the AC motor phases to the Motor Control board’s “MOTOR” connector (J12) with the motor cable provided with the AC motor.
4. Connect the AC motor tachometer sensor to the Motor Control board’s “TACHOMETER” connector (J16) with the tachometer cable provided with the AC motor.
5. The Motor Control board and the Optoisolation board come already connected through an ISP cable. Moreover, the Optoisolation board’s power connector is also already connected to the Motor Control board’s J2 connector. In this way, the Motor Control board automatically supplies the Optoisolation board. Verify that both the power cable and the ISP cable are connected as stated above.
6. Connect inDART-STX to the Optoisolation board with the other ISP cable provided (from inDART-STX’s “ISP” connector to the Optoisolation board’s “ICC IN” connector).
7. Connect inDART-STX to the host PC with the USB cable provided. The green “POWER” LED on the instrument will turn on. Windows will automatically recognize the instrument and will load the appropriate USB driver.
8. Make sure that the “S1” jumper selects the “<35V ONLY” position, then power up the Motor Control board by connecting the output terminals of your DC power supply to the “MAINS” connector. The provided voltage must be 30 V DC and your power supply must be able to provide a current of 4 A.

Note: *both Windows 2000 and Windows XP may issue a warning the first time inDART-STX is connected to the PC. This warning is related to the fact that the USB driver used by inDART-STX is not digitally signed by Microsoft, and Windows considers it to be potentially malfunctioning or dangerous for the system. However, you can safely ignore the warning, since every kind of compatibility/security test has been carried out by SofTec Microsystems.*

4.2.4 Tutorial Steps

1. Start the AK-ST7FMC Control Panel by selecting **Start > Programs > SofTec Microsystems > AK-ST7FMC > AK-ST7FMC Control Panel**. The AK-ST7FMC Control Panel application will open.
2. You will be asked what motor type you are working with. Select the “**3 Phase AC Induction Motor (Sinewave)**” option and click the “**OK**” button.
3. A dialog box will appear asking you to check for proper jumpers configuration. Click the “**OK**” button.
4. The AK-ST7FMC Control Panel main window will open.

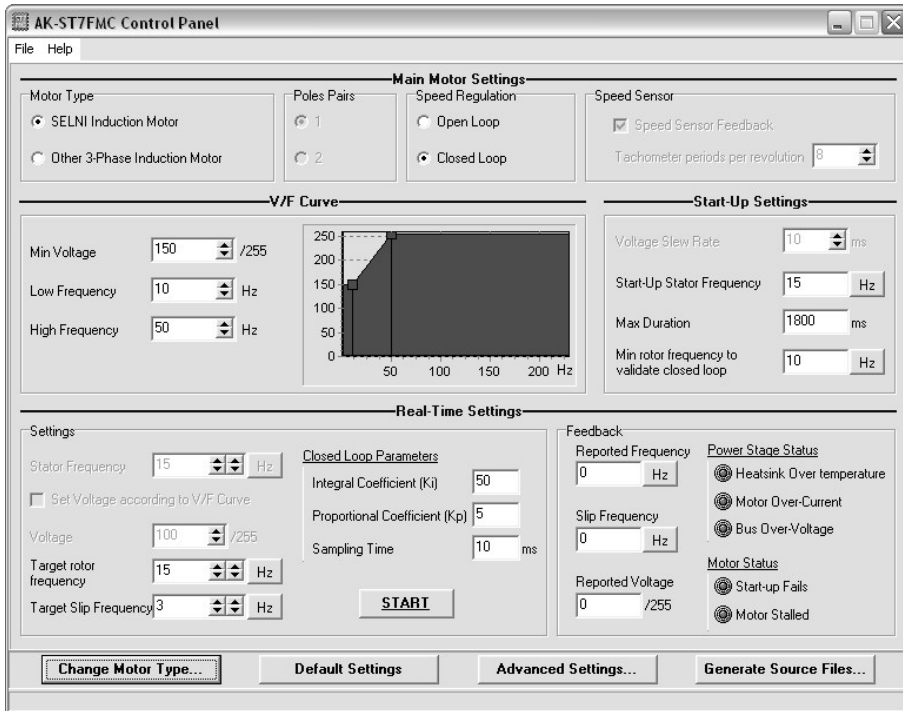

Figure 4.1: AK-ST7FMC Control Panel Main Window for AC Motors

5. Click the **“START”** button. A firmware will be automatically created based on all of the AK-ST7FMC Control Panel’s parameter and downloaded to the ST7FMC microcontroller in the Motor Control board. At the end of the download phase the motor will start to run.
6. Change the **“Target Rotor Frequency”** parameter to **40** by typing in the new value and pressing the Enter key. The new parameter will be downloaded to the ST7FMC microcontroller in real time and the motor will accelerate.
7. Click the **“STOP”** button to stop the motor.

Congratulations! You have successfully completed this tutorial! You can now continue to experiment with the AK-ST7FMC Control Panel on your own.

Additionally, you can develop and debug your own application by installing the “inDART-STX for ST7” software (which includes a complete development toolchain) present on the SofTec Microsystems “System Software” CD-ROM.

5 Connectors and Functions

5.1 Power Supply

5.1.1 Introduction

The Motor Control board can be supplied in two ways:

- **Single power supply (for motors requiring a voltage greater than 18 V).**

Power is supplied to the J3 connector. Power supply voltage must not be higher than 42 V DC or 30 V_{eff} AC. This power supplies both the motor and the Motor Control board. A 15 V DC voltage is automatically generated for the Motor Control board logic. However, depending on the voltage supplied to the J3 connector, two cases are possible:

1. If the supplied voltage is greater than 35 V DC, the S1 jumper must select the “HIGH VOLTAGE” position;
2. If the supplied voltage is between 18 V and 35 V DC, the S1 jumper must select the “<35V ONLY” position.

- **Dual power supply (for motors requiring a voltage less than 18 V).**

Power for the motor is supplied to the J3 connector, while a separate power for the Motor Control board logic must be supplied to the J1 connector (15 V DC, 0.5 A). **The S1 jumper must be removed.**

Note: *on the J3 connector, polarity of DC or AC input is not important.*

5.1.2 Optoisolation Board Supply

The Optoisolation board requires a 15 V DC power supply. This power is conveniently provided by the Motor Control board's J2 connector.

Note: *J1 and J2 connectors are internally connected to the same 15 V DC power bus.*

5.1.3 Power Supply Connectors Summary

The following figure illustrates the location of the Motor Control board power supply connectors.

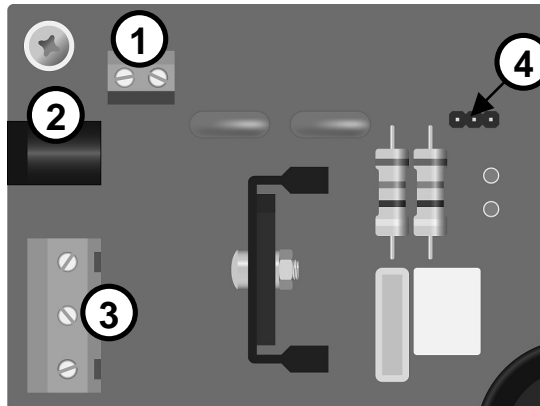

Figure 5.1: Power Supply Connectors

1. J1 connector. 15 V DC, 0.5 A power supply input (used for dual power supply mode).
2. J2 connector. 15 V DC output to Optoisolation board.
3. J3 connector. Motor power supply (for dual power supply mode) or motor plus Motor Control board power supply (for single power supply mode). Up to 42 V DC or 30 Veff AC.

4. S1 jumper. In single power supply mode, selects the motor voltage. In dual power supply mode, it must be removed.

5.2 Push-Buttons and Potentiometer (Standalone Mode)

5.2.1 Introduction

Four potentiometer and two push-buttons are available on the Motor Control board for standalone operation (no PC connection required). To operate the Motor Control board in standalone mode, several steps must be completed to ensure compatibility between the ST7FMC firmware and the push-buttons and potentiometers.

5.2.2 Preparing for Standalone Mode: General Notes

The steps below must be followed to generate the correct firmware to use the Motor Control board in standalone mode. Please note that the firmware is motor-specific. After generating (and downloading to the ST7FMC microcontroller) the appropriate firmware for the type of motor and the type of control you want to use, the push-buttons and potentiometers are available for use in standalone mode, as explained later.

5

Note: *the following steps require that the inDART-STX for ST7 System Software be installed.*

*To install the inDART-STX for ST7 System Software, insert the SofTec Microsystems “**System Software**” CD-ROM into your computer’s CD-ROM drive. A startup window will automatically appear. Choose “**Install Instrument Software**” from the main menu. A list of available software will appear. Click on the “**inDART-STX for ST7**” option. Follow the on-screen instructions.*

Note: *in order to compile a project linked to the STMicroelectronics Motor Control library, you must have a full version of either the Metrowerks or Cosmic C compiler. Due to the size of the STMicroelectronics Motor Control library, and the code size limit of the evaluation versions of these compilers, any attempt to compile a project linked to the Motor Control library will not succeed, unless you have the full version of the above compilers.*

Note: *the following steps illustrate how to use the Metrowerks C compiler to compile a project based on the STMicroelectronics Motor Control library. Similar procedures apply for the Cosmic C compiler.*

5

5.2.3 Preparing for Standalone Mode: BLDC Motors

1. Set up the Motor Control board as explained in the “Installing the Hardware” section in the “Getting Started for BLDC Motors” chapter.
2. Get the latest release of the AK-ST7FMC Control Panel system software from SofTec Microsystems website (<http://www.softecmicro.com>), uninstall the previous version and install the new one.
3. In the “**\Program Files\SofTec Microsystems\AK-ST7FMC\Library**” directory there are various subdirectories, each specific for a motor/control type (e.g. “BLDC Sensorless”). Each subdirectory contains a pre-made project specific for that motor/control type. Copy the appropriate subdirectory (the subdirectory that corresponds to your motor and control type) into another location. The copied subdirectory will become your working directory.
4. Run the AK-ST7FMC Control Panel by selecting **Start > Programs > SofTec Microsystems > AK-ST7FMC > AK-ST7FMC Control Panel**.
5. You will be asked what motor type you are working with. Select the “**3 Phase Brushless Permanent Magnet AC or DC Motor (Trapezoidal)**” option and click the “**OK**” button. The main AK-ST7FMC Control Panel window will open.
6. To run a BLDC motor in standalone mode (Closed Loop), you must choose an optimum sampling time and collect, for each of four critical

speeds, a set of real-time parameters (rising BEMF delay, falling BEMF delay, Ki and Kp). These parameters must be fine tuned for the minimum and maximum motor speed (the same speeds specified in the **Advanced Settings** window) plus two other intermediate speeds of your choice. During operation, the ST7FMC firmware will make a linear extrapolation of real-time parameters in between the four specified speeds to ensure smooth operation (for more information about parameter collecting, refer to the STMicroelectronics' Application Note AN1905).

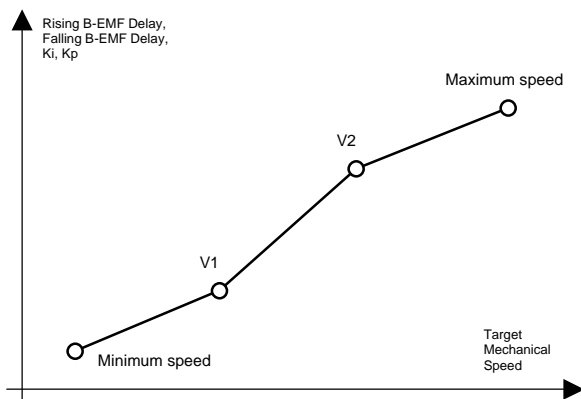

Figure 5.2: BLDC Motor Closed Loop Parameters Collecting

5

7. To run a BLDC motor in standalone mode (Open Loop), it is not necessary to collect any real-time settings, since all real-time parameters are controlled through the potentiometers.
8. Click the **“Generate Source Files...”** button. Browse for your working directory and select the **“\source”** subdirectory. Click the **“OK”** button. The appropriate header files will be generated and saved in the **“\source”** subdirectory as *.h files. All parameters set in the AK-ST7FMC Control Panel (other than the real-time parameters listed in point 6) are saved automatically in the *.h files.
9. Run the STVD7 IDE by selecting **Start > Programs > SofTec Microsystems > inDART-STX > ST7 > STVD7 for inDART-STX**.
10. From the main menu, choose **File > Open Workspace**. Select the **“BLDC_Sensorless_Metrowerks.wsp”** or **“BLDC**

_Sensor_Metrowerks.wsp” workspace file that is located under your working directory. Click **“Open”**.

11. Only in the case of Closed Loop control, some defines in the **“mtc.h”** file must be edited according to the collected parameters. The defines to be edited are listed in the following table.

Table 5.1: BLDC Motor Closed Loop Standalone Firmware Defines

BLDC Motor-Specific Defines to Be Edited
#define SAMPLING_TIME
#define Rising_Fmin
#define Falling_Fmin
#define Ki_Fmin
#define Kp_Fmin
#define F_1
#define Rising_F_1
#define Falling_F_1
#define Ki_F_1
#define Kp_F_1
#define F_2
#define Rising_F_2
#define Falling_F_2
#define Ki_F_2
#define Kp_F_2
#define Rising_Fmax
#define Falling_Fmax
#define Ki_Fmax
#define Kp_Fmax

12. Select the **“Build”** command from the **“Project”** menu. The project will be compiled and built, and an executable file will be generated.

13. Using the DataBlaze programming utility, you can now program the ST7FMC microcontroller with the generated executable. To launch DataBlaze, select **Start > Programs > SofTec Microsystems > inDART-STX > ST7 > DataBlaze Programmer**.
14. From the DataBlaze's main menu, select **Operations > Select Device**. Make sure that the "**Programming Hardware**" parameter is set to "**inDART-STX**" and that the "**Device Code**" parameter specifies the "**ST7FMC2N6B**" microcontroller. Click the "**OK**" button.
15. From the DataBlaze's main menu, select **File > Load > Code Buffer**. Change the "**Format**" parameter to "**Motorola S-Rec**" and browse for the **BLDC_Metrowerks.s19** file located under the "**object\Metrowerks**" subdirectory in your working directory. Click the "**OK**" button.
16. From the DataBlaze's main menu, select **Edit > Option Bytes**. The Option Bytes must be edited as detailed in the table below.

Table 5.2: Option Bytes Settings for ST7FMC Programming

Option Bits	Setting
[FMP_R] - Read-Out Protection	Read-Out Protection Disabled
[DIV2] - Divider by 2	DIV2 divider enabled
[RSTC] - RESET Clock Cycle Selection	Reset phase with 4096 CPU cycles
[VD] - Voltage Detection Selection	LVD and AVD On
[CKSEL] - Clock Source Selection	PLL clock selected
[WDG_SW] - Watchdog Activation	Software
[WDG_HALT] - Watchdog and Halt Mode	Reset in HALT
[MCO] - Motor Control Output Options	Low
[PKG] - Package Selection	SDIP56

17. From the DataBlaze's main menu, select **Operations > Auto**. Make sure that all of the programming steps (but "**Run**") are enabled. Click the "**START**" button.
18. Now the microcontroller is programmed. You can unplug the ISP cable from the Motor Control board and operate the Motor Control board in standalone mode.
19. To start running the microcontroller, press the "RESET" push-button. For details about how to control the motor with the Motor Control

board's push-buttons and potentiometers, please refer to the "Push-Buttons", "Potentiometers" and "Standalone Mode: Driving a BLDC Motor" sections later in this chapter.

5.2.4 Preparing for Standalone Mode: AC Motors

1. Set up the Motor Control board as explained in the "Installing the Hardware" section in the "Getting Started for AC Motors" chapter.
2. Get the latest release of the AK-ST7FMC Control Panel system software from SofTec Microsystems website (<http://www.softecmicro.com>), uninstall the previous version and install the new one.
3. In the "**Program Files\SofTec Microsystems\AK-ST7FMC\Library**" directory there are various subdirectories, each specific for a motor/control type. Each subdirectory contains a pre-made project specific for that motor/control type. Copy the appropriate subdirectory (the subdirectory that corresponds to your motor and control type) into another location. The copied subdirectory will become your working directory.
4. Run the AK-ST7FMC Control Panel by selecting **Start > Programs > SofTec Microsystems > AK-ST7FMC > AK-ST7FMC Control Panel**.
5. You will be asked what motor type you are working with. Select the "**3 Phase AC Induction Motor (Sinewave)**" option and click the "**OK**" button. The main AK-ST7FMC Control Panel window will open.
6. To run an AC motor in standalone mode (Closed Loop), you must choose an optimum sampling time and then characterize two curves, a K_i , K_p versus stator frequency curve and a slip frequency versus stator frequency curve. Both curves must have two points, as illustrated below.

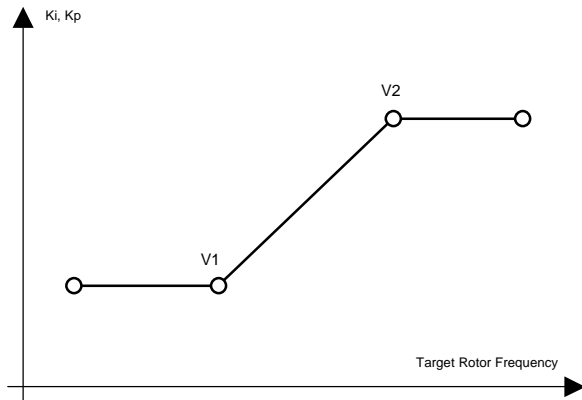

Figure 5.3: AC Motor Closed Loop Parameters Collecting: Ki, Kp

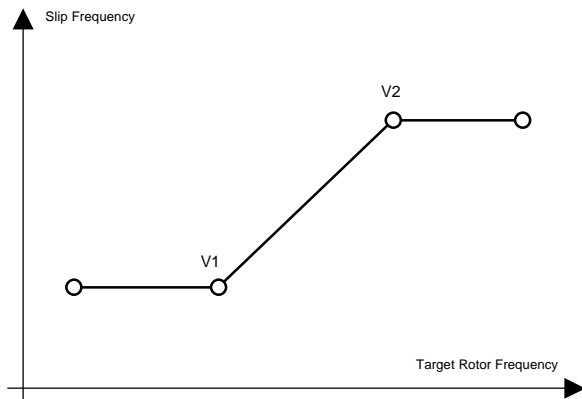

Figure 5.4: AC Motor Closed Loop Parameters Collecting: Slip Frequency

5

7. To run an AC motor in standalone mode (Open Loop), it is not necessary to collect any real-time settings, since all real-time parameters are controlled through the potentiometers.
8. Click the **“Generate Source Files...”** button. Browse for your working directory and select the **“\source”** subdirectory. Click the **“OK”** button. The appropriate header files will be generated.
9. Run the STVD7 IDE by selecting **Start > Programs > SofTec Microsystems > inDART-STX > ST7 > STVD7 for inDART-STX**.

10. From the main menu, choose **File > Open Workspace**. Select the “**AC_Metrowerks.wsp**” workspace file that is located under your working directory. Click “**Open**”.
11. Only in the case of Closed Loop control, some defines in the “**ACMPParam.h**” file must be edited according to the collected parameters. The defines to be edited are listed in the following table.

Table 5.3: AC Motor Closed Loop Standalone Firmware Defines

AC Motor-Specific Defines to Be Edited
#define SAMPLING_TIME
#define PI_PROP_LOWSPD
#define PI_PROP_HIGHSPEED
#define PI_INT_LOWSPD
#define PI_INT_HIGHSPEED
#define PI_LOWFREQ_LIMIT
#define PI_HIGHFREQ_LIMIT
#define OPT_SLIP_LOWFREQ_LIMIT
#define OPT_SLIP_HIGHFREQ_LIMIT
#define OPT_SLIP_LOWFREQ
#define OPT_SLIP_HIGHFREQ

5

12. Select the “**Build**” command from the “**Project**” menu. The project will be compiled and built, and an executable file will be generated.
13. Using the DataBlaze programming utility, you can now program the ST7FMC microcontroller with the generated executable. To launch DataBlaze, select **Start > Programs > SofTec Microsystems > inDART-STX > ST7 > DataBlaze Programmer**.
14. From the DataBlaze’s main menu, select **Operations > Select Device**. Make sure that the “**Programming Hardware**” parameter is set to “**inDART-STX**” and that the “**Device Code**” parameter specifies the “**ST7FMC2N6B**” microcontroller. Click the “**OK**” button.
15. From the DataBlaze’s main menu, select **File > Load > Code Buffer**. Change the “**Format**” parameter to “**Motorola S-Rec**” and browse for

the **AC_Metrowerks.s19** file located under the “**object\Metrowerks**” subdirectory in your working directory. Click the “**OK**” button.

16. From the DataBlaze's main menu, select **Edit > Option Bytes**. The Option Bytes must be edited as detailed in Table 5.2: Option Bytes Settings for ST7FMC ProgrammingTable 5.2: Option Bytes Settings for ST7FMC Programming on page 45.
17. From the DataBlaze's main menu, select **Operations > Auto**. Make sure that all of the programming steps (but “**Run**”) are enabled. Click the “**START**” button.
18. Now the microcontroller is programmed. You can unplug the ISP cable from the Motor Control board and use the Motor Control board in standalone mode.
19. To start running the microcontroller, press the “**RESET**” push-button. For details about how to control the motor with the Motor Control board's push-buttons and potentiometers, please refer to the “**Push-Buttons**”, “**Potentiometers**” and “**Standalone Mode: Driving an AC Motor**” sections here below.

5

5.2.5 Push-Buttons

The following figure shows the location of the two push-buttons available in the Motor Control board.

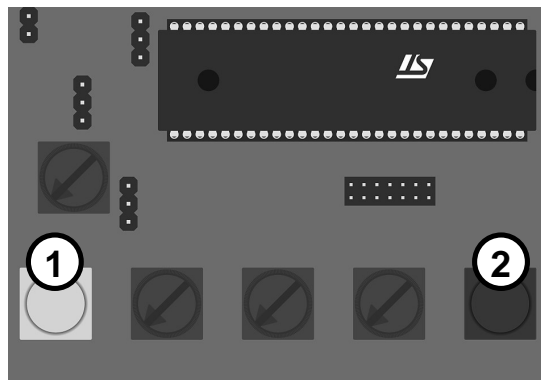

Figure 5.5: Push Buttons

1. “ON/OFF”: starts or stops the motor.
2. “RESET”: resets the ST7FMC microcontroller.

5.2.6 Potentiometers

The following figure shows the location of the four potentiometers available in the Motor Control board.

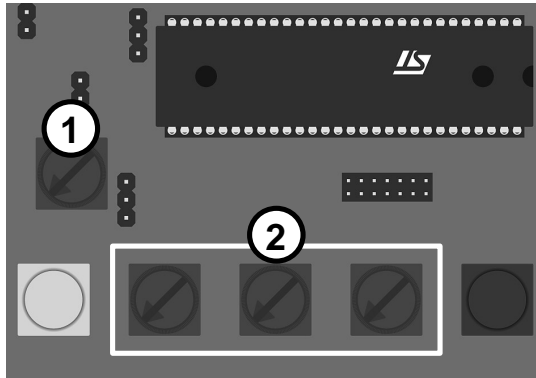

Figure 5.6: Potentiometers

1. “POT1”: current reference setting (for BLDC motor only).
2. “RV1”, “RV2”, “RV3”: open loop and closed loop settings.

5.2.7 Standalone Mode: Driving a BLDC Motor

A BLDC motor can be driven in Current mode or Voltage mode. Depending on the driving mode, you must set the W12 jumper accordingly. Furthermore, in either mode, you can drive the motor in Open Loop mode or Closed Loop mode.

The W12 jumper must be set as follows.

- If the W12 jumper selects the “VARIABLE” position, the current reference comes from a PWM-generated, RC-filtered signal generated by the ST7FMC microcontroller. The “VARIABLE” position may be selected either in Current mode or Voltage mode. Note: In Voltage

mode, the maximum current is set in the AK-ST7FMC Control Panel before generating the .h files.

- If the W12 jumper select the “FIXED” position, the current reference comes from the “POT1” potentiometer. **The “FIXED” position can be selected only in Voltage mode.**

The following table summarizes how the potentiometers can be used in Open Loop mode or Closed Loop mode for a BLDC motor.

Table 5.4: Open and Closed Loop Standalone Controls for a BLDC Motor

Potentiometer	Open Loop	Closed Loop
RV1	Sets the duty cycle (Voltage mode) or the current reference (Current mode)	Sets the target speed (frequency)
RV2	Sets the coefficient to calculate the delay for a rising BEMF	Not used
RV3	Sets the coefficient to calculate the delay for a falling BEMF	Not used
POT1	Sets the maximum current allowed in the motor (Voltage mode only)	Sets the maximum current allowed in the motor (Voltage mode only)

Note: *in Current mode, the W12 jumper must always select the “VARIABLE” position to allow dynamic current control by the ST7FMC microcontroller. In Current mode, the “POT1” potentiometer is inactive.*

5.2.8 Standalone Mode: Driving an AC Motor

The following table summarizes how the potentiometers can be used in Open Loop mode or Closed Loop mode for an AC motor.

Table 5.5: Open and Closed Loop Standalone Controls for an AC Motor

Potentiometer	Open Loop	Closed Loop	Closed Loop with PI Tuning
RV1	Sets the stator frequency (from 1 Hz to 256 Hz)	Set the target speed (from 10 Hz to 266 Hz)	Set the target speed (from 10 Hz to 266 Hz)
RV2	Sets the stator voltage (from 0 V to the limit set by the V/F curve)	Not used	Sets the Ki integral coefficient (from 0 to 255)
RV3	Sets the braking torque (from a 0 to 40% PWM duty cycle if the PWM frequency is 12.5 KHz and from 0 to 50% for other PWM frequencies)	Not used	Sets the Kp proportional coefficient (from 0 to 255)
POT1	Not used	Not used	Not used

5

5.3 BLDC Motor Outputs and Feedback

5.3.1 Introduction

The Motor Control board can be configured to drive a BLDC motor in Sensor/Sensorless mode, Open/Closed Loop mode, and an AC motor in Open/Closed loop. This sections explains how to configure the Motor Control board to drive a BLDC motor, while the next section explains how to configure the Motor Control board to drive an AC motor. The following figure illustrates where the input (sensor) connectors, the output connector (motor phases) and related jumper settings selectors are located.

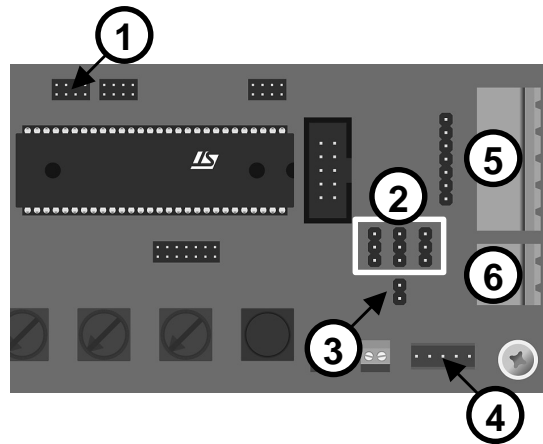

Figure 5.7: Motor Outputs and Feedback

1. J8: filtering capacitors jumper selection.
2. W14, W15, W16: Sensor/Sensorless mode jumper selection.
3. W13: tachometer jumper selection (AC motors only).
4. J19: Hall sensors input connector.
5. J12: motor phases output connector.
6. J16: tachometer input connector.

5

A BLDC motor can be controlled in Sensorless mode (using STMicroelectronics patented three-resistor method), in Sensorless mode (using classic method) and in Sensor mode, as detailed below.

5.3.2 Sensorless Mode (STMicroelectronics Method)

To drive a BLDC motor in Sensorless mode, using STMicroelectronics patented three-resistor method, the W14, W15 and W16 jumpers should select the upper position (default factory setting). The W13 jumper and all of the J8 jumpers should be removed.

Additionally, the **“Z Event Sampling Method”** parameter, in the AK-ST7FMC Control Panel (in the *Advanced Settings* dialog box) should be set to **“At the end of the PWM low state”**.

5.3.3 Sensorless Mode (Standard Method)

To drive a BLDC motor in Sensorless mode using classic method (dividers and filters on each of the three phases and reconstruction of the motor virtual neutral), the “Alternate Z Sampling” daughter board supplied with the kit should be plugged in on the pins of the W14, W15 and W16 jumpers and on the pins of the J11 connector. The W13 jumper must be removed. The J8 jumpers can be kept if the provided 2.2 nF filtering capacitors are compatible with the filter needed.

Of course, motor-specific resistors and capacitors must be mounted on the daughter board (see STMicroelectronics application note AN1946)

Additionally, the “**Z Event Sampling Method**” parameter, in the AK-ST7FMC Control Panel (in the *Advanced Settings* dialog box) should be set to “**At PWM on, with delay, once**”, to “**At PWM on, with delay, at f_{SCF} frequency**” or to “**At f_{SCF} frequency**”.

5

5.3.4 Sensor Mode

To drive a BLDC motor in Sensor mode, the W14, W15 and W16 jumpers should select the lower position. The W13 jumper must be removed. The J8 jumpers can be kept to filter the sensor signal.

5.4 AC Motor Outputs and Feedback

An AC motor can be controlled in open or closed loop, as detailed below.

5.4.1 Open Loop

To drive an AC motor in open loop, the W14 and W15 jumpers must select the lower position, the W16 jumper must be removed, and all of the J8 jumpers must be present.

5.4.2 Closed Loop

To drive an AC motor in closed loop, the W14 and W15 jumpers must select the lower position, and the W16 jumper must be removed. Additionally, the W13 jumper must be present, to feed the tachometer signal to the

microcontroller's MCIC input. This signals needs to be filtered by the C56 capacitor. The filtering is done by placing a jumper between pins 7 and 8 in the J8 connector.

5.5 ICC Connector

The ST7FMC microcontroller can be in-circuit programmed via the "ICC" connector, using the inDART-STX in-circuit debugger/programmer.

5.6 External Power Stage Connectors

Two connectors allow you to override the internal power inverter.

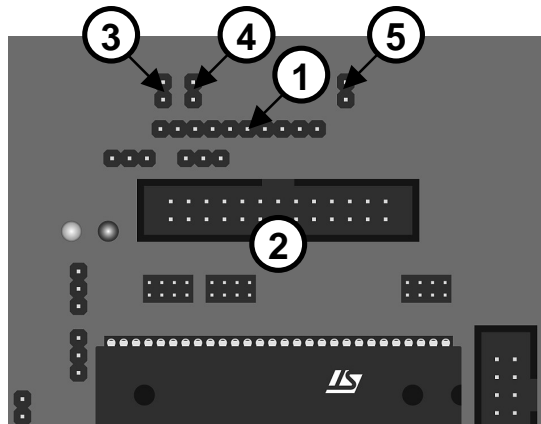

Figure 5.8: Motor Outputs and Feedback

1. J4: AC motor power connector.
2. J6: BLDC motor power connector.
3. W3: onboard power inverter current sensor.
4. W4: onboard power inverter diagnostic/enable.
5. W5: onboard power inverter thermal sensor.

The W3 and W4 jumpers should be removed when using an external power inverter. The W5 jumper should be present if no thermal monitoring is available on the external power inverter, otherwise the thermal sensor must be connected to pin 1 of the W5 jumper.

5.7 RS-232 Connector

An optoisolated RS-232 connector allows the Motor Control board to be connected to a PC for displaying information about using a terminal utility like HyperTerminal. By default, AC motor real-time values such as speed, voltage, stator frequency, etc. are sent to the PC (see STMicroelectronics Application Note AN1904).

5.8 Summary of Jumper and Connector Settings

5.8.1 Jumpers Summary

Table 5.6: Jumpers Summary

Name	Selection	Description
S1	"HIGH VOLTAGE"	Motor supply is greater than 35 V DC or 25 Veff AC.
	"<35V ONLY"	Motor supply is less than 35 V DC or 25 Veff AC.
	Not present	Motor supply is separated from Motor Control board. The Motor Control board must be supplied with 15 V DC (0.5 A) on J1.
W3	Present	Connects the R21 shunt resistor to external Operational OpAmp circuitry and to the ST7FMC internal OpAmp.
	Not present	Disconnects the R21 shunt resistor from the external Operational OpAmp circuitry and to the ST7FMC internal OpAmp, when using an external power stage through J4 or J6.
W4	Present	Connects the diagnostic output of the L6386 driver to the MCEs pin of the ST7FMC and enables the onboard inverter power stage.
	Not present	Disables the onboard inverter, when using an external inverter power stage on J4 or J6.
W5	Present	Connects the heatsink thermal sensor (NTC2, located on the bottom side of the PCB) to the AIN0 pin of the ST7FMC.
	Not present	Heatsink thermal sensor not connected to the AIN0 pin of the ST7FMC.
W6	Not present	ST7FMC internal OpAmp is used to amplify current sensed by the R21 shunt resistor.
	Upper position	ST7FMC internal OpAmp not used. External OpAmp not used. The ST7FMC MCCF10 pin (comparator input) is directly connected to the R21 shunt resistor to sense current.
	Lower position	ST7FMC internal OpAmp not used. External OpAmp used to amplify the current sensed by the R21 shunt resistor. The ST7FMC MCCF10 pin (comparator input) is connected to the external OpAmp output.
W7	"15V" (left position)	A voltage of 15 V DC is applied on pin 9 of J4 (to supply the external inverter and driver).

5





Name	Selection	Description
	"5V" (right position)	A voltage of 5 V DC is applied on pin 9 of J4 (to supply the external inverter and driver).
W8	"5V" (left position)	A voltage of 5 V DC is applied on pin 8 of J4.
	Right position	The pin 8 of J4 is redirected to the MCES input of the ST7FMC.
W9	"INT" (lower position)	Internal voltage is applied to the WUP pin of the L9638 LIN transceiver. LIN transceiver supplied with the onboard 15 V DC, mainly for debugging purposes.
	"EXT" (upper position)	External voltage is applied to the WUP pin of the L9638 LIN transceiver. LIN transceiver supplied with external voltage, typically the battery bus in automotive applications.
W10	Upper position	The TDO output of the ST7FMC is directed to the L9638 LIN transceiver.
	Lower position	The TDO output of the ST7FMC is directed to ST232 UART transceiver.
W11	Upper position	The RDI input of the ST7FMC comes from the L9638 LIN transceiver.
	Lower position	The RDI input of the ST7FMC comes from the ST232 UART transceiver.
W12	"VARIABLE"	The current reference comes from a PWM-generated, RC-filtered signal generated by the ST7FMC microcontroller (Current mode or Voltage mode).
	"FIXED"	The current reference comes from the "POT1" potentiometer (Voltage mode only).
W13	Not present	BLDC motor: sensorless input on the MCIA, MCIB, MCIC pins of the ST7FMC (rotor position information comes from motor's three phases).
W14	Upper position	
W15	Upper position	
W16	Upper position	
W13	Not present	BLDC motor: sensor input on the MCIA, MCIB, MCIC pins of the ST7FMC (rotor position information comes from J19).
W14	Lower position	
W15	Lower position	
W16	Lower position	
W13	Not present	AC motor with no tachometer sensor.
W14	Lower position	
W15	Lower position	
W16	Lower position	

Name	Selection	Description
W13	Present	AC motor with tachometer sensor (the tachometer signal is connected to the MCIC input of the ST7FMC).
W14	Lower position	
W15	Lower position	
W16	No Jumper	
J8	All jumpers present	AC motor: tachometer signal is filtered with capacitors. BLDC motor, sensorless method other than STMicroelectronics method: the four analog inputs MCIA, MCIB, MCIC and MCVREF are filtered with capacitors. BLDC motor, Sensor mode: hall sensors signals are filtered with capacitors.
	No jumper present	BLDC motor, STMicroelectronics sensorless method.
J9	All jumpers present	Connects the bus voltage to the AIN1 pin of the microcontroller, and the temperature monitoring signal to the AIN0 pin of the microcontroller.
	No jumper present	No monitoring of bus voltage or temperature (not recommended). The AK-ST7FMC Control Panel and the Motor Control library might not work properly if these jumpers are removed (real-time monitoring of bus voltage and heatsink temperature might read values leading to motor stop).
J10	All jumpers present	May be used for wrapping purposes on ST7FMC Port E[3:0] I/O pins.
J15	All jumpers present	Always connected.

5.8.2 Connectors Summary/Pinout



The following table details the pinout of each of the Motor Control board's connector.



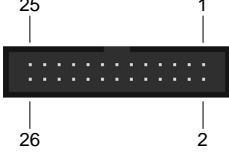

Table 5.7: Connectors Summary/Pinout

Name	Reference	Description/Pinout
J1		<p>Optional 15 V DC, 0.5 A input connector to supply the Motor Control board logic separately from the motor power stage.</p> <ol style="list-style-type: none"> 15 V DC Power Supply VSS Power
J2		<p>15 V DC output connector to supply the Optoisolation board.</p> <ol style="list-style-type: none"> 15 V DC Power Supply VSS Power
J3		<p>Up to 42 V DC or 30 Veff AC power supply input connector.</p> <ol style="list-style-type: none"> Earth Power Input (AC/DC) Power Input (AC/DC)
J4		<p>AC motor power connector (when overriding internal power inverter).</p> <ol style="list-style-type: none"> MCO0 – Motor Control Output 0 MCO2 – Motor Control Output 2 MCO4 – Motor Control Output 4 MCO1 – Motor Control Output 1 MCO3 – Motor Control Output 3 MCO5 – Motor Control Output 5 MCES – Motor Control Emergency Stop Selectable between 5 V and MCES (see W8 Jumper) Selectable between 5 V and 15 V (see W7 Jumper) VSS Board

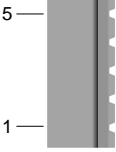
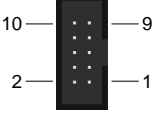
Name	Reference	Description/Pinout
J5		<p>LIN output connector.</p> <ol style="list-style-type: none"> 1. BAT – LIN Transceiver External Supply Voltage 2. LIN – Bidirectional I/O 3. VSS Board
J6		<p>BLDC motor power connector (when overriding internal power inverter).</p> <ol style="list-style-type: none"> 1. MCES – Motor Control Emergency Stop 2. VSS Board 3. MCO1 – Motor Control Output 1 4. VSS Board 5. MCO0 – Motor Control Output 0 6. VSS Board 7. MCO3 – Motor Control Output 3 8. VSS Board 9. MCO2 – Motor Control Output 2 10. VSS Board 11. MCO5 – Motor Control Output 5 12. VSS Board 13. MCO4 – Motor Control Output 4 14. VSS Board 15. 15 V DC Power Supply 16. VSS Board 17. MCIA – Motor Control Input A 18. VSS Board 19. MCIB – Motor Control Input B 20. VSS Board 21. MCIC – Motor Control Input C 22. VSS Board 23. OAP – Operational Amplifier Input 24. VSS Board 25. 5 V DC Power Supply 26. VSS Board

5

Name	Reference	Description/Pinout
J7		<p>LIN control connector.</p> <ol style="list-style-type: none"> 1. WUP – LIN Wake-Up Input 2. INH – LIN Inhibit Output 3. EN – LIN Enable Input 4. 2.2 KOhm Pull-Up Resistor to 5 V (enables the LIN transceiver when adding a jumper between pin 3 and pin 4)
J11		<p>Motor phases and additional monitor signals. Also used to connect the “Alternate Z Sampling” daughter board (for classic sensorless control method).</p> <ol style="list-style-type: none"> 1. Motor Phase C 2. VSS Board 3. Motor Phase B 4. VSS Board 5. Motor Phase A 6. VSS Board 7. MCVREF – Motor Control Voltage Reference
J12		<p>Motor three phases output.</p> <ol style="list-style-type: none"> 1. Motor Phase C 2. Motor Phase A 3. Motor Phase B 4. DC Bus Middle Point (may be used for bi-phase motors) 5. Earth
J13		<p>ICC connector, to be used with inDART-STX to download/debug code.</p> <ol style="list-style-type: none"> 1. VSS Board 2. ICCDATA 3. VSS Board 4. ICCCLK 5. VSS Board 6. RESET# 7. 5 V DC Power Supply 8. VPP 9. N.C. 10. VSS Board

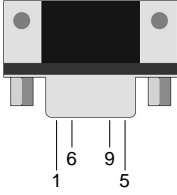
Name	Reference	Description/Pinout
J16		<p>Tachometer input connector for AC motor speed loop control.</p> <ol style="list-style-type: none"> 1. Tachometer Bias (0.6 V) 2. Tachometer Input
J17		<p>External analog input connected to the AIN9 pin of the ST7FMC (available to the user).</p> <ol style="list-style-type: none"> 1. Analog Input (filtered with a 1 KOhm/10 nF RC network) 2. VSS Board
J18		<p>External digital I/O connected to the PF3 pin of the ST7FMC (available to the user).</p> <ol style="list-style-type: none"> 1. Digital Input (47 KOhm pull-up resistor to 5 V and 10 nF debouncing capacitor: allows to directly connect a push-button or switch). 2. VSS Board
J19		<p>Hall sensors input connector.</p> <ol style="list-style-type: none"> 1. Hall Sensor Input 1 2. Hall Sensor Input 2 3. Hall Sensor Input 3 4. 5 V DC Power Supply 5. VSS Board
P1		<p>RS-232 connector.</p> <ol style="list-style-type: none"> 1. N.C. 2. RX 3. TX 4. Tied to Pin 6 5. 0 V 6. Tied to Pin 4 7. Tied to Pin 8 8. Tied to Pin 7 9. N.C.

5

5.8.3 Jumper Settings for a BLDC Motor (Default)

Table 5.8: Jumper Settings Example for a BLDC Motor

Jumper	Settings for the Default AMETEK 24 V BLDC Motor	Settings for a Generic High-Voltage BLDC Motor
S1	"<35V ONLY"	"<35V ONLY" or "HIGH VOLTAGE"
W3	Present	
W4	Present	
W5	Present	
W6	Not present	
W7	Not present	
W8	Not present	
W9	Not present	
W10	Lower position	
W11	Lower position	
W12	"VARIABLE"	
W13	Not present	
W14	Sensorless mode (default): all jumpers in upper position Sensor mode: all jumpers in lower position	
W15		
W16		
J8	No jumper present	
J9	All jumpers present	
J10	No jumper present	
J15	All jumpers present	

5.8.4 Jumper Settings for an AC Motor

Table 5.9: Jumper Settings Example for an AC Motor

Jumper	Settings for a Generic AC Motor, Onboard Inverter Power Stage, Tachometer Feedback
S1	"<35V ONLY" or "HIGH VOLTAGE"
W3	Present
W4	Present
W5	Present
W6	Not present
W7	Not present
W8	Not present
W9	Not present
W10	Lower position
W11	Lower position
W12	"VARIABLE"
W13	Present
W14	Lower position
W15	Lower position
W16	Not present
J8	All jumpers present
J9	All jumpers present
J10	No jumper present
J15	All jumpers present

6 AK-ST7FMC Control Panel Features

6.1 Introduction

Note: *the AK-ST7FMC Control Panel doesn't reflect the full capabilities of the ST7FMC microcontroller and uses only partially its built-in resources. To take full advantage of the ST7FMC capabilities, it may be necessary to bypass the AK-ST7FMC Control Panel and edit directly the ST7FMC firmware. For instance, sinewave control of PMAC motors with sensors is not implemented in the AK-ST7FMC Control Panel at the time of printing and requires a separate firmware.*

It can be the case that for a specific motor (e.g. PMAC or BLDC compressor with load condition) the AK-ST7FMC Control Panel doesn't provide enough flexibility to be used for motor driving (start-up and/or run). In this case, separate fine tuning of the ST7FMC firmware is needed for optimum start-up algorithm and maximum speed.

6

6.1.1 Suggested BLDC Motor Learning Steps

1. Run the provided AMETEK motor and use the AK-ST7FMC Control Panel default settings to understand the interdependence of the various parameters.
2. Then, run your own motor in Sensorless, Open Loop mode in order to find the correct start-up sequence setting. Preferably, select Voltage mode: this allows the motor to take as much current as needed (within the maximum current limit acceptable by the motor) and ensures a successful start-up.
3. Set the correct alignment parameters and acceleration phase parameters. In the Real-Time Settings parameter group, set a duty cycle at least equal to the acceleration phase's. Click the **"START"**

button and, in case the motor fails to start, adjust start-up settings and/or advanced settings. When the motor starts, adjust the delay coefficients for a given duty cycle (speed) to get the best motor efficiency.

4. After the Open Loop mode start-up parameters and advanced settings have been fine tuned, the motor can then be run in Closed Loop mode based on these parameters.
5. In Closed Loop mode, start-up parameters must be set again to comply with the closed loop operation.
6. It is then possible to run the motor in standalone mode by collecting real-time data and generating the appropriate header files to be used with the provided Motor Control library, in order to generate a firmware to be programmed into the microcontroller. This is explained in detail in the “Preparing for Standalone Mode: BLDC Motors” section on page 42.

6.1.2 Suggested AC Motor Learning Steps

1. We suggest you to order the SELNI motor and experiment with the AK-ST7FMC Control Panel’s default settings for this motor, to understand the interdependence of the various parameters.
2. Then, run your own motor in Open Loop mode with a speed sensor (this will allow to monitor the speed and ensure that the stator frequency doesn't go below the rotor frequency—otherwise reactive current will be generated by the motor, causing overvoltage on bulk capacitors and possibly destruction of the board) in order to characterize the motor and/or to verify that the motor is suitable for the intended load.
3. After the V/F curve, the start-up parameters and the advanced settings have been fine tuned, the motor can then be run in Closed Loop mode.
4. In Closed Loop mode, start-up parameters must be set again to comply with the closed loop operation.
5. It is then possible to run the motor in standalone mode by collecting real-time data and generating the appropriate header files to be used with the provided Motor Control library, in order to generate a firmware to be programmed into the microcontroller. This is explained in detail in the “Preparing for Standalone Mode: AC Motors” section on page 46.

6.2 Motor Type Choice

When starting the AK-ST7FMC Control Panel, you must choose which motor type you are working with.

Table 6.1: AK-ST7FMC Control Panel: Motor Type Choice

Parameter Name	Parameter Values/Description	
Motor Type Choice	3 Phase Brushless Permanent Magnet AC or DC Motor (Trapezoidal)	Controls the BLDC blower included in the AK-ST7FMC Starter Kit or any other BLDC motor/compressor, including PMAC wound motors in six-step mode. MDTG write-once register, bit PCN at 0.
	3 Phase AC Induction Motor (Sinewave)	Controls the SELNI three-phase induction motor (not included in the AK-ST7FMC Starter Kit) or any other three-phase induction motor/compressor in sinewave mode. MDTG write-once register, bit PCN at 1.

6.3 BLDC Motor Parameters

This set of parameters allows you to control the AMETEK BLDC blower included the kit or any other BLDC motor/compressor, including PMAC wound motors in six step mode. Please ensure that the correct jumper settings have been set on the board.

AK-ST7FMC Control Panel Features

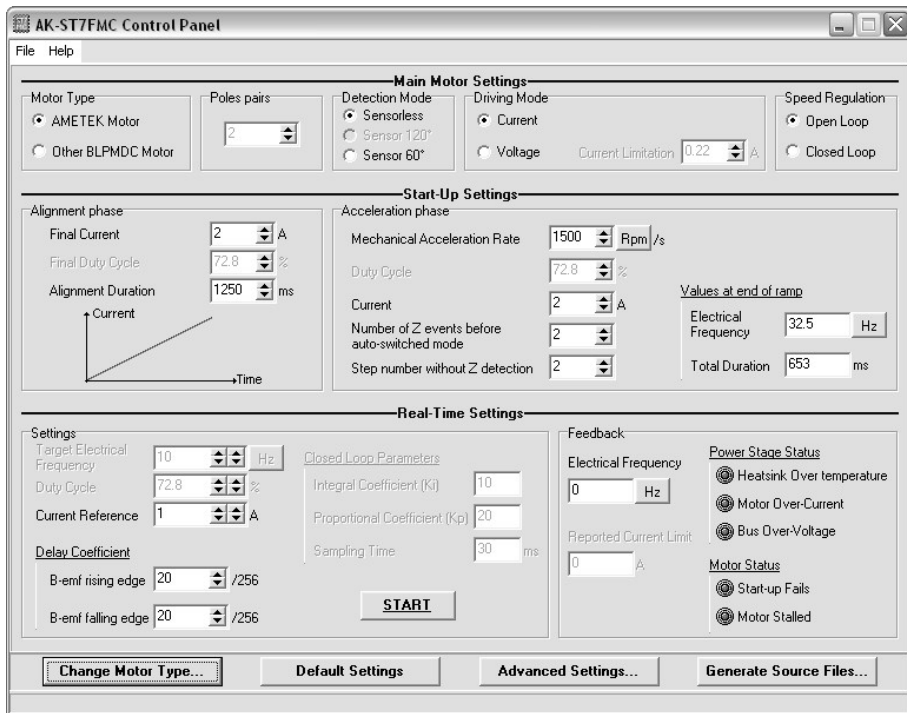

Figure 6.1: AK-ST7FMC Control Panel Main Window for BLDC Motors

Note: In the following tables, the name of the ST7FMC registers corresponding to the AK-ST7FMC Control Panel settings is reported in bold when applicable. This is in order to help you establish an easy link between the AK-ST7FMC Control Panel and the information available in the microcontroller datasheet.

6.3.1 Main Motor Settings

Table 6.2: AK-ST7FMC Control Panel: BLDC Motor Main Settings

Parameter Name	Parameter Values/Description	
Motor Type	AMETEK Motor	An AMETEK 24 V BLDC blower is the default motor included in the AK-ST7FMC Starter Kit. This motor features 3 Hall sensors but is controlled in Sensorless mode by default. It can also be controlled in Sensor mode (see below). The “ Default Settings ” button restores the best performance settings for this motor.
	Other BLDC Motor	Any other BLDC motor (including compressor) with or without sensors can be controlled by the AK-ST7FMC Starter Kit. Motors (including compressors) wound to use sinewave mode (so called PMAC motors) can also be controlled with optimum results in trapezoidal mode. Note that all basic and advanced parameters are by default those chosen for the AMETEK motor. It is unlikely that these settings will suit your motor. The AK-ST7FMC Control Panel can help you find these parameters.
Poles Pair	Number of pair poles of the motor connected to the Starter Kit. BLDC motors with up to 18 pairs of poles can be used.	
Detection Mode	Sensorless	The default sensorless control method is the STMicroelectronics patented three-resistor method. Other standard sensorless methods can be implemented by modifying the Motor Control board hardware and by selecting the appropriate BEMF sampling method. All sensorless methods implemented in this Starter Kit use a six-step signal driving topology. MCRA register, bit SR at 0.
	Sensor 120°	To run the motor in Sensor mode you need to properly set jumpers W14, W15, W16. You need to connect sensors and respect sensor wiring. MCRA register, bit SR at 1.

Parameter Name	Parameter Values/Description	
	Sensor 60°	To run the motor in Sensor mode you need to properly set jumpers W14, W15, W16. For the AMETEK motor the wiring of sensors provided is compatible with the firmware to control the motor in Sensor mode. For other motors you need to connect sensors and respect sensor wiring (and modify jumper settings accordingly). MCRA register, bit SR at 1.
Driving Mode	Current Mode	In this mode, a current reference is set either by the user (in Open Loop mode) or by the PI (Proportional Integral regulator) to reach or maintain target speed (in Closed Loop mode). The ST7FMC motor control peripheral automatically adapts the PWM duty cycle to maintain the current in the motor at the level of the current reference. MCRA register, bit V0C1 at 1.
	Voltage Mode	Voltage mode is preferred in applications requiring high torque at start-up and applications with significant load variations. In this mode, a PWM duty cycle is set by the user (in Open Loop mode) or by the PI (Proportional Integral regulator) to reach or maintain target speed (in Closed Loop mode). MCRA register, bit V0C1 at 0.
Current Limitation	When using Voltage mode, a programmable current limitation can be set. The AK-ST7FMC Control Panel doesn't allow to set this value in real time (the motor needs to be stopped each time). However, in the actual application, the maximum current value can be programmed and modified by software in real time (by varying the 8-bit ARTimer or 12-bit PWM duty cycle and connecting the 8-bit ARTimer or 12-bit PWM output to the proper RC circuit, this RC circuit being connected to the current comparator input). MCPVH and MCPVL compare registers.	
Speed Regulation	Open Loop	No speed regulation (no Proportional Integral regulation) is available. The motor is controlled directly by the user through duty cycle (voltage mode) or current reference (current mode). Useful to fine tune the start-up parameters and the BEMF rising and falling edge coefficients.

Parameter Name	Parameter Values/Description	
	Closed Loop	Proportional Integral regulation is available (this is done by software in the MCU). The user sets a desired speed: based on the PI values for this speed, the MCU defines a duty cycle (voltage mode) or a current reference (current mode). Closed Loop mode is used to implement a fine speed response and regulation.

6.3.2 Start-Up Settings

A successful motor start-up is a start-up that occurs 100% of the times and in a very short time. To achieve a successful start-up, two phases are required: the alignment phase and the acceleration phase. The start-up method implemented in AK-ST7FMC Control Panel is only one among many different start-up methods. For some motors it may be necessary to implement a start-up strategy different than the one proposed in the AK-ST7FMC Control Panel. This will require the ST7FMC firmware to be edited directly without using the AK-ST7FMC Control Panel.

The alignment phase consist in rotating the motor in a know position and to stabilize the rotor before starting. To achieve this, a voltage or current ramp is supplied to the motor (increasing current or increasing duty cycle depending on Current or Voltage mode). During the alignment phase, the motor is polarized with a fixed step configuration T1-T4-T6 (no rotating statoric field).

The acceleration phase is a phase during which synchronous rotation is forced on the motor with a fixed acceleration rate in order to get BEMF information and switch as soon as possible from Forced mode to Autoswitched mode (for more information about Forced mode and Autoswitched mode please refer to the ST7FMC microcontroller datasheet).

Table 6.3: AK-ST7FMC Control Panel: BLDC Motor Start-Up Settings

Parameter Name	Parameter Description
Final Current	In Current mode, sets the final current at the end of the programmed alignment time. MCPVH and MCPVL compare registers.
Final Duty Cycle	In Voltage mode, sets the final duty cycle at the end of the programmed alignment time. MCPUH and MCPUL compare registers.
Alignment Duration	The alignment duration is the duration of the alignment phase. MCOMP (data) and MPRSR (clock) registers.
Mechanical Acceleration Rate	The acceleration phase is a phase during which synchronous rotation is forced on the motor with a fixed acceleration rate in order to get BEMF information and switch from the forced mode to the autoswitched mode as soon as possible. Forced mode: MCRA register, SWA bit at 0. Autoswitched mode: MCRA register, SWA bit at 1. To achieve mechanical acceleration, a 64-step acceleration ramp is built, based on this parameter. 64 steps are usually more than enough to safely reach Autoswitched mode. If Autoswitched mode cannot be reached by the end of the acceleration ramp, the motor will stop and the “Start-Up Fails” or “Motor Stalled” (if rotor blocked) red icon turns on. This value can be set in Hz/s or RPM/s (click the “Hz” or “RPM” button next to the edit box to switch between units).
Duty Cycle	Constant duty cycle applied during the acceleration phase. MCPUH and MCPUL compare registers.
Current	Constant current reference applied during the acceleration phase. MCPVH and MCPVL compare registers.
Number of Z Events Before Autoswitched Mode	Number of consecutive Z events that must be detected to switch to Autoswitched mode.
Step Number without Z detection	Number of first steps of the ramp which are blanked (no BEMF reading). During the very first steps of the acceleration, the BEMF may be too low to be detected. During these first steps, the BEMF detection should be inhibited.

Parameter Name	Parameter Description
Electrical Frequency	Theoretical projected mechanical speed based on the 64th step duration and acceleration rate. Based on the number of pairs of poles and acceleration rate, the AK-ST7FMC Control Panel will compute the length of all of the elementary 64 electrical steps of the acceleration ramp and therefore provide a projection of the mechanical frequency at the end of the 64 steps (this is a theoretical value, as it is unlikely that 64 steps are actually needed to start-up the motor—typically the motor control will be switched to Autoswitched mode within the first 10 steps). This value can be set in Hz or RPM (click the “Hz” or “RPM” button next to the edit box to switch between units).
Total Duration	Theoretical duration of the acceleration phase if all of the 64 steps are completed.

6.3.3 Real-Time Settings

Table 6.4: AK-ST7FMC Control Panel: BLDC Motor Real-Time Settings

Parameter Name	Parameter Description
Target Electrical Frequency	<p>Closed Loop target speed. When running in Closed Loop this is a key parameter because, for a given speed, several other parameters in the AK-ST7FMC Control Panel main window (BEMF coefficients, PI control coefficients, sampling time) and in the <i>Advanced Settings</i> window (software demagnetization, and possibly blanking windows/event counters) needs to be fine tuned.</p> <p>This value can be set in Hz or RPM (click the “Hz” or “RPM” button next to the edit box to switch between units).</p> <p>Note: if the desired speed cannot be reached, it may be because of the minimum and maximum speed limits set in the <i>Advanced Settings</i> window. Please also check that the “Switches PWM Minimum Off Time” parameter in the <i>Advanced Settings</i> window is not too high (only when using the STMicroelectronics’ patented three-resistor BEMF sampling method).</p>
Duty Cycle	<p>This is an Open Loop, Voltage Mode parameter. It is used to manually control the speed of the motor.</p> <p>Note: if the desired duty cycle cannot be reached, it may be because of the maximum duty cycle set in the <i>Advanced Settings</i> window. Please also check that the “Switches PWM Minimum Off Time” parameter in the <i>Advanced Settings</i> window is not too high (only when using the STMicroelectronics’ patented three-resistor BEMF sampling method).</p> <p>MCPUH and MCPUL compare registers.</p>
Current Reference	<p>This is an Open Loop, Current Mode parameter. It is used to manually control the speed of the motor.</p> <p>MCPVH and MCPVL compare registers.</p>
Delay Coefficient	<p>Value between 0 and 255 used to compute the delay between the Zero Crossing event (Z) and the Next Commutation event (C).</p> <p>Formula: $\text{Delay} = (\text{Delay Coefficient} * \text{ZTime}) / 256,$</p> <p>where ZTime is the time between the current Zero Crossing event and the previous Zero Crossing event (or the previous two if this has been set in the “Delay Computation” parameter in the <i>Advanced Setting</i> window). Rising and falling edge detection have been differentiated to compensate the small delay due to the imbalance in step time. Imbalance in step time comes from the fact that the Zero Crossing event is not exactly detected at zero but slightly before (falling BEMF) or after (rising BEMF). This is caused by threshold voltage and by the asymmetrical BEMF shape on some motors.</p>

Parameter Name	Parameter Description
BEMF Rising Edge	Sets the coefficient used to compute the delay when the BEMF is rising. MWGHT register.
BEMF Falling Edge	Sets the coefficient used to compute the delay when the BEMF is falling. MWGHT register.
Integral Coefficient (Ki)	Closed Loop parameter. For beginning with a new motor, it is recommended to start from 0. The higher the value, the shorter the time necessary to cancel the static error, but a value too high will render the system unstable.
Proportional Coefficient (Kp)	Closed Loop parameter. The higher the value, the lower will be the static error, but a value too high will render the system unstable.
Sampling Time	The time interval between two PI control samplings. The lower the sampling time the better will be the regulation bandwidth. However, a value too low will not increase the system dynamic response above a certain point, and will consume microcontroller resources.
Electrical Frequency	Rotor speed reading. This value can be read in Hz or RPM (click the “Hz” or “RPM” button next to the value to switch between units).
Reported Duty Cycle	Available in Closed Loop only. Displays the duty cycle computed by the PI control, which is directly applied on power switches (in Voltage mode), or used to modulate the current reference (in Current mode).

6.3.4 Advanced Settings

BLDC motor advanced settings are available by clicking the “**Advanced Settings**” button in the main AK-ST7FMC Control Panel window.

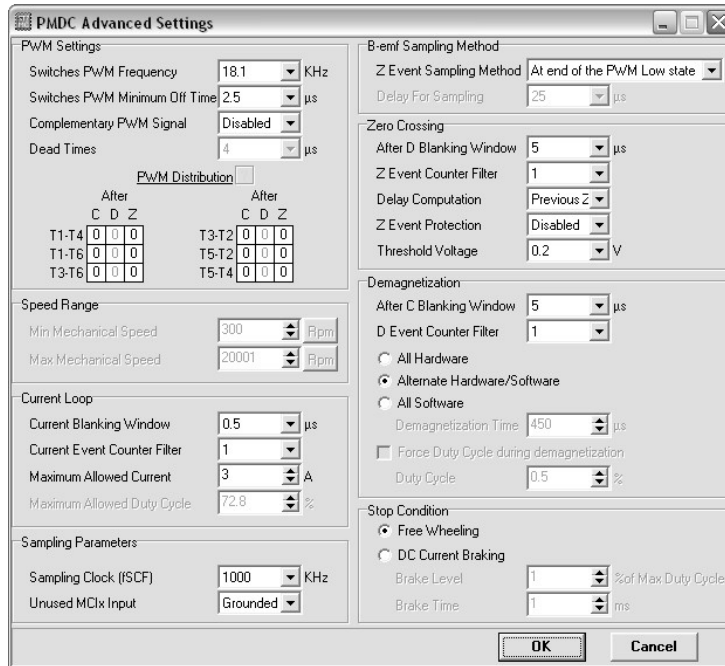

Figure 6.2: BLDC Motor Advanced Settings Dialog Box

Table 6.5: AK-ST7FMC Control Panel: BLDC Motor Advanced Settings

Parameter Name	Parameter Values/Description
PWM Settings	
Switches PWM Frequency	Inverter switches (IGBT/MOSFET) PWM output frequency. In the firmware, the frequency is set as follows: in Voltage mode, the 12-bit timer frequency is set to the desired PWM frequency (MCPOL, MCPOH and MPCR registers); in Current mode, the PWM frequency is selected in the MPRS register, 4 bits from SA3 to SA0 . The output polarity (MPOL register, 6 bits from OP5 to OP0) of the six PWM outputs is fixed for the STMicroelectronics drivers and cannot be changed. For sources using the opposite polarity, please contact STMicroelectronics.
Switches PWM Minimum Off-Time	When using the STMicroelectronics patented three-resistor method, this parameter is required to maintain a sufficient PWM OFF state on the high side of the switches to allow for BEMF reading. This parameter is enabled only when the “ At end of PWM low state ” Z Event sampling method is selected. The BEMF sampling is done during the PWM OFF state, but just before the ON state. The optimum OFF time should be carefully calculated depending on the PWM switching frequency and on motor behavior (mainly the motor stray capacitance). MPWME register, 4 bits from OT3 to OT0.
Complementary PWM Signal	Only when using MOSFETs (instead of the Motor Control board's onboard IGBTs), this feature can be enabled to perform synchronous rectification, allowing the free wheeling current to pass inside the MOSFETs instead of the body diode (reduced power losses). The “ Dead Times ” parameter (see below) must be set correctly. Compl. PWM disabled: MDTG write-once register, bit DTE at 0. Compl. PWM enabled: MDTG write-once register, bit DTE at 1.
Dead Times	Sets the deadtime between the switches' high and low side to avoid cross conduction. The inverter of the Motor Control board requires a minimum deadtime of 0.625 μ s to avoid cross conduction problems. Values from 0.625 μ s to 16 μ s are available in the AK-ST7FMC Control Panel. However, values as low as 0.125 μ s can be set when editing ST7FMC registers directly. This allows to modify the deadtime in case an external inverter power stage is connected to the board. MDTG write-once register, 6 bits from DTG5 to DTG0.



Parameter Name	Parameter Values/Description
PWM Distribution	<p>Sets PWM signal distribution between the switches' high side and low side (respectively even and odd) after each C, D and Z event. Double click to toggle from 0 to 1 and vice versa.</p> <p>For each step it is possible to select on which active switch the PWM signal is applied after the 3 different events (C, D and Z). This is useful to accelerate demagnetization and to reduce the level of reactive current inside the winding.</p> <p>Example: on step T1-T4, T1 is the high side (even) and T4 is the low side (odd). Setting the corresponding "After C" value to 1 causes the PWM signal to be applied on the odd switch (T4) from the C event until the D event; setting the "After D" value to 0 causes the PWM signal to be applied on the even switch (T1) from the D event until the Z event; setting the "After Z" value to 1 causes the PWM signal to be applied on the odd switch (T4) from the Z event until the next C event.</p> <p>MCRB register, 3 bits from OS2 to OS0.</p>
Speed Range	
Minimum Mechanical Speed	<p>Available in Closed Loop only. Speed below which you do not want the motor to run. This can be useful in Sensorless mode, to avoid going below a speed that doesn't allow to generate enough BEMF.</p> <p>This value can be set in Hz or RPM (click the "Hz" or "RPM" button next to the edit box to switch between units).</p>
Maximum Mechanical Speed	<p>This is a safety value.</p> <p>Example: for a motor with a specification of 20,000 RPM absolute maximum, set the same value; if this speed is exceeded, the rotor may be explode or ball bearings may get damaged, and in turn this may cause major injuries (the rotor may be blocked instantaneously, causing the whole motor chassis to turn as a reaction). Always fix securely the motor on a mechanical bench.</p> <p>This value can be set in Hz or RPM (click the "Hz" or "RPM" button next to the edit box to switch between units).</p>
Current Loop	
Current Blanking Window	<p>Used to prevent the Current Loop from stopping on a current spike after PWM ON. This spike is usually caused by the recovery current from the half-bridge free wheeling diode and can be further increased by the discharge of the motor winding stray capacitance. The blanking window starts after each PWM ON event and during this blanking window no reading of current is done. This blanking window can also be disabled.</p> <p>MCFR register, 3 bits from CFW2 to CFW0.</p>
Current Event Counter Filter	<p>Number of consecutive current comparator samples (at 1 MHz) required to switch the PWM signal to OFF.</p> <p>MCFR register, 3 bits from CFF2 to CFF0.</p>

Parameter Name	Parameter Values/Description	
Maximum Allowed Current	In Current mode, to avoid damaging the motor, the user can set a maximum current acceptable for the motor. This value cannot be exceeded by the PI control (in Closed Loop) and by the current reference real-time setting (in Open Loop). However, this value can be exceeded during the start-up phase (Alignment Phase and Acceleration Phase). The AK-ST7FMC Control Panel the maximum current value is clamped to 8.7 A to suit the starter kit hardware.	
Maximum Allowed Duty Cycle	In Voltage mode, the user can specify a maximum PWM duty cycle that the application can't exceed. This value cannot be exceeded by the PI control (in Closed Loop) and by the duty cycle real-time setting (in Open Loop). However, this value can be exceeded during the start-up phase (Alignment Phase and Acceleration Phase). When using the STMicroelectronics' patented three-resistor control method (" Z Event Sampling Method " parameter set to " At the end of the PWM low state "), the maximum PWM duty cycle is clamped to a value (calculated by the AK-ST7FMC Control Panel) which is based on the programmed PWM signal frequency and on the minimum off time. Clamping the maximum PWM signal duty cycle to this value allows for sufficient time for BEMF reading during the PWM OFF state.	
D and Z Sampling Parameters		
Sampling Clock (fSCF)	Sampling frequency used for detecting D events. The same sampling frequency is used for detecting Zero Crossing events, when the (" Z Event Sampling Method " parameter is set to " At PWM On, with delay, at fSCF frequency " or to " At fSCF frequency ". MSCR register, 2 bits from SCF1 to SCF0.	
Unused MCIx Input	Sets the state of the two phases that, at any given time, are not sampled (while the third phase is being sampled). When using STMicroelectronics' patented three-resistor sensorless method, unused MCIx input are grounded. MSCR register, DISS bit.	
BEMF Sampling Method		
Z Event Sampling Method	At end of the PWM low state	To be used with STMicroelectronics patented three-resistor control method. This method uses the default jumper setting of the Motor Control board.
	At PWM on, with delay, once	To be used with sensorless classic control method. The "Alternate Z Sampling" daughter board must be used, and jumpers in the Motor Control board must be set accordingly.
	At PWM on, with delay, at fSCF frequency	Classic automotive method. The "Alternate Z Sampling" daughter board must be used, and jumpers in the Motor Control board must be set accordingly.



Parameter Name	Parameter Values/Description	
	At fSCF frequency	Pulse Amplitude Modulation method. The Motor Control board needs to be significantly modified. The figure at the end of this table illustrates these four sampling methods. MCRC register, SPLG bit and MCONF register, 4 bits from DS3 to DS0.
Delay for Sampling	The delay between the PWM signal rising edge and start of BEMF sampling. This feature is only applicable to “ At PWM on, with delay, once ” and “ At PWM on, with delay, at fSCF frequency ” Z sampling methods. MCONF register, 4 bits from DS3 to DS0.	
Zero Crossing		
After D Blanking Window	Protects against noise that may be wrongly interpreted as a Zero Crossing event. After commutation, there is a time window during which a Zero Crossing event cannot physically occur. During this time window there should not be Z sampling. MZFR register, 4 bits from ZWF3 to ZWF0.	
Z Event Counter Filter	Protects against Zero Crossing (Z) spurious information. It's possible to detect from 1 to 15 Zero Crossing events before validating the Z event. MZFR register, 4 bits from ZEF3 to ZEF0.	
Delay Computation	Formula: $\text{Delay} = (\text{Delay Coefficient} * \text{ZTime}) / 256$ When calculating the Delay value (see the “ Delay Coefficient ” parameter in the Real-Time Settings group), Ztime is the time between the current Zero Crossing event and the one before, or between the previous Zero Crossing event and the one preceding it. Usually, “ Current ” is used. “ Previous ” can be selected to compensate for asymmetrical step times. MCRA register, DCB bit.	
Z Event Protection	If enabled, the Motor Control board verifies that, when a Zero Crossing event is detected, the state of the BEMF signal was opposite at the previous sampling. This is needed to differentiate a BEMF Zero Crossing event from a End-of-Demagnetization event. This feature can be useful when using hardware End-of-Demagnetization event detection and running the motor at high speed. When this parameter is enabled, the “ Z Event Counter Filter ” parameter is disabled. MCRA register, PZ bit.	

Parameter Name	Parameter Values/Description	
Threshold Voltage	<p>When using the STMicroelectronics' patented sensorless BLDC method, this parameter sets the voltage of the second comparator input (the voltage to be compared to BEMF, first comparator input being the BEMF). A list of pre-set values is available.</p> <p>When using other BEMF sampling methods, requiring the reconstruction of the motor ground, the external threshold option (“Ext. Ref.” value) should be selected, and the corresponding hardware should be implemented on the Motor Control board.</p> <p>MCRC register, 3 bits from VR2 to VR0.</p>	
After C Blanking Window	<p>Protect against noise that may be wrongly interpreted as an End-of-Demagnetization (D) event. After commutation, there is a time window during which an End-of-Demagnetization event cannot physically occur. During this time window there should not be D sampling.</p> <p>MDFR register, 4 bits from DWF3 to DWF0.</p>	
D Event Counter Filter	<p>Protects against End-of-Demagnetization (D) spurious information. It's possible to detect from 1 to 15 D events before validating the D event.</p> <p>MDFR register, 4 bits from DEF3 to DEF0.</p>	
Demagnetization	All Hardware	<p>The End-of-Demagnetization event is detected only by hardware.</p> <p>MCRB register, bit HDM at 1, bit SDM at 0.</p>

6

Parameter Name	Parameter Values/Description
	<p data-bbox="444 240 550 310">Alternate Hardware/ Software</p> <p data-bbox="652 240 1109 508">It is possible to get more reliable End-of-Demagnetization event detection by using hardware detection together with software detection. This consists in extending by software (after the hardware detection of D event) the total demagnetization time before validating the End-of-Demagnetization event. In both the AK-ST7FMC Control Panel and in the ST7FMC firmware, this is implemented by multiplying the detected hardware demagnetization time by 1.25, as in the following formula:</p> <p data-bbox="652 548 1023 589">Total demagnetization time = Hardware demagnetization time * Ked,</p> <p data-bbox="652 630 1109 727">where Ked = 1.25. However, when editing directly the ST7FMC firmware, it is possible to change the Ked value and it is also possible add a fixed time, i.e.:</p> <p data-bbox="652 768 1023 808">Total demagnetization time = Hardware demagnetization time * Ked + Ved,</p> <p data-bbox="652 849 1109 922">where Ved is a time set by the user and which depends on several parameters, including motor speed (see the “All Software” below).</p> <p data-bbox="652 930 1076 946">MCRB register, bit HDM at 1, bit SDM at 1.</p>

Parameter Name	Parameter Values/Description	
	All Software	In some situations (e.g. when the “ Hardware/Software ” option is not safe enough) it may be necessary to set a demagnetization time. This demagnetization time must always be equal to or higher than the physical demagnetization time of the motor winding. In addition, since the rotor speed will affect directly the step time, it is important, for each speed (or duty cycle in Open Loop, Voltage mode or current reference in Open Loop, Current mode) to set a corresponding software demagnetization time (or duty cycle, or current reference). If the demagnetization time is too long, it will limit the speed that can be reached by the motor. What all of this means is that, when using software demagnetization, you should not significantly modify the target speed, duty cycle, or current reference in the real-time settings (when the motor is running), but you should instead stop the motor, change the software demagnetization time and start the motor again. MCRB register, bit HDM at 0, bit SDM at 1.
Demagnetization Time	Available when the “ All Software ” option above is selected. This time should be longer than the physical demagnetization time of the motor, but short enough not to delay the BEMF detection. For each target speed there should be a different software demagnetization time. MDREG register, 8 bits from DN7 to DN0.	
Force Duty Cycle during Demagnetization	During demagnetization, current circulating in windings where the polarization doesn't change may increase to a level which may damage the motor. To avoid this situation, a dedicated duty cycle can be applied during demagnetization. This feature is available in Sensorless, Voltage mode.	
Duty Cycle	Available when the “ Force Duty Cycle during Demagnetization ” option above is enabled.	
Stop Condition	Free Wheeling	After stop, the motor will continue to spin freely.
	DC Current Braking	To slow down the motor quickly, this feature allows to apply active braking.
Brake Level	Available when the “ DC Current Braking ” option above is selected. Two of the three bridge legs are grounded and a PWM signal with 50% duty cycle (maximum) is applied on the third leg's high side switch. In Voltage mode, the duty cycle is loaded in the MCPUH and MCPUL registers. In Current mode, the current reference is loaded in the MCPVH and MCPVL registers.	

Parameter Name	Parameter Values/Description
Brake Time	Available when the “DC Current Braking” option above is selected. Time during which active braking is applied and after which the motor is free wheeling.

The following figures illustrates the options available for the “Z Event Sampling Method” parameter.

Sampling at end of the PWM OFF state

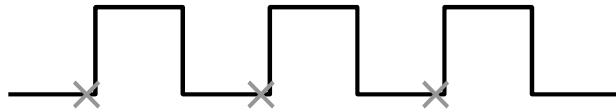

Sampling at PWM ON, with delay, once

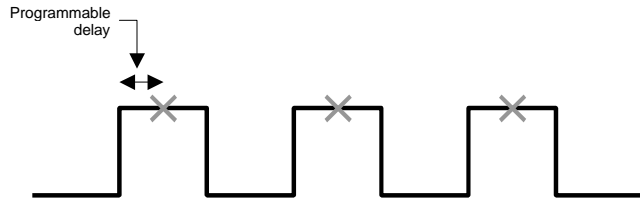

Sampling at PWM ON, with delay, at f_{SCF} frequency

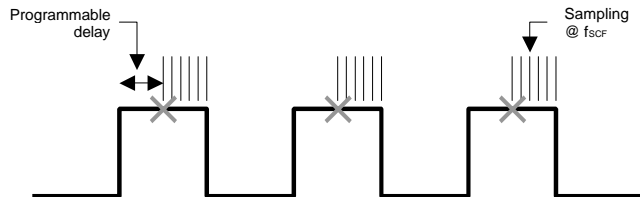

Sampling at f_{SCF} frequency

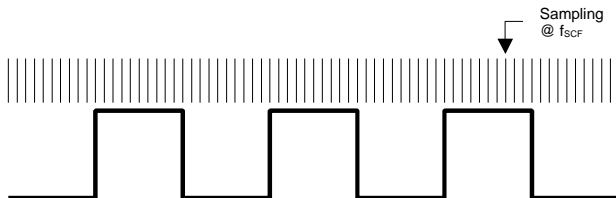

Figure 6.3: BLDC Motor: BEMF Sampling Methods

6

6.4 AC Motor Parameters

This set of parameters allows you to control the SELNI three-phase induction motor (to be ordered separately) or any other three-phase induction motors/compressors in sinewave mode. Please ensure that the correct jumper settings has been set on the board.



Figure 6.4: AK-ST7FMC Control Panel Main Window for AC Motors

6.4.1 Main Motor Settings

Table 6.6: AK-ST7FMC Control Panel: AC Motor Main Settings

Parameter Name	Parameter Values/Description	
Motor Type	SELNI Induction Motor	The SELNI motor is an 800 W, 190 V, three-phase induction motor. It features a tachometer generator for speed monitoring. Due to its size and weight it is not included in the AK-ST7FMC Starter Kit but can be ordered separately. Beginners to three-phase induction motor control are strongly recommended to first use the SELNI motor as a learning phase. The “ Default Settings ” button restores the best performance settings for driving this motor when the Motor Control board is supplied with an input voltage of 42 V DC.
	Other 3-Phase Induction Motor	Any three-phase induction motor with or without sensor (tachometer, encoder, Hall sensor).
Poles Pair	Number of pair of poles of the motor connected to the Starter Kit. Induction motors with up to 2 pairs of poles can be used. Setting the correct number of pairs of poles is important, as this defines the relationship between speed and stator frequency.	
Speed Regulation	Open Loop	Open Loop can be selected for operating the motor with no sensors and predictable load. Open Loop can also be used to drive the motor over the full Voltage/Frequency range. When selecting Open Loop, no Proportional Integer (PI) control is available, but speed monitoring is possible (with the speed sensor). When characterizing the efficiency versus the slip of the motor, the speed sensor must be used. Beware of motor breakdown and reactive current.
	Closed Loop	Closed Loop requires the use of the speed sensor (either a tachometer or an Hall sensor), and uses the PI control (see real-time settings below). PI values must be adjusted depending on load conditions. PI parameters not properly set may lead to unstable behavior, especially in case of no load condition.
Speed Sensor Feedback	Enable this feature if speed monitoring is required in Open Loop for efficiency versus slip characterization.	

6

Parameter Name	Parameter Values/Description
Tachometer Periods per Revolution	Available when the “ Speed Sensor Feedback ” option above is enabled, and specifies the number of poles pair of the tachometer generator (if the tachometer has 8 pairs of poles, then 8 pulses per revolution will be sent). For the SELNI motor, this value is fixed to 8.

6.4.2 V/F Curve Settings

Table 6.7: AK-ST7FMC Control Panel: AC Motor V/F Curve Settings

Parameter Name	Parameter Description
Min Voltage	Sets the maximum allowed voltage (255 corresponds to full bus voltage) for low frequencies. This to avoid stator winding saturation (and, in turn, stator overcurrent).
Low Frequency	Frequency below which voltage cannot go higher than the minimum voltage specified by user.
High Frequency	Frequency above which voltage can go up to the full bus voltage (255/255).

6.4.3 Start-Up Settings

Table 6.8: AK-ST7FMC Control Panel: AC Motor Start-Up Settings

Parameter Name	Parameter Description
Voltage Slew Rate	Open Loop parameter only. Time interval between two voltage increments (1/255).
Start-Up Stator Frequency	Closed Loop parameter only. Inverter output frequency at start-up. This value can be set in Hz or RPM (click the “ Hz ” or “ RPM ” button next to the edit box to switch between units).
Maximum Duration	Closed Loop parameter only. Time after which the motor is considered as not started if no speed information has been detected.
Minimum Rotor Frequency to Validate Closed Loop	This frequency, when reached by the rotor, will trigger true Closed Loop control by exiting the start-up phase and entering the Closed Loop routine (the start-up phase is controlled in Open Loop by default, as no speed information is available during this phase). This value is always smaller than start-up frequency. This value can be set in Hz or RPM (click the “ Hz ” or “ RPM ” button next to the edit box to switch between units).

6.4.4 Real-Time Settings

Table 6.9: AK-ST7FMC Control Panel: AC Motor Real-Time Settings

Parameter Name	Parameter Description
Stator Frequency	Open Loop parameter only. Defines the synchronous speed of the motor. Basically it is the inverter output frequency. This value can be set in Hz or RPM (click the “Hz” or “RPM” button next to the edit box to switch between units).
Set Voltage According to V/F Curve	In Open Loop (and for predictable load systems), this option is useful to adjust the speed without taking care of the applied voltage (the V/F curve has been tuned to fit the load). If this option is disabled, then the voltage can be set in the “Voltage” parameter below.
Voltage	Open Loop parameter only. For a given stator frequency, this is the voltage applied to the stator windings (it can be any voltage below the V/F limit, in other words any voltage within the red area).
Target Rotor Frequency	Closed Loop parameter only. The target rotor speed (frequency) is the expected speed (frequency) of the rotor. The Proportional Integral (PI) control will adjust the stator voltage and frequency according to this target frequency, the slip frequency and the V/F curve. This value can be set in Hz or RPM (click the “Hz” or “RPM” button next to the edit box to switch between units).
Target Slip Frequency	Closed Loop parameter only. The slip value to be entered here should be the slip giving optimum efficiency for the given target rotor frequency and motor characteristics. The PI control will adjust the stator voltage and frequency according to this slip frequency, the target frequency and the V/F curve. This value can be set in Hz or RPM (click the “Hz” or “RPM” button next to the edit box to switch between units).
Integral Coefficient (Ki)	Closed Loop parameter. For beginning with a new motor, it is recommended to start from 0. The higher the value, the shorter the time necessary to cancel the static error, but a value too high will render the system unstable.
Proportional Coefficient (Kp)	Closed Loop parameter. The higher the value, the lower will be the static error, but a value too high will render the system unstable.
Sampling Time	The time interval between two PI control samplings. The lower the sampling time the better will be the regulation bandwidth. However, a value too low will not increase the system dynamic response above a certain point, and will consume microcontroller resources.
Reported Frequency	Only valid in Closed Loop or in Open Loop with speed sensor feedback. This is the speed (frequency) of the rotor as read by the speed sensor. This value can be read in Hz or RPM (click the “Hz” or “RPM” button next to the value to switch between units).

Parameter Name	Parameter Description
Slip Frequency	The slip speed (frequency) is the stator speed (frequency) minus the rotor speed (frequency). This value can be read in Hz or RPM (click the “Hz” or “RPM” button next to the value to switch between units).
Reported Voltage	Voltage output of the PI controller (in units of the bus voltage, full bus voltage being 255/255).

6.4.5 Advanced Settings

AC motor advanced settings are available by clicking the “**Advanced Settings**” button in the main AK-ST7FMC Control Panel window.

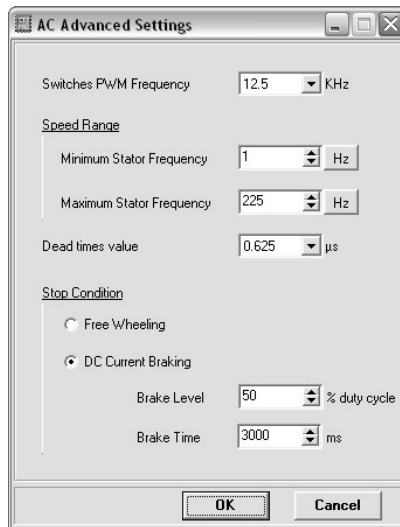

Figure 6.5: AC Motor Advanced Settings Dialog Box



Table 6.10: AK-ST7FMC Control Panel: AC Motor Advanced Settings

Parameter Name	Parameter Values/Description	
Switches PWM Frequency	<p>Inverter switches (IGBT/MOSFET) PMW output frequency.</p> <p>In the firmware, the 12-bit timer frequency is set to the desired PWM frequency (MCPOL, MCPOH and MPCR registers). The output polarity (MPOL register, 6 bits from OP5 to OP0) of the six PWM outputs is fixed for the STMicroelectronics drivers and cannot be changed. For sources using the opposite polarity, please contact STMicroelectronics.</p>	
Minimum Stator Frequency	<p>Speed below which you do not want the motor to run.</p> <p>This value can be set in Hz or RPM (click the “Hz” or “RPM” button next to the edit box to switch between units).</p>	
Maximum Stator Frequency	<p>This is a safety value.</p> <p>Example: for a motor with a specification of 20,000 RPM absolute maximum, set the same value; if this speed is exceeded, the rotor may be explode or ball bearings may get damaged, and in turn this may cause major injuries (the rotor may be blocked instantaneously, causing the whole motor chassis to turn as a reaction). Always fix securely the motor on a mechanical bench.</p> <p>This value can be set in Hz or RPM (click the “Hz” or “RPM” button next to the edit box to switch between units).</p>	
Dead Times Value	<p>Sets the deadtime between the switches’ high and low side to avoid cross conduction. The inverter of the Motor Control board requires a minimum deadtime of 0.625 μs to avoid cross conduction problems. Values from 0.625 μs to 16 μs are available in the AK-ST7FMC Control Panel. However, values as low as 0.125 μs can be set when editing ST7FMC registers directly. This allows the deadtime to be modified in case an external inverter power stage is connected to the board.</p> <p>MDTG write-once register, 6 bits from DTG5 to DTG0.</p>	
Stop Condition	Free Wheeling	After stop, the motor will continue to spin freely.
	DC Current Braking	To slow down the motor quickly, this feature allows to apply active braking.
Brake Level	<p>Available when the “DC Current Braking” option above is selected. Two of the three bridge legs are grounded and a complementary PWM with maximum 50% duty cycle is applied on the switches of the third leg.</p> <p>Duty cycle loaded in the MCPUH and MCPUL registers.</p>	
Brake Time	<p>Available when the “DC Current Braking” option above is selected. Time during which active braking is applied and after which the motor is free wheeling.</p>	

7 Electrical Specifications

Table 7.1: Motor Control Board Electrical Specifications

Parameter	Maximum Ratings
Motor Types	Three-Phase BLDC, Three-Phase AC
Main Input Voltage (J3)	42 V DC or 30 Veff AC
Auxiliary Input Voltage (J1)	15 V DC, 0.5 A
Auxiliary Output Voltage (J2)	15 V DC, 0.5 A
Maximum Output Current on Motor Phases (J12)	10 A
Analog Input Voltage (J17)	5 V DC
Digital Input/Output Voltage (J18)	5 V DC

Table 7.2: Optoisolation Board Electrical Specifications

Parameter	Maximum Ratings
Input Voltage (J3)	15 V DC, 0.3 A
"ICC IN" Connector I/O Lines Voltage (J1)	5 V DC
"ICC OUT" Connector I/O Lines Voltage (J2)	5 V DC



Стандарт Электрон Связь

Мы молодая и активно развивающаяся компания в области поставок электронных компонентов. Мы поставляем электронные компоненты отечественного и импортного производства напрямую от производителей и с крупнейших складов мира.

Благодаря сотрудничеству с мировыми поставщиками мы осуществляем комплексные и плановые поставки широчайшего спектра электронных компонентов.

Собственная эффективная логистика и склад в обеспечивает надежную поставку продукции в точно указанные сроки по всей России.

Мы осуществляем техническую поддержку нашим клиентам и предпродажную проверку качества продукции. На все поставляемые продукты мы предоставляем гарантию .

Осуществляем поставки продукции под контролем ВП МО РФ на предприятия военно-промышленного комплекса России , а также работаем в рамках 275 ФЗ с открытием отдельных счетов в уполномоченном банке. Система менеджмента качества компании соответствует требованиям ГОСТ ISO 9001.

Минимальные сроки поставки, гибкие цены, неограниченный ассортимент и индивидуальный подход к клиентам являются основой для выстраивания долгосрочного и эффективного сотрудничества с предприятиями радиоэлектронной промышленности, предприятиями ВПК и научно-исследовательскими институтами России.

С нами вы становитесь еще успешнее!

Наши контакты:

Телефон: +7 812 627 14 35

Электронная почта: sales@st-electron.ru

Адрес: 198099, Санкт-Петербург,
Промышленная ул, дом № 19, литера Н,
помещение 100-Н Офис 331