



# VNN3NV04P-E VNS3NV04P-E

## OMNIFET II fully autoprotected Power MOSFET

Datasheet – production data

### Features

Type	$R_{DS(on)}$	$I_{lim}$	$V_{clamp}$
VNN3NV04P-E VNS3NV04P-E	120 m $\Omega$	3.5 A	40 V

- Linear current limitation
- Thermal shutdown
- Short circuit protection
- Integrated clamp
- Low current drawn from input pin
- Diagnostic feedback through input pin
- ESD protection
- Direct access to the gate of the Power MOSFET (analog driving)
- Compatible with standard Power MOSFET in compliance with the 2002/95/EC European directive

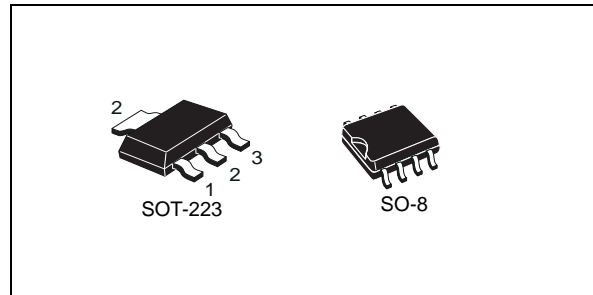

### Description

The VNN3NV04P-E, VNS3NV04P-E, are monolithic devices designed in STMicroelectronics® VIPower® M0-3 Technology, intended for replacement of standard Power MOSFETs from DC up to 50 kHz applications. Built in thermal shutdown, linear current limitation and overvoltage clamp protect the chip in harsh environments.

Fault feedback can be detected by monitoring the voltage at the input pin.

Table 1. Device summary

Package	Order codes	
	Tube	Tape and reel
SOT-223	—	VNN3NV04PTR-E
SO-8	VNS3NV04P-E	VNS3NV04PTR-E

# Contents

<b>1</b>	<b>Block diagram and pin description</b> .....	<b>5</b>
<b>2</b>	<b>Electrical specifications</b> .....	<b>6</b>
2.1	Absolute maximum ratings .....	6
2.2	Thermal data .....	7
2.3	Electrical characteristics .....	7
<b>3</b>	<b>Protection features</b> .....	<b>9</b>
3.1	Electrical characteristics curves .....	12
<b>4</b>	<b>Package and packing information</b> .....	<b>16</b>
4.1	SOT-223 mechanical data .....	16
4.2	SO-8 mechanical data .....	17
4.3	SOT-223 packing information .....	19
4.4	SO-8 packing information .....	20
<b>5</b>	<b>Revision history</b> .....	<b>21</b>

## List of tables

Table 1.	Device summary . . . . .	1
Table 2.	Absolute maximum ratings . . . . .	6
Table 3.	Thermal data . . . . .	7
Table 4.	Electrical characteristics . . . . .	7
Table 5.	SOT-223 mechanical data . . . . .	16
Table 6.	SO-8 mechanical data . . . . .	17
Table 7.	Document revision history . . . . .	21

## List of figures

Figure 1.	Block diagram . . . . .	5
Figure 2.	Configuration diagram (top view) . . . . .	5
Figure 3.	Current and voltage conventions . . . . .	6
Figure 4.	Switching time test circuit for resistive load . . . . .	10
Figure 5.	Test circuit for diode recovery times . . . . .	10
Figure 6.	Unclamped inductive load test circuits . . . . .	11
Figure 7.	Input charge test circuit. . . . .	11
Figure 8.	Unclamped inductive waveforms . . . . .	11
Figure 9.	Thermal impedance for SOT-223 . . . . .	12
Figure 10.	Derating curve . . . . .	12
Figure 11.	Transconductance . . . . .	12
Figure 12.	Static drain-source on resistance vs input voltage (part 1/2) . . . . .	12
Figure 13.	Static drain-source on resistance vs input voltage (part 2/2) . . . . .	12
Figure 14.	Source-drain diode forward characteristics . . . . .	12
Figure 15.	Static drain source on resistance . . . . .	13
Figure 16.	Turn-on current slope (part 1/2) . . . . .	13
Figure 17.	Turn-on current slope (part 2/2) . . . . .	13
Figure 18.	Transfer characteristics . . . . .	13
Figure 19.	Static drain-source on resistance vs $I_d$ . . . . .	13
Figure 20.	Input voltage vs input charge . . . . .	13
Figure 21.	Turn-off drain source voltage slope (part 1/2). . . . .	14
Figure 22.	Turn-off drain source voltage slope (part 2/2). . . . .	14
Figure 23.	Capacitance variations . . . . .	14
Figure 24.	Output characteristics . . . . .	14
Figure 25.	Normalized on resistance vs temperature . . . . .	14
Figure 26.	Switching time resistive load (part 1/2) . . . . .	14
Figure 27.	Switching time resistive load (part 2/2) . . . . .	15
Figure 28.	Normalized input threshold voltage vs temperature . . . . .	15
Figure 29.	Normalized current limit vs junction temperature . . . . .	15
Figure 30.	Step response current limit . . . . .	15
Figure 31.	SOT-223 package dimensions . . . . .	16
Figure 32.	SO-8 package dimensions . . . . .	18
Figure 33.	SOT-223 tape and reel shipment (suffix "TR") . . . . .	19
Figure 34.	SO-8 tube shipment (no suffix) . . . . .	20
Figure 35.	SO-8 tape and reel shipment (suffix "TR") . . . . .	20

# 1 Block diagram and pin description

Figure 1. Block diagram

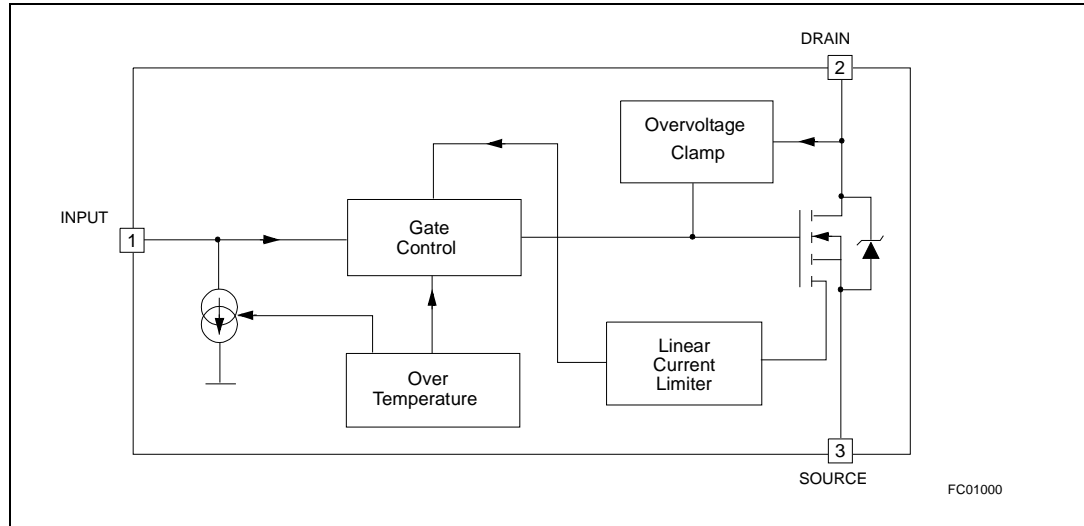
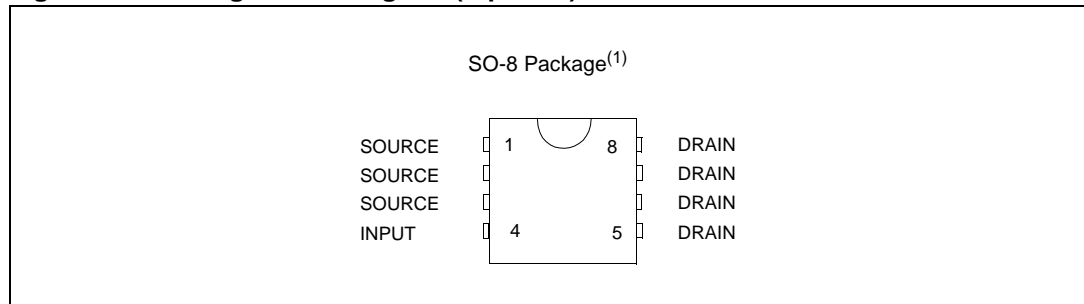

Figure 2. Configuration diagram (top view)



1. For the pins configuration related to SOT-223 see outlines at page 1.

## 2 Electrical specifications

Figure 3. Current and voltage conventions



### 2.1 Absolute maximum ratings

Table 2. Absolute maximum ratings

Symbol	Parameter	Value		Unit
		SOT-223	SO-8	
$V_{DS}$	Drain-source voltage ( $V_{IN} = 0\text{ V}$ )	Internally clamped		V
$V_{IN}$	Input voltage	Internally clamped		V
$I_{IN}$	Input current	+/-20		mA
$R_{IN\text{ MIN}}$	Minimum input series impedance	220		$\Omega$
$I_D$	Drain current	Internally limited		A
$I_R$	Reverse DC output current	-5.5		A
$V_{ESD1}$	Electrostatic discharge ( $R = 1.5\text{ K}\Omega$ , $C = 100\text{ pF}$ )	4000		V
$V_{ESD2}$	Electrostatic discharge on output pin only ( $R = 330\ \Omega$ , $C = 150\text{ pF}$ )	16500		V
$P_{tot}$	Total dissipation at $T_c = 25\text{ }^\circ\text{C}$	7	8.3	W
$T_j$	Operating junction temperature	Internally limited		$^\circ\text{C}$
$T_c$	Case operating temperature	Internally limited		$^\circ\text{C}$
$T_{stg}$	Storage temperature	-55 to 150		$^\circ\text{C}$

## 2.2 Thermal data

**Table 3. Thermal data**

Symbol	Parameter	Value		Unit
		SOT-223	SO-8	
$R_{thj-case}$	Thermal resistance junction-case max	18		°C/W
$R_{thj-lead}$	Thermal resistance junction-lead max		15	°C/W
$R_{thj-amb}$	Thermal resistance junction-ambient max	70 <sup>(1)</sup>	65 <sup>(1)</sup>	°C/W

1. When mounted on a standard single-sided FR4 board with 50 mm<sup>2</sup> of Cu (at least 35 mm thick) connected to all DRAIN pins.

## 2.3 Electrical characteristics

-40°C <  $T_j$  < 150°C, unless otherwise specified.

**Table 4. Electrical characteristics**

Symbol	Parameter	Test conditions	Min	Typ	Max	Unit
<b>Off</b>						
$V_{CLAMP}$	Drain-source clamp voltage	$V_{IN} = 0\text{ V}; I_D = 1.5\text{ A}$	40	45	55	V
$V_{CLTH}$	Drain-source clamp threshold voltage	$V_{IN} = 0\text{ V}; I_D = 2\text{ mA}$	36			V
$V_{INTH}$	Input threshold voltage	$V_{DS} = V_{IN}; I_D = 1\text{ mA}$	0.5		2.5	V
$I_{ISS}$	Supply current from input pin	$V_{DS} = 0\text{ V}; V_{IN} = 5\text{ V}$		100	150	μA
$V_{INCL}$	Input-source clamp voltage	$I_{IN} = 1\text{ mA}$	6	6.8	8	V
		$I_{IN} = -1\text{ mA}$	-1.0		-0.3	V
$I_{DSS}$	Zero input voltage drain current ( $V_{IN} = 0\text{ V}$ )	$V_{DS} = 13\text{ V}; V_{IN} = 0\text{ V}; T_j = 25^\circ\text{C}$			30	μA
		$V_{DS} = 25\text{ V}; V_{IN} = 0\text{ V}$			75	μA
<b>On</b>						
$R_{DS(on)}$	Static drain-source on resistance	$V_{IN} = 5\text{ V}; I_D = 1.5\text{ A}; T_j = 25^\circ\text{C}$			120	mΩ
		$V_{IN} = 5\text{ V}; I_D = 1.5\text{ A}$			240	mΩ
<b>Dynamic (<math>T_j = 25^\circ\text{C}</math>, unless otherwise specified)</b>						
$g_{fs}^{(1)}$	Forward transconductance	$V_{DD} = 13\text{ V}; I_D = 1.5\text{ A}$		5.0		S
$C_{OSS}$	Output capacitance	$V_{DS} = 13\text{ V}; f = 1\text{ MHz}; V_{IN} = 0\text{ V}$		150		pF
<b>Switching (<math>T_j = 25^\circ\text{C}</math>, unless otherwise specified)</b>						
$t_{d(on)}$	Turn-on delay time	$V_{DD} = 15\text{ V}; I_D = 1.5\text{ A}; V_{gen} = 5\text{ V}; R_{gen} = R_{IN\text{ MIN}} = 220\ \Omega$ (see <a href="#">Figure 4</a> )		90	300	ns
$t_r$	Rise time			250	750	ns
$t_{d(off)}$	Turn-off delay time			450	1350	ns
$t_f$	Fall time			250	750	ns

Table 4. Electrical characteristics (continued)

Symbol	Parameter	Test conditions	Min	Typ	Max	Unit	
$t_{d(on)}$	Turn-on delay time	$V_{DD} = 15\text{ V}; I_D = 1.5\text{ A}; V_{gen} = 5\text{ V};$ $R_{gen} = 2.2\text{ K}\Omega$ (see <a href="#">Figure 4</a> )		0.45	1.35	$\mu\text{s}$	
$t_r$	Rise time			2.5	7.5	$\mu\text{s}$	
$t_{d(off)}$	Turn-off delay time			3.3	10.0	$\mu\text{s}$	
$t_f$	Fall time			2.0	6.0	$\mu\text{s}$	
$(di/dt)_{on}$	Turn-on current slope	$V_{DD} = 15\text{ V}; I_D = 1.5\text{ A}; V_{gen} = 5\text{ V};$ $R_{gen} = R_{IN\text{ MIN}} = 220\ \Omega$		4.7		$\text{A}/\mu\text{s}$	
$Q_i$	Total input charge	$V_{DD} = 12\text{ V}; I_D = 1.5\text{ A}; V_{IN} = 5\text{ V};$ $I_{gen} = 2.13\text{ mA}$ (see <a href="#">Figure 7</a> )		8.5		nC	
<b>Source drain diode (<math>T_j=25^\circ\text{C}</math>, unless otherwise specified)</b>							
$V_{SD}^{(1)}$	Forward on voltage	$I_{SD} = 1.5\text{ A}; V_{IN} = 0\text{ V}$		0.8		V	
$t_{rr}$	Reverse recovery time	$I_{SD} = 1.5\text{ A}; di/dt = 12\text{ A}/\mu\text{s};$ $V_{DD} = 30\text{ V}; L = 200\ \mu\text{H}$ (see <a href="#">Figure 5</a> )		107		ns	
$Q_{rr}$	Reverse recovery charge				37		$\mu\text{C}$
$I_{RRM}$	Reverse recovery current				0.7		A
<b>Protections (<math>-40^\circ\text{C} &lt; T_j &lt; 150^\circ\text{C}</math>, unless otherwise specified)</b>							
$I_{lim}$	Drain current limit	$V_{IN} = 5\text{ V}; V_{DS} = 13\text{ V}$	3.5	5	7	A	
$t_{dlim}$	Step response current limit	$V_{IN} = 5\text{ V}; V_{DS} = 13\text{ V}$		10		$\mu\text{s}$	
$T_{jsh}$	Over temperature shutdown		150	175	200	$^\circ\text{C}$	
$T_{jrs}$	Over temperature reset		135			$^\circ\text{C}$	
$I_{gf}$	Fault sink current	$V_{IN} = 5\text{ V}; V_{DS} = 13\text{ V}; T_j = T_{jsh}$	10	15	20	mA	
$E_{as}$	Single pulse avalanche energy	starting $T_j = 25^\circ\text{C}; V_{DD} = 24\text{ V};$ $V_{IN} = 5\text{ V}; R_{gen} = R_{IN\text{ MIN}} = 220\ \Omega;$ $L = 24\text{ mH}$ (see <a href="#">Figure 6</a> and <a href="#">Figure 8</a> )	100			mJ	

1. Pulsed: Pulse duration = 300  $\mu\text{s}$ , duty cycle 1.5 %



### 3 Protection features

During normal operation, the input pin is electrically connected to the gate of the internal Power MOSFET through a low impedance path.

The device then behaves like a standard Power MOSFET and can be used as a switch from DC up to 50 kHz. The only difference from the user's standpoint is that a small DC current  $I_{SS}$  (typ. 100  $\mu$ A) flows into the input pin in order to supply the internal circuitry.

The device integrates:

- Overvoltage clamp protection: internally set at 45 V, along with the rugged avalanche characteristics of the Power MOSFET stage give this device unrivalled ruggedness and energy handling capability. This feature is mainly important when driving inductive loads.
- Linear current limiter circuit: limits the drain current  $I_D$  to  $I_{lim}$  whatever the input pin voltages. When the current limiter is active, the device operates in the linear region, so power dissipation may exceed the capability of the heatsink. Both case and junction temperatures increase, and if this phase lasts long enough, junction temperature may reach the over temperature threshold  $T_{jsh}$ .
- Overtemperature and short circuit protection: these are based on sensing the chip temperature and are not dependent on the input voltage. The location of the sensing element on the chip in the power stage area ensures fast, accurate detection of the junction temperature. Overtemperature cutout occurs in the range 150°C to 190°C, a typical value being 170°C. The device is automatically restarted when the chip temperature falls of about 15°C below shutdown temperature.
- Status feedback: in the case of an overtemperature fault condition ( $T_j > T_{jsh}$ ), the device tries to sink a diagnostic current  $I_{gf}$  through the input pin in order to indicate fault condition. If driven from a low impedance source, this current may be used in order to warn the control circuit of a device shutdown. If the drive impedance is high enough so that the input pin driver is not able to supply the current  $I_{gf}$ , the input pin will fall to 0 V. This will not however affect the device operation: no requirement is put on the current capability of the input pin driver except to be able to supply the normal operation drive current  $I_{SS}$ .

Additional features of this device are ESD protection according to the Human Body model and the ability to be driven from a TTL logic circuit.

Figure 4. Switching time test circuit for resistive load

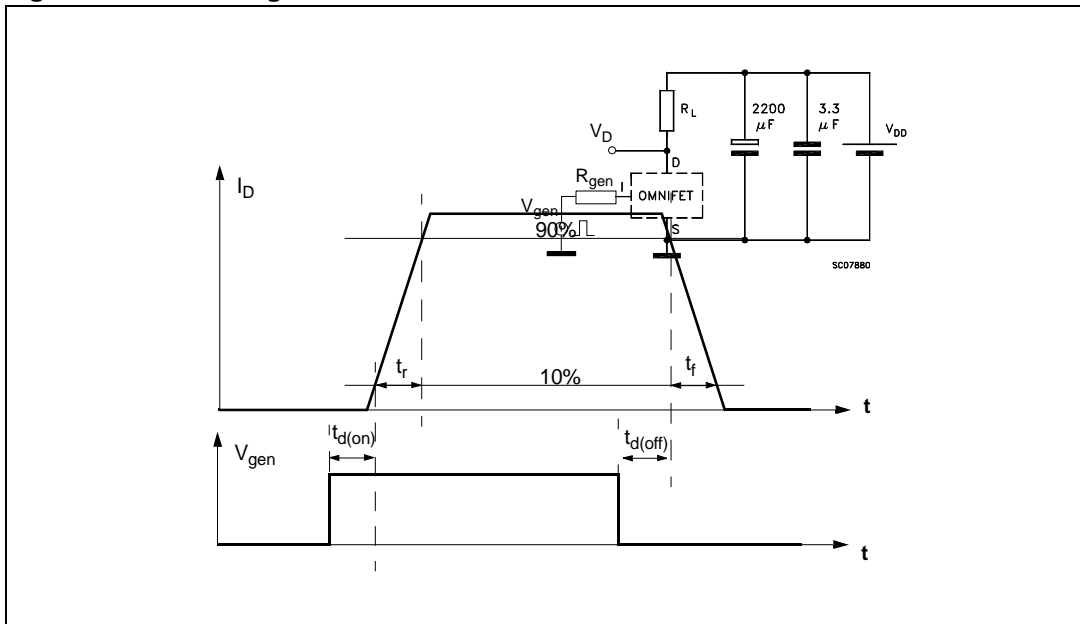

Figure 5. Test circuit for diode recovery times

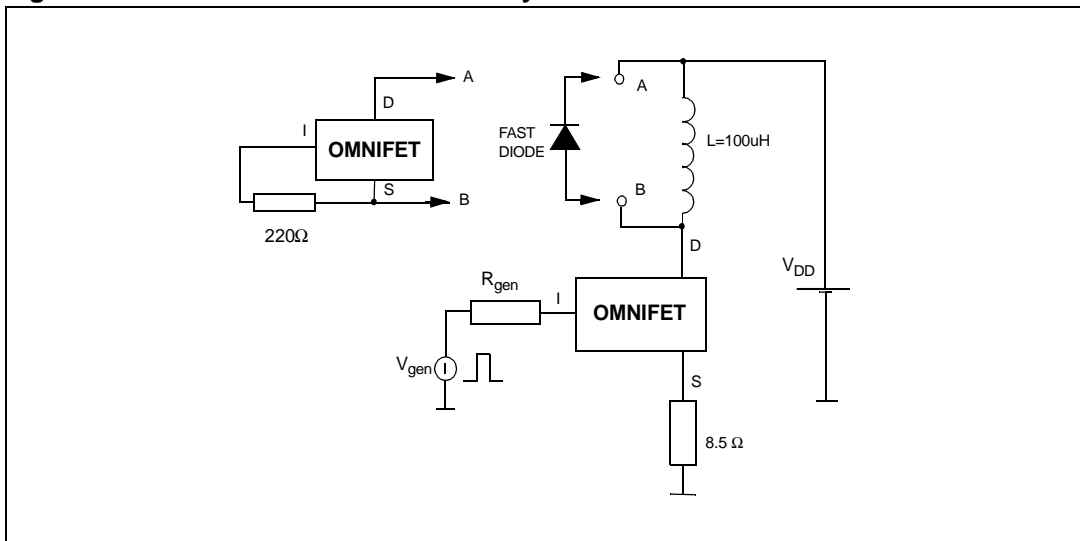

Figure 6. Unclamped inductive load test circuits



Figure 7. Input charge test circuit

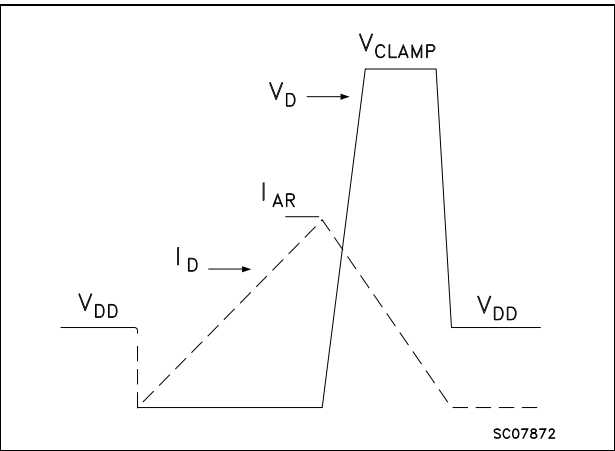

Figure 8. Unclamped inductive waveforms



### 3.1 Electrical characteristics curves

Figure 9. Thermal impedance for SOT-223

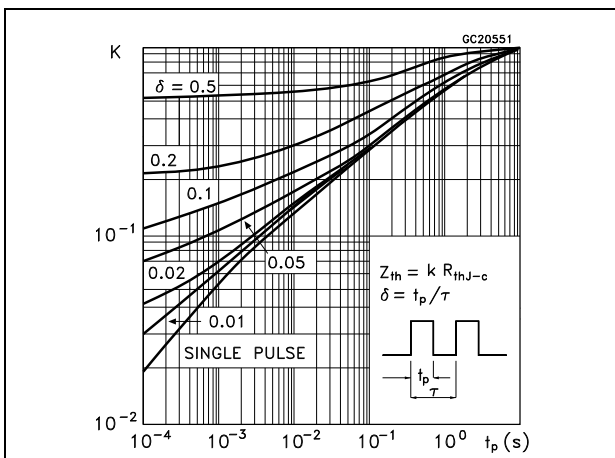

Figure 10. Derating curve

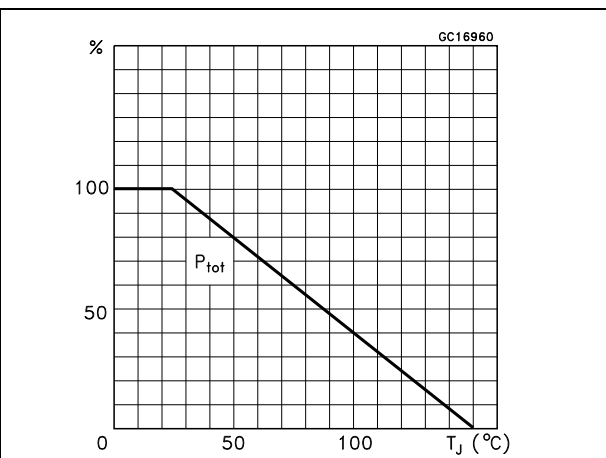

Figure 11. Transconductance

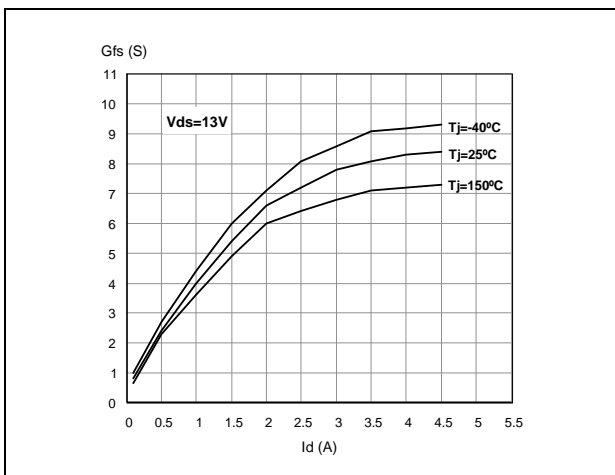

Figure 12. Static drain-source on resistance vs input voltage (part 1/2)

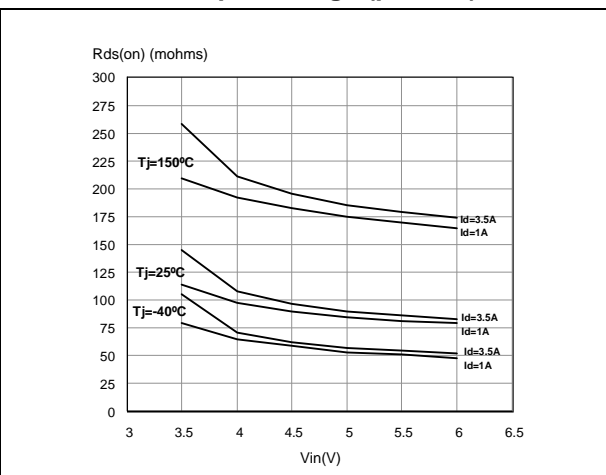

Figure 13. Static drain-source on resistance vs input voltage (part 2/2)

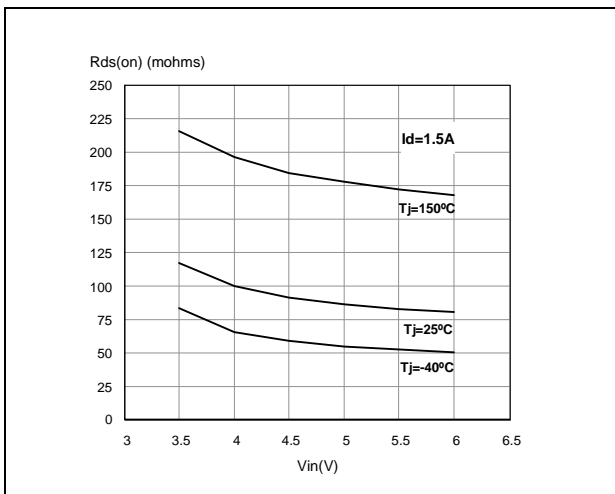

Figure 14. Source-drain diode forward characteristics

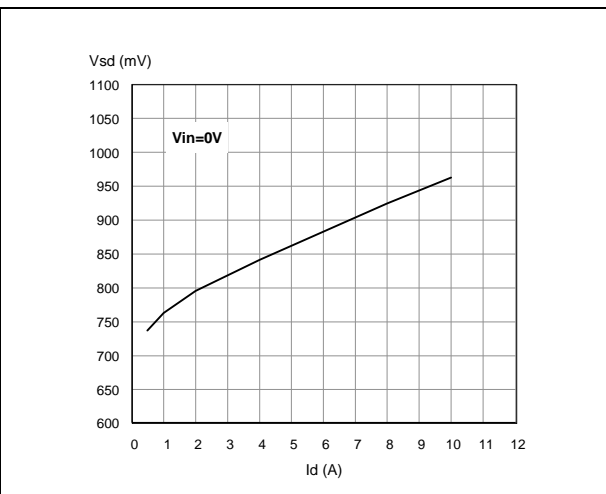

Figure 15. Static drain source on resistance

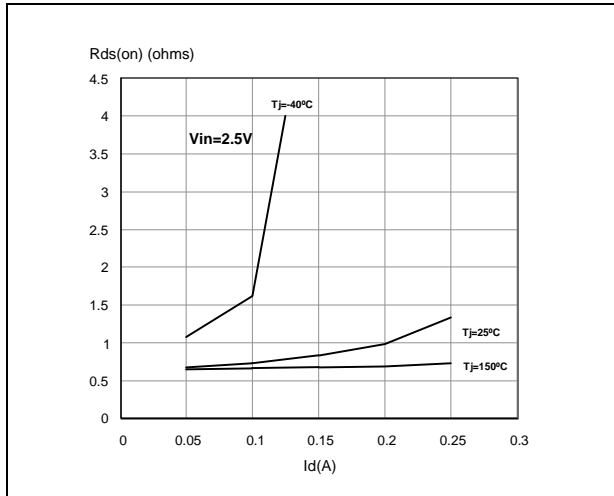

Figure 16. Turn-on current slope (part 1/2)

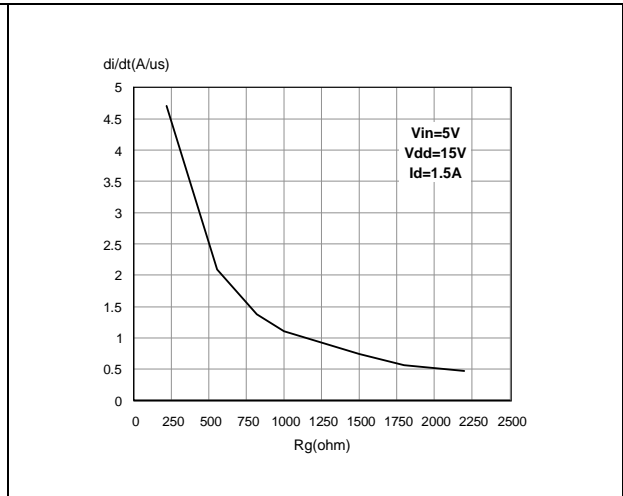

Figure 17. Turn-on current slope (part 2/2)

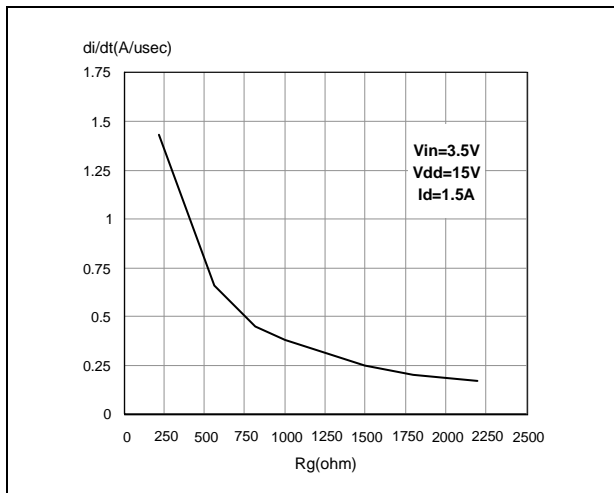

Figure 18. Transfer characteristics

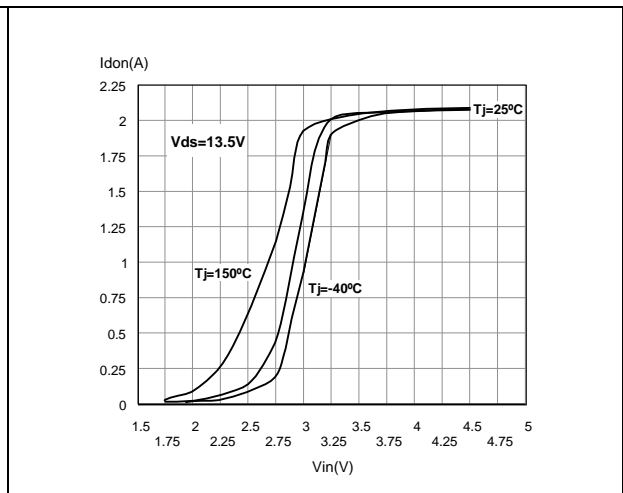

Figure 19. Static drain-source on resistance vs Id

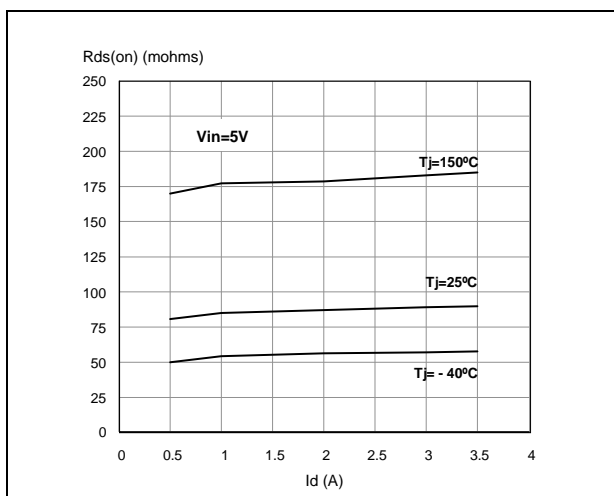

Figure 20. Input voltage vs input charge

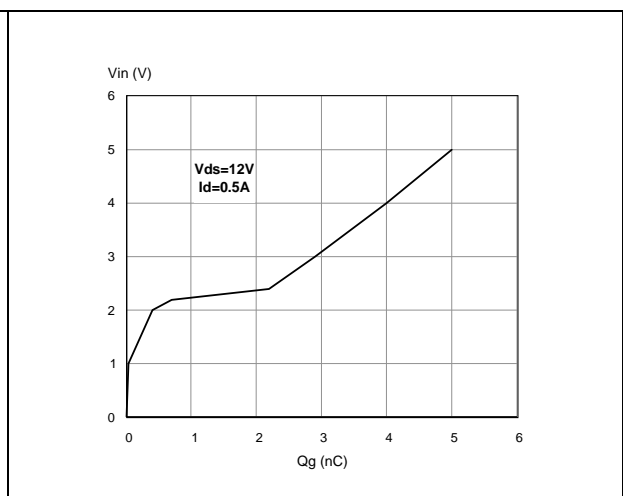

Figure 21. Turn-off drain source voltage slope (part 1/2)

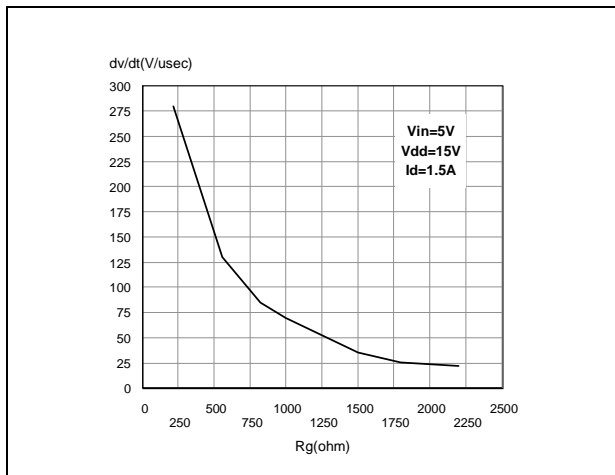

Figure 22. Turn-off drain source voltage slope (part 2/2)

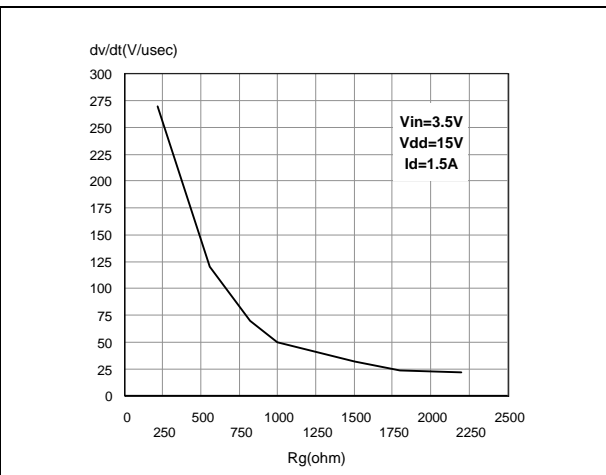

Figure 23. Capacitance variations

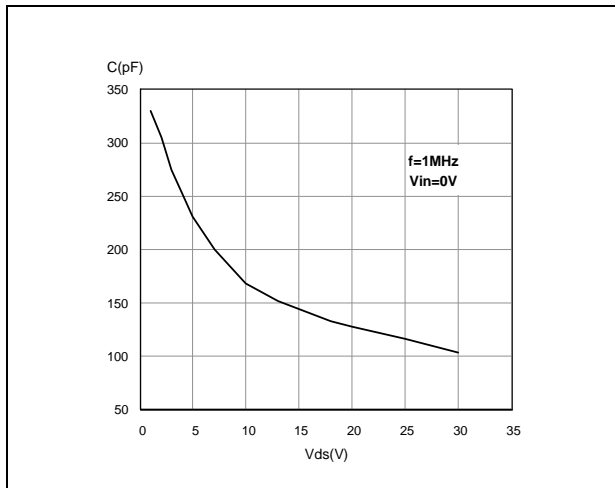

Figure 24. Output characteristics

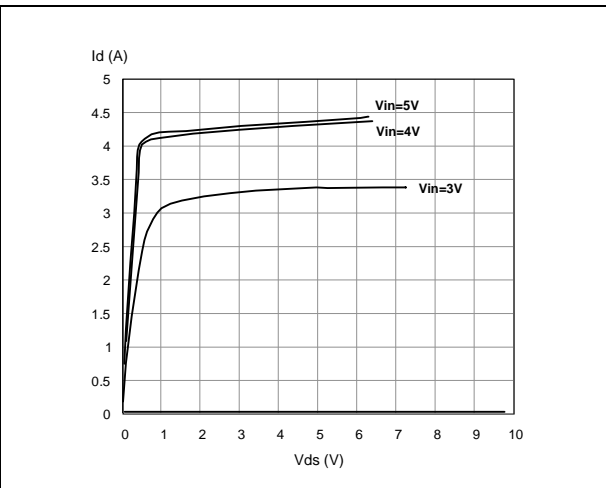

Figure 25. Normalized on resistance vs temperature

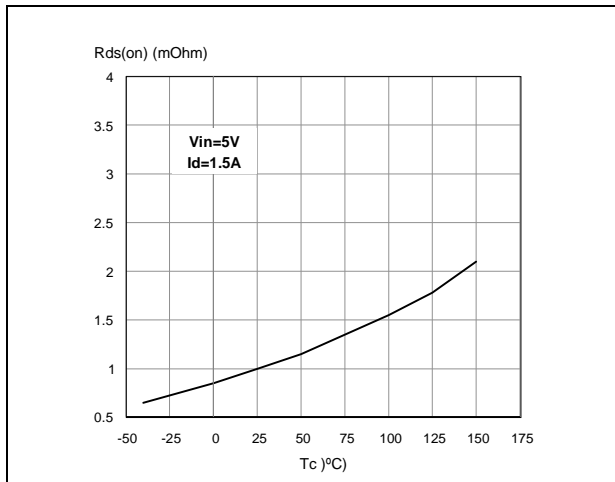
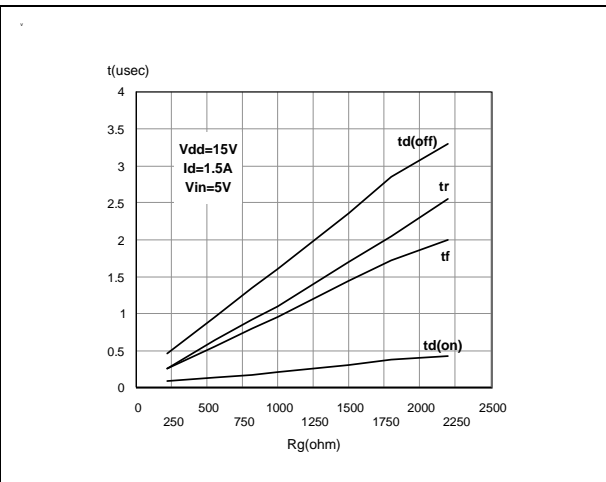
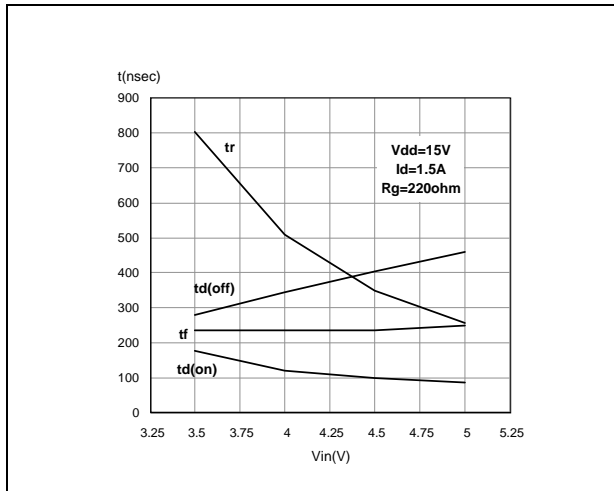

Figure 26. Switching time resistive load (part 1/2)



**Figure 27. Switching time resistive load (part 2/2)**



**Figure 28. Normalized input threshold voltage vs temperature**

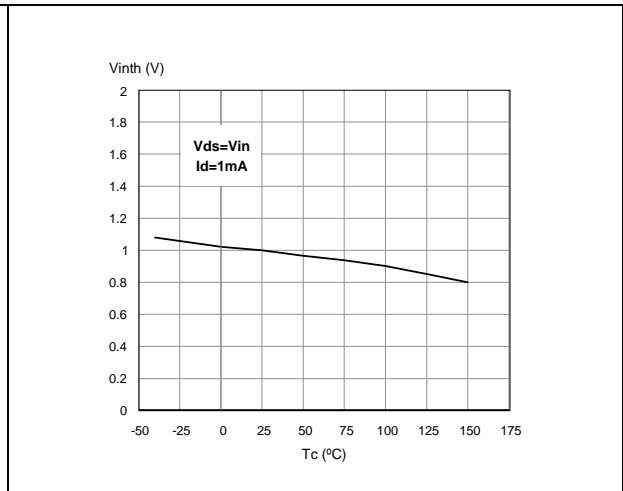

**Figure 29. Normalized current limit vs junction temperature**

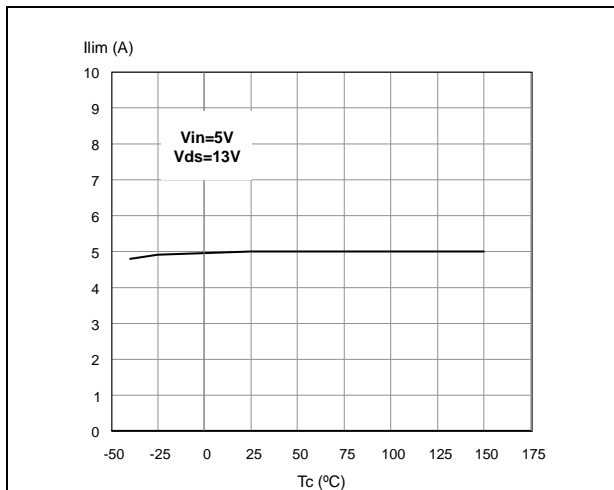

**Figure 30. Step response current limit**

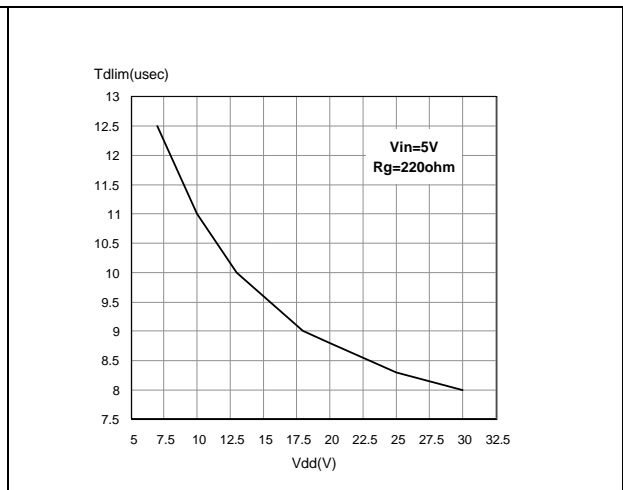

## 4 Package and packing information

In order to meet environmental requirements, ST offers these devices in different grades of ECOPACK® packages, depending on their level of environmental compliance. ECOPACK® specifications, grade definitions and product status are available at: [www.st.com](http://www.st.com).

ECOPACK® is an ST trademark.

### 4.1 SOT-223 mechanical data

Table 5. SOT-223 mechanical data

Symbol	Millimeters		
	Min.	Typ.	Max.
A			1.8
B	0.6	0.7	0.85
B1	2.9	3	3.15
c	0.24	0.26	0.35
D	6.3	6.5	6.7
e		2.3	
e1		4.6	
E	3.3	3.5	3.7
H	6.7	7	7.3
V	10 (max)		
A1	0.02		0.1

Figure 31. SOT-223 package dimensions

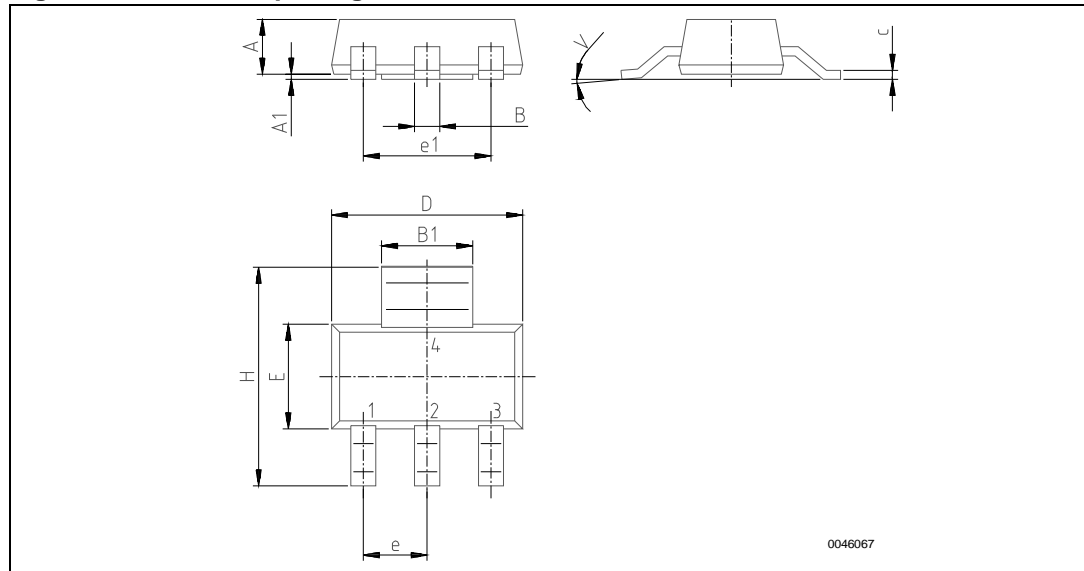



## 4.2 SO-8 mechanical data

Table 6. SO-8 mechanical data

Symbol	Millimeters		
	Min	Typ	Max
A			1.75
a1	0.1		0.25
a2			1.65
a3	0.65		0.85
b	0.35		0.48
A			1.75
A1	0.10		0.25
A2	1.25		
b	0.28		0.48
c	0.17		0.23
D <sup>(1)</sup>	4.80	4.90	5.00
E	5.80	6.00	6.20
E1 <sup>(2)</sup>	3.80	3.90	4.00
e		1.27	
h	0.25		0.50
L	0.40		1.27
L1		1.04	
k	0°		8°
ccc			0.10

1. Dimension "D" does not include mold flash, protrusions or gate burrs. Mold flash, protrusions or gate burrs shall not exceed 0.15 mm in total (both side).
2. Dimension "E1" does not include interlead flash or protrusions. Interlead flash or protrusions shall not exceed 0.25 mm per side.

Figure 32. SO-8 package dimensions

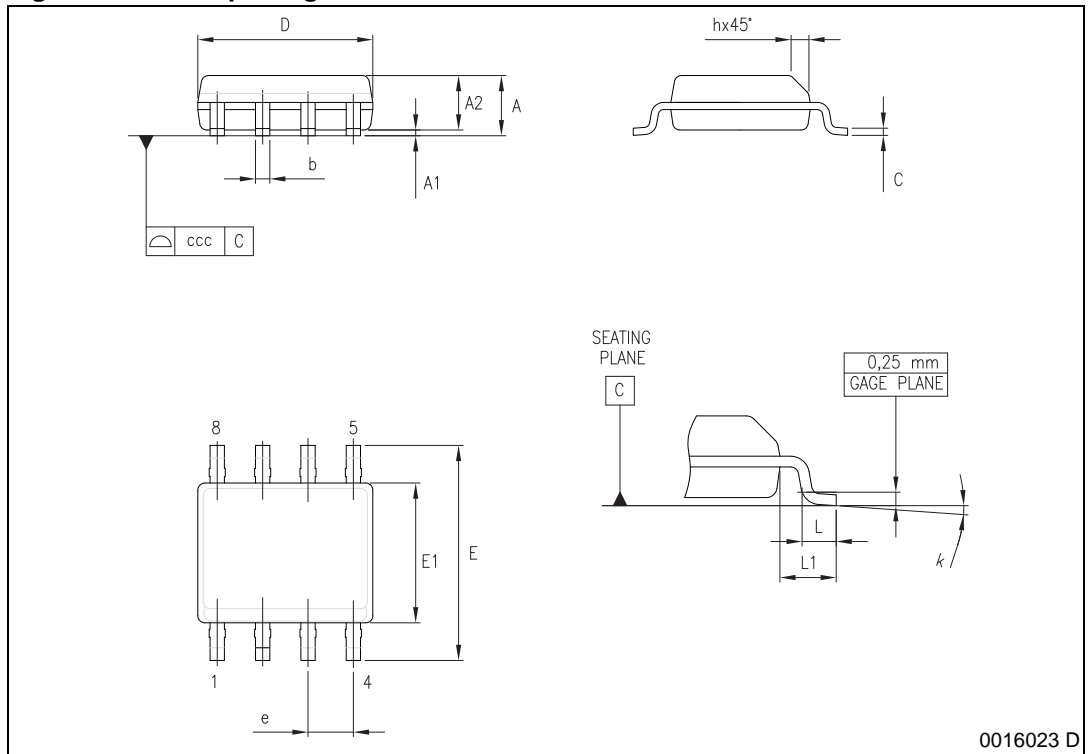

### 4.3 SOT-223 packing information

Figure 33. SOT-223 tape and reel shipment (suffix “TR”)

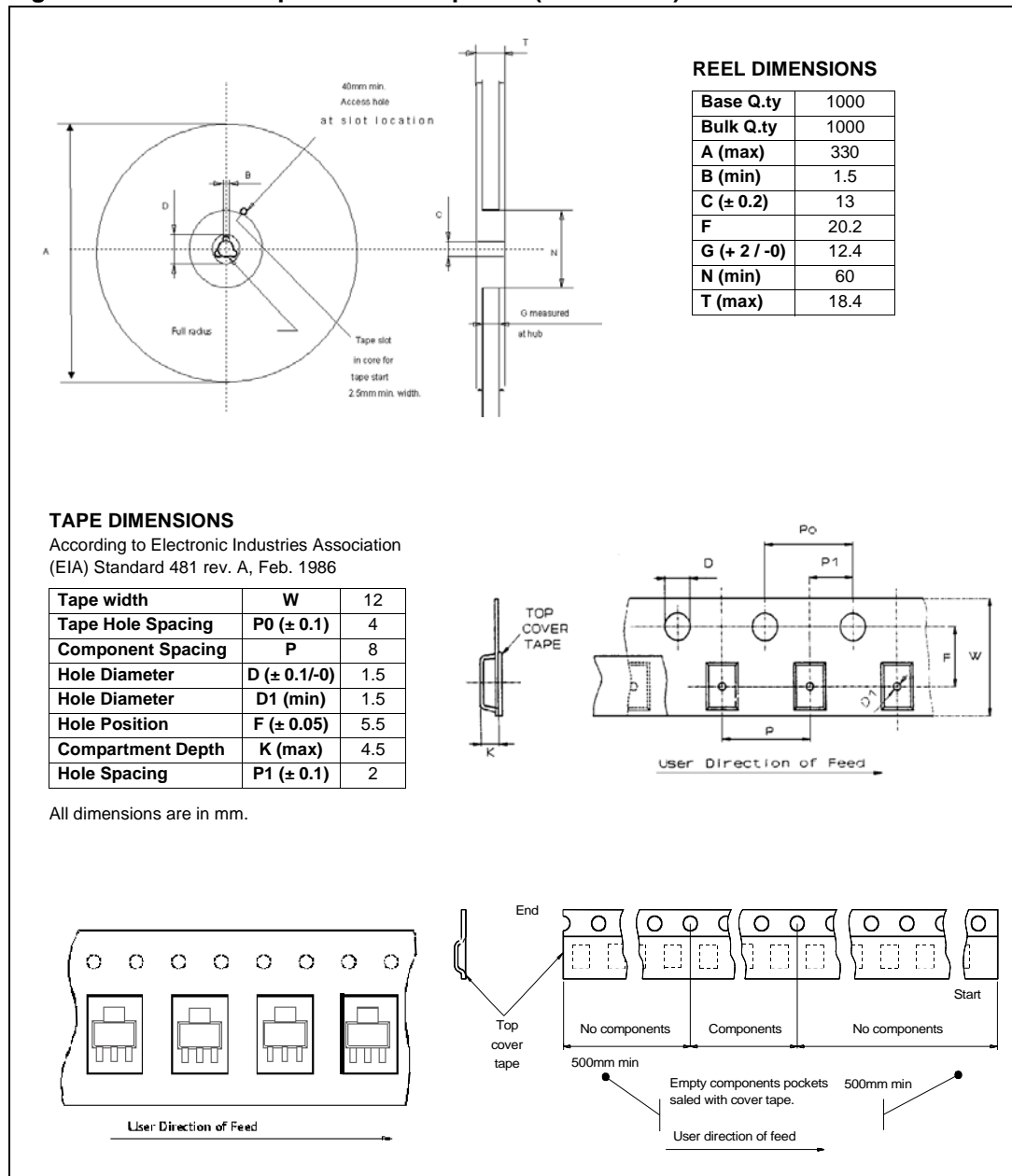

### 4.4 SO-8 packing information

Figure 34. SO-8 tube shipment (no suffix)

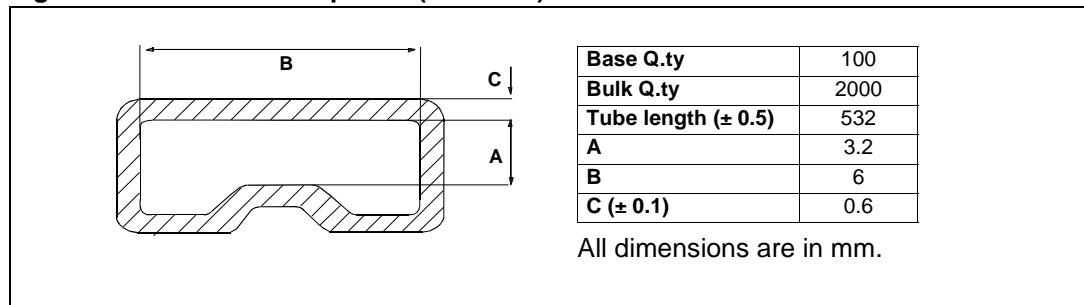
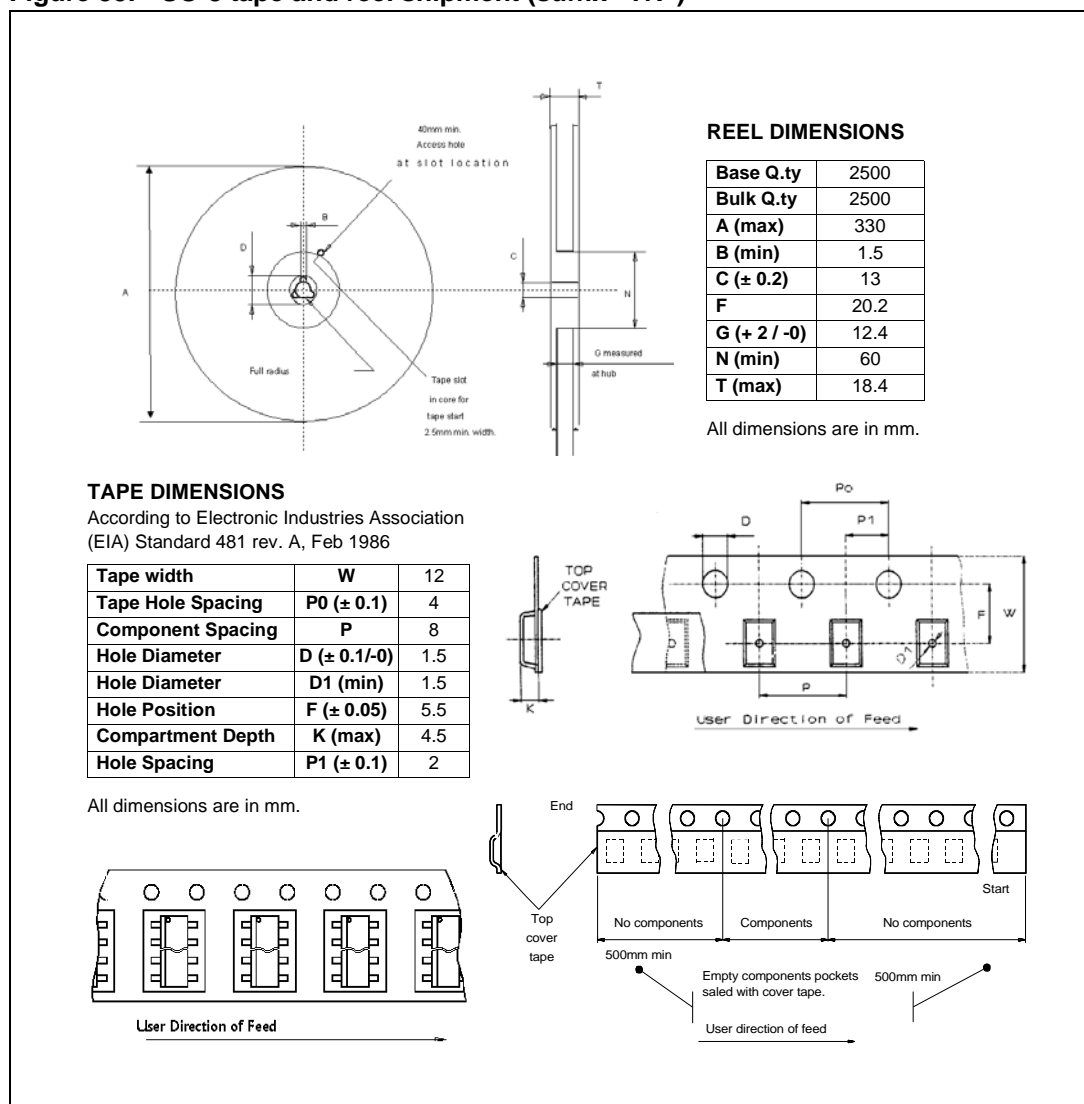

Figure 35. SO-8 tape and reel shipment (suffix "TR")



## 5 Revision history

**Table 7. Document revision history**

Date	Revision	Changes
24-May-2009	1	Initial release.
21-Jul-2009	2	Updated <a href="#">Table 1: Device summary</a> .
29-Sep_2009	3	Removed target specification on cover page.
10-May-2012	4	Updated <a href="#">Table 1: Device summary</a> <a href="#">Table 2: Absolute maximum ratings</a> : – R <sub>IN MIN</sub> : changed unit to $\Omega$ (it was W)
18-Sep-2013	5	Updated Disclaimer.

**Please Read Carefully:**

Information in this document is provided solely in connection with ST products. STMicroelectronics NV and its subsidiaries ("ST") reserve the right to make changes, corrections, modifications or improvements, to this document, and the products and services described herein at any time, without notice.

All ST products are sold pursuant to ST's terms and conditions of sale.

Purchasers are solely responsible for the choice, selection and use of the ST products and services described herein, and ST assumes no liability whatsoever relating to the choice, selection or use of the ST products and services described herein.

No license, express or implied, by estoppel or otherwise, to any intellectual property rights is granted under this document. If any part of this document refers to any third party products or services it shall not be deemed a license grant by ST for the use of such third party products or services, or any intellectual property contained therein or considered as a warranty covering the use in any manner whatsoever of such third party products or services or any intellectual property contained therein.

**UNLESS OTHERWISE SET FORTH IN ST'S TERMS AND CONDITIONS OF SALE ST DISCLAIMS ANY EXPRESS OR IMPLIED WARRANTY WITH RESPECT TO THE USE AND/OR SALE OF ST PRODUCTS INCLUDING WITHOUT LIMITATION IMPLIED WARRANTIES OF MERCHANTABILITY, FITNESS FOR A PARTICULAR PURPOSE (AND THEIR EQUIVALENTS UNDER THE LAWS OF ANY JURISDICTION), OR INFRINGEMENT OF ANY PATENT, COPYRIGHT OR OTHER INTELLECTUAL PROPERTY RIGHT.**

**ST PRODUCTS ARE NOT DESIGNED OR AUTHORIZED FOR USE IN: (A) SAFETY CRITICAL APPLICATIONS SUCH AS LIFE SUPPORTING, ACTIVE IMPLANTED DEVICES OR SYSTEMS WITH PRODUCT FUNCTIONAL SAFETY REQUIREMENTS; (B) AERONAUTIC APPLICATIONS; (C) AUTOMOTIVE APPLICATIONS OR ENVIRONMENTS, AND/OR (D) AEROSPACE APPLICATIONS OR ENVIRONMENTS. WHERE ST PRODUCTS ARE NOT DESIGNED FOR SUCH USE, THE PURCHASER SHALL USE PRODUCTS AT PURCHASER'S SOLE RISK, EVEN IF ST HAS BEEN INFORMED IN WRITING OF SUCH USAGE, UNLESS A PRODUCT IS EXPRESSLY DESIGNATED BY ST AS BEING INTENDED FOR "AUTOMOTIVE, AUTOMOTIVE SAFETY OR MEDICAL" INDUSTRY DOMAINS ACCORDING TO ST PRODUCT DESIGN SPECIFICATIONS. PRODUCTS FORMALLY ESCC, QML OR JAN QUALIFIED ARE DEEMED SUITABLE FOR USE IN AEROSPACE BY THE CORRESPONDING GOVERNMENTAL AGENCY.**

Resale of ST products with provisions different from the statements and/or technical features set forth in this document shall immediately void any warranty granted by ST for the ST product or service described herein and shall not create or extend in any manner whatsoever, any liability of ST.

ST and the ST logo are trademarks or registered trademarks of ST in various countries.

Information in this document supersedes and replaces all information previously supplied.

The ST logo is a registered trademark of STMicroelectronics. All other names are the property of their respective owners.

© 2013 STMicroelectronics - All rights reserved

STMicroelectronics group of companies

Australia - Belgium - Brazil - Canada - China - Czech Republic - Finland - France - Germany - Hong Kong - India - Israel - Italy - Japan - Malaysia - Malta - Morocco - Philippines - Singapore - Spain - Sweden - Switzerland - United Kingdom - United States of America

[www.st.com](http://www.st.com)



## Стандарт Электрон Связь

Мы молодая и активно развивающаяся компания в области поставок электронных компонентов. Мы поставляем электронные компоненты отечественного и импортного производства напрямую от производителей и с крупнейших складов мира.

Благодаря сотрудничеству с мировыми поставщиками мы осуществляем комплексные и плановые поставки широчайшего спектра электронных компонентов.

Собственная эффективная логистика и склад в обеспечивает надежную поставку продукции в точно указанные сроки по всей России.

Мы осуществляем техническую поддержку нашим клиентам и предпродажную проверку качества продукции. На все поставляемые продукты мы предоставляем гарантию .

Осуществляем поставки продукции под контролем ВП МО РФ на предприятия военно-промышленного комплекса России , а также работаем в рамках 275 ФЗ с открытием отдельных счетов в уполномоченном банке. Система менеджмента качества компании соответствует требованиям ГОСТ ISO 9001.

Минимальные сроки поставки, гибкие цены, неограниченный ассортимент и индивидуальный подход к клиентам являются основой для выстраивания долгосрочного и эффективного сотрудничества с предприятиями радиоэлектронной промышленности, предприятиями ВПК и научно-исследовательскими институтами России.

С нами вы становитесь еще успешнее!

### Наши контакты:

**Телефон:** +7 812 627 14 35

**Электронная почта:** [sales@st-electron.ru](mailto:sales@st-electron.ru)

**Адрес:** 198099, Санкт-Петербург,  
Промышленная ул, дом № 19, литера Н,  
помещение 100-Н Офис 331