

Analog Devices Welcomes Hittite Microwave Corporation

NO CONTENT ON THE ATTACHED DOCUMENT HAS CHANGED



THIS PAGE INTENTIONALLY LEFT BLANK

Typical Applications

The HMC465LP5(E) wideband driver is ideal for:

- OC192 LN/MZ Modulator Driver
- Microwave Radio & VSAT
- Test Instrumentation
- Military EW, ECM & C³I

Features

- Gain: 15 dB
- Output Voltage to 10Vpk-pk
- +24 dBm Saturated Output Power
- Supply Voltage: +8V @160 mA
- 50 Ohm Matched Input/Output
- 32 Lead 5x5 mm QFN Package: 25 mm²

Functional Diagram

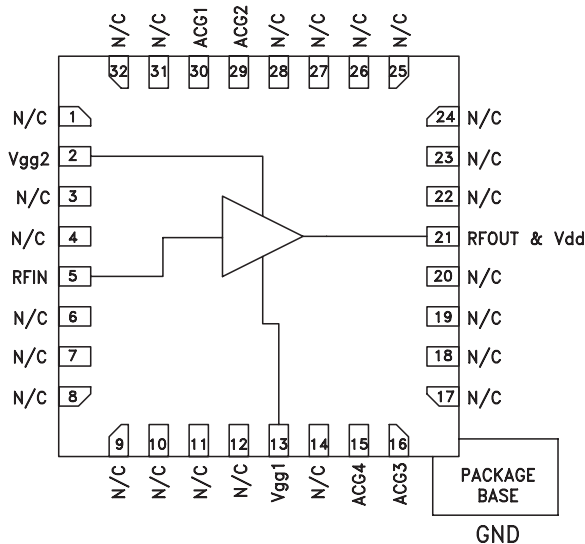

General Description

The HMC465LP5(E) is a GaAs MMIC PHEMT Distributed Driver Amplifier packaged in leadless 5x5 mm surface mount package which operate between DC and 20 GHz. The amplifier provides 15 dB of gain, 3 dB noise figure and +25 dBm of saturated output power while requiring only 160 mA from a +8V supply. Gain flatness is excellent at ±0.5 dB as well as ±4 deg deviation from linear phase from DC - 10 GHz making the HMC465LP5(E) ideal for OC192 fiber optic LN/MZ modulator driver amplifiers as well as test equipment applications. The HMC465LP5(E) amplifiers I/Os are internally matched to 50 Ohms.

Electrical Specifications, $T_A = +25^\circ C$, $V_{dd} = 8V$, $V_{gg2} = 1.5V$, $I_{dd} = 160 mA^*$

Parameter	Min.	Typ.	Max.	Min.	Typ.	Max.	Min.	Typ.	Max.	Units
Frequency Range	DC - 6			6.0 - 12.0			12.0 - 20.0			GHz
Gain	13	16		12	15		9.5	12.5		dB
Gain Flatness		±0.75			±0.25			±1.5		dB
Gain Variation Over Temperature		0.015	0.02		0.020	0.025		0.035	0.045	dB/ °C
Noise Figure		3.0			3.0			4.0		dB
Input Return Loss		20			15			8		dB
Output Return Loss		22			17			12		dB
Output Power for 1 dB Compression (P1dB)	21	24		20	23		16	20		dBm
Saturated Output Power (Psat)		25.5			25			23		dBm
Output Third Order Intercept (IP3)		32			28			24		dBm
Saturated Output Voltage		10			10			8		Vpk-pk
Group Delay Variation		±15			±15					pSec
Supply Current (Idd) (Vdd= 8V, Vgg1= -0.6V Typ.)		160			160			160		mA

* Adjust Vgg1 between -2 to 0V to achieve Idd= 160 mA typical.



Gain & Return Loss

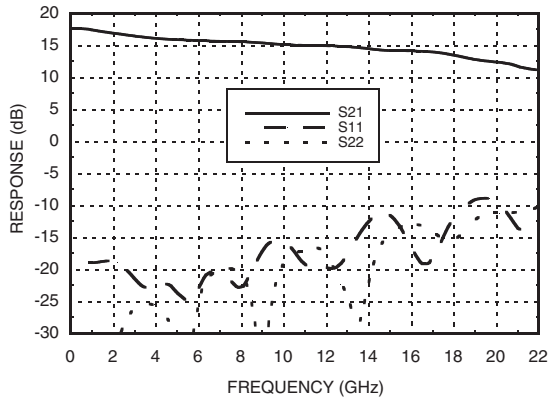

Gain vs. Temperature

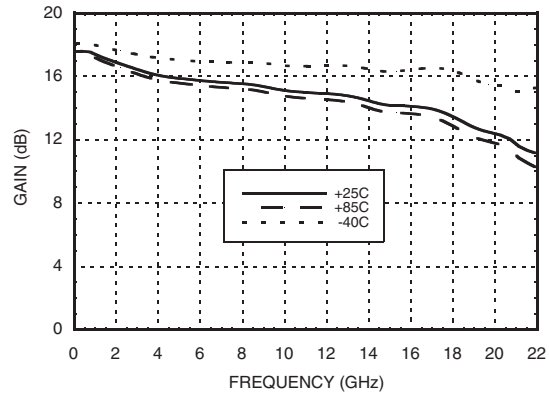

Input Return Loss vs. Temperature

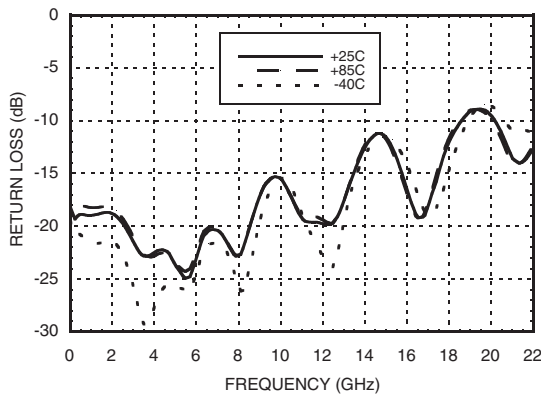

Output Return Loss vs. Temperature

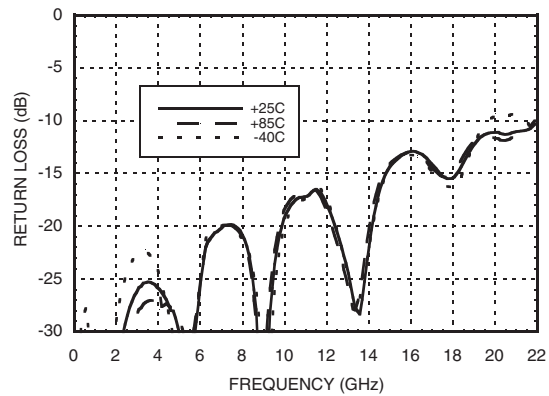

Low Frequency Gain & Return Loss

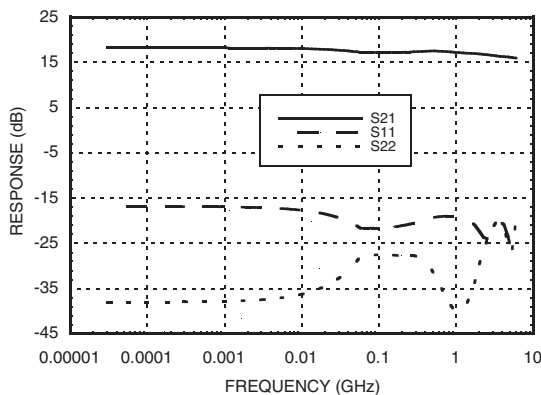

Noise Figure vs. Temperature

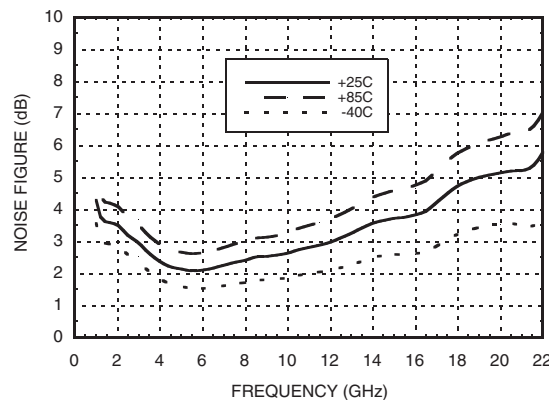



P1dB vs. Temperature

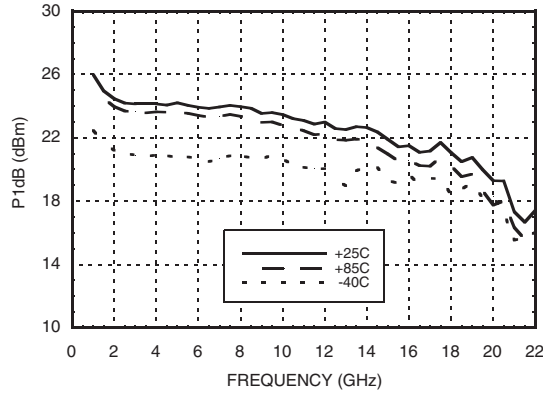

Psat vs. Temperature

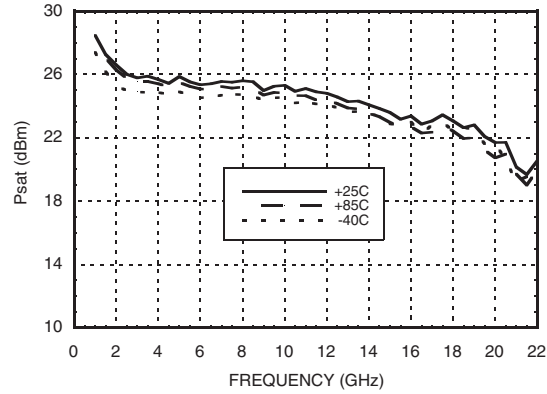

Output IP3 vs. Temperature

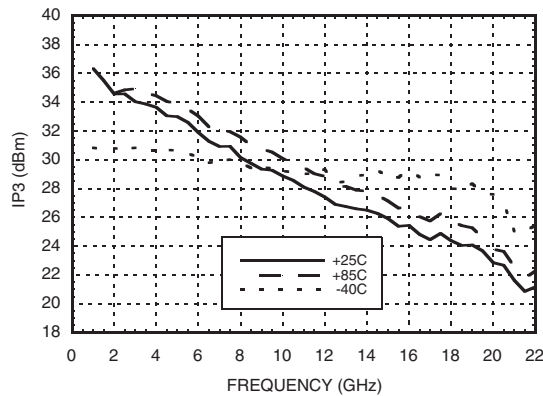

Gain, Power & Output IP3 vs. Supply Voltage @ 10 GHz, I_{dd} = 160mA

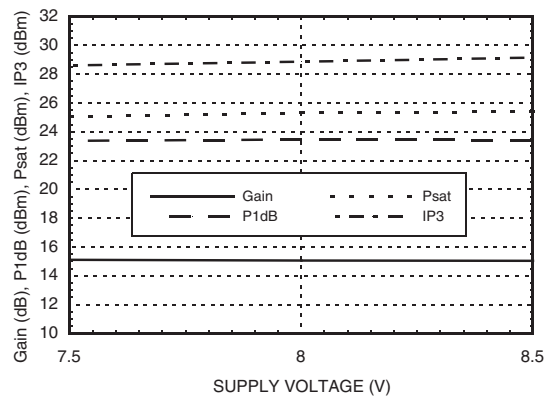

Group Delay

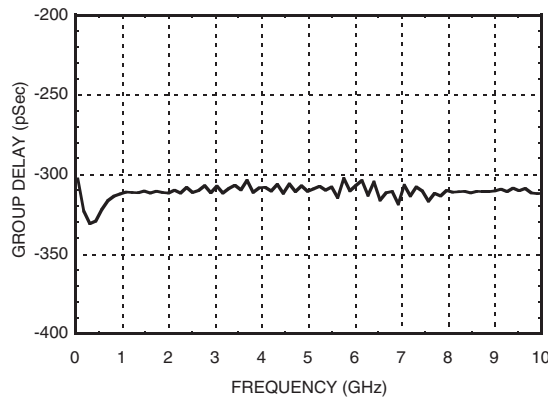

Deviation from Linear Phase

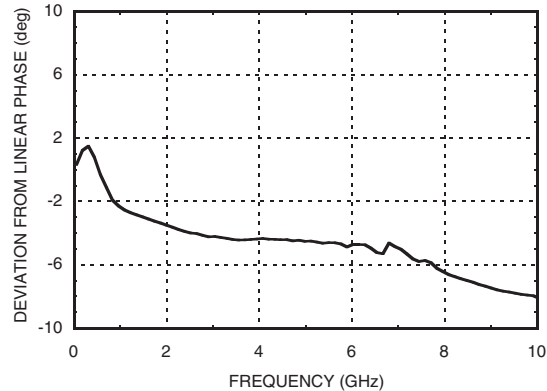

Absolute Maximum Ratings

Drain Bias Voltage (Vdd)	+9 Vdc
Gate Bias Voltage (Vgg1)	-2 to 0 Vdc
Gate Bias Current (Igg1)	+3.2mA
Gate Bias Voltage (Vgg2)	(Vdd -8) Vdc to +3 Vdc
Gate Bias Current (Igg2)	+3.2mA
RF Input Power (RFIN)(Vdd = +8 Vdc)	+23 dBm
Channel Temperature	150 °C
Continuous Pdiss (T = 85 °C) (derate 24 mW/°C above 85 °C)	1.56 W
Thermal Resistance (channel to ground paddle)	41.5 °C/W
Storage Temperature	-65 to +150 °C
Operating Temperature	-40 to +85 °C

Typical Supply Current vs. Vdd

Vdd (V)	Idd (mA)
+7.5	161
+8.0	160
+8.5	159



ELECTROSTATIC SENSITIVE DEVICE
OBSERVE HANDLING PRECAUTIONS

Outline Drawing

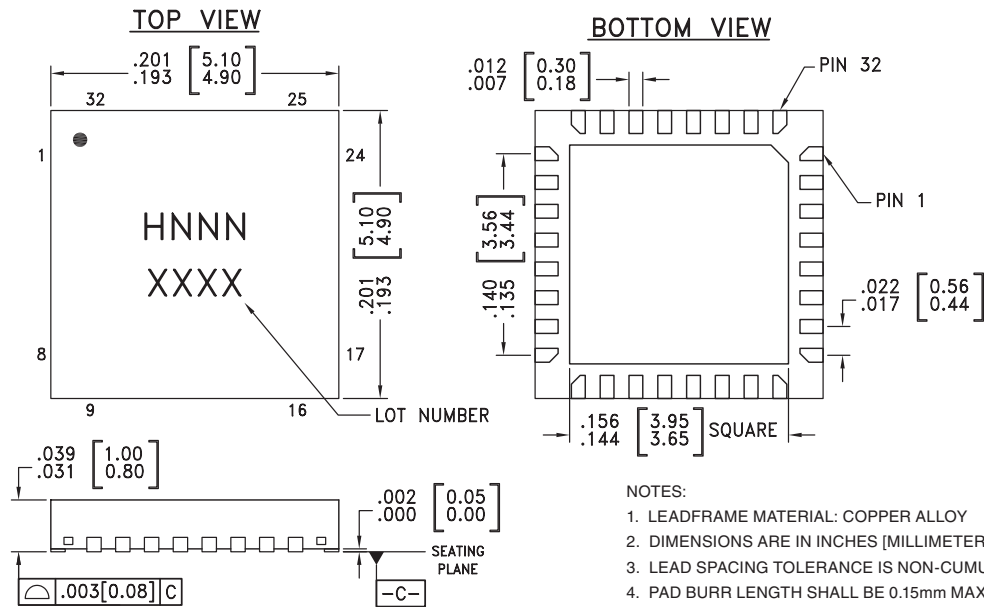

NOTES:

1. LEADFRAME MATERIAL: COPPER ALLOY
2. DIMENSIONS ARE IN INCHES [MILLIMETERS]
3. LEAD SPACING TOLERANCE IS NON-CUMULATIVE.
4. PAD BURR LENGTH SHALL BE 0.15mm MAXIMUM.
PAD BURR HEIGHT SHALL BE 0.05mm MAXIMUM.
5. PACKAGE WARP SHALL NOT EXCEED 0.05mm.
6. ALL GROUND LEADS AND GROUND PADDLE MUST BE SOLDERED TO PCB RF GROUND.
7. REFER TO HITTITE APPLICATION NOTE FOR SUGGESTED LAND PATTERN.

Package Information

Part Number	Package Body Material	Lead Finish	MSL Rating	Package Marking ^[3]
HMC465LP5	Low Stress Injection Molding Plastic	Sn/Pb Solder	MSL1 ^[1]	H465 XXXX
HMC465LP5E	RoHS-compliant Low Stress Injection Molding Plastic	100% matte Sn	MSL1 ^[2]	H465 XXXX

[1] Max peak reflow temperature of 235 °C





[2] Max peak reflow temperature of 260 °C

[3] 4-Digit lot number XXXX

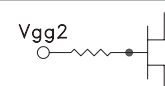

GaAs PHEMT MMIC MODULATOR DRIVER AMPLIFIER, DC - 20 GHz

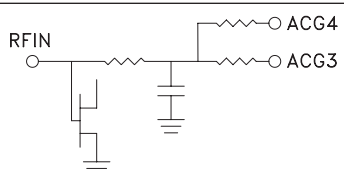
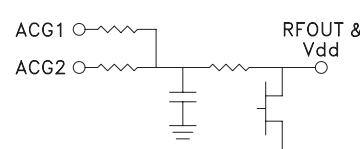
Pin Descriptions

Pin Number	Function	Description	Interface Schematic
1, 3, 4, 6 - 12, 14, 17, 18, 19, 20, 22 - 28, 31, 32	N/C	The pins are not connected internally; however, all data shown herein was measured with these pins connected to RF/DC ground externally.	
2	Vgg2	Gate Control 2 for amplifier. +1.5V should be applied to Vgg2 for nominal operation.	
5	RFIN	This pad is DC coupled and matched to 50 Ohms.	
13	Vgg1	Gate Control 1 for amplifier.	
15	ACG4	Low frequency termination. Attach bypass capacitor per application circuit herein.	
16	ACG3		
21	RFOUT & Vdd	RF output for amplifier. Connect the DC bias (Vdd) network to provide drain current (Idd). See application circuit herein.	
29	ACG2	Low frequency termination. Attach bypass capacitor per application circuit herein.	
30	ACG1		
Ground Paddle	GND	Ground paddle must be connected to RF/DC ground.	

Application Circuit

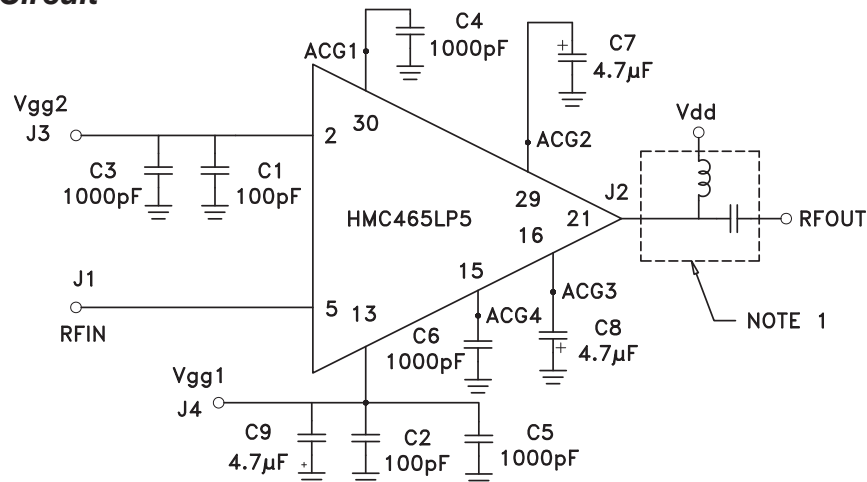

NOTE 1: Drain Bias (Vdd) must be applied through a broadband bias tee or external bias network.



Evaluation PCB

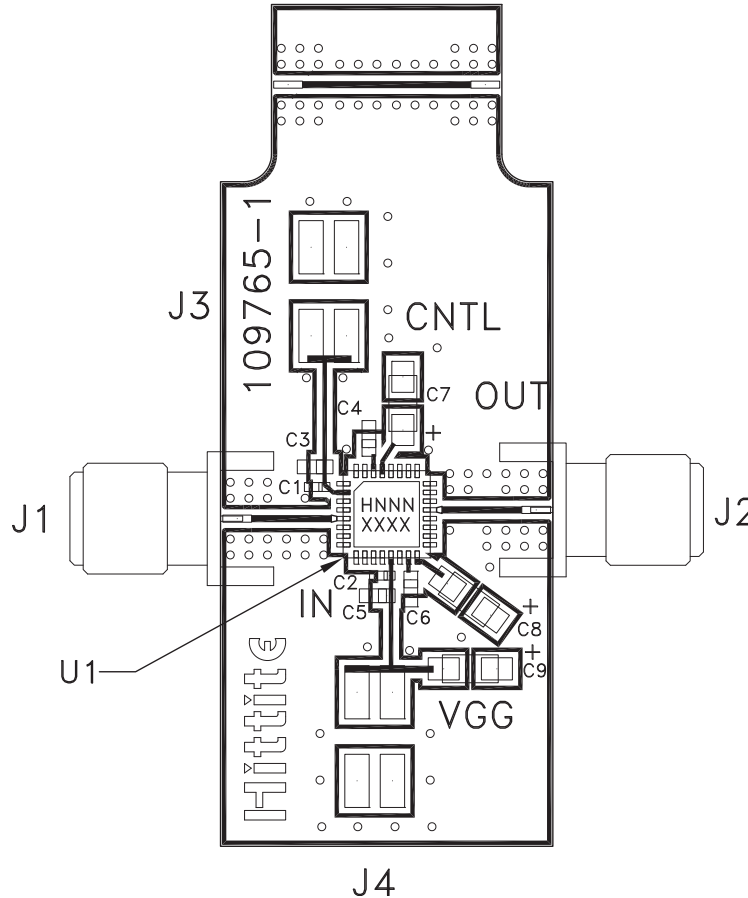

List of Materials for Evaluation PCB 108347 [1]

Item	Description
J1 - J2	SRI K Connector
J3 - J4	2mm Molex Header
C1, C2	100 pF Capacitor, 0402 Pkg.
C3 - C6	1000 pF Capacitor, 0603 Pkg.
C7 - C9	4.7 μF Capacitor, Tantalum
U1	HMC465LP5 / HMC465LP5E
PCB [2]	109765 Evaluation PCB

[1] Reference this number when ordering complete evaluation PCB

[2] Circuit Board Material: Rogers 4350

The circuit board used in the final application should use RF circuit design techniques. Signal lines should have 50 Ohm impedance while the package ground leads and package bottom should be connected directly to the ground plane similar to that shown. A sufficient number of via holes should be used to connect the top and bottom ground planes. The evaluation board should be mounted to an appropriate heat sink. The evaluation circuit board shown is available from Hittite upon request.



GaAs PHEMT MMIC MODULATOR DRIVER AMPLIFIER, DC - 20 GHz

Device Operation

These devices are susceptible to damage from Electrostatic Discharge. Proper precautions should be observed during handling, assembly and test.

The input to this device should be AC-coupled. To provide the typical 8Vp-p output voltage swing, a 1.2Vp-p AC-coupled input voltage swing is required.

Device Power Up Instructions

1. Ground the device
 2. Set V_{gg} to -2V (no drain current)
 3. Set V_{ctl} to +1V (no drain current)
 4. Set V_{dd} to +5V (no drain current)
 5. Adjust V_{gg} for I_{dd} = 140mA
- V_{gg} may be varied between -1V and 0V to provide the desired eye crossing point percentage (i.e. 50% crosspoint) and a limited cross point control capability.
 - V_{dd} may be increased to +7V if required to achieve greater output voltage swing.
 - V_{ctl} may be adjusted between +2V and +0V to vary the output voltage swing.

Device Power Down Instructions

1. Reverse the sequence identified above in steps 1 through 4.



Notes:



Стандарт Электрон Связь

Мы молодая и активно развивающаяся компания в области поставок электронных компонентов. Мы поставляем электронные компоненты отечественного и импортного производства напрямую от производителей и с крупнейших складов мира.

Благодаря сотрудничеству с мировыми поставщиками мы осуществляем комплексные и плановые поставки широчайшего спектра электронных компонентов.

Собственная эффективная логистика и склад в обеспечивает надежную поставку продукции в точно указанные сроки по всей России.

Мы осуществляем техническую поддержку нашим клиентам и предпродажную проверку качества продукции. На все поставляемые продукты мы предоставляем гарантию .

Осуществляем поставки продукции под контролем ВП МО РФ на предприятия военно-промышленного комплекса России , а также работаем в рамках 275 ФЗ с открытием отдельных счетов в уполномоченном банке. Система менеджмента качества компании соответствует требованиям ГОСТ ISO 9001.

Минимальные сроки поставки, гибкие цены, неограниченный ассортимент и индивидуальный подход к клиентам являются основой для выстраивания долгосрочного и эффективного сотрудничества с предприятиями радиоэлектронной промышленности, предприятиями ВПК и научно-исследовательскими институтами России.

С нами вы становитесь еще успешнее!

Наши контакты:

Телефон: +7 812 627 14 35

Электронная почта: sales@st-electron.ru

Адрес: 198099, Санкт-Петербург,
Промышленная ул, дом № 19, литера Н,
помещение 100-Н Офис 331