

# REAL TIME CLOCK MODULE WITH 32.768kHz TCXO

AB-RTCMK-32.768kHz

Moisture Sensitivity Level: MSL=1



RoHS  
Compliant

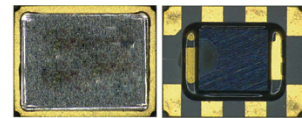

3.2 x 2.5 x 1.0 mm

## FEATURES:

- Ultra low profile, 3.2 x 2.5 x 1.0 mm, Seam sealed SMT package
- Exceptional Frequency Stability over temperature;  $\pm 5.0$  ppm max. over  $-40^{\circ}\text{C}$  to  $+85^{\circ}\text{C}$
- Operating Voltage;  $+1.30\text{V}$  to  $+5.50\text{V}$
- $4.0\mu\text{A}$  max. current at no load
- I2C Communication
- Clock function : Hour/ Min / Sec
- Leap year automatic distinction calendar function till 2099
- Alarm interruption function for day, date, hour and minute settings
- A constant cycle timer interruption function : 244.14us to 255 min
- Time update interruption function : Min / Sec
- Clock output function : 32.768kHz / 1024Hz / 32Hz / 1Hz

## APPLICATIONS:

- Smart cards
- Wireless sensors and tags
- Medical electronics
- Utility meters
- Data loggers
- Appliances
- Handsets
- Consumer electronics

## STANDARD SPECIFICATIONS:

Parameters	Minimum	Typical	Maximum	Units	Notes
Nominal Frequency (f0)		32.768		kHz	
Frequency Tolerance (df/f0)	-3.0		+3.0	ppm	Initial + 2 times reflow $T_a = +25 \pm 2^{\circ}\text{C}$
Frequency Stability vs Temp. (df/f0)	-5.0		+5.0	ppm	$T_a = -40$ to $+85^{\circ}\text{C}$
Frequency Stability vs Voltage (df/dV)	-1.0		+1.0	ppm/V	$T_a = +25^{\circ}\text{C}$ $V_{DD} = 2.0$ to $5.5\text{V}$
Frequency Aging Rate (dfag)	-3.0		+3.0	ppm	$T_a = +25^{\circ}\text{C}$ , first year
Start Up Time (Tst)			1.0	sec	$T_a = +25^{\circ}\text{C}$ $V_{DD} = 1.3\text{V}$
			3.0	sec	$T_a = -40$ to $+85^{\circ}\text{C}$ $V_{DD} = 1.3$ to $5.5\text{V}$
Power Supply Current 1 ( $I_{DD1}$ )		0.6	2.0	$\mu\text{A}$	SCL=SDA=/INT= $V_{DD}$ CLKOUT= $V_{SS}$ , $V_{DD} = 3\text{V}$
Power Supply Current 2 ( $I_{DD2}$ )		1.5	4.0	$\mu\text{A}$	SCL=SDA=/INT= $V_{DD}$ CLKOUT= $V_{DD}$ , $V_{DD} = 3\text{V}$ , CL <sub>OUT</sub> =0pF
Input Leak Current ( $I_{LK}$ )	-0.5		+0.5	$\mu\text{A}$	CLKOE,SCL,SDA $V_{IN} = V_{DD}$ or $V_{SS}$
Output Leak Current ( $I_{OZ}$ )	-0.5		+0.5	$\mu\text{A}$	CLKOUT,/INT,SDA $V_{OUT} = V_{DD}$ or $V_{SS}$
"H" Input Voltage ( $V_{IH}$ )	$0.8 \times V_{DD}$		5.5	V	CLKOE,SCL,SDA
"L" Input Voltage ( $V_{IL}$ )	0.0		$0.2 \times V_{DD}$	V	CLKOE,SCL,SDA
"H" Output Voltage ( $V_{OH}$ )	2.2		3.0	V	CLKOUT, $V_{DD} = 3.0\text{V}$ , $I_{OH} = -1\text{mA}$
"L" Output Voltage	$V_{OL1}$	0.0	0.8	V	CLKOUT, $V_{DD} = 3.0\text{V}$ , $I_{OL} = 1\text{mA}$
	$V_{OL2}$	0.0	0.4	V	/INT, $V_{DD} = 3.0\text{V}$ , $I_{OL} = 1\text{mA}$
	$V_{OL3}$	0.0	0.4	V	SDA, $V_{DD} \geq 2.0\text{V}$ , $I_{OL} = 3\text{mA}$
Low Voltage Detection Voltage ( $V_{DET}$ )	1.3	1.4	1.5	V	

For detail data sheet, please contact [tech-support@abracon.com](mailto:tech-support@abracon.com)

ABRACON IS  
ISO 9001 : 2008  
CERTIFIED



Visit [www.abracon.com](http://www.abracon.com) for Terms & Conditions of Sale **Revised: 09.30.12**  
30332 Esperanza, Rancho Santa Margarita, California 92688  
tel 949-546-8000 | fax 949-546-8001 | [www.abracon.com](http://www.abracon.com)

# REAL TIME CLOCK MODULE WITH 32.768kHz TCXO

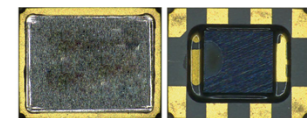

3.2 x 2.5 x 1.0 mm

AB-RTCMK-32.768kHz



RoHS  
Compliant

## AC ELECTRICAL CHARACTERISTICS

Parameters	Minimum	Typical	Maximum	Units	Notes
SCL Clock Frequency ( $f_{SCL}$ )			400	kHz	
START Condition Setup Time ( $t_{SU,STA}$ )	0.6			sec	
START Condition Hold Time ( $t_{HD,STA}$ )	0.6			sec	
Data Input Setup Time ( $t_{SU,DAT}$ )	100			nsec	
Data Input Hold Time ( $t_{HD,DAT}$ )	0		900	nsec	
STOP Condition Setup Time ( $t_{SU,STO}$ )	0.6			sec	
Bus Idle Time Between START and STOP Condition ( $t_{BUF}$ )	1.3			sec	
SCL Low Time ( $t_{LOW}$ )	1.3			sec	
SCL High Time ( $t_{HIGH}$ )	0.6			sec	
SCL, SDA Rise Time ( $t_r$ )			0.3	sec	20% to 80%
SCL, SDA Fall Time ( $t_f$ )			0.3	sec	80% to 20%
Allowable Spike Time on Bus ( $t_{SP}$ )			50	nsec	

## TIMING CHART

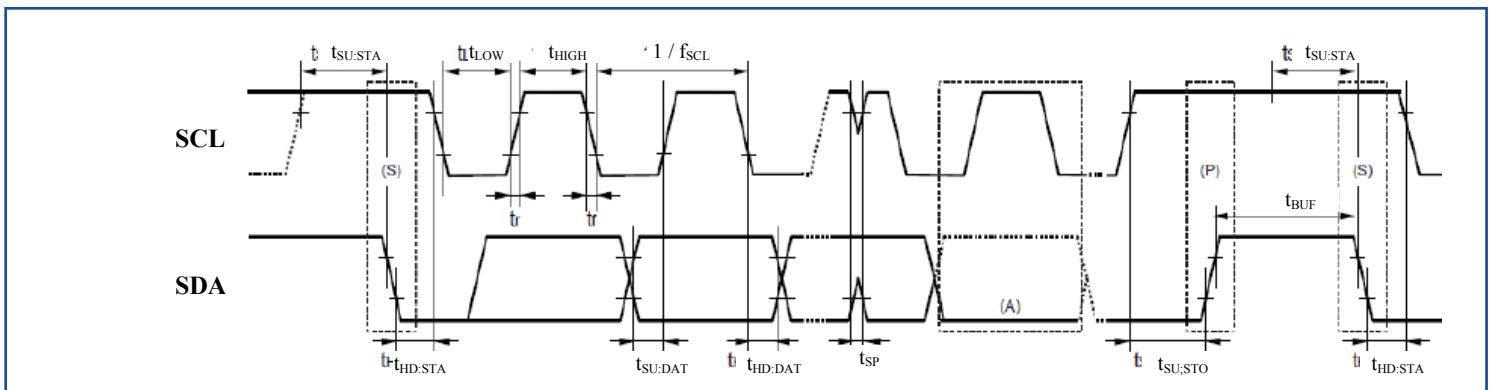

## PART IDENTIFICATION:

AB - RTCMK - 32.768 kHz -

Packaging
Blank: Bulk
T: 1000pcs/reel
T3*: 3000pcs/reel

\*3000pcs/reel: standard reel quantity

ABRACON IS  
ISO 9001 : 2008  
CERTIFIED



**ABRACON**  
CORPORATION

Visit [www.abracon.com](http://www.abracon.com) for Terms & Conditions of Sale **Revised: 09.30.12**  
30332 Esperanza, Rancho Santa Margarita, California 92688  
tel 949-546-8000 | fax 949-546-8001 | [www.abracon.com](http://www.abracon.com)

# REAL TIME CLOCK MODULE WITH 32.768kHz TCXO

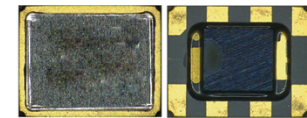

3.2 x 2.5 x 1.0 mm

AB-RTCMK-32.768kHz



RoHS  
Compliant

## FUNCTION:

Pin No.	Pin Name	I/O	Function
1	CLKOE	Input	This is an input pin used to control the output mode of the CLKOUT pin. When this pin's level is high, the CLKOUT pin is in output mode. When it is low, the CLKOUT pin is "Hi-Z" (High Impedance).
2	/INT	Output	This pin is used to output alarm signals, timer signals, timer update signals, and other signals. This pin is an open drain pin.
3	N.C.		This pin is open.
4	VSS		This pin is connected to ground.
5	CLKOUT	Output	This pin outputs a 32.768kHz signal. This is the C-MOS output pin with output control provided via the CLKOE pin.
6	SCL	Input	This is the serial clock input for I <sup>2</sup> C BUS communications.
7	SDA	I/O	This is the serial data input/output for I <sup>2</sup> C BUS communications. This pin's signal is used for input and output of address, data, and ACK bits, synchronized with the serial clock used for I <sup>2</sup> C communication. This pin is an N-ch open drain pin during output.
8	VDD		This pin is connected to a positive power supply.

## BLOCK DIAGRAM:

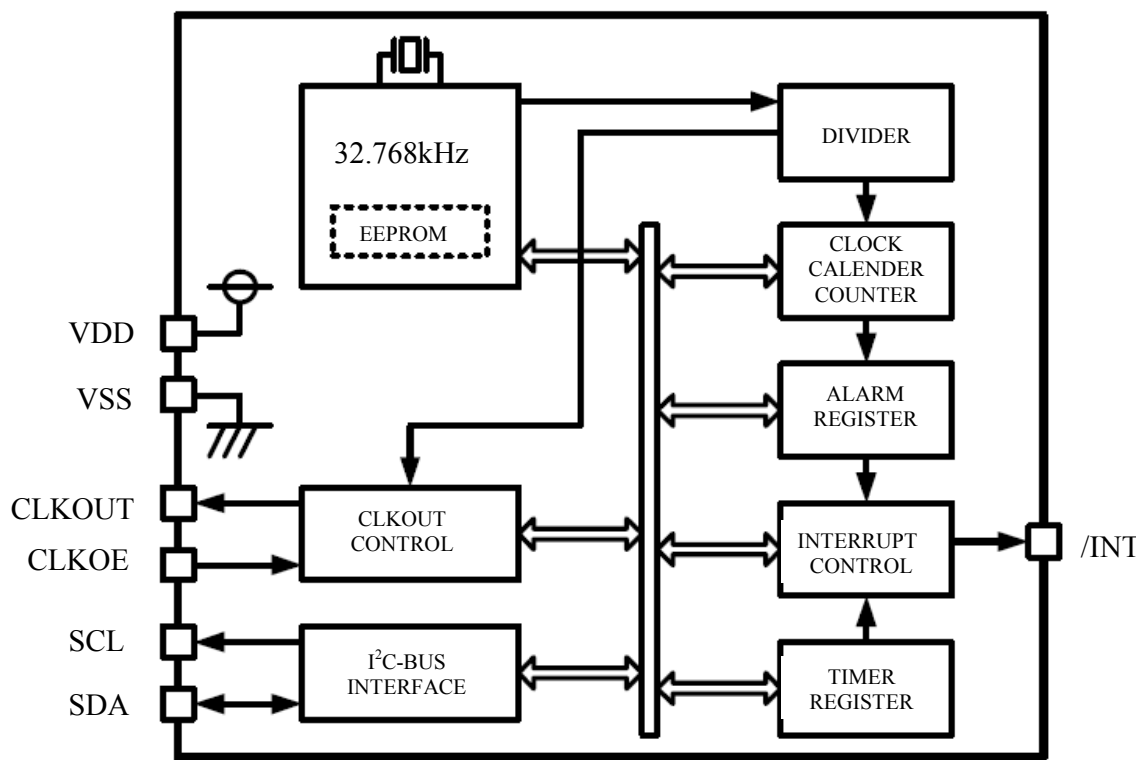

# REAL TIME CLOCK MODULE WITH 32.768kHz TCXO

AB-RTCMK-32.768kHz



RoHS  
Compliant

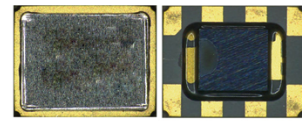

3.2 x 2.5 x 1.0 mm

## MARKING:

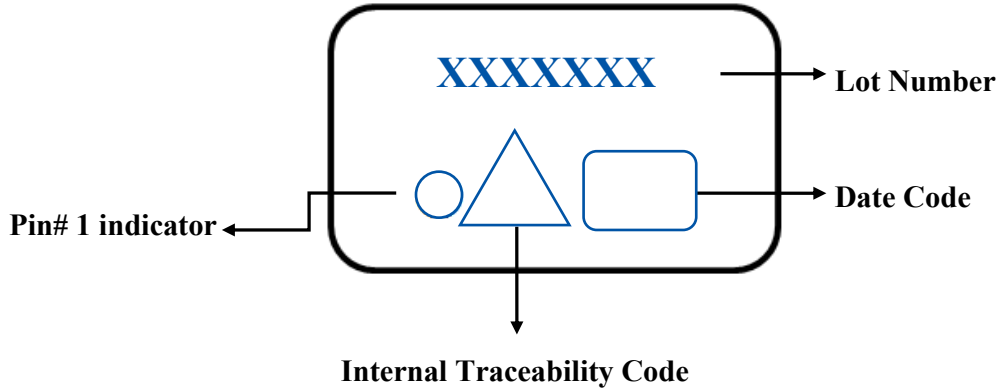

## OUTLINE DRAWING:

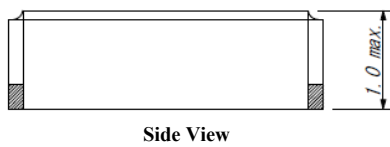
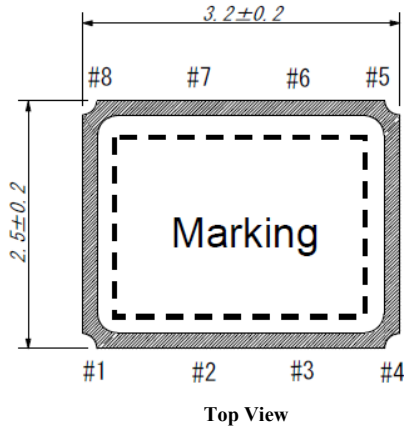

### PIN / Function

#1 : CLKOE	#5 : CLKOUT
#2 : /INT	#6 : SCL
#3 : N.C.	#7 : SDA
#4 : VSS	#8 : VDD

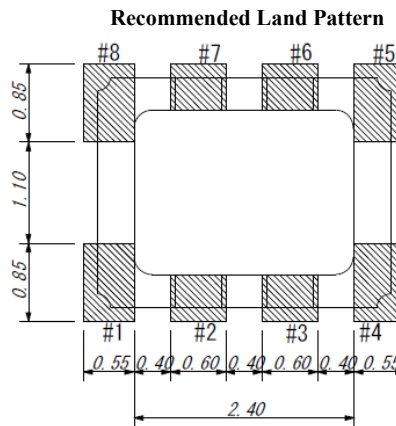
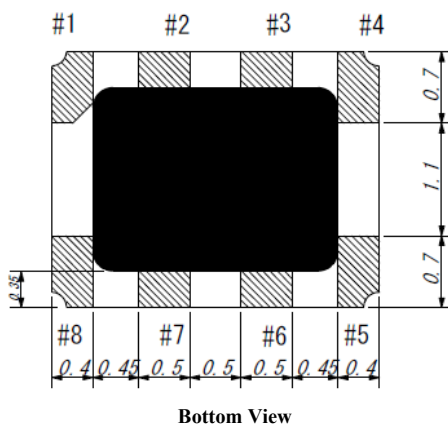

Dimension : mm

# REAL TIME CLOCK MODULE WITH 32.768kHz TCXO

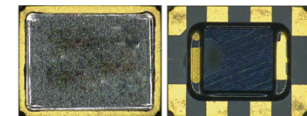

3.2 x 2.5 x 1.0 mm

AB-RTCMK-32.768kHz



RoHS  
Compliant

## TAPE & REEL:

T: 1000pcs/reel

T3: 3000pcs/reel (standard reel quantity)

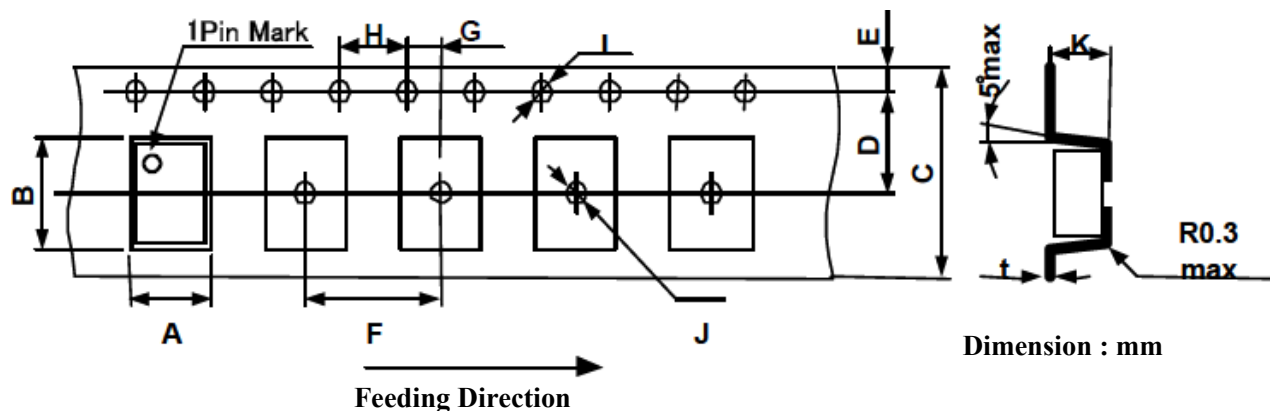

A	B	C	D	E	F
2.80 ± 0.1	3.50 ± 0.1	8.00 ± 0.3	3.50 ± 0.05	1.75 ± 0.1	4.00 ± 0.1
G	H	I	J	K	T
2.00 ± 0.05	4.00 ± 0.1	ø1.5 +1.0/-0	ø 1.5 +1.0/-0	1.10 ± 0.1	0.25 ± 0.05

### Reel Dimensions

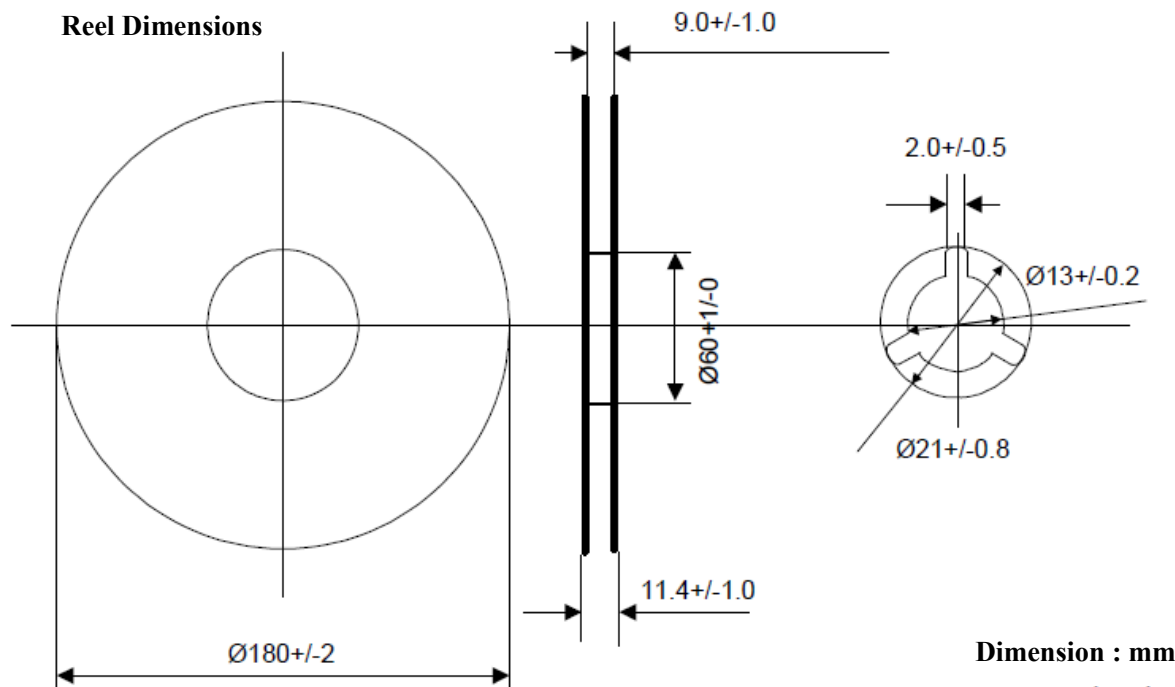

For detail data sheet, please contact [tech-support@abracon.com](mailto:tech-support@abracon.com)

**ATTENTION:** Abracon Corporation's products are COTS – Commercial-Off-The-Shelf products; suitable for Commercial, Industrial and, where designated, Automotive Applications. Abracon's products are not specifically designed for Military, Aviation, Aerospace, Life-dependant Medical applications or any application requiring high reliability where component failure could result in loss of life and/or property. For applications requiring high reliability and/or presenting an extreme operating environment, written consent and authorization from Abracon Corporation is required. Please contact Abracon Corporation for more information.

ABRACON IS  
ISO 9001 : 2008  
CERTIFIED



Visit [www.abracon.com](http://www.abracon.com) for Terms & Conditions of Sale

Revised: 09.30.12

30332 Esperanza, Rancho Santa Margarita, California 92688

tel 949-546-8000 | fax 949-546-8001 | [www.abracon.com](http://www.abracon.com)



## Стандарт Электрон Связь

Мы молодая и активно развивающаяся компания в области поставок электронных компонентов. Мы поставляем электронные компоненты отечественного и импортного производства напрямую от производителей и с крупнейших складов мира.

Благодаря сотрудничеству с мировыми поставщиками мы осуществляем комплексные и плановые поставки широчайшего спектра электронных компонентов.

Собственная эффективная логистика и склад в обеспечивает надежную поставку продукции в точно указанные сроки по всей России.

Мы осуществляем техническую поддержку нашим клиентам и предпродажную проверку качества продукции. На все поставляемые продукты мы предоставляем гарантию .

Осуществляем поставки продукции под контролем ВП МО РФ на предприятия военно-промышленного комплекса России , а также работаем в рамках 275 ФЗ с открытием отдельных счетов в уполномоченном банке. Система менеджмента качества компании соответствует требованиям ГОСТ ISO 9001.

Минимальные сроки поставки, гибкие цены, неограниченный ассортимент и индивидуальный подход к клиентам являются основой для выстраивания долгосрочного и эффективного сотрудничества с предприятиями радиоэлектронной промышленности, предприятиями ВПК и научно-исследовательскими институтами России.

С нами вы становитесь еще успешнее!

### Наши контакты:

**Телефон:** +7 812 627 14 35

**Электронная почта:** [sales@st-electron.ru](mailto:sales@st-electron.ru)

**Адрес:** 198099, Санкт-Петербург,  
Промышленная ул, дом № 19, литера Н,  
помещение 100-Н Офис 331