



Aluminum electrolytic capacitors

Single-ended capacitors

Series/Type: 6 (% ™ (' , ™

The following products presented in this data sheet are being withdrawn.

Ordering Code	Substitute Product	Date of Withdrawal	Deadline Last Orders	Last Shipments
see following page		2013-10-18	2014-01-18	2014-04-18

For further information please contact your nearest EPCOS sales office, which will also support you in selecting a suitable substitute. The addresses of our worldwide sales network are presented at www.epcos.com/sales.

© EPCOS AG 2015. Reproduction, publication and dissemination of this publication, enclosures hereto and the information contained therein without EPCOS' prior express consent is prohibited.

EPCOS AG is a TDK Group Company.

General-purpose grade capacitors

Applications

- General-purpose applications in the entertainment industry
- Semi-professional to professional application range
- For filtering, coupling and pulse circuits

Features

- Compact dimensions
- High CV product, i.e. very compact
- RoHS-compatible

Construction

- Radial leads
- Charge-discharge proof, polar
- Aluminum case with insulating sleeve
- Minus pole marking on the insulating sleeve
- Case with safety vent from diameter 6.3 mm

Delivery mode

Terminal configurations and packing:

- Bulk
- Taped, Ammo pack
- Cut
- Kinked
- PAPR (protection against polarity reversal):
crimped leads, J leads, bent leads

Refer to chapter "Single-ended capacitors – Taping, packing and lead configurations" for further details.

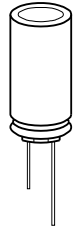

Specifications and characteristics in brief

Series	B41821		B43821							
Rated voltage V_R	6.3 ... 100 V DC		160 ... 450 V DC							
Surge voltage V_S	1.15 · V_R		1.1 · V_R							
Rated capacitance C_R	0.1 ... 10000 μ F		0.47 ... 680 μ F							
Capacitance tolerance	$\pm 20\% \triangleq M$		$\pm 20\% \triangleq M$							
Dissipation factor $\tan \delta$ (20 °C, 120 Hz)	For capacitance higher than 1000 μ F add 0.02 for every increase of 1000 μ F.									
	V_R (V DC)	6.3	10	16	25	35	50	63	100	160 ... 450
	$\tan \delta$ (max.)	0.28	0.24	0.20	0.16	0.14	0.12	0.12	0.10	0.20
Leakage current I_{leak} (20 °C, 5 min)	$I_{leak} = 0.01 \mu A \cdot \left(\frac{C_R}{\mu F} \cdot \frac{V_R}{V} \right)$ or 3 μA , whichever is greater				$I_{leak} = 0.03 \mu A \cdot \left(\frac{C_R}{\mu F} \cdot \frac{V_R}{V} \right) + 15 \mu A$					
Self-inductance ESL	Diameter (mm)	≤ 6.3	8 ... 12.5		16		18		20 ... 25	
	ESL (nH)	15	20		26		34		40	
Useful life 85 °C; V_R ; $I_{AC,R}$ 40 °C; V_R ; 1.3 · $I_{AC,R}$ 40 °C; V_R ; 1.6 · $I_{AC,R}$	> 2000 h				> 3000 h					
	> 100000 h				–					
	–				> 100000 h					
Requirements	$\Delta C/C \leq \pm 45\%$ of initial value									
	$\tan \delta \leq 3$ times initial specified limit									
	$I_{leak} \leq$ initial specified limit									
Voltage endurance test 85 °C; V_R	2000 h				2000 h					
	Post test requirements									
Vibration resistance test	$\Delta C/C \leq \pm 30\%$ of initial value									
	$\tan \delta \leq 2$ times initial specified limit									
	$I_{leak} \leq$ initial specified limit									
IEC climatic category	To IEC 60068-2-6, test Fc: Frequency range 10 Hz ... 2 kHz, displacement amplitude 1.5 mm, acceleration max. 20 g, duration 3 × 2 h. Capacitor rigidly clamped by the aluminum case.									
	To IEC 60068-1: $V_R \leq 250$ V: 40/085/56 (–40 °C/+85 °C/56 days damp heat test) $V_R \geq 350$ V: 25/085/56 (–25 °C/+85 °C/56 days damp heat test)									
	Sectional specification IEC 60384-4									



B41821, B43821

Standard series – 85 °C

Dimensional drawings

With stand-off rubber seal

Diameters (mm):

6.3, 10, 12.5, 16, 18, 22, 25

With flat rubber seal

Diameters (mm):

5, 8, 20



Safety vent for diameter ≥ 6.3 mm.

Dimensions and weights

Dimensions (mm)				Approx. weight
d +0.5	l	a ± 0.5	b	g
5	11 +1.0	2.0	0.50 ± 0.05	0.5
6.3	11 +1.0	2.5	0.50 ± 0.05	0.7
8	11.5 +1.5	3.5	0.60 ± 0.05	1.0
10	12.5 +1.0	5.0	0.60 ± 0.05	1.6
10	16 +1.0	5.0	0.60 ± 0.05	1.9
10	20 +2.0	5.0	0.60 ± 0.05	2.6
12.5	20 +2.0	5.0	0.60 ± 0.05	3.6
12.5	25 +2.0	5.0	0.60 ± 0.05	4.5
16	20 +2.0	7.5	0.80 ± 0.05	5.5
16	25 +2.0	7.5	0.80 ± 0.05	7.5
16	31.5 +2.0	7.5	0.80 ± 0.05	7.8
18	31.5 +2.0	7.5	0.80 ± 0.1	11.0
18	35 +2.0	7.5	0.80 ± 0.1	13.0
18	40 +2.0	7.5	0.80 ± 0.1	16.0
20	30 +2.0	10.0	1.0 ± 0.1	14.0
20	35 +2.0	10.0	1.0 ± 0.1	18.0
20	40 +2.0	10.0	1.0 ± 0.1	20.0
22	40 +2.0	10.0	1.0 ± 0.1	23.0
25	40 +2.0	12.5	1.0 ± 0.1	25.0

Overview of available types – B41821

Other voltage and capacitance ratings are available upon request.

V_R (V DC)	6.3	10	16	25	35
	Case dimensions $d \times l$ (mm)				
C_R (μ F)					
33					5 × 11
47				5 × 11	5 × 11
68				5 × 11	6.3 × 11
100		5 × 11	5 × 11	6.3 × 11	6.3 × 11
220		6.3 × 11	6.3 × 11	8 × 11.5	8 × 11.5
330	6.3 × 11	8 × 11.5	8 × 11.5	8 × 11.5 10 × 12.5	10 × 12.5
470	8 × 11.5	8 × 11.5	8 × 11.5	10 × 12.5	10 × 16
680	8 × 11.5	10 × 12.5	10 × 12.5	10 × 16	10 × 20
1000	10 × 12.5	10 × 12.5	10 × 16	10 × 20	12.5 × 20
1500	10 × 16	10 × 20	10 × 20	12.5 × 20	16 × 20
2200	10 × 20	10 × 20	12.5 × 20	12.5 × 25	16 × 25
3300	10 × 20	12.5 × 25	12.5 × 25 16 × 25	16 × 25	16 × 31.5
4700	12.5 × 25	16 × 20	16 × 25	16 × 31.5	18 × 35
6800		16 × 25	16 × 31.5	18 × 35	18 × 40
10000		18 × 31.5	18 × 35	20 × 40	

B41821
Standard series – 85 °C

V_R (V DC)	50	63	100
	Case dimensions $d \times l$ (mm)		
C_R (μ F)			
0.10			5 × 11
0.22			5 × 11
0.33			5 × 11
0.47			5 × 11
0.68			5 × 11
1.0			5 × 11
2.2			5 × 11
3.3			5 × 11
4.7			5 × 11
10	5 × 11	5 × 11	6.3 × 11
22	5 × 11	5 × 11	8 × 11.5
33	6.3 × 11	6.3 × 11	8 × 11.5 10 × 12.5
47	6.3 × 11	6.3 × 11	10 × 12.5
68	6.3 × 11	8 × 11.5	10 × 16
100	8 × 11.5	8 × 11.5	10 × 20
220	10 × 12.5	10 × 16	12.5 × 25
330	10 × 16	10 × 20	16 × 25
470	10 × 20	12.5 × 20	16 × 31.5
680	12.5 × 20	16 × 20	18 × 40
1000	12.5 × 25	16 × 25	18 × 40 20 × 40
1500	16 × 25	18 × 31.5	
2200	16 × 31.5	18 × 35	
3300	18 × 35	20 × 40	
4700	20 × 40	25 × 40	

Overview of available types – B43821

Other voltage and capacitance ratings are available upon request.

V_R (V DC)	160	200	250	350	400	450
	Case dimensions $d \times l$ (mm)					
C_R (μ F)						
0.47			6.3 × 11	6.3 × 11		
0.68			6.3 × 11	6.3 × 11		
1.0	6.3 × 11	6.3 × 11	6.3 × 11	6.3 × 11		
2.2	6.3 × 11	6.3 × 11	6.3 × 11	6.3 × 11 8 × 11.5	8 × 11.5	8 × 11.5
3.3	6.3 × 11	6.3 × 11	6.3 × 11	8 × 11.5	8 × 11.5	10 × 12.5
4.7	6.3 × 11	6.3 × 11	8 × 11.5	8 × 11.5	10 × 12.5	10 × 12.5
10	8 × 11.5	8 × 11.5	10 × 12.5	10 × 16	10 × 20	10 × 20
22	10 × 12.5 10 × 16	10 × 16	10 × 20	12.5 × 20	12.5 × 25	12.5 × 25
33	10 × 16 10 × 20	10 × 20	12.5 × 20	12.5 × 25	16 × 20	16 × 25
47	10 × 20 12.5 × 20	12.5 × 20	12.5 × 25	16 × 25	16 × 25	16 × 31.5
68	12.5 × 20	12.5 × 25	16 × 25	16 × 31.5	18 × 31.5	18 × 35
100	12.5 × 25 16 × 25	16 × 25	16 × 31.5	18 × 35	18 × 40	20 × 40
220	16 × 31.5 18 × 31.5	18 × 31.5	18 × 40			
330	18 × 35	20 × 35	22 × 40			
470	20 × 40	22 × 40				
680	25 × 40					

B41821
Standard series – 85 °C
Technical data and ordering codes – B41821

C_R 120 Hz 20 °C μF	Case dimensions $d \times l$ mm	ESR_{max} 120 Hz 20 °C Ω	$I_{\text{AC,R}}$ 120 Hz 85 °C mA	Ordering code (composition see below)
$V_R = 6.3 \text{ V DC}$				
330	6.3 × 11	1.4	280	B41821A2337M***
470	8 × 11.5	1.0	380	B41821B2477M***
680	8 × 11.5	0.68	400	B41821F2687M***
1000	10 × 12.5	0.46	650	B41821A2108M***
1500	10 × 16	0.31	750	B41821A2158M***
2200	10 × 20	0.23	1000	B41821A2228M***
3300	10 × 20	0.16	1190	B41821A2338M***
4700	12.5 × 25	0.12	1600	B41821A2478M***
$V_R = 10 \text{ V DC}$				
100	5 × 11	4.0	145	B41821A3107M***
220	6.3 × 11	1.8	240	B41821A3227M***
330	8 × 11.5	1.2	290	B41821B3337M***
470	8 × 11.5	0.85	400	B41821A3477M***
680	10 × 12.5	0.59	460	B41821A3687M***
1000	10 × 12.5	0.40	650	B41821A3108M***
1500	10 × 20	0.27	740	B41821A3158M***
2200	10 × 20	0.20	1100	B41821A3228M***
3300	12.5 × 25	0.14	1550	B41821A3338M***
4700	16 × 20	0.11	1700	B41821A3478M***
6800	16 × 25	0.08	2250	B41821F3688M***
10000	18 × 31.5	0.07	2600	B41821F3109M***
$V_R = 16 \text{ V DC}$				
100	5 × 11	3.3	180	B41821A4107M***
220	6.3 × 11	1.5	260	B41821F4227M***
330	8 × 11.5	1.0	370	B41821B4337M***
470	8 × 11.5	0.71	440	B41821F4477M***

Composition of ordering code

*** = Version

- 000 = for standard leads, bulk
- 001 = for kinked leads, bulk (from $d \times l = 10 \times 20 \text{ mm}$ to $18 \times 40 \text{ mm}$)
- 002 = for cut leads, bulk (from $d \times l = 10 \times 12.5 \text{ mm}$ to $22 \times 40 \text{ mm}$)
- 003 = for crimped leads, blister (from $d \times l = 16 \times 20 \text{ mm}$ to $20 \times 40 \text{ mm}$)
- 004 = for J leads, blister (from $d \times l = 10 \times 12.5 \text{ mm}$ to $18 \times 35 \text{ mm}$)
- 006 = for taped leads, Ammo pack, lead spacing $F = 3.5 \text{ mm}$ (for $d = 8 \text{ mm}$)
- 007 = for taped leads, Ammo pack, lead spacing $F = 2.5 \text{ mm}$ (from $d = 5 \text{ mm}$ to 6.3 mm)
- 008 = for taped leads, Ammo pack, lead spacing $F = 5.0 \text{ mm}$ (from $d \times l = 5 \times 11 \text{ mm}$ to $12.5 \times 25 \text{ mm}$)
- 009 = for taped leads, Ammo pack, lead spacing $F = 7.5 \text{ mm}$ (for $d \times l = 16 \times 20 \dots 16 \times 31.5 \text{ mm}$ and $18 \times 25 \dots 18 \times 31.5 \text{ mm}$)
- 012 = for bent 90° leads, blister (for $\varnothing 16$ and 18 mm)

B41821
Standard series – 85 °C
Technical data and ordering codes – B41821

C_R 120 Hz 20 °C μF	Case dimensions $d \times l$ mm	ESR_{max} 120 Hz 20 °C Ω	$I_{\text{AC,R}}$ 120 Hz 85 °C mA	Ordering code (composition see below)
$V_R = 16 \text{ V DC}$				
680	10 × 12.5	0.49	600	B41821F4687M***
1000	10 × 16	0.33	790	B41821A4108M***
1500	10 × 20	0.22	950	B41821F4158M***
2200	12.5 × 20	0.17	1300	B41821K4228M***
3300	12.5 × 25	0.12	1700	B41821F4338M***
3300	16 × 25	0.12	1800	B41821A4338M***
4700	16 × 25	0.09	2100	B41821A4478M***
6800	16 × 31.5	0.07	2300	B41821F4688M***
10000	18 × 35	0.06	2750	B41821F4109M***
$V_R = 25 \text{ V DC}$				
47	5 × 11	5.6	115	B41821A5476M***
68	5 × 11	3.9	125	B41821F5686M***
100	6.3 × 11	2.7	190	B41821A5107M***
220	8 × 11.5	1.2	330	B41821B5227M***
330	8 × 11.5	0.80	440	B41821F5337M***
330	10 × 12.5	0.80	440	B41821A5337M***
470	10 × 12.5	0.56	550	B41821B5477M***
680	10 × 16	0.39	630	B41821F5687M***
1000	10 × 20	0.27	960	B41821A5108M***
1500	12.5 × 20	0.18	1100	B41821F5158M***
2200	12.5 × 25	0.14	1550	B41821F5228M***
3300	16 × 25	0.10	1980	B41821A5338M***
4700	16 × 31.5	0.08	2450	B41821A5478M***
6800	18 × 35	0.06	2650	B41821F5688M***
10000	20 × 40	0.06	2900	B41821F5109M***

Composition of ordering code

*** = Version

000 = for standard leads, bulk

 001 = for kinked leads, bulk (from $d \times l = 10 \times 20 \text{ mm}$ to $18 \times 40 \text{ mm}$)

 002 = for cut leads, bulk (from $d \times l = 10 \times 12.5 \text{ mm}$ to $22 \times 40 \text{ mm}$)

 003 = for crimped leads, blister (from $d \times l = 16 \times 20 \text{ mm}$ to $20 \times 40 \text{ mm}$)

 004 = for J leads, blister (from $d \times l = 10 \times 12.5 \text{ mm}$ to $18 \times 35 \text{ mm}$)

 006 = for taped leads, Ammo pack, lead spacing $F = 3.5 \text{ mm}$ (for $d = 8 \text{ mm}$)

 007 = for taped leads, Ammo pack, lead spacing $F = 2.5 \text{ mm}$ (from $d = 5 \text{ mm}$ to 6.3 mm)

 008 = for taped leads, Ammo pack, lead spacing $F = 5.0 \text{ mm}$ (from $d \times l = 5 \times 11 \text{ mm}$ to $12.5 \times 25 \text{ mm}$)

 009 = for taped leads, Ammo pack, lead spacing $F = 7.5 \text{ mm}$ (for $d \times l = 16 \times 20 \dots 16 \times 31.5 \text{ mm}$ and $18 \times 25 \dots 18 \times 31.5 \text{ mm}$)

 012 = for bent 90° leads, blister (for $\varnothing 16$ and 18 mm)

B41821
Standard series – 85 °C
Technical data and ordering codes – B41821

C_R 120 Hz 20 °C μF	Case dimensions $d \times l$ mm	ESR_{max} 120 Hz 20 °C Ω	$I_{\text{AC,R}}$ 120 Hz 85 °C mA	Ordering code (composition see below)
$V_R = 35 \text{ V DC}$				
33	5 × 11	7.0	105	B41821A7336M***
47	5 × 11	4.9	130	B41821A7476M***
68	6.3 × 11	3.4	160	B41821A7686M***
100	6.3 × 11	2.3	210	B41821F7107M***
220	8 × 11.5	1.1	385	B41821F7227M***
330	10 × 12.5	0.70	490	B41821A7337M***
470	10 × 16	0.49	650	B41821A7477M***
680	10 × 20	0.34	840	B41821A7687M***
1000	12.5 × 20	0.23	1150	B41821K7108M***
1500	16 × 20	0.15	1400	B41821F7158M***
2200	16 × 25	0.12	1800	B41821F7228M***
3300	16 × 31.5	0.09	2100	B41821F7338M***
4700	18 × 35	0.07	2550	B41821F7478M***
6800	18 × 40	0.06	2800	B41821K7688M***
$V_R = 50 \text{ V DC}$				
10	5 × 11	20	60	B41821A6106M***
22	5 × 11	9.0	95	B41821A6226M***
33	6.3 × 11	6.0	110	B41821A6336M***
47	6.3 × 11	4.2	155	B41821A6476M***
68	6.3 × 11	2.9	210	B41821F6686M***
100	8 × 11.5	2.0	260	B41821A6107M***
220	10 × 12.5	0.90	430	B41821A6227M***
330	10 × 16	0.60	590	B41821A6337M***

Composition of ordering code

*** = Version

000 = for standard leads, bulk

 001 = for kinked leads, bulk (from $d \times l = 10 \times 20 \text{ mm}$ to $18 \times 40 \text{ mm}$)

 002 = for cut leads, bulk (from $d \times l = 10 \times 12.5 \text{ mm}$ to $22 \times 40 \text{ mm}$)

 003 = for crimped leads, blister (from $d \times l = 16 \times 20 \text{ mm}$ to $20 \times 40 \text{ mm}$)

 004 = for J leads, blister (from $d \times l = 10 \times 12.5 \text{ mm}$ to $18 \times 35 \text{ mm}$)

 006 = for taped leads, Ammo pack, lead spacing $F = 3.5 \text{ mm}$ (for $d = 8 \text{ mm}$)

 007 = for taped leads, Ammo pack, lead spacing $F = 2.5 \text{ mm}$ (from $d = 5 \text{ mm}$ to 6.3 mm)

 008 = for taped leads, Ammo pack, lead spacing $F = 5.0 \text{ mm}$ (from $d \times l = 5 \times 11 \text{ mm}$ to $12.5 \times 25 \text{ mm}$)

 009 = for taped leads, Ammo pack, lead spacing $F = 7.5 \text{ mm}$ (for $d \times l = 16 \times 20 \dots 16 \times 31.5 \text{ mm}$ and $18 \times 25 \dots 18 \times 31.5 \text{ mm}$)

 012 = for bent 90° leads, blister (for $\varnothing 16$ and 18 mm)

B41821
Standard series – 85 °C
Technical data and ordering codes – B41821

C_R 120 Hz 20 °C μF	Case dimensions $d \times l$ mm	ESR_{max} 120 Hz 20 °C Ω	$I_{\text{AC,R}}$ 120 Hz 85 °C mA	Ordering code (composition see below)
$V_R = 50 \text{ V DC}$				
470	10 × 20	0.42	760	B41821A6477M***
680	12.5 × 20	0.29	1000	B41821F6687M***
1000	12.5 × 25	0.20	1350	B41821F6108M***
1500	16 × 25	0.13	1800	B41821F6158M***
2200	16 × 31.5	0.11	1980	B41821F6228M***
3300	18 × 35	0.08	2500	B41821F6338M***
4700	20 × 40	0.06	2800	B41821K6478M***
$V_R = 63 \text{ V DC}$				
10	5 × 11	20	65	B41821A8106M***
22	5 × 11	9.0	100	B41821F8226M***
33	6.3 × 11	6.0	140	B41821A8336M***
47	6.3 × 11	4.2	170	B41821F8476M***
68	8 × 11.5	2.9	220	B41821F8686M***
100	8 × 11.5	2.0	280	B41821F8107M***
220	10 × 16	0.90	490	B41821A8227M***
330	10 × 20	0.60	710	B41821A8337M***
470	12.5 × 20	0.42	900	B41821F8477M***
680	16 × 20	0.29	1100	B41821F8687M***
1000	16 × 25	0.20	1300	B41821F8108M***
1500	18 × 31.5	0.13	1800	B41821F8158M***
2200	18 × 35	0.11	2300	B41821K8228M***
3300	20 × 40	0.08	2700	B41821A8338M***
4700	25 × 40	0.06	3200	B41821F8478M***

Composition of ordering code

*** = Version

000 = for standard leads, bulk

 001 = for kinked leads, bulk (from $d \times l = 10 \times 20 \text{ mm}$ to $18 \times 40 \text{ mm}$)

 002 = for cut leads, bulk (from $d \times l = 10 \times 12.5 \text{ mm}$ to $22 \times 40 \text{ mm}$)

 003 = for crimped leads, blister (from $d \times l = 16 \times 20 \text{ mm}$ to $20 \times 40 \text{ mm}$)

 004 = for J leads, blister (from $d \times l = 10 \times 12.5 \text{ mm}$ to $18 \times 35 \text{ mm}$)

 006 = for taped leads, Ammo pack, lead spacing $F = 3.5 \text{ mm}$ (for $d = 8 \text{ mm}$)

 007 = for taped leads, Ammo pack, lead spacing $F = 2.5 \text{ mm}$ (from $d = 5 \text{ mm}$ to 6.3 mm)

 008 = for taped leads, Ammo pack, lead spacing $F = 5.0 \text{ mm}$ (from $d \times l = 5 \times 11 \text{ mm}$ to $12.5 \times 25 \text{ mm}$)

 009 = for taped leads, Ammo pack, lead spacing $F = 7.5 \text{ mm}$ (for $d \times l = 16 \times 20 \dots 16 \times 31.5 \text{ mm}$ and $18 \times 25 \dots 18 \times 31.5 \text{ mm}$)

 012 = for bent 90° leads, blister (for $\varnothing 16$ and 18 mm)

B41821
Standard series – 85 °C
Technical data and ordering codes – B41821

C_R 120 Hz 20 °C μF	Case dimensions $d \times l$ mm	ESR_{max} 120 Hz 20 °C Ω	$I_{\text{AC,R}}$ 120 Hz 85 °C mA	Ordering code (composition see below)
$V_R = 100 \text{ V DC}$				
0.1	5 × 11	1658	2	B41821A9104M***
0.22	5 × 11	754	5	B41821A9224M***
0.33	5 × 11	502	7	B41821A9334M***
0.47	5 × 11	353	10	B41821A9474M***
0.68	5 × 11	244	13	B41821A9684M***
1	5 × 11	166	21	B41821A9105M***
2.2	5 × 11	75	30	B41821A9225M***
3.3	5 × 11	50	40	B41821A9335M***
4.7	5 × 11	35	45	B41821A9475M***
10	6.3 × 11	17	75	B41821A9106M***
22	8 × 11.5	7.5	140	B41821B9226M***
33	8 × 11.5	5.0	180	B41821F9336M***
33	10 × 12.5	5.0	190	B41821A9336M***
47	10 × 12.5	3.5	230	B41821B9476M***
68	10 × 16	2.4	280	B41821A9686M***
100	10 × 20	1.7	350	B41821A9107M***
220	12.5 × 25	0.75	620	B41821A9227M***
330	16 × 25	0.50	800	B41821A9337M***
470	16 × 31.5	0.35	1000	B41821A9477M***
680	18 × 40	0.24	1100	B41821F9687M***
1000	18 × 40	0.17	1300	B41821G9108M***
1000	20 × 40	0.17	1400	B41821A9108M***

Composition of ordering code

*** = Version

000 = for standard leads, bulk

 001 = for kinked leads, bulk (from $d \times l = 10 \times 20 \text{ mm}$ to $18 \times 40 \text{ mm}$)

 002 = for cut leads, bulk (from $d \times l = 10 \times 12.5 \text{ mm}$ to $22 \times 40 \text{ mm}$)

 003 = for crimped leads, blister (from $d \times l = 16 \times 20 \text{ mm}$ to $20 \times 40 \text{ mm}$)

 004 = for J leads, blister (from $d \times l = 10 \times 12.5 \text{ mm}$ to $18 \times 35 \text{ mm}$)

 006 = for taped leads, Ammo pack, lead spacing $F = 3.5 \text{ mm}$ (for $d = 8 \text{ mm}$)

 007 = for taped leads, Ammo pack, lead spacing $F = 2.5 \text{ mm}$ (from $d = 5 \text{ mm}$ to 6.3 mm)

 008 = for taped leads, Ammo pack, lead spacing $F = 5.0 \text{ mm}$ (from $d \times l = 5 \times 11 \text{ mm}$ to $12.5 \times 25 \text{ mm}$)

 009 = for taped leads, Ammo pack, lead spacing $F = 7.5 \text{ mm}$ (for $d \times l = 16 \times 20 \dots 16 \times 31.5 \text{ mm}$ and $18 \times 25 \dots 18 \times 31.5 \text{ mm}$)

 012 = for bent 90° leads, blister (for $\varnothing 16$ and 18 mm)

B43821
Standard series – 85 °C
Technical data and ordering codes – B43821

C_R 120 Hz 20 °C μF	Case dimensions $d \times l$ mm	ESR_{max} 120 Hz 20 °C Ω	$I_{\text{AC,R}}$ 120 Hz 85 °C mA	Ordering code (composition see below)
---	---------------------------------------	--	--	--

 $V_R = 160 \text{ V DC}$

1	6.3 × 11	186	22	B43821A1105M***
2.2	6.3 × 11	85	33	B43821A1225M***
3.3	6.3 × 11	56	40	B43821A1335M***
4.7	6.3 × 11	40	50	B43821F1475M***
10	8 × 11.5	18	80	B43821G1106M***
22	10 × 12.5	13	130	B43821F1226M***
22	10 × 16	8.4	155	B43821A1226M***
33	10 × 16	7.5	180	B43821F1336M***
33	10 × 20	5.6	205	B43821A1336M***
47	10 × 20	4.9	210	B43821K1476M***
47	12.5 × 20	4.5	270	B43821F1476M***
68	12.5 × 20	3.0	350	B43821K1686M***
100	12.5 × 25	2.3	430	B43821F1107M***
100	16 × 25	1.8	475	B43821A1107M***
220	16 × 31.5	1.0	760	B43821F1227M***
220	18 × 31.5	0.84	800	B43821A1227M***
330	18 × 35	0.70	995	B43821F1337M***
470	20 × 40	0.42	1300	B43821F1477M***
680	25 × 40	0.34	1500	B43821F1687M***

 $V_R = 200 \text{ V DC}$

1	6.3 × 11	186	22	B43821A2105M***
2.2	6.3 × 11	85	33	B43821A2225M***
3.3	6.3 × 11	56	40	B43821A2335M***
4.7	6.3 × 11	40	50	B43821R2475M***
10	8 × 11.5	21	80	B43821G2106M***
22	10 × 16	8.4	155	B43821B2226M***

Composition of ordering code

*** = Version

000 = for standard leads, bulk

 001 = for kinked leads, bulk (from $d \times l = 10 \times 20 \text{ mm}$ to $18 \times 40 \text{ mm}$)

 002 = for cut leads, bulk (from $d \times l = 10 \times 12.5 \text{ mm}$ to $22 \times 40 \text{ mm}$)

 003 = for crimped leads, blister (from $d \times l = 16 \times 20 \text{ mm}$ to $20 \times 40 \text{ mm}$)

 004 = for J leads, blister (from $d \times l = 10 \times 12.5 \text{ mm}$ to $18 \times 35 \text{ mm}$)

 006 = for taped leads, Ammo pack, lead spacing $F = 3.5 \text{ mm}$ (for $d = 8 \text{ mm}$)

 007 = for taped leads, Ammo pack, lead spacing $F = 2.5 \text{ mm}$ (from $d = 5 \text{ mm}$ to 6.3 mm)

 008 = for taped leads, Ammo pack, lead spacing $F = 5.0 \text{ mm}$ (from $d \times l = 5 \times 11 \text{ mm}$ to $12.5 \times 25 \text{ mm}$)

 009 = for taped leads, Ammo pack, lead spacing $F = 7.5 \text{ mm}$ (for $d \times l = 16 \times 20 \dots 16 \times 31.5 \text{ mm}$ and $18 \times 25 \dots 18 \times 31.5 \text{ mm}$)

 012 = for bent 90° leads, blister (for $\varnothing 16$ and 18 mm)

B43821
Standard series – 85 °C
Technical data and ordering codes – B43821

C_R 120 Hz 20 °C μF	Case dimensions $d \times l$ mm	ESR_{max} 120 Hz 20 °C Ω	$I_{\text{AC,R}}$ 120 Hz 85 °C mA	Ordering code (composition see below)
$V_R = 200 \text{ V DC}$				
33	10 × 20	5.6	205	B43821B2336M***
47	12.5 × 20	4.5	270	B43821B2476M***
68	12.5 × 25	3.3	350	B43821B2686M***
100	16 × 25	1.8	475	B43821A2107M***
220	18 × 31.5	0.95	690	B43821B2227M***
330	20 × 35	0.65	950	B43821R2337M***
470	22 × 40	0.46	1300	B43821R2477M***
$V_R = 250 \text{ V DC}$				
0.47	6.3 × 11	395	15	B43821F2474M***
0.68	6.3 × 11	273	18	B43821F2684M***
1	6.3 × 11	186	22	B43821F2105M***
2.2	6.3 × 11	85	33	B43821F2225M***
3.3	6.3 × 11	65	40	B43821K2335M***
4.7	8 × 11.5	40	55	B43821K2475M***
10	10 × 12.5	23	95	B43821K2106M***
22	10 × 20	8.4	170	B43821F2226M***
33	12.5 × 20	5.6	230	B43821K2336M***
47	12.5 × 25	4.3	290	B43821K2476M***
68	16 × 25	2.7	380	B43821F2686M***
100	16 × 31.5	1.8	520	B43821K2107M***
220	18 × 40	0.84	680	B43821F2227M***
330	22 × 40	0.56	940	B43821F2337M***

Composition of ordering code

*** = Version

000 = for standard leads, bulk

 001 = for kinked leads, bulk (from $d \times l = 10 \times 20 \text{ mm}$ to $18 \times 40 \text{ mm}$)

 002 = for cut leads, bulk (from $d \times l = 10 \times 12.5 \text{ mm}$ to $22 \times 40 \text{ mm}$)

 003 = for crimped leads, blister (from $d \times l = 16 \times 20 \text{ mm}$ to $20 \times 40 \text{ mm}$)

 004 = for J leads, blister (from $d \times l = 10 \times 12.5 \text{ mm}$ to $18 \times 35 \text{ mm}$)

 006 = for taped leads, Ammo pack, lead spacing $F = 3.5 \text{ mm}$ (for $d = 8 \text{ mm}$)

 007 = for taped leads, Ammo pack, lead spacing $F = 2.5 \text{ mm}$ (from $d = 5 \text{ mm}$ to 6.3 mm)

 008 = for taped leads, Ammo pack, lead spacing $F = 5.0 \text{ mm}$ (from $d \times l = 5 \times 11 \text{ mm}$ to $12.5 \times 25 \text{ mm}$)

 009 = for taped leads, Ammo pack, lead spacing $F = 7.5 \text{ mm}$ (for $d \times l = 16 \times 20 \dots 16 \times 31.5 \text{ mm}$ and $18 \times 25 \dots 18 \times 31.5 \text{ mm}$)

 012 = for bent 90° leads, blister (for $\varnothing 16$ and 18 mm)

B43821
Standard series – 85 °C
Technical data and ordering codes – B43821

C_R 120 Hz 20 °C μF	Case dimensions $d \times l$ mm	ESR_{max} 120 Hz 20 °C Ω	$I_{\text{AC,R}}$ 120 Hz 85 °C mA	Ordering code (composition see below)
$V_R = 350 \text{ V DC}$				
0.47	6.3 × 11	395	15	B43821A4474M***
0.68	6.3 × 11	273	18	B43821A4684M***
1	6.3 × 11	186	22	B43821A4105M***
2.2	6.3 × 11	97	30	B43821F4225M***
2.2	8 × 11.5	85	38	B43821B4225M***
3.3	8 × 11.5	65	43	B43821F4335M***
4.7	8 × 11.5	45	55	B43821F4475M***
10	10 × 16	21	90	B43821F4106M***
22	12.5 × 20	9.0	170	B43821F4226M***
33	12.5 × 25	5.6	240	B43821F4336M***
47	16 × 25	4.0	300	B43821F4476M***
68	16 × 31.5	3.1	400	B43821F4686M***
100	18 × 35	2.3	520	B43821F4107M***
$V_R = 400 \text{ V DC}$				
2.2	8 × 11.5	97	38	B43821F9225M***
3.3	8 × 11.5	65	48	B43821F9335M***
4.7	10 × 12.5	46	60	B43821F9475M***
10	10 × 20	18	115	B43821A9106M***
22	12.5 × 25	8.4	200	B43821F9226M***
33	16 × 20	5.6	240	B43821F9336M***
47	16 × 25	4.0	280	B43821F9476M***
68	18 × 31.5	2.8	420	B43821A9686M***
100	18 × 40	1.9	450	B43821F9107M***

Composition of ordering code

*** = Version

000 = for standard leads, bulk

 001 = for kinked leads, bulk (from $d \times l = 10 \times 20 \text{ mm}$ to $18 \times 40 \text{ mm}$)

 002 = for cut leads, bulk (from $d \times l = 10 \times 12.5 \text{ mm}$ to $22 \times 40 \text{ mm}$)

 003 = for crimped leads, blister (from $d \times l = 16 \times 20 \text{ mm}$ to $20 \times 40 \text{ mm}$)

 004 = for J leads, blister (from $d \times l = 10 \times 12.5 \text{ mm}$ to $18 \times 35 \text{ mm}$)

 006 = for taped leads, Ammo pack, lead spacing $F = 3.5 \text{ mm}$ (for $d = 8 \text{ mm}$)

 007 = for taped leads, Ammo pack, lead spacing $F = 2.5 \text{ mm}$ (from $d = 5 \text{ mm}$ to 6.3 mm)

 008 = for taped leads, Ammo pack, lead spacing $F = 5.0 \text{ mm}$ (from $d \times l = 5 \times 11 \text{ mm}$ to $12.5 \times 25 \text{ mm}$)

 009 = for taped leads, Ammo pack, lead spacing $F = 7.5 \text{ mm}$ (for $d \times l = 16 \times 20 \dots 16 \times 31.5 \text{ mm}$ and $18 \times 25 \dots 18 \times 31.5 \text{ mm}$)

 012 = for bent 90° leads, blister (for $\varnothing 16$ and 18 mm)

B43821
Standard series – 85 °C
Technical data and ordering codes – B43821

C_R 120 Hz 20 °C μF	Case dimensions $d \times l$ mm	ESR_{max} 120 Hz 20 °C Ω	$I_{\text{AC,R}}$ 120 Hz 85 °C mA	Ordering code (composition see below)
$V_R = 450 \text{ V DC}$				
2.2	8 × 11.5	97	28	B43821F5225M***
3.3	10 × 12.5	65	40	B43821F5335M***
4.7	10 × 12.5	45	50	B43821K5475M***
10	10 × 20	26	80	B43821F5106M***
22	12.5 × 25	14	140	B43821F5226M***
33	16 × 25	7.6	180	B43821F5336M***
47	16 × 31.5	4.8	220	B43821F5476M***
68	18 × 35	2.7	275	B43821A5686M***
100	20 × 40	1.8	295	B43821A5107M***

Composition of ordering code

*** = Version

000 = for standard leads, bulk

 001 = for kinked leads, bulk (from $d \times l = 10 \times 20 \text{ mm}$ to $18 \times 40 \text{ mm}$)

 002 = for cut leads, bulk (from $d \times l = 10 \times 12.5 \text{ mm}$ to $22 \times 40 \text{ mm}$)

 003 = for crimped leads, blister (from $d \times l = 16 \times 20 \text{ mm}$ to $20 \times 40 \text{ mm}$)

 004 = for J leads, blister (from $d \times l = 10 \times 12.5 \text{ mm}$ to $18 \times 35 \text{ mm}$)

 006 = for taped leads, Ammo pack, lead spacing $F = 3.5 \text{ mm}$ (for $d = 8 \text{ mm}$)

 007 = for taped leads, Ammo pack, lead spacing $F = 2.5 \text{ mm}$ (from $d = 5 \text{ mm}$ to 6.3 mm)

 008 = for taped leads, Ammo pack, lead spacing $F = 5.0 \text{ mm}$ (from $d \times l = 5 \times 11 \text{ mm}$ to $12.5 \times 25 \text{ mm}$)

 009 = for taped leads, Ammo pack, lead spacing $F = 7.5 \text{ mm}$ (for $d \times l = 16 \times 20 \dots 16 \times 31.5 \text{ mm}$ and $18 \times 25 \dots 18 \times 31.5 \text{ mm}$)

 012 = for bent 90° leads, blister (for $\varnothing 16$ and 18 mm)



B41821, B43821

Standard series – 85 °C

Useful life

depending on ambient temperature T_A under ripple current operating conditions¹⁾

$V_R = 6.3 \dots 100 \text{ V DC}$

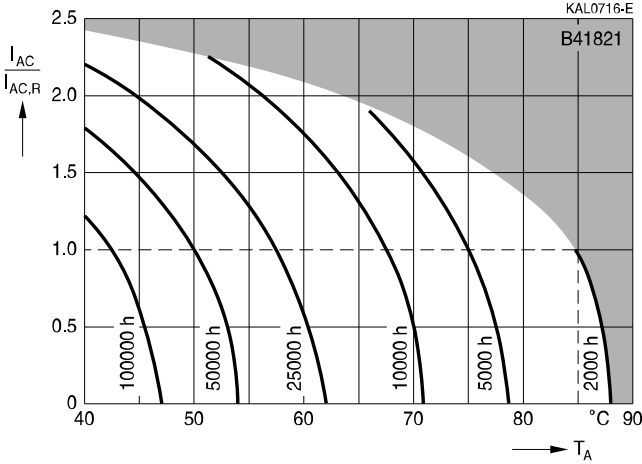

$V_R = 160 \dots 450 \text{ V DC}$

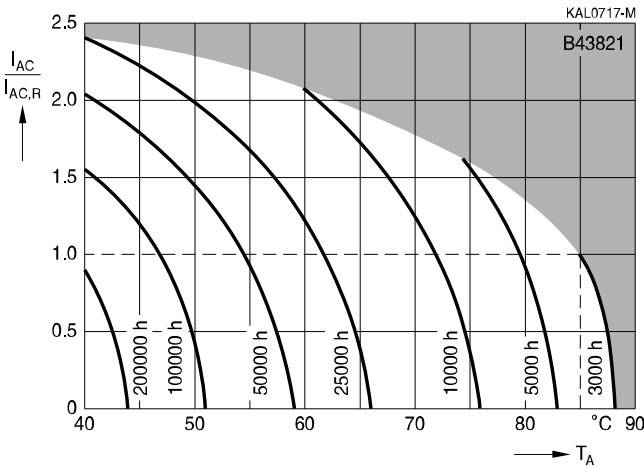

1) Refer to chapter "General technical information, 5.3 Calculation of useful life" for an explanation on how to interpret the useful life graphs.



B41821, B43821

Standard series – 85 °C

Frequency factor of permissible ripple current I_{AC} versus frequency f

$V_R \leq 100$ V DC



Frequency factor of permissible ripple current I_{AC} versus frequency f

$V_R \geq 160$ V DC





Taping, packing and lead configurations

Taping

Single-ended capacitors are available taped in Ammo pack from diameter 8 to 18 mm as follows:

Lead spacing $F = 3.5$ mm ($\varnothing d = 8$ mm)

Lead spacing $F = 5.0$ mm ($\varnothing d = 8 \dots 12.5$ mm)

Lead spacing $F = 7.5$ mm ($\varnothing d = 16 \dots 18$ mm).

Lead spacing 3.5 mm ($\varnothing d = 8$ mm)

Last 3 digits of ordering code: 006

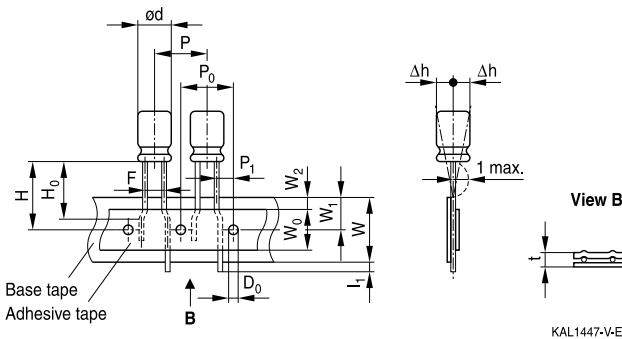

Dimensions in mm

$\varnothing d$	F	H	W	W_0	W_1	W_2	P	P_0	P_1	l_1	t	Δh	D_0
8	3.5	18.5	18.0	9.5	9.0	3.0	12.7	12.7	4.6	1.0	0.7	1.0	4.0
Tolerance	+0.8 -0.2	± 1.0	± 0.5	min.	± 0.5	max.	± 1.0	± 0.3	± 0.6	max.	± 0.2	max.	± 0.2

Leads can also run straight through the taping area.



B41821, B43821

Standard series – 85 °C

Lead spacing 5.0 mm (∅ d = 8 mm)

Last 3 digits of ordering code: 008

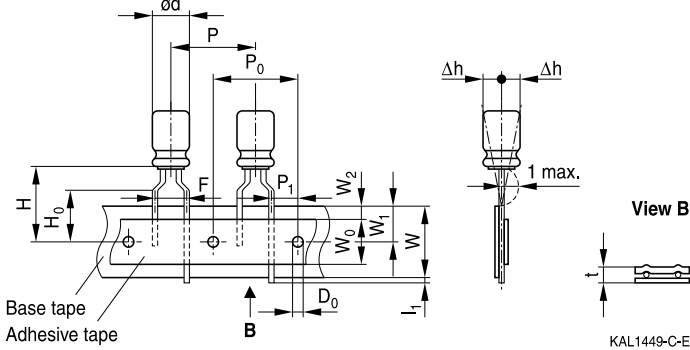

Lead spacing 5.0 mm (∅ d = 10 ... 12.5 mm)

Last 3 digits of ordering code: 008

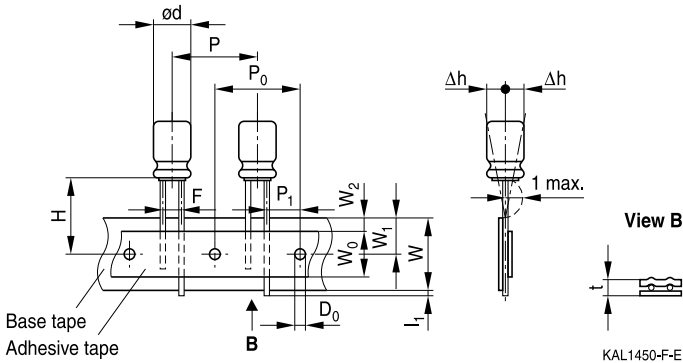

Dimensions in mm

∅ d	F	H	W	W ₀	W ₁	W ₂	H ₀	P	P ₀	P ₁	l ₁	t	Δh	D ₀
4 ... 6.3	5.0	18.5	18.0	5.5	9.0	1.5	16.0	12.7	12.7	3.85	1.0	0.6	1.0	4.0
8	5.0	20.0	18.0	9.5	9.0	1.5	16.0	12.7	12.7	3.85	1.0	0.6	1.0	4.0
10		19.0		9.5			–	12.7	12.7	3.85				
12.5		19.0		11.5			–	15.0	15.0	5.0				
Tolerance	+0.8 –0.2	±0.75	±0.5	min.	±0.5	max.	±0.5	±1.0	±0.2	±0.5	max.	+0.3 –0.2	max.	±0.2

Taping is available up to dimensions d × l = 12.5 × 25 mm.

Lead spacing 7.5 mm (∅ d = 16 ...18 mm)

Last 3 digits of ordering code: 009

Dimensions in mm

∅ d	F	H	W	W ₀	W ₁	W ₂	P	P ₀	P ₁	l ₁	t	ΔP	Δh	D ₀
16	7.5	18.5	18.0	12.5	9.0	1.5	30.0	15.0	3.75	1.0	0.7	0	0	4.0
18														
Tolerance	±0.8	-0.5 +0.75	±0.5	min.	±0.5	max.	±1.0	±0.2	±0.5	max.	±0.2	±1.0	±1.0	±0.2

 Taping is available up to dimensions $d \times l = 16 \times 31.5$ mm and 18×31.5 mm.



B41821, B43821

Standard series – 85 °C

Cut or kinked leads

Single-ended capacitors are available with cut or kinked leads. Other lead configurations also available upon request.

Cut leads

Last 3 digits of ordering code: 002

With stand-off rubber seal



KAL1085-I

With flat rubber seal

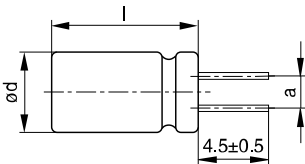

KAL1086-R

Case size d × l (mm)	Dimensions (mm) a ±0.5
10 × 12.5	5.0
10 × 16	5.0
10 × 20	5.0
12.5 × 20	5.0
12.5 × 25	5.0
16 × 20	7.5
16 × 25	7.5
16 × 31.5	7.5
16 × 35.5	7.5
18 × 20	7.5
18 × 25	7.5
18 × 31.5	7.5
18 × 35	7.5
18 × 40	7.5

Kinked leads

Last 3 digits of ordering code: 001

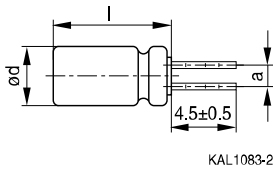
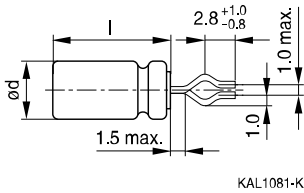
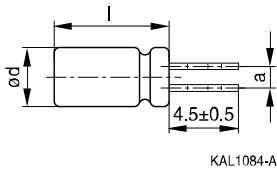
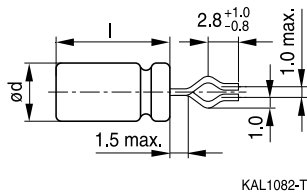
With stand-off rubber seal

With flat rubber seal

Case size d × l (mm)	Dimensions (mm) a ±0.5
10 × 20	5.0
12.5 × 20	5.0
12.5 × 25	5.0
16 × 20	7.5
16 × 25	7.5
16 × 31.5	7.5
16 × 35.5	7.5
18 × 20	7.5
18 × 25	7.5
18 × 31.5	7.5
18 × 35	7.5
18 × 40	7.5



B41821, B43821

Standard series – 85 °C

PAPR leads (Protection Against Polarity Reversal)

These lead configurations ensure correct placement of the capacitor on the PCB with regard to polarity. PAPR leads are available for diameters from 10 mm up to 18 mm (excluding $d \times l = 12.5 \times 30/35/40$ mm).

There are three configurations available: Crimped leads, J leads, bent 90° leads

Crimped leads

Last 3 digits of ordering code: 003

With stand-off rubber seal



With flat rubber seal



Suggestion for PCB hole diameter



Case size $d \times l$ (mm)	Dimensions (mm)					
	B ±0.2	C ±0.5	D ±0.1	E ±0.1	a ±0.5	Øb
16 × 20	1.5	3.0	1.3	0.3	7.5	0.8 ±0.05
16 × 25	1.5	3.0	1.3	0.3	7.5	0.8 ±0.05
16 × 31.5	1.5	3.0	1.3	0.3	7.5	0.8 ±0.05
16 × 35.5	1.5	3.0	1.3	0.3	7.5	0.8 ±0.05
18 × 20	1.5	3.0	1.3	0.3	7.5	0.8 ±0.1
18 × 25	1.5	3.0	1.3	0.3	7.5	0.8 ±0.1
18 × 31.5	1.5	3.0	1.3	0.3	7.5	0.8 ±0.1
18 × 35	1.5	3.0	1.3	0.3	7.5	0.8 ±0.1
18 × 40	1.5	3.0	1.3	0.3	7.5	0.8 ±0.1

J leads

Last 3 digits of ordering code: 004

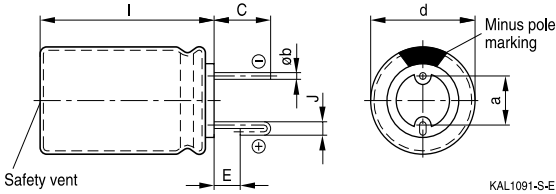
Suggestion for PCB hole diameter

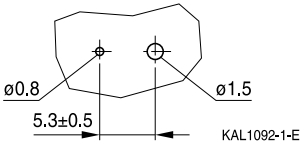
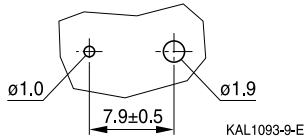
 Suggestion for PCB hole diameter,
wire $\varnothing 0.6$ mm

 Suggestion for PCB hole diameter,
wire $\varnothing 0.8$ mm

Case size d × l (mm)	Dimensions (mm)				
	C ±0.5	E ±0.5	J ±0.2	a ±0.5	∅b
10 × 12.5	3.2	0.7	1.2	5.0	0.6 ±0.05
10 × 16	3.2	0.7	1.2	5.0	0.6 ±0.05
10 × 20	3.2	0.7	1.2	5.0	0.6 ±0.05
12.5 × 20	3.2	0.7	1.2	5.0	0.6 ±0.05
12.5 × 25	3.2	0.7	1.2	5.0	0.6 ±0.05
16 × 20	3.5	0.7	1.6	7.5	0.8 ±0.05
16 × 25	3.5	0.7	1.6	7.5	0.8 ±0.05
16 × 31.5	3.5	0.7	1.6	7.5	0.8 ±0.05
16 × 35.5	3.5	0.7	1.6	7.5	0.8 ±0.05
18 × 20	3.5	0.7	1.6	7.5	0.8 ±0.1
18 × 25	3.5	0.7	1.6	7.5	0.8 ±0.1
18 × 31.5	3.5	0.7	1.6	7.5	0.8 ±0.1
18 × 35	3.5	0.7	1.6	7.5	0.8 ±0.1



B41821, B43821

Standard series – 85 °C

Bent 90° leads for horizontal mounting pinning

Last 3 digits of ordering code: 012

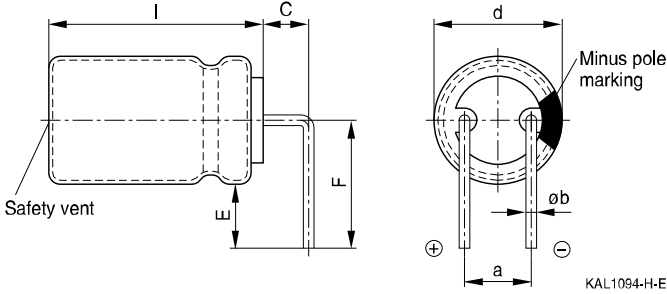

Case size d × l (mm)	Dimensions (mm)				
	C ±0.5	E ±0.5	F ±0.5	a ±0.5	Øb
16 × 20	4.0	4.0	12.0	7.5	0.8 ±0.05
16 × 25	4.0	4.0	12.0	7.5	0.8 ±0.05
16 × 31.5	4.0	4.0	12.0	7.5	0.8 ±0.05
16 × 35.5	4.0	4.0	12.0	7.5	0.8 ±0.05
18 × 20	4.0	4.0	13.0	7.5	0.8 ±0.1
18 × 25	4.0	4.0	13.0	7.5	0.8 ±0.1
18 × 31.5	4.0	4.0	13.0	7.5	0.8 ±0.1
18 × 35	4.0	4.0	13.0	7.5	0.8 ±0.1
18 × 40	4.0	4.0	13.0	7.5	0.8 ±0.1

Bent leads for diameter 12.5 mm available upon request.



Packing units and box dimensions

Ammo pack

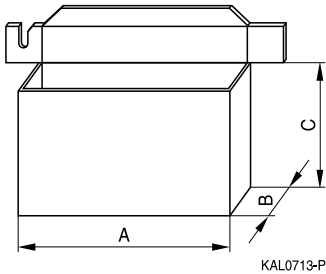

Case size $d \times l$ mm	Dimensions (mm)			Packing units pcs.
	A_{max}	B_{max}	C_{max}	
8 × 11.5	345	55	240	1000
10 × 12.5	345	55	280	750
10 × 16	345	60	200	500
10 × 20	345	60	200	500
12.5 × 20	345	65	280	500
12.5 × 25	345	65	280	500
16 × 20	315	65	275	300
16 × 25	315	65	275	300
16 × 31.5	315	65	275	300
18 × 20	315	65	275	250
18 × 25	315	65	275	250
18 × 31.5	315	65	275	250

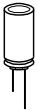

B41821, B43821

Standard series – 85 °C

Overview of packing units and code numbers for case sizes 8 × 11.5 ... 16 × 35.5

					PAPR				
Case size d × l	Stan- dard, bulk	Taped, Ammo pack		Kinked leads, bulk	Cut leads, bulk	Crimped leads, blister	J leads, blister	Bent 90° leads, blister	
mm	pcs.	pcs.		pcs.	pcs.	pcs.	pcs.	pcs.	
8 × 11.5	1000	1000		–	–	–	–		
10 × 12.5	1000	750		–	1000	–	675		
10 × 16	1000	500		–	1000	–	675		
10 × 20	500	500		500	500	–	500		
12.5 × 20	350	500		350	350	–	300	1)	
12.5 × 25	250	500		500	500	–	225	1)	
12.5 × 30	200	–		–	–	–	–		
12.5 × 35	175	–		–	–	–	–		
12.5 × 40	175	–		–	–	–	–		
16 × 20	250	300		200	200	200	200	120	
16 × 25	250	300		200	200	200	200	216	
16 × 31.5	200	300		250	250	344	344	180	
16 × 35.5	100	–		100	100	150	150	150	
The last three digits of the complete ordering code state the lead configuration	000	Code	F (mm)	d (mm)	001	002	003	004	012
		006	3.5	8					
		008	5	8...12.5					
		009	7.5	16...18					

1) Available upon request

Overview of packing units and code numbers for case sizes 18 × 20 ... 18 × 40

					PAPR				
Case size d × l mm	Standard, bulk pcs.	Taped, Ammo pack pcs.			Kinked leads, bulk pcs.	Cut leads, bulk pcs.	Crimped leads, blister pcs.	J leads, blister pcs.	Bent 90° leads, blister pcs.
18 × 20	175	250			175	175	200	200	120
18 × 25	150	250			150	150	200	200	120
18 × 31.5	100	250			100	100	150	150	120
18 × 35	100	–			100	100	150	150	150
18 × 40	125	–			100	100	120	–	72
The last three digits of the complete ordering code state the lead configuration	000	Code	F (mm)	d (mm)	001	002	003	004	012
		009	7.5	16...18					



B41821, B43821

Standard series – 85 °C

Cautions and warnings

Personal safety

The electrolytes used by EPCOS have been optimized both with a view to the intended application and with regard to health and environmental compatibility. They do not contain any solvents that are detrimental to health, e.g. dimethyl formamide (DMF) or dimethyl acetamide (DMAC).

Furthermore, some of the high-voltage electrolytes used by EPCOS are self-extinguishing.

As far as possible, EPCOS does not use any dangerous chemicals or compounds to produce operating electrolytes. However, in exceptional cases, such materials must be used in order to achieve specific physical and electrical properties because no alternative materials are currently known. However, the amount of dangerous materials used in our products is limited to an absolute minimum.

Materials and chemicals used in EPCOS aluminum electrolytic capacitors are continuously adapted in compliance with the EPCOS Corporate Environmental Policy and the latest EU regulations and guidelines such as RoHS, REACH/SVHC, GADSL, and ELV.

MDS (Material Data Sheets) are available on the EPCOS website for all types listed in the data book. MDS for customer specific capacitors are available upon request.

MSDS (Material Safety Data Sheets) are available for all of our electrolytes upon request.

Nevertheless, the following rules should be observed when handling aluminum electrolytic capacitors: No electrolyte should come into contact with eyes or skin. If electrolyte does come into contact with the skin, wash the affected areas immediately with running water. If the eyes are affected, rinse them for 10 minutes with plenty of water. If symptoms persist, seek medical treatment. Avoid inhaling electrolyte vapor or mists. Workplaces and other affected areas should be well ventilated. Clothing that has been contaminated by electrolyte must be changed and rinsed in water.



Product safety

The table below summarizes the safety instructions that must be observed without fail. A detailed description can be found in the relevant sections of chapter "General technical information".

Topic	Safety information	Reference chapter "General technical information"
Polarity	Make sure that polar capacitors are connected with the right polarity.	1 "Basic construction of aluminum electrolytic capacitors"
Reverse voltage	Voltages polarity classes should be prevented by connecting a diode.	3.1.6 "Reverse voltage"
Mounting position of screw-terminal capacitors	Do not mount the capacitor with the terminals (safety vent) upside down.	11.1. "Mounting positions of capacitors with screw terminals"
Robustness of terminals	The following maximum tightening torques must not be exceeded when connecting screw terminals: M5: 2.5 Nm M6: 4.0 Nm	11.3 "Mounting torques"
Mounting of single-ended capacitors	The internal structure of single-ended capacitors might be damaged if excessive force is applied to the lead wires. Avoid any compressive, tensile or flexural stress. Do not move the capacitor after soldering to PC board. Do not pick up the PC board by the soldered capacitor. Do not insert the capacitor on the PC board with a hole space different to the lead space specified.	11.4 "Mounting considerations for single-ended capacitors"
Soldering	Do not exceed the specified time or temperature limits during soldering.	11.5 "Soldering"
Soldering, cleaning agents	Do not allow halogenated hydrocarbons to come into contact with aluminum electrolytic capacitors.	11.6 "Cleaning agents"
Upper category temperature	Do not exceed the upper category temperature.	7.2 "Maximum permissible operating temperature"
Passive flammability	Avoid external energy, such as fire or electricity.	8.1 "Passive flammability"



B41821, B43821

Standard series – 85 °C

Topic	Safety information	Reference chapter "General technical information"
Active flammability	Avoid overload of the capacitors.	8.2 "Active flammability"
Maintenance	<p>Make periodic inspections of the capacitors. Before the inspection, make sure that the power supply is turned off and carefully discharge the electricity of the capacitors.</p> <p>Do not apply any mechanical stress to the capacitor terminals.</p>	10 "Maintenance"
Storage	Do not store capacitors at high temperatures or high humidity. Capacitors should be stored at +5 to +35 °C and a relative humidity of $\leq 75\%$.	7.3 Storage conditions
		Reference chapter "Capacitors with screw terminals"
Breakdown strength of insulating sleeves	Do not damage the insulating sleeve, especially when ring clips are used for mounting.	"Screw terminals – accessories"

Symbols and terms

Symbol	English	German
C	Capacitance	Kapazität
C_R	Rated capacitance	Nennkapazität
C_S	Series capacitance	Serienkapazität
$C_{S,T}$	Series capacitance at temperature T	Serienkapazität bei Temperatur T
C_f	Capacitance at frequency f	Kapazität bei Frequenz f
d	Case diameter, nominal dimension	Gehäusedurchmesser, Nennmaß
d_{max}	Maximum case diameter	Maximaler Gehäusedurchmesser
ESL	Self-inductance	Eigeninduktivität
ESR	Equivalent series resistance	Ersatzserienwiderstand
ESR_f	Equivalent series resistance at frequency f	Ersatzserienwiderstand bei Frequenz f
ESR_T	Equivalent series resistance at temperature T	Ersatzserienwiderstand bei Temperatur T
f	Frequency	Frequenz
I	Current	Strom
I_{AC}	Alternating current (ripple current)	Wechselstrom
$I_{AC,rms}$	Root-mean-square value of alternating current	Wechselstrom, Effektivwert
$I_{AC,f}$	Ripple current at frequency f	Wechselstrom bei Frequenz f
$I_{AC,max}$	Maximum permissible ripple current	Maximal zulässiger Wechselstrom
$I_{AC,R}$	Rated ripple current	Nennwechselstrom
$I_{AC,R} (B)$	Rated ripple current for base cooling	Nennwechselstromstrom für Bodenkühlung
I_{leak}	Leakage current	Reststrom
$I_{leak,op}$	Operating leakage current	Betriebsreststrom
l	Case length, nominal dimension	Gehäuselänge, Nennmaß
l_{max}	Maximum case length (without terminals and mounting stud)	Maximale Gehäuselänge (ohne Anschlüsse und Gewindebolzen)
R	Resistance	Widerstand
R_{ins}	Insulation resistance	Isolationswiderstand
R_{symm}	Balancing resistance	Symmetrierwiderstand
T	Temperature	Temperatur
ΔT	Temperature difference	Temperaturdifferenz
T_A	Ambient temperature	Umgebungstemperatur
T_C	Case temperature	Gehäusetemperatur
T_B	Capacitor base temperature	Temperatur des Becherbodens
t	Time	Zeit
Δt	Period	Zeitraum
t_b	Service life (operating hours)	Brauchbarkeitsdauer (Betriebszeit)



B41821, B43821

Standard series – 85 °C

Symbol	English	German
V	Voltage	Spannung
V _F	Forming voltage	Formierspannung
V _{op}	Operating voltage	Betriebsspannung
V _R	Rated voltage, DC voltage	Nennspannung, Gleichspannung
V _S	Surge voltage	Spitzenspannung
X _C	Capacitive reactance	Kapazitiver Blindwiderstand
X _L	Inductive reactance	Induktiver Blindwiderstand
Z	Impedance	Scheinwiderstand
Z _T	Impedance at temperature T	Scheinwiderstand bei Temperatur T
tan δ	Dissipation factor	Verlustfaktor
λ	Failure rate	Ausfallrate
ε ₀	Absolute permittivity	Elektrische Feldkonstante
ε _r	Relative permittivity	Dielektrizitätszahl
ω	Angular velocity; $2 \cdot \pi \cdot f$	Kreisfrequenz; $2 \cdot \pi \cdot f$

Note

All dimensions are given in mm.

Important notes

The following applies to all products named in this publication:

1. Some parts of this publication contain **statements about the suitability of our products for certain areas of application**. These statements are based on our knowledge of typical requirements that are often placed on our products in the areas of application concerned. We nevertheless expressly point out **that such statements cannot be regarded as binding statements about the suitability of our products for a particular customer application**. As a rule, EPCOS is either unfamiliar with individual customer applications or less familiar with them than the customers themselves. For these reasons, it is always ultimately incumbent on the customer to check and decide whether an EPCOS product with the properties described in the product specification is suitable for use in a particular customer application.
2. We also point out that **in individual cases, a malfunction of electronic components or failure before the end of their usual service life cannot be completely ruled out in the current state of the art, even if they are operated as specified**. In customer applications requiring a very high level of operational safety and especially in customer applications in which the malfunction or failure of an electronic component could endanger human life or health (e.g. in accident prevention or lifesaving systems), it must therefore be ensured by means of suitable design of the customer application or other action taken by the customer (e.g. installation of protective circuitry or redundancy) that no injury or damage is sustained by third parties in the event of malfunction or failure of an electronic component.
3. **The warnings, cautions and product-specific notes must be observed.**
4. In order to satisfy certain technical requirements, **some of the products described in this publication may contain substances subject to restrictions in certain jurisdictions (e.g. because they are classed as hazardous)**. Useful information on this will be found in our Material Data Sheets on the Internet (www.epcos.com/material). Should you have any more detailed questions, please contact our sales offices.
5. We constantly strive to improve our products. Consequently, **the products described in this publication may change from time to time**. The same is true of the corresponding product specifications. Please check therefore to what extent product descriptions and specifications contained in this publication are still applicable before or when you place an order. We also **reserve the right to discontinue production and delivery of products**. Consequently, we cannot guarantee that all products named in this publication will always be available. The aforementioned does not apply in the case of individual agreements deviating from the foregoing for customer-specific products.
6. Unless otherwise agreed in individual contracts, **all orders are subject to the current version of the "General Terms of Delivery for Products and Services in the Electrical Industry" published by the German Electrical and Electronics Industry Association (ZVEI)**.
7. The trade names EPCOS, BAOKE, Alu-X, CeraDiode, CeraLink, CSMP, CSSP, CTVS, DeltaCap, DigiSiMic, DSSP, FilterCap, FormFit, MiniBlue, MiniCell, MKD, MKK, MLSC, MotorCap, PCC, PhaseCap, PhaseCube, PhaseMod, PhiCap, SIFERRIT, SIFI, SIKOREL, SilverCap, SIMDAD, SiMic, SIMID, SineFormer, SIOV, SIP5D, SIP5K, ThermoFuse, WindCap are **trademarks registered or pending** in Europe and in other countries. Further information will be found on the Internet at www.epcos.com/trademarks.



Стандарт Электрон Связь

Мы молодая и активно развивающаяся компания в области поставок электронных компонентов. Мы поставляем электронные компоненты отечественного и импортного производства напрямую от производителей и с крупнейших складов мира.

Благодаря сотрудничеству с мировыми поставщиками мы осуществляем комплексные и плановые поставки широчайшего спектра электронных компонентов.

Собственная эффективная логистика и склад в обеспечивает надежную поставку продукции в точно указанные сроки по всей России.

Мы осуществляем техническую поддержку нашим клиентам и предпродажную проверку качества продукции. На все поставляемые продукты мы предоставляем гарантию .

Осуществляем поставки продукции под контролем ВП МО РФ на предприятия военно-промышленного комплекса России , а также работаем в рамках 275 ФЗ с открытием отдельных счетов в уполномоченном банке. Система менеджмента качества компании соответствует требованиям ГОСТ ISO 9001.

Минимальные сроки поставки, гибкие цены, неограниченный ассортимент и индивидуальный подход к клиентам являются основой для выстраивания долгосрочного и эффективного сотрудничества с предприятиями радиоэлектронной промышленности, предприятиями ВПК и научно-исследовательскими институтами России.

С нами вы становитесь еще успешнее!

Наши контакты:

Телефон: +7 812 627 14 35

Электронная почта: sales@st-electron.ru

Адрес: 198099, Санкт-Петербург,
Промышленная ул, дом № 19, литера Н,
помещение 100-Н Офис 331