



TS7211

SINGLE BiCMOS RAIL TO RAIL μPOWER COMPARATOR

- RAIL TO RAIL INPUTS
- PUSH-PULL OUTPUT
- SUPPLY OPERATION FROM 2.7V TO 10V
- TYPICAL SUPPLY CURRENT: 6μA @ 5V
- RESPONSE TIME OF 0.5μs AT 5V
- LOW INPUT CURRENT
- ESD PROTECTION : 2KV (HBM) 200V (MM)
- AVAILABLE IN TINY SOT23-5 PACKAGE

DESCRIPTION

The TS7211 is a micropower comparator featuring rail to rail input performance in a tiny SOT23-5 package. This comparator is ideally suited to space and weight critical applications. It is fully specified at 2.7V, 5V and 10V operations over the industrial temperature range (-40/+85°C).

The TS7211 features a push-pull output stage. The speed to power ratio makes this device ultra versatile for a wide range of applications.

APPLICATIONS

- Battery powered systems
- Notebooks and PDAs
- PCMCIA cards
- Cellulare and mobile communication
- Alarm and security systems
- Replacement of amplifiers used in comparator configuration with better performances

ORDER CODE

Part Number	Temperature Range	Package	SOT23-5 Marking
		L	
TS7211AI	-40°C, +85°C	•	K515
TS7211BI		•	K516
Example : TS7211AILT			

L = Tiny Package (SOT23-5) - only available in Tape & Reel (LT)

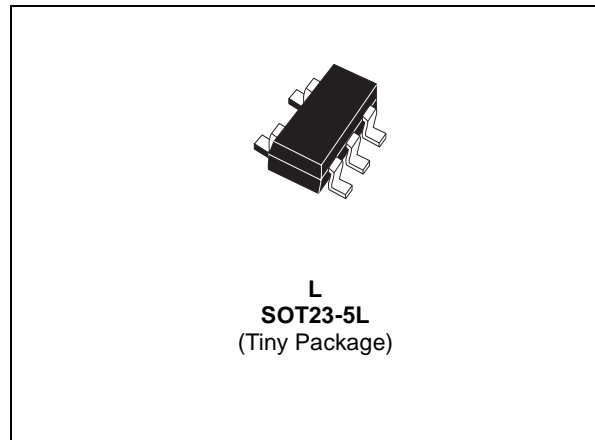

PIN CONNECTIONS (top view)

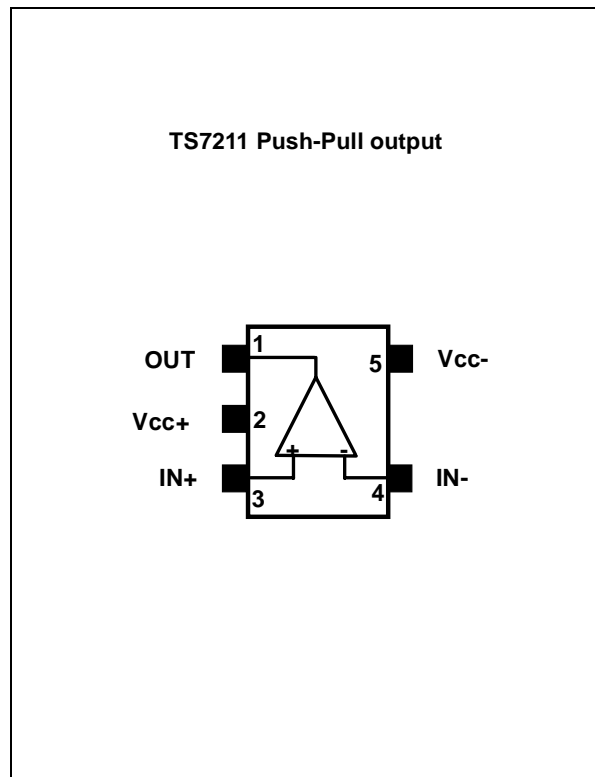

ABSOLUTE MAXIMUM RATINGS

Symbol	Parameter	Value	Unit
ESD	Human body model (HBM)	2000	V
	Machine model (MM)	200	
V_{ID}	Differential Input Voltage	$(V_{CC}^-) - 0.3$ to $(V_{CC}^+) + 0.3$	V
V_{IN} & V_{OUT}	Input and output Voltages ¹⁾	$(V_{CC}^-) - 0.3$ to $(V_{CC}^+) + 0.3$	V
V_{CC}	Supply voltage	12	V
I_{IN}	Current at input pins	± 5	mA
I_{OUT}	Current at output pin	± 30	mA
T_{Lead}	Lead temperature (soldering 10 seconds)	250	°C
T_{STG}	Storage Temperature	-65 to +150	°C
T_J	Junction Temperature	150	°C
P_D	Power dissipation ²⁾ SOT23-5	500	mW

1. The magnitude of input and output voltages must never exceed 0.3V beyond the supply voltage.

2. $T_J = 150^\circ\text{C}$, $T_{AMB} = 25^\circ\text{C}$ with $R_{TH-JA} = 250^\circ\text{C/W}$ for SOT23-5 package

OPERATING CONDITIONS

Symbol	Parameter	Value	Unit
V_{CC}	Supply Voltage	2.7 to 10	V
T_{AMB}	Ambient Temperature	-40 to +85	°C
V_{ICM}	Common mode input voltage range	$(V_{CC}^-) - 0.3$ to $(V_{CC}^+) + 0.3$	V

ELECTRICAL CHARACTERISTICS $V_{CC}^+ = 2.7V$, $T_{AMB} = 25^\circ C$ (unless otherwise specified)

Symbol	Parameter	Min.	Typ.	Max.	Unit
V_{IO}	Input Offset Voltage (Full common mode range) TS7211A $T_{MIN} \leq T_{AMB} \leq T_{MAX}$ TS7211B $T_{MIN} \leq T_{AMB} \leq T_{MAX}$			7 10 15 18	mV
ΔV_{IO}	Input Offset Voltage Drift with temperature		6		$\mu V/^\circ C$
I_{IB}	Input Bias Current ¹⁾ $T_{MIN} \leq T_{AMB} \leq T_{MAX}$		1	300 600	pA
I_{IO}	Input Offset Current ¹⁾ $T_{MIN} \leq T_{AMB} \leq T_{MAX}$		1	150 300	pA
CMRR	Common-mode Rejection Ratio ($0 < V_{icm} < 2.7V$)		65		dB
PSRR	Power Supply Rejection Ratio ($2.7 < V_{CC} < 10V$)		80		dB
A_{VD}	Voltage Gain ²⁾		240		dB
V_{ICM}	Input Common Mode Voltage Range (upper rail) $T_{MIN} \leq T_{AMB} \leq T_{MAX}$	3 2.7			V
	Input Common Mode Voltage Range (lower rail) $T_{MIN} \leq T_{AMB} \leq T_{MAX}$	-0.3 0.0			
V_{OH}	High Level Output Voltage - $I_{source} = 2.5mA$ $T_{MIN} \leq T_{AMB} \leq T_{MAX}$	2.35 2.15	2.45		V
V_{OL}	Low Level Output Voltage - $I_{sink} = 2.5mA$ $T_{MIN} \leq T_{AMB} \leq T_{MAX}$		0.2	0.35 0.45	V
I_{CC}	Supply Current No load, output low		6	12	μA
	No load, output high		8	14	
T_{PLH}	Response Time Low to High ($V_{ic} = 1.35V$, $C_L = 50pF$) Overdrive = 10mV Overdrive = 100mV		1.5 0.6		μs
T_{PHL}	Response Time Low to High ($V_{ic} = 1.35V$, $C_L = 50pF$) Overdrive = 10mV Overdrive = 100mV		1.5 0.5		μs
T_F	Fall Time ($C_L = 50pF$) Overdrive = 100mV		20		ns
T_R	Rise Time ($C_L = 50pF$) Overdrive = 100mV		20		ns

1) Maximum values include unavoidable inaccuracies of the industrial test.

2) Design evaluation.

3) Limits are 100% production tested at +25°C. Limits over temperature are guaranteed through correlation and by design.

ELECTRICAL CHARACTERISTICS

$V_{CC}^+ = 5V$, $T_{AMB} = 25^\circ C$ (unless otherwise specified)

Symbol	Parameter	Min.	Typ.	Max.	Unit
V_{IO}	Input Offset Voltage (Full common mode range) TS7211A $T_{MIN} \leq T_{AMB} \leq T_{MAX}$ TS7211B $T_{MIN} \leq T_{AMB} \leq T_{MAX}$			7 10 15 18	mV
ΔV_{IO}	Input Offset Voltage Drift with temperature		6		$\mu V/^\circ C$
I_{IB}	Input Bias Current ¹⁾ $T_{MIN} \leq T_{AMB} \leq T_{MAX}$		1	300 600	pA
I_{IO}	Input Offset Current ¹⁾ $T_{MIN} \leq T_{AMB} \leq T_{MAX}$		1	150 300	pA
CMRR	Common-mode Rejection Ratio ($0 < V_{icm} < 5V$)		70		dB
PSRR	Power Supply Rejection Ratio ($2.7 < V_{CC} < 10V$)		80		dB
A_{VD}	Voltage Gain ²⁾		240		dB
V_{ICM}	Input Common Mode Voltage Range (upper rail) $T_{MIN} \leq T_{AMB} \leq T_{MAX}$	5.3 5.0			V
	Input Common Mode Voltage Range (lower rail) $T_{MIN} \leq T_{AMB} \leq T_{MAX}$	-0.3 0.0			
V_{OH}	High Level Output Voltage - $I_{source} = 5mA$ $T_{MIN} \leq T_{AMB} \leq T_{MAX}$	4.6 4.45	4.8		V
V_{OL}	Low Level Output Voltage - $I_{sink} = 5mA$ $T_{MIN} \leq T_{AMB} \leq T_{MAX}$		0.2	0.40 0.55	V
I_{CC}	Supply Current No load, output low		6	12	μA
	No load, output high		8	14	
T_{PLH}	Response Time Low to High ($V_{ic} = 2.5V$, $C_L = 50pF$) Overdrive = 10mV Overdrive = 100mV		2 0.5		μs
T_{PHL}	Response Time Low to High ($V_{ic} = 2.5V$, $C_L = 50pF$) Overdrive = 10mV Overdrive = 100mV		2 0.4		μs
T_F	Fall Time ($C_L = 50pF$) Overdrive = 100mV		20		ns
T_R	Rise Time ($C_L = 50pF$) Overdrive = 100mV		20		ns

1) Maximum values include unavoidable inaccuracies of the industrial test.

2) Design evaluation.

3) Limits are 100% production tested at +25°C. Limits over temperature are guaranteed through correlation and by design.

ELECTRICAL CHARACTERISTICS $V_{CC}^+ = 10V$, $T_{AMB} = 25^\circ C$ (unless otherwise specified)

Symbol	Parameter	Min.	Typ.	Max.	Unit
V_{IO}	Input Offset Voltage (Full common mode range) TS7211A $T_{MIN} \leq T_{AMB} \leq T_{MAX}$ TS7211B $T_{MIN} \leq T_{AMB} \leq T_{MAX}$			7 10 15 18	mV
ΔV_{IO}	Input Offset Voltage Drift with temperature		6		$\mu V/^\circ C$
I_{IB}	Input Bias Current ¹⁾ $T_{MIN} \leq T_{AMB} \leq T_{MAX}$		1	300 600	pA
I_{IO}	Input Offset Current ¹⁾ $T_{MIN} \leq T_{AMB} \leq T_{MAX}$		1	150 300	pA
CMRR	Common-mode Rejection Ratio ($0 < V_{icm} < 10V$)		75		dB
PSRR	Power Supply Rejection Ratio ($2.7 < V_{CC} < 10V$)		80		dB
A_{VD}	Voltage Gain ²⁾		240		dB
V_{ICM}	Input Common Mode Voltage Range (upper rail) $T_{MIN} \leq T_{AMB} \leq T_{MAX}$	10.3 10.0			V
	Input Common Mode Voltage Range (lower rail) $T_{MIN} \leq T_{AMB} \leq T_{MAX}$	-0.3 0.0			
V_{OH}	High Level Output Voltage - $I_{source} = 5mA$ $T_{MIN} \leq T_{AMB} \leq T_{MAX}$	9.6 9.45	9.8		V
V_{OL}	Low Level Output Voltage - $I_{sink} = 5mA$ $T_{MIN} \leq T_{AMB} \leq T_{MAX}$		0.2	0.40 0.55	V
I_{CC}	Supply Current No load, output low No load, output high		7 10	14 16	μA
T_{PLH}	Response Time Low to High ($V_{ic} = 5V$, $C_L = 50pF$) Overdrive = 10mV Overdrive = 100mV		3 0.5		μs
T_{PHL}	Response Time Low to High ($V_{ic} = 5V$, $C_L = 50pF$) Overdrive = 10mV Overdrive = 100mV		4 0.4		μs
T_F	Fall Time ($C_L = 50pF$) Overdrive = 100mV		20		ns
T_R	Rise Time ($C_L = 50pF$) Overdrive = 100mV		20		ns

1) Maximum values include unavoidable inaccuracies of the industrial test.

2) Design evaluation.

3) Limits are 100% production tested at +25°C. Limits over temperature are guaranteed through correlation and by design.

Supply current versus supply voltage
(Output low)

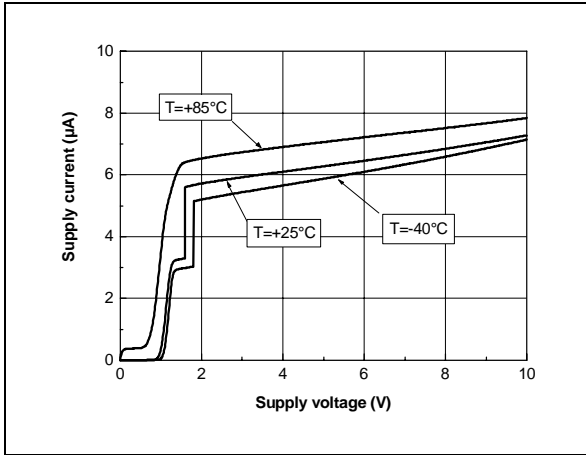

I_{CC} versus output frequency
and V_{ICM} @ $V_{CC}=2.7V$

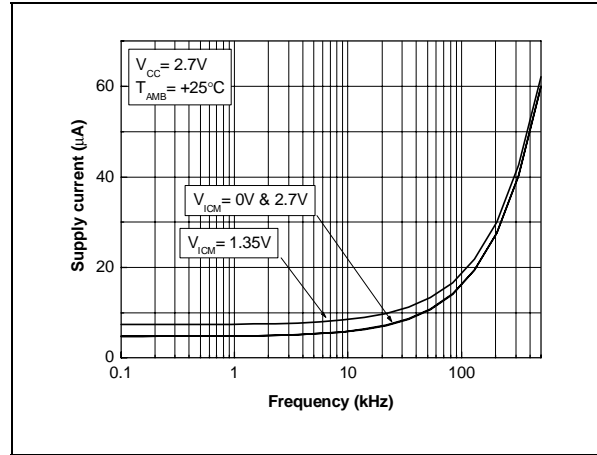

I_{CC} versus frequency and V_{ICM} @ $V_{CC}=5V$

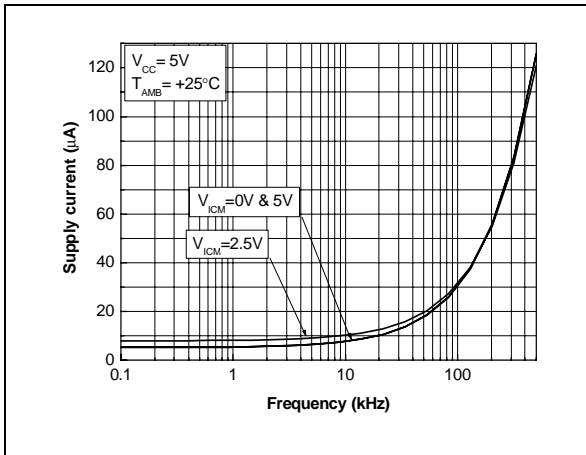

I_{CC} versus frequency and V_{ICM} @ $V_{CC}=10V$

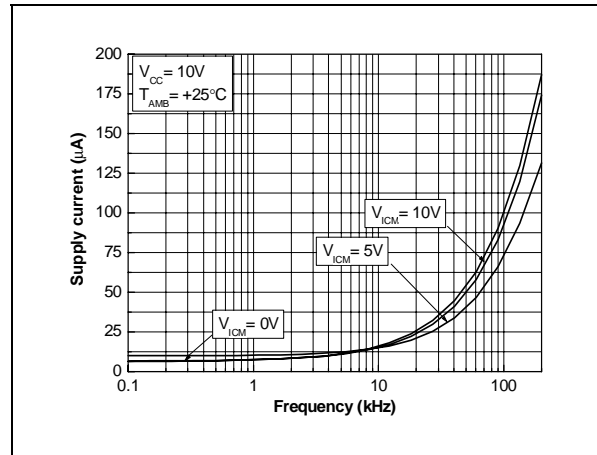

Output sinking current vs Output voltage @
 $V_{CC} = +5V$

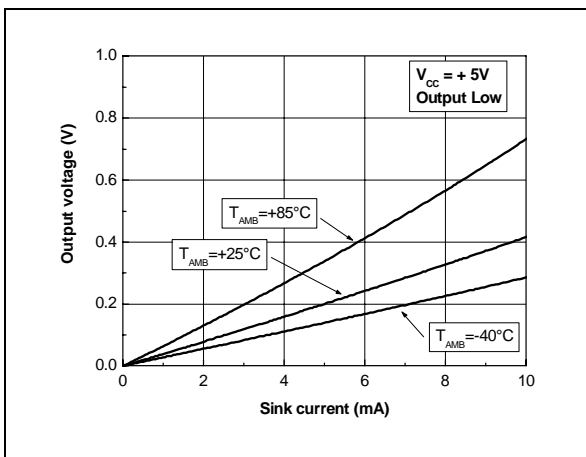

Output sourcing current vs Output voltage @
 $V_{CC} = +5V$

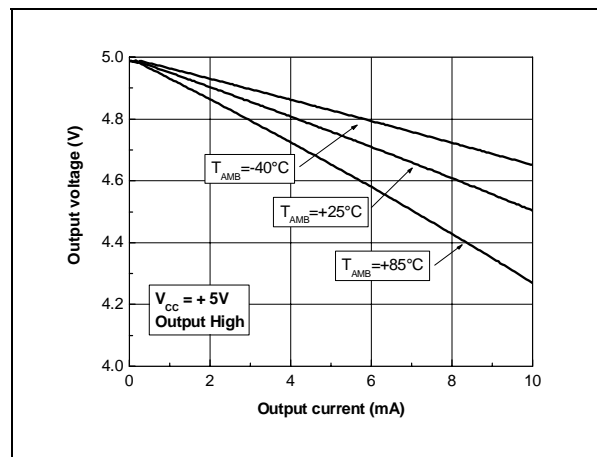

T_{PLH} vs V_{ICM} @ $V_{CC}=10V$ and 10mV overdrive

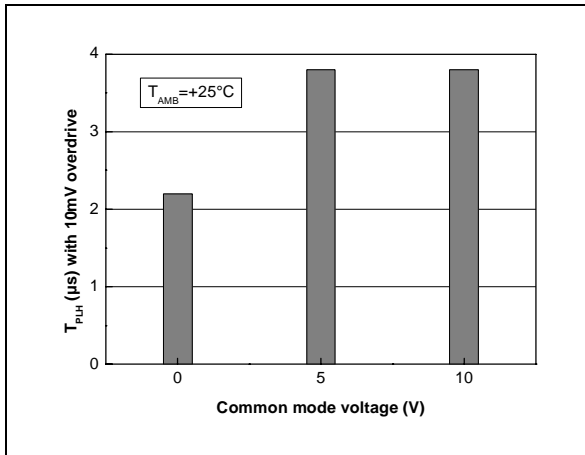

T_{PLH} vs V_{ICM} @ $V_{CC}=10V$ and 100mV overdrive

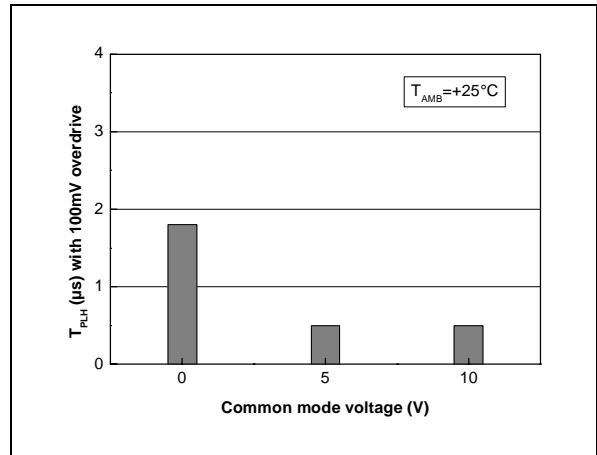

T_{PLH} vs V_{ICM} @ $V_{CC}=5V$ and 10mV overdrive

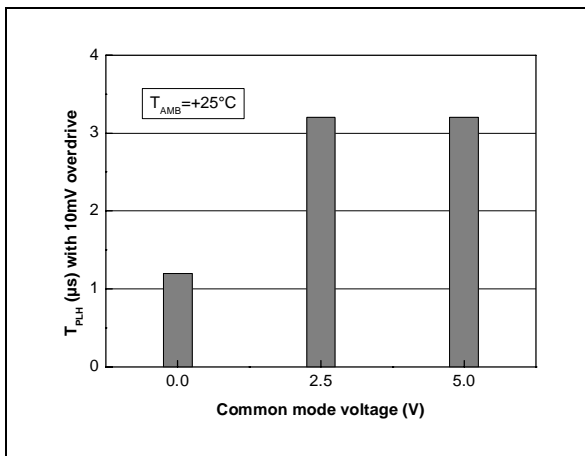

T_{PLH} vs V_{ICM} @ $V_{CC}=5V$ and 100mV overdrive

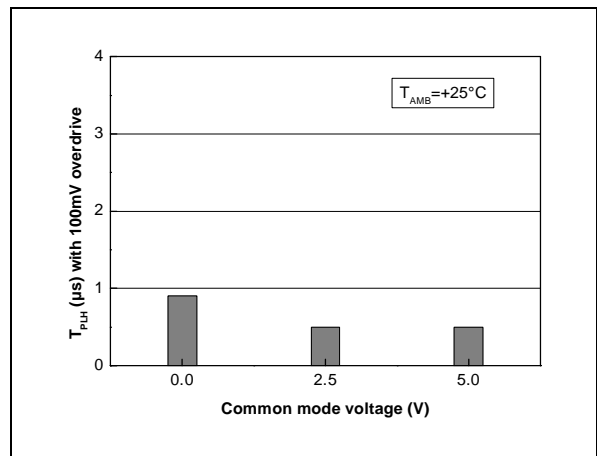

T_{PHL} vs V_{ICM} @ $V_{CC}=10V$ and 10mV overdrive

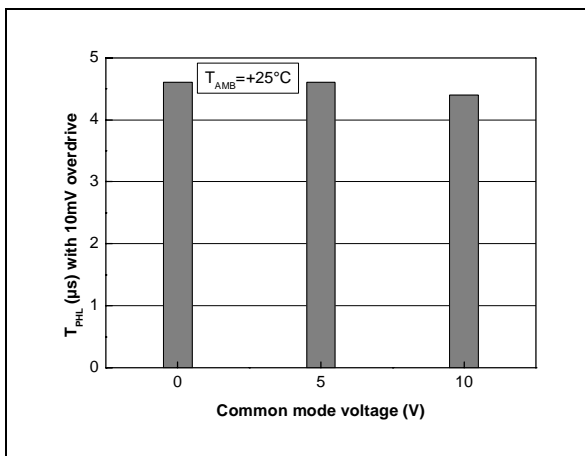

T_{PHL} vs V_{ICM} @ $V_{CC}=10V$ and 100mV overdrive

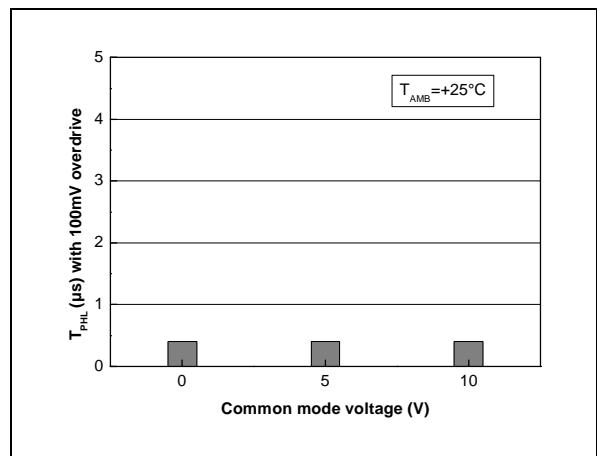

T_{PHL} vs V_{ICM} @ $V_{CC}=5V$ and 10mV overdrive

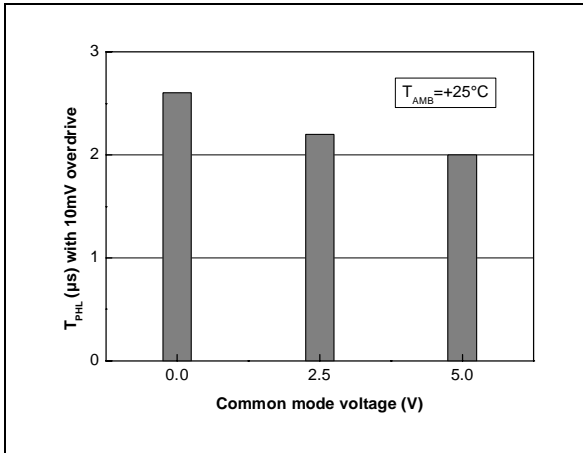

T_{PHL} vs V_{ICM} @ $V_{CC}=5V$ and 100mV overdrive

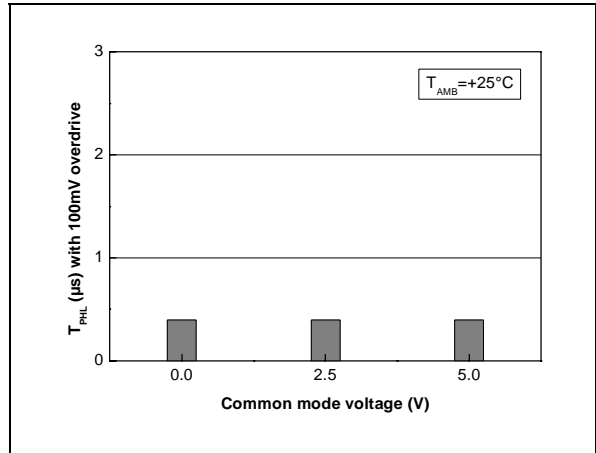

V_{IO} vs V_{ICM} & Temperature @ $V_{CC}=2.7V$

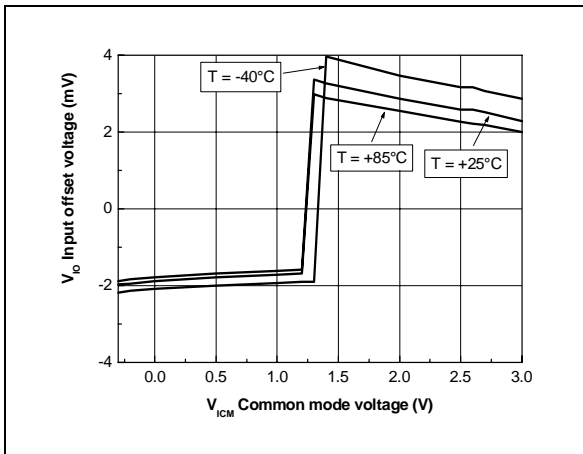

V_{IO} vs V_{ICM} & Temperature @ $V_{CC}=5V$

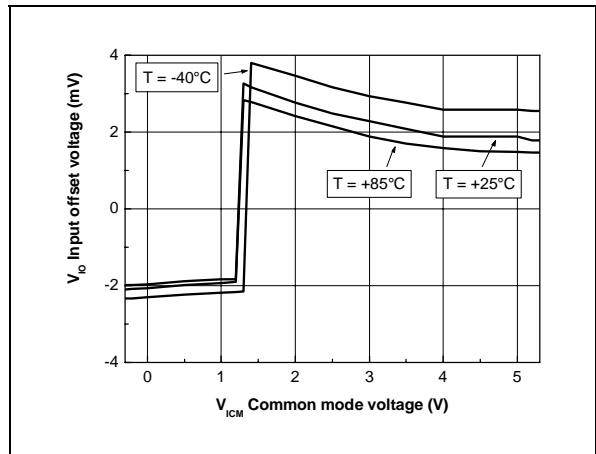

V_{IO} vs V_{ICM} & Temperature @ $V_{CC}=10V$

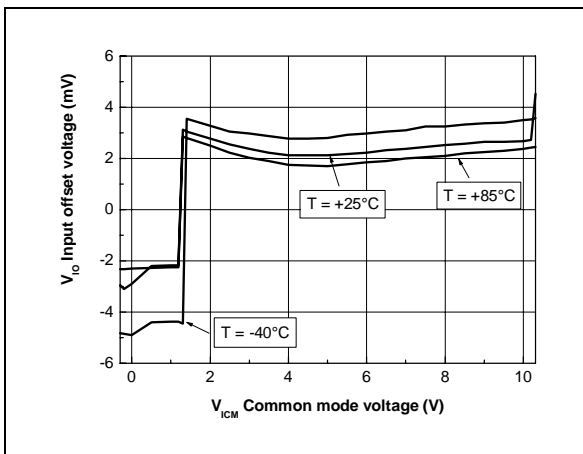

PACKAGE MECHANICAL DATA
5 PINS - TINY PACKAGE (SOT23)

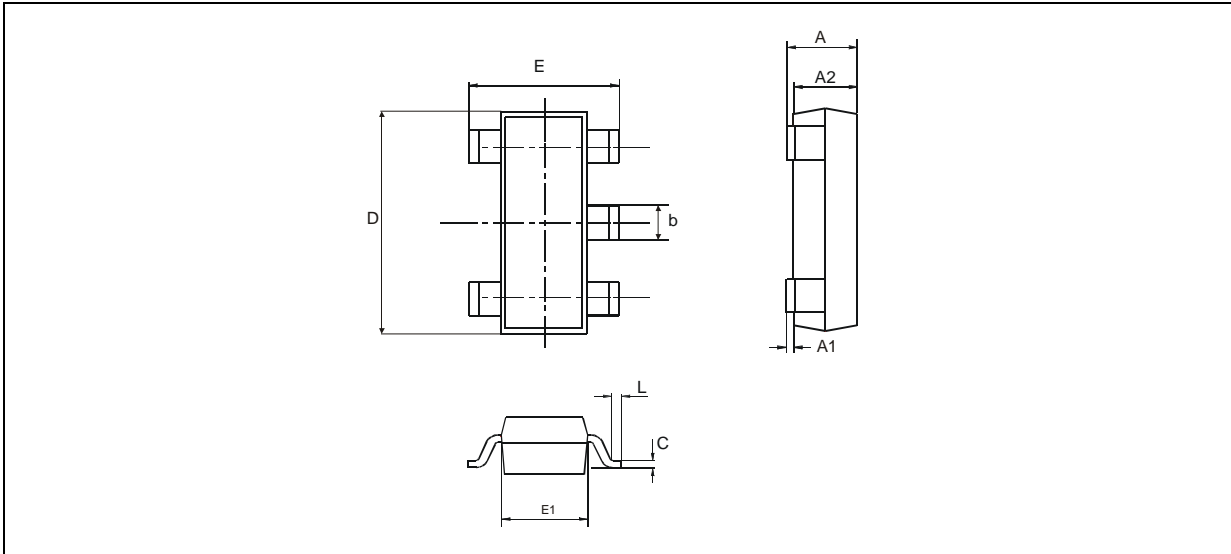

Dimensions	Millimeters			Inches		
	Min.	Typ.	Max.	Min.	Typ.	Max.
A	0.90	1.20	1.45	0.035	0.047	0.057
A1	0		0.15			0.006
A2	0.90	1.05	1.30	0.035	0.041	0.051
B	0.35	0.40	0.50	0.014	0.016	0.020
C	0.09	0.15	0.20	0.004	0.006	0.008
D	2.80	2.90	3.00	0.110	0.114	0.118
D1		1.90			0.075	
e		0.95			0.037	
E	2.60	2.80	3.00	0.102	0.110	0.118
F	1.50	1.60	1.75	0.059	0.063	0.069
L	0.3	0.5	0.60	0.012	0.014	0.024
K	0d		10d	0d		10d

Information furnished is believed to be accurate and reliable. However, STMicroelectronics assumes no responsibility for the consequences of use of such information nor for any infringement of patents or other rights of third parties which may result from its use. No license is granted by implication or otherwise under any patent or patent rights of STMicroelectronics. Specifications mentioned in this publication are subject to change without notice. This publication supersedes and replaces all information previously supplied. STMicroelectronics products are not authorized for use as critical components in life support devices or systems without express written approval of STMicroelectronics.

© The ST logo is a registered trademark of STMicroelectronics

© 2002 STMicroelectronics - Printed in Italy - All Rights Reserved
STMicroelectronics GROUP OF COMPANIES

Australia - Brazil - China - Finland - France - Germany - Hong Kong - India - Italy - Japan - Malaysia - Malta - Morocco
 Singapore - Spain - Sweden - Switzerland - United Kingdom

© <http://www.st.com>



Стандарт Электрон Связь

Мы молодая и активно развивающаяся компания в области поставок электронных компонентов. Мы поставляем электронные компоненты отечественного и импортного производства напрямую от производителей и с крупнейших складов мира.

Благодаря сотрудничеству с мировыми поставщиками мы осуществляем комплексные и плановые поставки широчайшего спектра электронных компонентов.

Собственная эффективная логистика и склад в обеспечивает надежную поставку продукции в точно указанные сроки по всей России.

Мы осуществляем техническую поддержку нашим клиентам и предпродажную проверку качества продукции. На все поставляемые продукты мы предоставляем гарантию .

Осуществляем поставки продукции под контролем ВП МО РФ на предприятия военно-промышленного комплекса России , а также работаем в рамках 275 ФЗ с открытием отдельных счетов в уполномоченном банке. Система менеджмента качества компании соответствует требованиям ГОСТ ISO 9001.

Минимальные сроки поставки, гибкие цены, неограниченный ассортимент и индивидуальный подход к клиентам являются основой для выстраивания долгосрочного и эффективного сотрудничества с предприятиями радиоэлектронной промышленности, предприятиями ВПК и научно-исследовательскими институтами России.

С нами вы становитесь еще успешнее!

Наши контакты:

Телефон: +7 812 627 14 35

Электронная почта: sales@st-electron.ru

Адрес: 198099, Санкт-Петербург,
Промышленная ул, дом № 19, литера Н,
помещение 100-Н Офис 331