

# 4-wire Resistive Touch Screen Controller

## BU21029GUL

### •General Description

Unlike most resistive touch screen controllers, the BU21029GUL 4-wire resistive touch-screen controller can generate data that enables dual touch detection. The Host processor can use this data to detect single and dual point coordinates.

### •Features

- Single and dual touch detection for standard 4-wire resistive touch screens
- I2C-like interface for interfacing with the host processor
- 12-bit resolution
- Single 1.65V to 3.60V supply
- Power on reset
- Auto power down control
- Built-in clock oscillator circuit

### •Key Specifications

■ Power supply voltage	1.65[V]~3.60[V]
■ Temperature range	-20[°C]~85[°C]
■ Standby current	1.0[μA] (Max.)
■ Sleep current	100[μA] (Typ.)
■ Operating current	0.8[mA] (Typ.)
■ Coordinate resolution	12bit

### •Package

VCSP50L2      2.00 mm x 2.00 mm x 0.55(max) mm

### •Applications

- Equipment with built-in user interface for 4-wire resistive touch screen
- Portable information equipment like smart phones, tablets, and PDAs
- Audio-visual equipment like digital still cameras, digital video cameras, and portable TVs
- PCs or peripheral equipment like laptops, touch screen monitors, and printers

### •Typical Application Circuit

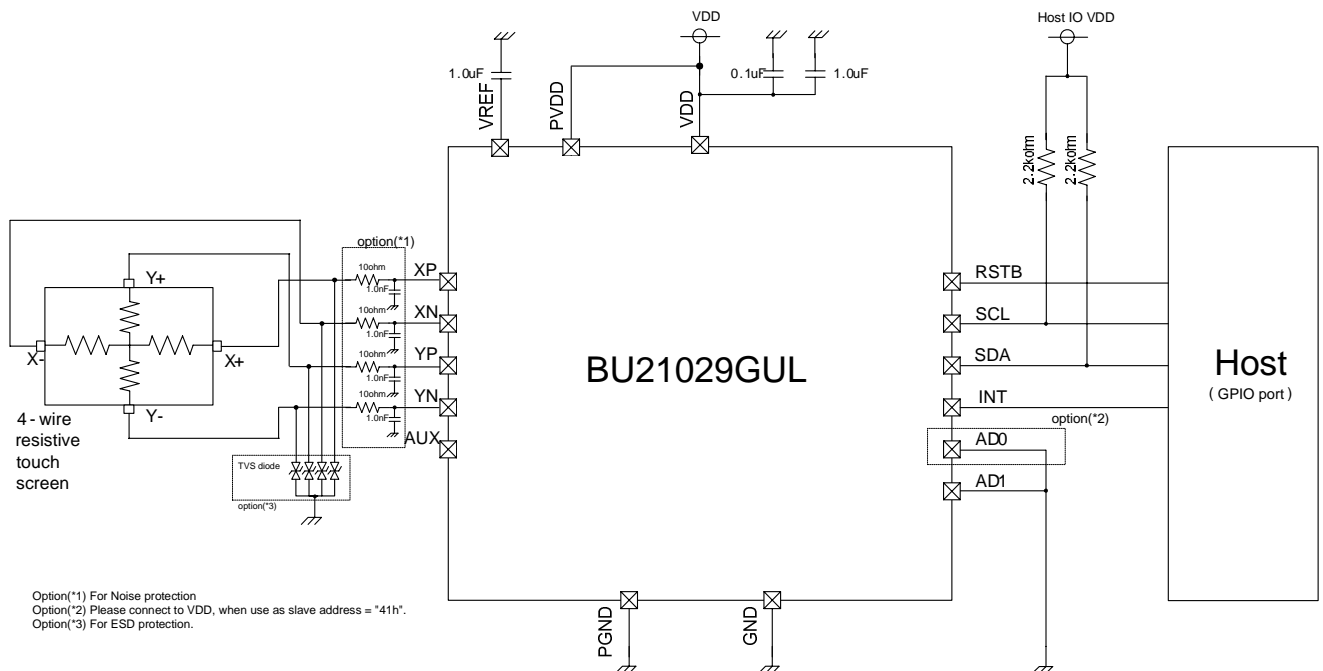

●Pin Configuration

Top View

	1	2	3	4
A	YP	XN	YN	AD0
B	XP	PGND	AD1	SDA
C	PVDD	AUX	RSTB	SCL
D	VREF	GND	VDD	INT

●Pin Description

Pin No	Pin Name	I/O	Description	Equivalent circuit
A1	YP	I/O	YP channel input	D
A2	XN	I/O	XN channel input	D
A3	YN	I/O	YN channel input	D
A4	AD0	I	Slave address input bit0	A
B1	XP	I/O	XP channel input	D
B2	PGND	-	Ground for touch screen drivers	-
B3	AD1	I	Test input(*1)	A
B4	SDA	I/O	Serial data(*2)	C
C1	PVDD	-	Power supply for touch screen drivers.	-
C2	AUX	I	Auxiliary channel input	D
C3	RSTB	I	System reset(*3)	A
C4	SCL	I	Serial clock(*2)	C
D1	VREF	-	Regulator output for control logic.(*4)	-
D2	GND	-	Ground	-
D3	VDD	-	Power supply	-
D4	INT	O	Interrupt output. Pin polarity with active low.	B

(\*1) Connect AD1 to GND.

(\*2) SCL and SDA need a pull-up resistor greater than 2.2kΩ.

(\*3) Connect RSTB to VDD if it will not be controlled.

(\*4) Bypass VREF, DVDD\_IN, DVDD\_OUT to GND with a 1.0uF capacitor and do not connect to the supply.

●Equivalent Circuit

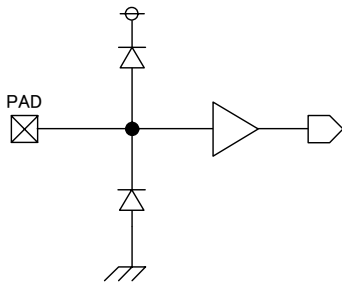

Figure A.

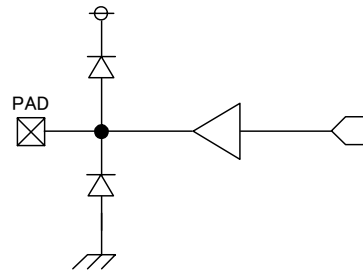

Figure B.

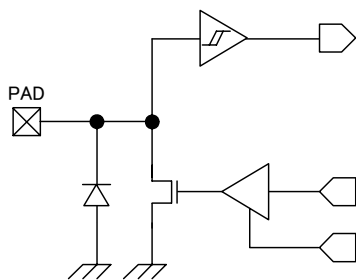

Figure C.

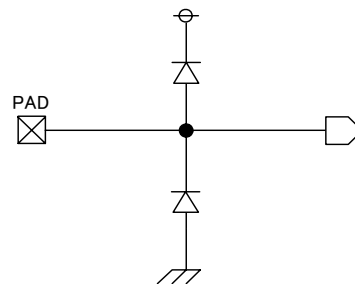
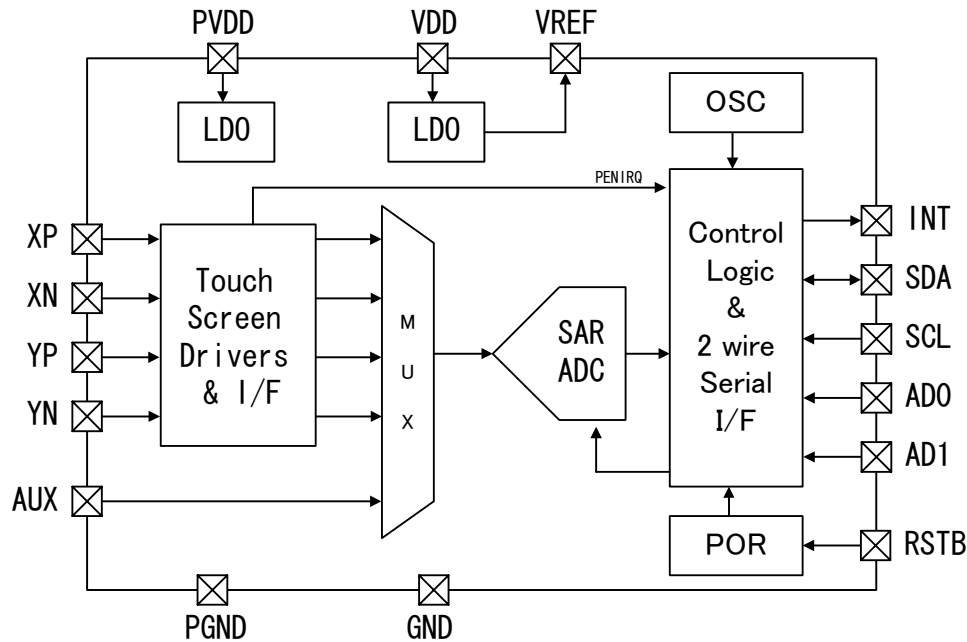

Figure D.

### ●Block Diagram



### ●OVERVIEW

BU21029GUL is a controller for 4-wire resistive touch screens. It has built-in 12-bit SAR A/D converter, clock oscillator, power on reset circuit, and LDO regulator for internal blocks and operates with 1.65-3.60V single power supply. Aside from being able to detect single point coordinates and touch pressure like existing 4-wire resistive touch screen controllers can, it can also detect dual coordinates by generating data based on the prearranged touch screen parameters.

Communication between BU21029GUL controller and the host processor uses 2-wire serial interface. The BU21029GUL, being the I2C slave device, is controlled by the host processor by writing to its registers. This way, the host processor sets whether the touch screen controller operates under command control mode or under automatic control mode. In automatic control mode, the host processor reads the touch data saved by the controller in its internal registers at any time.

#### Preprocess

A/D conversion is continuously done for several times in one driving time. Data is median average processed; meaning data is sorted and calculation that takes the average from the center of the sorted data is performed.

#### Interrupt control

The BU21029GUL sends an interrupt signal to the host processor through INT, an active-low pin, whenever it detects touch on the screen. In automatic control mode, this happens after the scan of the first touch is completed.

#### 2-point detection function

The 2-point detection function of BU21029GUL can be used by calibrating the circuit for 2-point detection based on the inherent panel perimeters (registers 0x3, 0x4). Since the characteristics of each touch panel differ significantly, it is necessary for the host processor to execute the calibration of parameters to match the 2-point detection circuit of BU21029GUL with every touch panel.

#### Power control

After a conversion function has been completed, the BU21029GUL automatically powers down in order to reduce current consumption. In automatic control mode, scanning restarts automatically from power down when the touch screen is operated.

#### Power on reset

BU21029GUL has built-in power-on-reset circuit. If the host processor will not be used to control RSTB pin, RSTB pin can be shorted to VDD. This way, the registers of BU21029GUL initialize upon power-on.

### ●ABSOLUTE MAXIMUM RATINGS

Parameter	Symbol	Rating	Unit	Conditions
Power supply voltage	V <sub>DD</sub>	-0.3 to 4.5	V	
Power supply voltage for touch screen	PV <sub>DD</sub>	-0.3 to 4.5	V	
Digital input voltage	V <sub>IN1</sub>	-0.3 to V <sub>DD</sub> +0.3	V	AD0,AD1,SDA, SCL and RSTB
AUX input voltage	V <sub>IN2</sub>	GND-0.3 to 2.5	V	AUX
Voltage input to touch screen Interface	V <sub>IN3</sub>	GND-0.3 to 2.5	V	XP,YP,XN and YN
Package power dissipation	P <sub>d</sub>	0.75	W	(*1)
Storage temperature range	T <sub>stg</sub>	-50 to 125	°C	

(\*1) Ambient temperature reduces the permissible loss by 7.50mW/°C if above 25°C Celsius.

Operating the IC over the absolute maximum ratings may damage the IC. The damage can either be a short circuit between pins or an open circuit between pins and the internal circuitry. Therefore, it is important to consider circuit protection measures, such as adding a fuse, in case the IC is operated over the absolute maximum ratings.

### ●RECOMMENDED OPERATING CONDITIONS

Parameter	Symbol	Rating			Unit	Conditions
		Min	Typ	Max		
Power supply voltage	V <sub>DD</sub>	1.65	3.00	3.60	V	
Power supply voltage for touch screen	PV <sub>DD</sub>	1.65	-	V <sub>DD</sub>	V	V <sub>DD</sub> ≥ PV <sub>DD</sub>
Operating temperature	T <sub>opr</sub>	-20	25	85	°C	

### ●ELECTRICAL CHARACTERISTICS (T<sub>a</sub>=25°C, V<sub>DD</sub>=PV<sub>DD</sub>=3.00V, GND=0.00V, unless otherwise noted)

Parameter	Symbol	Rating			Unit	Conditions
		Min	Typ	Max		
Low-level input voltage	V <sub>IL</sub>	GND-0.3	-	V <sub>DD</sub> *0.2	V	AD0,AD1,SDA,SCL and RSTB
High-level input voltage	V <sub>IH</sub>	V <sub>DD</sub> *0.8	-	V <sub>DD</sub> +0.3	V	AD0,AD1,SDA,SCL and RSTB
Low-level output voltage1	V <sub>OL1</sub>	-	-	GND+0.4	V	SDA(IL=5mA),INT(IL=3mA), V <sub>DD</sub> ≥ 2.0V
Low-level output voltage2	V <sub>OL2</sub>	-	-	V <sub>DD</sub> *0.2	V	SDA(IL=5mA),INT(IL=3mA), V <sub>DD</sub> < 2.0V
High-level output voltage1	V <sub>OH1</sub>	V <sub>DD</sub> -0.4	-	-	V	INT,IL=-3mA V <sub>DD</sub> ≥ 2.0V
High-level output voltage2	V <sub>OH2</sub>	V <sub>DD</sub> *0.8	-	-	V	INT,IL=-3mA V <sub>DD</sub> < 2.0V
Standby current	I <sub>st</sub>	-	-	1.0	uA	RSTB=L
Sleep current	I <sub>slp</sub>	-	100	200	uA	RSTB=H
Active current	I <sub>act</sub>	-	0.8	2.0	mA	No Load
Resolution	A <sub>d</sub>	12			Bit	
Differential non-linearity error	DNL	-3	-	+3	LSB	
Integrate non-linearity error	INL	-5	-	+5	LSB	
Switch on-resistance	R <sub>ON</sub>	0.5	5.0	20.0	Ω	XP,XN,YP and YN

### ●Host interface AC timing

The slave address for 2-wire serial interface is selectable from "40h" or "41h" by "AD0" input.

AD0 = "L" : Slave Address = 40h

AD0 = "H" : Slave Address = 41h

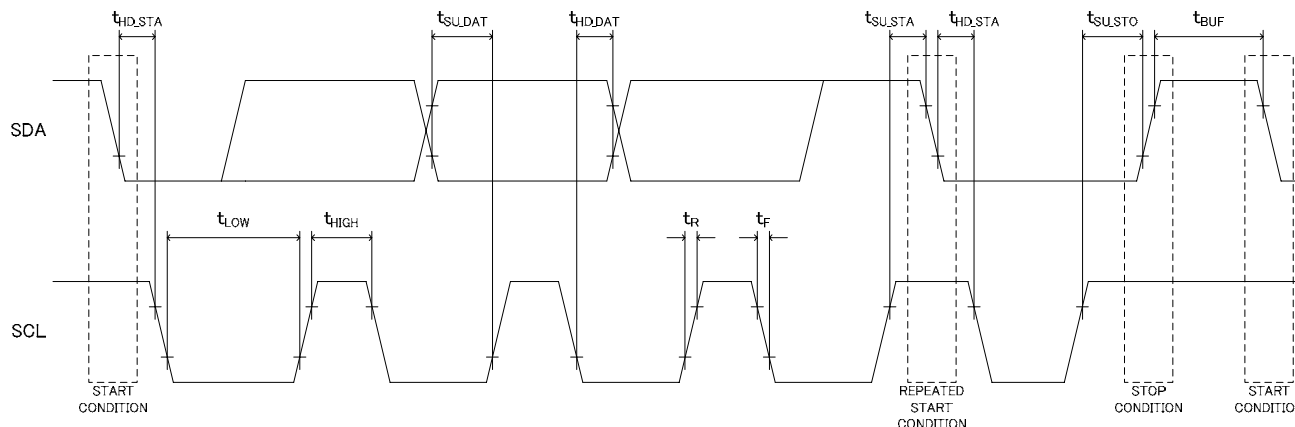

2-wire serial I/F AC timing characteristics ( $T_a=25^\circ\text{C}$ ,  $V_{DD}=PV_{DD}=3.00\text{V}$ ,  $GND=0.00\text{V}$ , unless otherwise noted)

PARAMETER	SYMBOL	RATING			UNIT	CONDITION
		MIN.	TYP.	MAX.		
SCL clock frequency	$f_{SCL}$	0	-	400	kHz	
Hold time for (repeated) START condition	$t_{HD\_STA}$	0.6	-	-	us	
Low period of SCL	$t_{LOW}$	1.3	-	-	us	
High period of SCL	$t_{HIGH}$	0.6	-	-	us	
Setup time for repeated START condition	$t_{SU\_STA}$	0.6	-	-	us	
Data hold time	$t_{HD\_DAT}$	0	-	0.9	us	
Data setup time	$t_{SU\_DAT}$	0.1	-	-	us	
Rise time for both SCL and SDA	$t_R$	20	-	300	ns	
Fall time for both SCL and SDA	$t_F$	20	-	300	ns	
Setup time for STOP condition	$t_{SU\_STO}$	0.6	-	-	us	
Bus free time between a STOP and START condition	$t_{BUF}$	1.3	-	-	us	

### ●Host Interface Specification

The BU21029GUL controller operates as an I2C slave device. At the start of the communication, it receives an address byte transmitted by the host processor and then sends back an acknowledgement byte. The host processor can transmit a command to execute conversion or to access registers only after receiving the acknowledgement for the address byte. Communication ends when BU21029GUL receives a stop command.

### ●Address byte

On the address byte, the slave address for 2-wire interface is written on the upper 7 bits and the READ/WRITE bit is written on the last bit. The upper six bits of the slave address are fixed to "100000" while the last bit is determined by the "AD0" input.

Table 1. Serial Interface Slave Address Byte

MSB D7	D6	D5	D4	D3	D2	D1	LSB D0
1	0	0	0	0	0	A0	R/W

Bit D1: A0

Slave address bit0 (AD0)

Bit D0: R/W

1=read (reading data)

0=write (writing data)

### ●Command byte

The operation of BU21029GUL is dictated by the command byte. The host processor sets CID (D7) to 1 for conversion function or to 0 for register access.

Table 2. Serial Interface Command Byte 1(CID=1)

MSB D7	D6	D5	D4	D3	D2	D1	LSB D0
1	CF				CMSK	PDM	STP

Bit D7: Command Byte ID

1= Command Byte 1(starts the conversion function determined by CF (Bit D6-D3))

Bits D6-D4: CF

Conversion function is selected as detailed below.

Table 3. BU21029GUL Conversion Function List

CF	Description
0x0	Touch screen scan function: X, Y, Z1 and Z2 coordinates are converted.
0x1	NOP
0x2	Auxiliary input is converted.
0x3	Clipping value is changed.
0x4	Free scan function: Status of Driver and input of A/D is assigned by the Host.
0x5	Calibration: Parameters for dual touch detection are calibrated.
0x6	NOP
0x7	NOP
0x8	X+, X- driver status
0x9	Y+, Y- driver status
0xA	Y+, X- driver status
0xB	NOP
0xC	Touch screen scan function: X coordinate is converted.
0xD	Touch screen scan function: Y coordinate is converted.
0xE	Touch screen scan function: Z1 and Z2 coordinates are converted.
0xF	Reserved

CF= 0000 : Automatic scan

This makes BU21029GUL periodically and automatically scan the screen and convert data upon detecting touch. When the device cannot detect touch, it stops and stays in power down state until it detects the next pen-down. The order of scan process is Z1, Z2, X and Y.

CF= 0001, 0110, 0111, 1011

No operation. ("PDM" and "STP" is valid.)

CF = 0010

This converts the voltage impressed to AUX. After the conversion has been completed, the device is powered down according to the PDM setting.

CF= 0100 : Free scan mode

In Free Scan Mode, the driver state (X+, X-, Y+, Y-) and conversion input (X+, X-, Y+, Y-, AUX) can be selected through register settings.

CF= 0101 : Calibration

This calibrates the parameters for dual touch detection. To activate the dual touch function, setting of CF to 0101 and execution of the calibration command should be done after power-on.

CF= 1000, 1001, 1010: Drivers status control

This activates the analog circuit and panel driver corresponding to each command. BU21029GUL remains in this state until it receives another SCAN instruction or until "STP" is set.

CF= 1100, 1101, 1110: Manual scan

This converts coordinates that correspond to each command. BU21029GUL goes to power-down state after a complete conversion if "PDM" is set to "0". Otherwise, it stays at power-on state.

CF =0011, 1111

Reserved.

Bit D2 : CMSK

0=Executes convert function.

1=Reads the convert result

Bit D1 : PDM

Power Down Control

0= Powers down the device after converter function stops

1= Keeps power on after converter function stops

Bit D0 : STP

1= Aborts currently running conversion and changes the state to power-down (STP is automatically set to "0".)

Table 4. Serial interface Command Byte 0(CID=0)

MSB							LSB
D7	D6	D5	D4	D3	D2	D1	D0
0	ADDR[3:0]				PAGE	SWRST	STP

Bit D7: Command Byte ID

0=Reads/writes on data register addresses specified by ADDR (Bit D6-D3).

Bits D6-D3: ADDR

D2: PAGE

Register addresses that "ADDR" and "PAGE" can access are listed below.

Table 5. BU21029GUL Register Map

PAGE	ADDR	INI	7	6	5	4	3	2	1	0	
0	0x0	0x20	RSV0	RSV0	CALIB	INTRM	RSV0	RSV0	RSV0	RSV0	
	0x1	0xA6	MAV	AVE			-	SMPL			
	0x2	0x04	INTVL_TIME				TIME_ST_ADC				
	0x3	0x10	EVR_X								
	0x4	0x10	EVR_Y								
	0x5	0x10	EVR_XY								
	0x6	0x00	RSV0								
	0x7	0x00	RSV0								
	0x8	0x00	-	-	-	-	RSV0				
	0x9	0x0F	-	-	-	PIMIR_X					
	0xA	0x0F	-	-	-	PIMIR_Y					
	0xB	0x72	RM8	STRETCH	PU90K	DUAL	PIDAC_OFS				
	0xC	0x00	-	PVDD				-	AVDD		
	0xD	0x00	TEST	AUTO	PDM	-	BUSY	ACTIVE	CALIB DONE	TOUCH	
	0xE	0x02	HW_IDH								
	0xF	0x29	HW_IDL								
1	0x0	0x00	SW_YP_ POW	SW_YP_ GND	SW_YN_ POW	SW_YN_ GND	SW_XP_ POW	SW_XP_ GND	SW_XN_ POW	SW_XN_ GND	
	0x1	0x00	RSV0	RSV0	RSV0	SW_AUX	SW_YPM	SW_YNM	SW_XPM	SW_XNM	
	0x2-0x4	-	Reserved								
	0x5	0x03	RSV0	DPRM	RSV0	RSV0	RSV0	RSV0	RSV1	RSV1	
	0x6-0xF	-	Reserved								

(\*1) RSV0 must be set to 0.

(\*2) RSV1 must be set to 1

Bit D1: SWRST

1= Initializes all registers, stops all operations, and changes state to power-down (SWRST is automatically set "0".)

Bit D0: STP

1= Aborts currently running conversion and changes the state to power-down (STP is automatically set to "0".)



●WRITE CYCLE

The host first sends an address byte to the BU21029GUL controller. This address byte is composed of the 7-bit slave byte on the upper seven bits and the Read/Write bit on the LSB. If the controller receives a valid address byte, it issues an acknowledgement. The host processor can transmit a command only after receiving the acknowledgement for the address byte from the controller. The controller then sends back another acknowledgement, allowing the host to continually send write data or issue a STOP command.

Write : Convert function

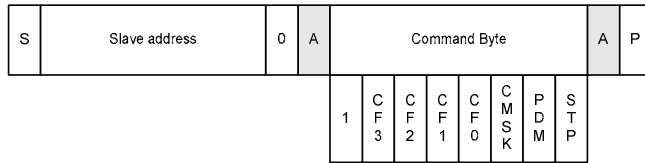

Write : Register write

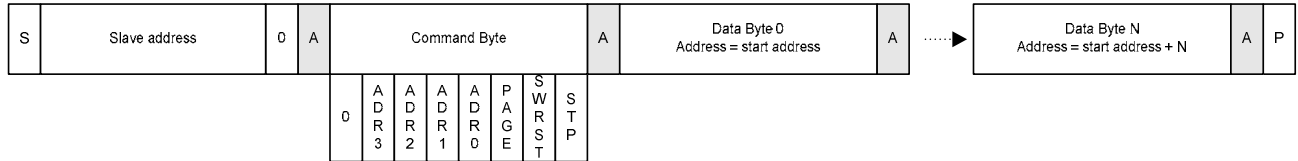

S : START condition    P : STOP condition    A : ACK    N : NACK

Figure 1. Write Protocol

●READ CYCLE

The READ bit is the LSB of the address byte. When read mode is selected, BU21029GUL sends back the data byte followed by an acknowledgement to the host. The data sent back is either the conversion result or the register value, depending on the last command byte received by BU21029GUL. The host needs to resend the conversion command with setting "CMSK=1" if it has read the register value before reading the conversion result. BU21029GUL sends the next data byte after it has received an acknowledgement from the host for the previous data byte. Upon receiving the last data byte, the host finishes read access by issuing a START (or STOP) commands followed by NACK (not acknowledged) command.

Read cycle

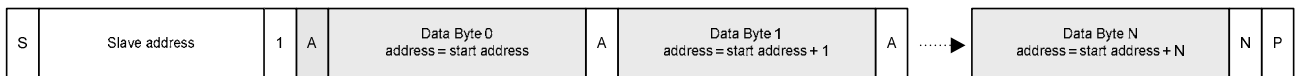

S : START condition    P : STOP condition    A : ACK    N : NACK

Figure 2. Read Protocol

●SCL STRETCH

If the host reads the conversion result while conversion is ongoing, BU21029GUL notifies it through the SCL\_STRETCH function. (\*1) SCL\_STRECH is released when conversion function is finished.

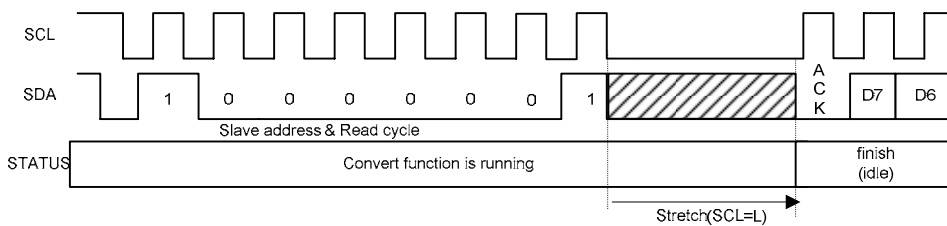
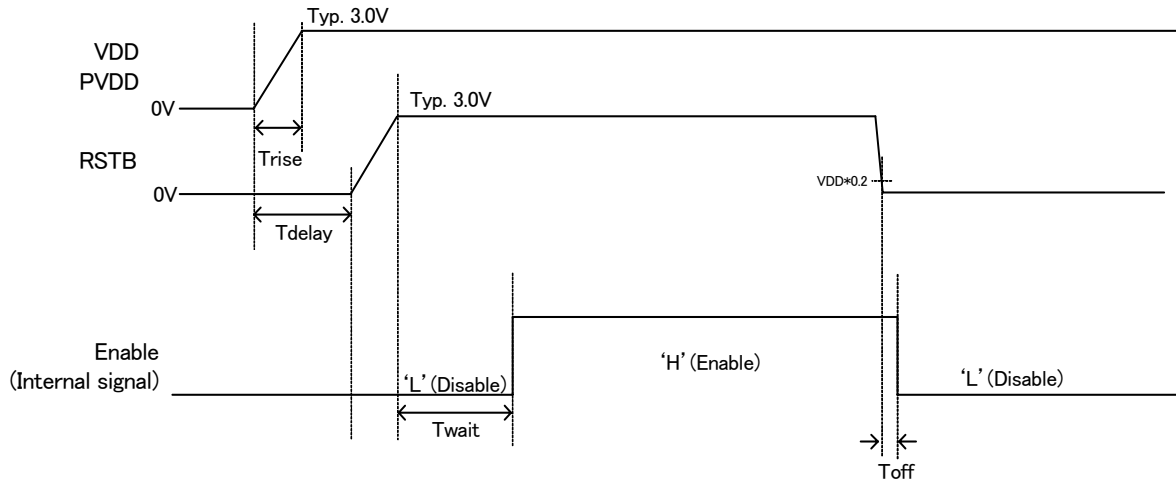

Figure 3. SCL Stretch Timing

**•Power Supply and Reset Timing Specification**

When pin RSTB is low, BU21029GUL is in standby mode and the host cannot communicate with it. Once pin RSTB is set high, BU21029GUL will go to idle state after the time define by Tdelay has passed and will be able to communicate with the host processor again.

Pin RSTB can be connected to the power supply through the power-on-reset circuit.



Power-on-reset AC Timing Characteristics (Ta=25°C, VDD=PVDD=3.00V, GND=0.00V, unless otherwise noted)

Parameter	Symbol	Rating			Unit	Condition
		MIN	TYP	MAX		
VDD rise time	Trise	0.01	-	10	ms	
RSTB delay time	Tdelay	0	-	-	ms	
Enable delay time	Twait	-	-	1	ms	VREF, DVDD_IN, DVDD_OUT, Cload=1.0uF
RSTB time	Toff	1	-	30	us	VREF, DVDD_IN, DVDD_OUT, Cload=1.0uF

### •Specification of Touch Detection

BU21029GUL executes its touch detection function by outputting an interrupt signal at pin INT once it is able to detect touch. The circuit diagram of the touch detection function is shown on the following figure.

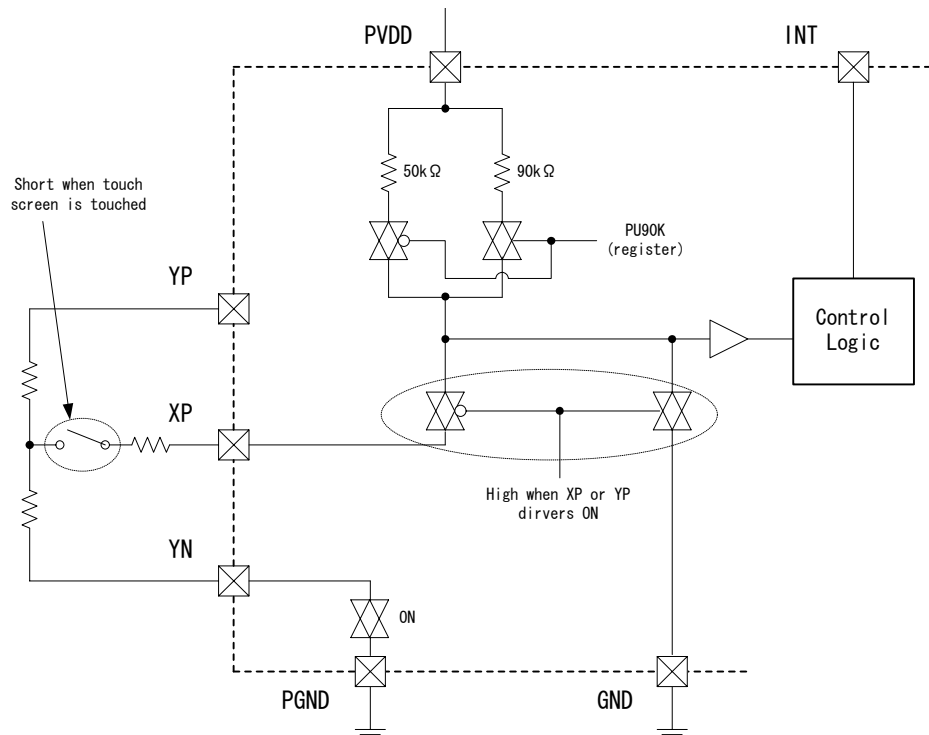

Figure 4. Touch detection circuit

When the touch panel is connected to the panel interface terminals (XP, XN, YP, YN), pin XP is connected to PVDD through an internal pull-up resistor inside the IC and pin YN is connected to PGND. During a no-touch state, BU21029GUL will be on standby. During this time, INT outputs "H" through an internal pull-up resistor. Since pins XP and YN are connected to the touch screen through contact resistance, the resistance ratio of the internal pull-up resistance and the touch screen resistance is able to detect the voltage drop at pin XP whenever the screen is touched. This results to an "L" output at INT.

When touch is detected and pins XP and YP is put to drive state by each scanning operation, the internal pull-up resistance is disconnected from pin XP and the output of pin INT is held at "L".

●Control Flow Chart

BU21029GUL has two operation modes, the command mode, wherein the device operates under the control of the host processor, and auto mode, wherein the device operates by automatic control.

In order to use two-point detection, it is necessary to calibrate the circuit for this function by setting the correct state of registers for panel perimeters (register Addr.0x3, 0x4). Calibration is performed by transmitting the command CF=0101 from the host processor. Take note that each register should be initialized after power on. Moreover, for two-point detection, the interrupt signal from the IC should be enabled after performing parameter calibration.

Table 6. The BU21029GUL Power-on Sequence

step	state	operation
1	Power-on	Power supply is turned on and reset is issued Disable (mask) interruption of the BU21029GUL is set.
2	initialization 1 (For 2 points detection only)	After the waiting time from the issuance of reset, each register of BU21029GUL is initialized by the host processor via the I2C bus.
3	initialization 2 (For 2 points detection only)	The host processor checks if the screen is touched though the INT pin or the status register of BU21029GUL. This step is repeated until touch is detected.
4	initialization 3 (For Auto mode only)	The host processor transmits the calibration command (CF=0101) via the I2C bus.
5		BU21029GUL executes calibration of the two-point detection parameters and sets CALIB_DONE status register to 1.
6		The host stays in stand by state until a fixed period of time or until the CALIB_DONE bit is turned on.
7	initialization 3 (For Auto mode only)	For auto mode control, the host processor transmit the SCAN-XYZ command via the i2C bus. For command control mode, this step is skipped.
8	Normal (finish)	If the host processor receives an interrupt signal from BU21029GUL, it executes the other process. If not, it stays idle until an interrupt signal is detected.

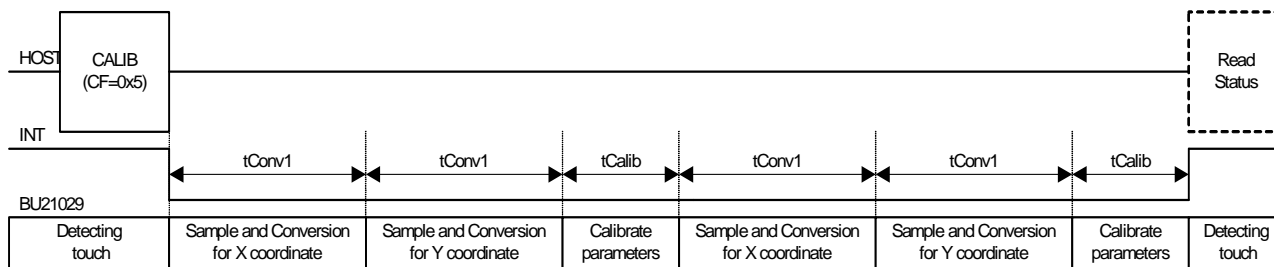

Figure 5. Calibration Flow

- tPON = 710us
- tDLY1 = 1.5us
- tADC = 18us
- tDLY2 = 1.0us
- tTIME\_ST\_ADC = register (addr.0x2)
- tSMPL = register (addr.0x1)
  
- tConv1 = tPON + tDLY1 + (tTIME\_ST\_ADC + (tADC \* tSMPL) \* 2 + tDLY2)
- tCalib = 1 internal clock

(\*1) Even if the part with dashed lines is not performed, read status does not influence the operation.  
 (\*2) Except the first one, tPON(s) is always zero.

### ●Command Mode

In Command Mode, BU21029GUL operates totally under the control of the host processor. In order to take touch data, the host processor needs to control BU21029GUL when there is touch pressure. Since it is necessary for the host processor to issue a command in order to get data, the processing of a host interface in between the presence of touch pressure becomes more active compared with the auto system.

Table 7. Command Method Sequence

touch screen	operation
not touched	The BU21029GUL is in idle state(power down). The host processor operates the other process or stays in the idle state.
touched	The BU21029GUL detects a touch and transmits interrupt signal to the host processor.
	The host processor detects a disabled interrupt signal from the BU21029GUL.
	The host processor transmits the command for X data conversion via I2C bus.
	The BU21029GUL turns on the X drivers and makes the X-axis of the touch screen turn on the power.
	The BU21029GUL converts the X data from the touch screen and transmits via I2C bus.
	The host processor receives the center data and the 2-point data (total of 4 bytes).
	If there is no 2-point detection, only the center data (2 bytes) is received. if the host processor needs 2 or more data by filter processing etc., it repeats steps 4~7.
	The host processor transmit command of Y data conversion via I2C bus.
	After the BU21029GUL turns off the X drivers, it turns on the Y drivers and makes the Y-axis of the touch screen turn on the power.
	The BU21029GUL converts the Y data from the touch screen ad transmits via I2C bus.
	The host processor receives the center data, the 2-point data, and ghost data (total of 6 bytes).
	If there is no 2-point detection, only the center data (2 bytes) is received. if the host processor needs 2 or more data by filter processing etc., it repeats steps 8~11.
	The host processor transmits the command for Z data conversion via I2C bus.
	After the BU21029GUL turns off the Y drivers, it turns on the Z drivers(*1) and makes the Z-axis of the touch screen turn on the electricity.
	The BU21029GUL converts the Z data from the touch screen ad transmits via I2C bus.
	The host processor receives the Z data (total of 4 bytes). if the host processor needs 2 or more data by filter processing etc., it repeats steps 12~15.
The host processor calculates all the data and coverts them into touch coordinates.	
The host processor checks the touch pressure from the INT pin or the status register of the BU21029GUL. Steps 4~16 are repeated when there is touch pressure.	
not touched	Return to step 1.

(\*1) Z driver: YP=VDD, XN=GND state

(\*2) Refer to the dual coordinate conversion in p. 17 for the conversion of coordinates from read data.

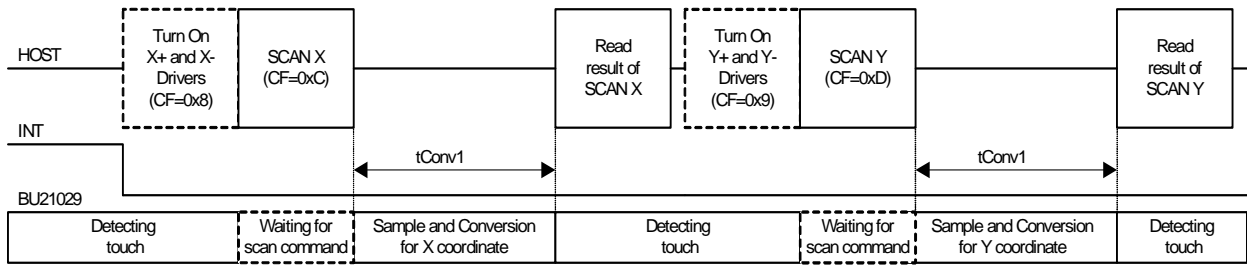

Figure 6. Touch Screen Scan Flow 1 (X and Y scan)

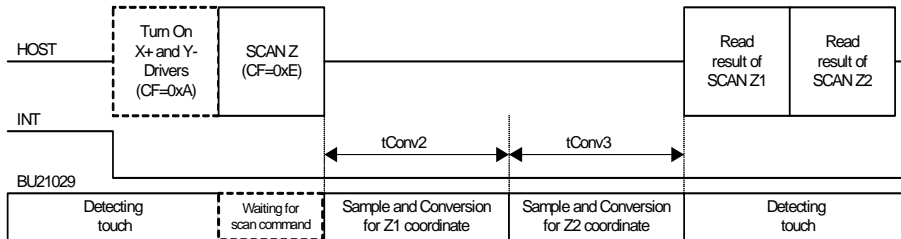

Figure 7. Touch screen scan flow 2 (Z1 and Z2 scan)

tPON = 710us  
 tDLY1 = 1.5us  
 tADC = 18us  
 tDLY2 = 1.0us  
 tTIME\_ST\_ADC = register (addr.0x2)  
 tSMPL = register (addr.0x1)

tConv1 = tPON + tDLY1 + (tTIME\_ST\_ADC + (tADC \* tSMPL) \* 2 + tDLY2)  
 tConv2 = tPON + tDLY1 + tTIME\_ST\_ADC + (tADC \* tSMPL) + tDLY2  
 tConv3 = tDLY1 + (tADC \* tSMPL) + tDLY2

(\*1) Time is calculated with the oscillating frequency of the internal OSC at 8MHz.  
 (\*2) In case PDM=1, tPON(s) is set to zero except for the first one.  
 (\*3) The dashed part is required only when apply time set for a panel is more than TIME\_ST\_ADC.

**Auto Mode**

In Auto Mode, BU21029GUL automatically takes all detected touch and pressure data. An interrupt signal for the 1st data taken is transmitted after detection of touch pressure has been completed. Since BU21029GUL automatically takes data whenever touch pressure is detected, the host processor does not need to control the touch screen.

When operating in this mode, there is a possibility for touch detection to stop due to touch screen chattering noise, power supply noise, etc. Thus, the host processor should periodically refresh BU21029GUL by transmitting the command CF=0000.

Auto Mode of operation starts when SCAN-XYZ (CF=0000) is received from the host processor. The INT pin is not concerned with any touch state. It is set to "H" until the 1st touch data from the start of operation is acquired.

Table 8. Auto Method Sequence

step	touch screen	operation
1	not touched	The BU21029GUL is in idle state(power down). The host processor operates the other process or keeps the idle state.
2	touched	The BU21029GUL detects touch and turns on Z drivers(*1).
3		The BU21029GUL converts the Z data from the touch screen and saves the result temporarily.
4		After the BU21029GUL turns off the Z drivers, it turns on the X drivers and makes the X-axis of the touch screen turn on power.
5		The BU21029GUL converts the X data from the touch screen and saves the result temporarily.
6		After the BU21029GUL turns off the X drivers, it turns on the Y drivers and makes the Y-axis of the touch screen turn on power.
7		The BU21029GUL converts the Y data from the touch screen and saves the result temporarily.
8		The BU21029GUL checks touch pressure. When touch pressure is detected, all conversion results are copied to the internal registers of the BU21029GUL and interrupt signal is transmitted to the host processor. Then the process returns to step 2. When no touch pressure is detected, all conversion result are cancelled and transmission of an
9		The host processor does the mask of the interruption after receiving an interrupt signal.
10	The host processor receives all touch and 2-point data (total of 14 bytes) via I2C bus and converts to them to touch coordinates.(*2) When not detecting 2 points, only touch data (8 bytes) is received.	
11	The host processor checks the touch pressure from the INT pin or status register of BU21029GUL. It returns to step 10 when there is touch pressure and to step 1 when there is none.	

(\*1) Z driver: YP=VDD, XN=GND state

(\*2) Refer to the dual coordinate's conversion (p. 17) for the conversion of coordinates from read data.

(\*3) The host processor can refresh at any timing, and recommended timing is in sequence with step 1.

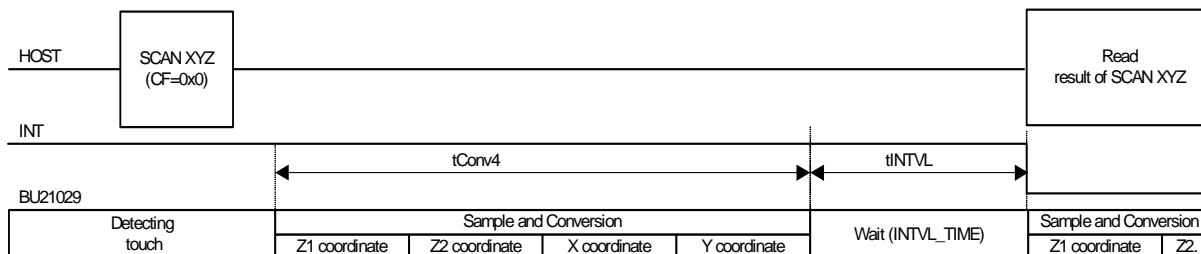

Figure 8. Touch screen scan flow 3 (XYZ scan)

tPON = 710us

tDLY1 = 1.5us

tADC = 18us

tDLY2 = 1.0us

tTIME\_ST\_ADC = register (addr.0x2)

tINTVL = register (addr.0x2)

tSMPL = register (addr.0x1)

$$tConv4 = tPON + tDLY1 + (tTIME\_ST\_ADC + (tADC * tSMPL) * 2 + tDLY2) * 3$$

(\*1) Time is calculated with the oscillating frequency of the internal OSC is 8MHz.

(\*2) In the case of PDM=1, every tPON(s) is zero except for the first one.

(\*3) The order of taking each touch data, etc. cannot be changed.

### ●Dual Coordinates Conversion

The touch position for dual touch is converted to coordinates by the host processor by processing the data which the BU21029GUL outputs. The data outputted changes with the commands received from the host processor as shown in Table1. The host processor should take data from the BU21029GUL by burst read via I2C. When reception stops and resumes before all data is taken, data is again outputted from Byte0.

When using only single point detection, it may be the end of reception once each coordinate is taken.

Table 9. The Output Data List of Each Command

0	X	Y	Z1	
1	coordinate	coordinate	coordinate	X coordinate
2	X 2 points	Y 2 points	Z2	Y coordinate
3	parameter	parameter	coordinate	
4	Dummy	Ghost	Dummy	Z1 coordinate
5		parameter		
6	-	-	-	Z2 coordinate
7	-	-	-	
8	-	-	-	X 2 points
9	-	-	-	parameter
10	-	-	-	Y 2 points
11	-	-	-	parameter
12	-	-	-	Ghost
13	-	-	-	parameter
14	-	-	-	Dummy
15	-	-	-	

Table 10. The Output Data Format List

DATA	ByteH								ByteL							
	Bit07	Bit06	Bit05	Bit04	Bit03	Bit02	Bit01	Bit00	Bit07	Bit06	Bit05	Bit04	Bit03	Bit02	Bit01	Bit00
X coordinate	X[11]	X[10]	X[9]	X[8]	X[7]	X[6]	X[5]	X[4]	X[3]	X[2]	X[1]	X[0]	0	0	0	0
Y coordinate	Y[11]	Y[10]	Y[9]	Y[8]	Y[7]	Y[6]	Y[5]	Y[4]	Y[3]	Y[2]	Y[1]	Y[0]	0	0	0	0
Z1 coordinate	Z1[11]	Z1[10]	Z1[9]	Z1[8]	Z1[7]	Z1[6]	Z1[5]	Z1[4]	Z1[3]	Z1[2]	Z1[1]	Z1[0]	0	0	0	0
Z2 coordinate	Z2[11]	Z2[10]	Z2[9]	Z2[8]	Z2[7]	Z2[6]	Z2[5]	Z2[4]	Z2[3]	Z2[2]	Z2[1]	Z2[0]	0	0	0	0
X 2 points parameter	PX[9]	PX[8]	PX[7]	PX[6]	PX[5]	PX[4]	PX[3]	PX[2]	PX[1]	PX[0]	0	0	0	0	0	SPX
Y 2 points parameter	PY[9]	PY[8]	PY[7]	PY[6]	PY[5]	PY[4]	PY[3]	PY[2]	PY[1]	PY[0]	0	0	0	0	0	SPY
Ghost parameter	GH[11]	GH[10]	GH[9]	GH[8]	GH[7]	GH[6]	GH[5]	GH[4]	GH[3]	GH[2]	GH[1]	GH[0]	0	0	0	SGH

(\*1)The ByteH is the even number Byte. The ByteL is the odd number Byte. It means that X coordinates are ByteH=Byte0 and ByteL=Byte1 when it is taken with a command method.

X coordinate: Touched coordinate of X. It becomes gravity center coordinate of 2 points at dual touch.

$$X = \text{ByteH} * 16 + \text{ByteL} / 16$$

Y coordinate: Touched coordinate of Y. It becomes gravity center coordinate of 2 points at dual touch.

$$Y = \text{ByteH} * 16 + \text{ByteL} / 16$$

Z1 coordinate: Touched coordinate of Z1. It's used in calculating touch pressure.

$$Z1 = \text{ByteH} * 16 + \text{ByteL} / 16$$

Z2 coordinate: Touched coordinate of Z2. It's used in calculating touch pressure.

$$Z2 = \text{ByteH} * 16 + \text{ByteL} / 16$$

X 2-point touch parameter: It is used for 2-point touch detection. It serves as pointer of the lock up table used for x-axis 2-point distance calculation. PX may be set to 0 when SPX is 1 because the x-axis 2-point distance becomes 0.

$$\begin{aligned} \text{PX} &= \text{ByteH} * 4 + \text{ByteL} / 64 \text{ (In the case of SPX=0)} \\ \text{PX} &= (\text{ByteH} * 4 + \text{ByteL} / 64) - 1024 \text{ (In the case of SPX=1.)} \end{aligned}$$

Y 2-point touch parameter: It is used for 2-point touch detection. It serves as pointer of the lock up table used for y-axis 2-point distance calculation. PY may be set to 0 when SPY is 1 because the y-axis 2-point distance becomes 0.

$$\begin{aligned} \text{PY} &= \text{ByteH} * 4 + \text{ByteL} / 64 \text{ (In the case of SPY=0)} \\ \text{PY} &= (\text{ByteH} * 4 + \text{ByteL} / 64) - 1024 \text{ (In the case of SPY=1)} \end{aligned}$$

Ghost parameter: It is a value for judging a touch position (the direction of inclination) at dual touch.

$$\begin{aligned} \text{GH} &= \text{ByteH} * 16 + \text{ByteL} / 16 \text{ (In the case of SGH=0)} \\ \text{GH} &= (\text{ByteH} * 16 + \text{ByteL} / 16) - 4096 \text{ (In the case of SGH=1)} \end{aligned}$$



Table 11. 2-point Touch Coordinate Conversion Flow

step	operation
1	All the data is acquired and converted according to the procedure in p.16.
2	If required, a filter etc. will be processing the data.
3	If there is only 1-point touch detection, conversion ends.
4	2-point touch detection: 2-point touch is detected by comparing PX、PY and GH with a threshold. If 2-point touch is not detected, conversion ends.
5	X-axis 2-point distance calculation 1: Data is acquired from the distance conversion table using the maximum of 2 points distance (PXMAX) determined beforehand. The data is set to PRMX1.
6	X-axis 2-point distance calculation 2: Data is acquired from the distance conversion table using PX. The data is set to PRMX2.
7	X-axis 2-point distance calculation 3: The 2-point distance X-axis (DX) calculated. $DX = 2048 * (PRMX2 / PRMX1)$
8	Y-axis 2-point distance calculation 1: Data is acquired from the distance conversion table using the maximum of 2 points distance (PYMAX) determined beforehand. The data is set to PRMY1.
9	Y-axis 2-point distance calculation 2: Data is acquired from the distance conversion table using PY. The data is set to PRMY2.
10	Y-axis 2-point distance calculation 3: The 2-point distance of Y-axis (DY) calculated. $DY = 2048 * (PRMY2 / PRMY1)$
11	X-axis 2-point touch coordinate conversion: X-axis 2-point touch coordinate is converted from center position(X) and distance(DX). $X1 = X + DX$ $X2 = X - DX$
12	Y-axis 2-point touch coordinate conversion: Y-axis 2-point touch coordinate is converted from center position(Y), distance(DY) and ghost value(GH). When GH is greater than threshold. $Y1 = Y + DY$ $Y2 = Y - DY$ When GH is less than threshold. $Y1 = Y - DY$ $Y2 = Y + DY$
13	2-point coordinate is generated and since they are not exact coordinates, if 2-point coordinates are required, they process offset etc.
14	Conversion is ends.

(\*1)PXMAX is the value of PX when touching both ends of x-axis on touch screen.

(\*2)PYMAX is the value of PY when touching both ends of x-axis on touch screen.

(\*3)A coordinate is set to 4095 if it becomes over 4095 and to 0, if it becomes below 0.

### •Register Description

Table 12. CFR0 Register (PAGE=0, ADDR=0x0, Reset value=0x20)

D7	D6	D5	D4	D3	D2	D1	D0
RSV0	RSV0	CALIB	INTRM	RSV0	RSV0	RSV0	RSV0

Bits D7-D6, D3-D0: RSV0  
Reserved. Set these bits to 0.

#### Bit D5 : CALIB

Internal parameter setting-1 for calibration of dual touch detection  
0= Not to use calibration result  
1= Use calibration result

#### Bit D4 : INTRM

Setting of INT state in case BU21029GUL is active after conversion by "PDM" setting  
0= depend on "pen-down"  
1= always output "0"

Table 13. CFR1 Register (PAGE=0, ADDR=0x1, Reset value=0xA6)

D7	D6	D5	D4	D3	D2	D1	D0
MAV	AVE[2:0]			-	SMPL[2:0]		

Bit D7: MAV  
Median Average Filter  
0= Off  
1= On

#### Bits D6-D4: AVE

AVE+1= The number of average samples setting for MAV. If AVE is greater than SMPL, AVE takes the value of SMPL.

#### Bits D2-D0: SMPL

SMPL+1= The number of conversion samples setting for MAV.

Ex. In the case of CFR1 = 0xA6 (the number of average samples is 3 and the number of conversion samples is 7)

Conversion result { 1676, 1688, 1656, 1677, 1659, 1702, 4095 }

Sorted result { 1656, 1659, 1676, 1677, 1688, 1702, 4095 }

Chose 3 center data { ~~1656, 1659~~, 1676, 1677, 1688, ~~1702, 4095~~ }

Average above 3 data = (1676 + 1677 + 1688) / 3 = 1680 (vs averaged all six data = 2022)

Table 14. CFR2 Register (PAGE=0, ADDR=0x2, Reset value=0x04)

D7	D6	D5	D4	D3	D2	D1	D0
INTVL_TIME[3:0]				TIME_ST_ADC[3:0]			

Bits D7-D4: INTVL\_TIME

This sets the waiting time between completion of conversion and start of next conversion.

(Only usable setting at conversion function=0x0.)

If used, set value as four or more.

Table 15. INTVL\_TIME setting

value	time
0x0~0x3	Reserved
0x4	0.256ms
0x5	1.024ms
0x6	2.048ms
0x7	4.096ms
0x8	5.120ms
0x9	8.912ms
0xA	10.240ms
0xB	15.360ms
0xC~0xF	20.480ms

※Times shown above are calculated with oscillating frequency of internal OSC at 8MHz.

Bit D3-D0 : TIME\_ST\_ADC

This sets the waiting time between application of voltage to panel and start of A/D conversion.

Table 16. TIME\_ST\_ADC Setting

value	time
0x0	10us
0x1	20us
0x2	30us
0x3	40us
0x4	50us
0x5	60us
0x6	70us
0x7	80us
0x8	90us
0x9	100us
0xA	200us
0xB	250us
0xC	300us
0xD	350us
0xE	400us
0xF	450us

※Times shown above are calculated with oscillating frequency of internal OSC at 8MHz.

Table 17. EVR Register (PAGE=0, ADDR=0x3 to 0x5, Reset value=0x10)

D7	D6	D5	D4	D3	D2	D1	D0
EVR_*[7:0]							

Bits D7-D0: EVR\_\*

This is gain setting 1 for dual touch detection. When using 2-point detection function, it is necessary to set this before conversion. It corresponds to X, Y and XY (Z). It is not necessary to change EVR\_XY from initial value.

Table 18. PIMIR Register (PAGE=0, ADDR=0x9 to 0xA, Reset value=0x0F)

D7	D6	D5	D4	D3	D2	D1	D0
-	-	-	PIMIR_*[4:0]				

Bits D4-D0: PIMIR\_\*

This is gain setting 2 for dual touch detection. It is not necessary to change this from the initial value. It corresponds to X and Y.

Table 19. CFR3 Register (PAGE=0, ADDR=0xB, Reset value=0x72)

D7	D6	D5	D4	D3	D2	D1	D0
RM8	STRETCH	PU90K	DUAL	PIDAC_OFS[3:0]			

Bit D7: RM8

Coordinate resolution setting

0= 12bit

1= 8bit

Bit D6: STRETCH

SCL\_STRETCH function setting

0= off

1= on

Bit D5 : PU90K

Internal pull-up resistance for touch detection setting

0= about 50kΩ

1= about 90kΩ

Bit D4: DUAL

Dual touch detection function setting

0= Off

1= On

Bits D3-D0: PIDAC\_OFS

Dual touch detection circuit adjustment setting. It is not necessary to change this from initial value.

Table 20. LDO Register (PAGE=0, ADDR=0xC, Reset value=0x00)

D7	D6	D5	D4	D3	D2	D1	D0
-	PVDD[2:0]			-	AVDD[2:0]		

Bits D6-D4: PVDD

Regulator for panel output setting.

By increasing voltage, influence of exogenous noise from the panel interface is reduced.

Table 21. PVDD setting

value	output
0	1.500V
1	1.556V
2	1.615V
3	1.680V
4	1.750V
5	1.826V
6	1.909V
7	2.000V

Bits D2-D0: AVDD

The output voltage setting of the analog circuit regulator

The relationship of setting value and output voltage is same as PVDD.

It is not possible to change from the initial value when VDD or PVDD is lower than 2.5V.

Table 22. STATUS Register (PAGE=0, ADDR=0xD, Reset value=0x00, Read only)

D7	D6	D5	D4	D3	D2	D1	D0
TEST	AUTO	PDM	-	BUSY	ACTIVE	CALIB _DONE	TOUCH

Bit D7: TEST

This bit will become "1" during TEST mode.

Bit D6: AUTO

This bit will become "1" at conversion function 0.

Bit D5: PDM

PDM setting value of command byte1

Bit D3: BUSY

This bit will become "1" during conversion of 1<sup>st</sup> coordinate data.

Bit D2: ACTIVE

This bit will become "1" when internal analog circuit is active.

Bit D1: CALIB\_DONE

This bit will become "1" in case that dual touch detection parameter adjustment is finished by command (CF=0x5).

This bit will be clear when "1" is written on this bit.

Bit D0: TOUCH

This bit will become "1" when pen-down is internally detected.

Table 23. HW\_ID1 Register (PAGE=0, ADDR=0xE, Reset value=0x02, Read only)

D7	D6	D5	D4	D3	D2	D1	D0
HW_IDH							

Bits D7-D0: HW\_IDH

High 8bit of IC's ID

Table 24. HW\_ID2 Register (PAGE=0, ADDR=0xF, Reset value=0x29, Read only)

D7	D6	D5	D4	D3	D2	D1	D0
HW_IDL							

Bits D7-D0: HW\_IDL

Low 8-bit of IC's ID

Table 25. FREE\_SW1 Register (PAGE=1, ADDR=0x0, Reset value=0x00)

D7	D6	D5	D4	D3	D2	D1	D0
SW_YP_ POW	SW_YP_ GND	SW_YN_ POW	SW_YN_ GND	SW_XP_ POW	SW_XP_ GND	SW_XN_ POW	SW_XN_ GND

Bits D7-D0: SW\_\*\*\_POW(GND)

Driver setting at conversion function 4(Free scan)

Drive to "+" by set POW and "-" by set GND, Must not set "+" and "-" to one terminal at the same time.

\*\* = the corresponding terminal name

Table 26. FREE\_SW2 Register (PAGE=1, ADDR=0x1, Reset value=0x00)

D7	D6	D5	D4	D3	D2	D1	D0
RSV0	RSV0	RSV0	SW_AUX	SW_YPM	SW_YNM	SW_XPM	SW_XNM

Bits D7 – D5: RSV0

Reserved. They must be set "0".

Bit D4: SW\_AUX

Bit D3-D0: SW\_\*\*M

A/D input setting at conversion function 4(Free scan)

\*\* = the corresponding terminal name

Table 27. SPCFG (PAGE=1, ADDR=0x5, Reset value=0x03)

D7	D6	D5	D4	D3	D2	D1	D0
RSV0	DPRM	RSV0	RSV0	RSV0	RSV0	RSV1	RSV1

Bits D7, D5-D2 : RSV0 , Bits D1-D0 : RSV1

RSV0 must be set to 0 and RSV1 must be set to 0

Bit D6: DPRM

2-point touch parameter through mode 0=Off (Normal) 1=On (Through for test).

## ●Operational Notes

**1. Reverse Connection of Power Supply**

Connecting the power supply in reverse polarity can damage the IC. Take precautions against reverse polarity when connecting the power supply, such as mounting an external diode between the power supply and the IC's power supply terminals.

**2. Power Supply Lines**

Design the PCB layout pattern to provide low impedance supply lines. Separate the ground and supply lines of the digital and analog blocks to prevent noise in the ground and supply lines of the digital block from affecting the analog block. Furthermore, connect a capacitor to ground at all power supply pins. Consider the effect of temperature and aging on the capacitance value when using electrolytic capacitors.

**3. Ground Voltage**

Ensure that no pins are at a voltage below that of the ground pin at any time, even during transient condition.

**4. Ground Wiring Pattern**

When using both small-signal and large-current ground traces, the two ground traces should be routed separately but connected to a single ground at the reference point of the application board to avoid fluctuations in the small-signal ground caused by large currents. Also ensure that the ground traces of external components do not cause variations on the ground voltage. The ground lines must be as short and thick as possible to reduce line impedance.

**5. Thermal Consideration**

Should by any chance the power dissipation rating be exceeded, the rise in temperature of the chip may result in deterioration of the properties of the chip. The absolute maximum rating of the Pd stated in this specification is when the IC is mounted on a 70mm x 70mm x 1.6mm glass epoxy board. In case of exceeding this absolute maximum rating, increase the board size and copper area to prevent exceeding the Pd rating.

**6. Recommended Operating Conditions**

These conditions represent a range within which the expected characteristics of the IC can be approximately obtained. The electrical characteristics are guaranteed under the conditions of each parameter.

**7. Rush Current**

When power is first supplied to the IC, it is possible that the internal logic may be unstable and inrush current may flow instantaneously due to the internal powering sequence and delays, especially if the IC has more than one power supply. Therefore, give special consideration to power coupling capacitance, power wiring, width of ground wiring, and routing of connections.

**8. Operation Under Strong Electromagnetic Field**

Operating the IC in the presence of a strong electromagnetic field may cause the IC to malfunction.

**9. Testing on Application Boards**

When testing the IC on an application board, connecting a capacitor directly to a low-impedance output pin may subject the IC to stress. Always discharge capacitors completely after each process or step. The IC's power supply should always be turned off completely before connecting or removing it from the test setup during the inspection process. To prevent damage from static discharge, ground the IC during assembly and use similar precautions during transport and storage.

**10. Inter-pin Short and Mounting Errors**

Ensure that the direction and position are correct when mounting the IC on the PCB. Incorrect mounting may result in damaging the IC. Avoid nearby pins being shorted to each other especially to ground, power supply and output pin. Inter-pin shorts could be due to many reasons such as metal particles, water droplets (in very humid environment) and unintentional solder bridge deposited in between pins during assembly to name a few.

**11. Unused Input Terminals**

Input terminals of an IC are often connected to the gate of a MOS transistor. The gate has extremely high impedance and extremely low capacitance. If left unconnected, the electric field from the outside can easily charge it. The small charge acquired in this way is enough to produce a significant effect on the conduction through the transistor and cause unexpected operation of the IC. So unless otherwise specified, unused input terminals should be connected to the power supply or ground line.

**12. Regarding Input Pins of the IC**

In the construction of this IC, P-N junctions are inevitably formed creating parasitic diodes or transistors. The operation of these parasitic elements can result in mutual interference among circuits, operational faults, or physical damage. Therefore, conditions which cause these parasitic elements to operate, such as applying a voltage to an input pin lower than the ground voltage should be avoided. Furthermore, do not apply a voltage to the input terminals when no power supply voltage is applied to the IC. Even if the power supply voltage is applied, make sure that the input terminals have voltages within the values specified in the electrical characteristics of this IC.

**13. Ceramic Capacitor**

When using a ceramic capacitor, determine the dielectric constant considering the change of capacitance with temperature and the decrease in nominal capacitance due to DC bias and others.

**14. Others**

If this LSI will be used, please read other detailed documents such as Functional Description and Application Note.



●Ordering Information

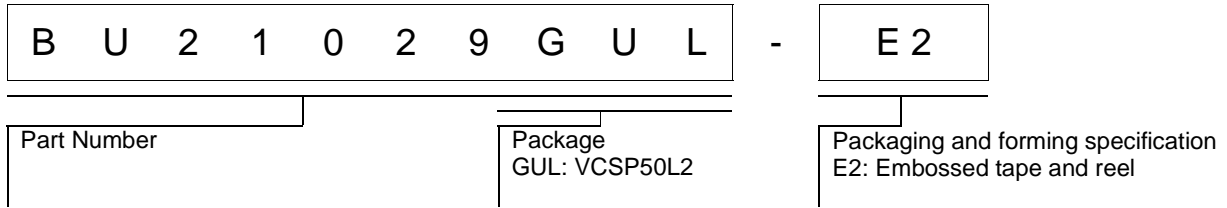

●Physical Dimension Tape and Reel Information

VCSP50L2

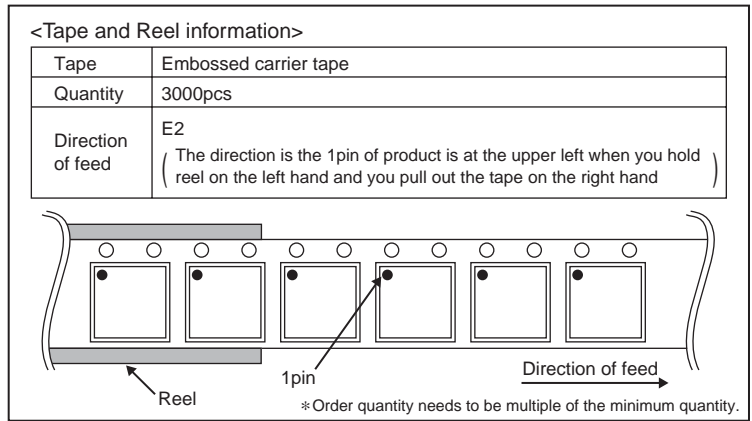
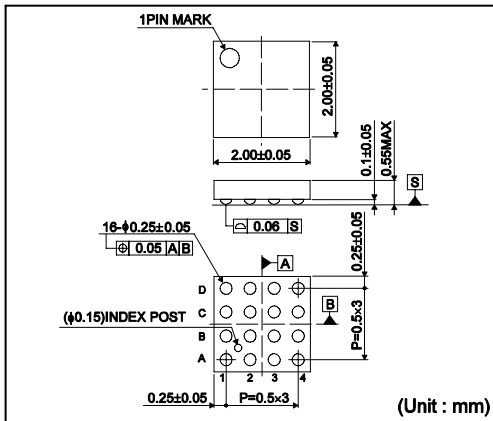

●Marking Diagram

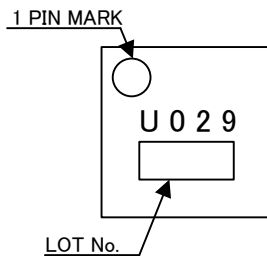

## ●改訂履歴

Date	Revision	Changes
11.Nov.2013	002	New Release

# Notice

## Precaution on using ROHM Products

- Our Products are designed and manufactured for application in ordinary electronic equipments (such as AV equipment, OA equipment, telecommunication equipment, home electronic appliances, amusement equipment, etc.). If you intend to use our Products in devices requiring extremely high reliability (such as medical equipment <sup>(Note 1)</sup>, transport equipment, traffic equipment, aircraft/spacecraft, nuclear power controllers, fuel controllers, car equipment including car accessories, safety devices, etc.) and whose malfunction or failure may cause loss of human life, bodily injury or serious damage to property ("Specific Applications"), please consult with the ROHM sales representative in advance. Unless otherwise agreed in writing by ROHM in advance, ROHM shall not be in any way responsible or liable for any damages, expenses or losses incurred by you or third parties arising from the use of any ROHM's Products for Specific Applications.

(Note1) Medical Equipment Classification of the Specific Applications

JAPAN	USA	EU	CHINA
CLASS III	CLASS III	CLASS II b	CLASS III
CLASS IV		CLASS III	

- ROHM designs and manufactures its Products subject to strict quality control system. However, semiconductor products can fail or malfunction at a certain rate. Please be sure to implement, at your own responsibilities, adequate safety measures including but not limited to fail-safe design against the physical injury, damage to any property, which a failure or malfunction of our Products may cause. The following are examples of safety measures:
  - Installation of protection circuits or other protective devices to improve system safety
  - Installation of redundant circuits to reduce the impact of single or multiple circuit failure
- Our Products are designed and manufactured for use under standard conditions and not under any special or extraordinary environments or conditions, as exemplified below. Accordingly, ROHM shall not be in any way responsible or liable for any damages, expenses or losses arising from the use of any ROHM's Products under any special or extraordinary environments or conditions. If you intend to use our Products under any special or extraordinary environments or conditions (as exemplified below), your independent verification and confirmation of product performance, reliability, etc. prior to use, must be necessary:
  - Use of our Products in any types of liquid, including water, oils, chemicals, and organic solvents
  - Use of our Products outdoors or in places where the Products are exposed to direct sunlight or dust
  - Use of our Products in places where the Products are exposed to sea wind or corrosive gases, including Cl<sub>2</sub>, H<sub>2</sub>S, NH<sub>3</sub>, SO<sub>2</sub>, and NO<sub>2</sub>
  - Use of our Products in places where the Products are exposed to static electricity or electromagnetic waves
  - Use of our Products in proximity to heat-producing components, plastic cords, or other flammable items
  - Sealing or coating our Products with resin or other coating materials
  - Use of our Products without cleaning residue of flux (even if you use no-clean type fluxes, cleaning residue of flux is recommended); or Washing our Products by using water or water-soluble cleaning agents for cleaning residue after soldering
  - Use of the Products in places subject to dew condensation
- The Products are not subject to radiation-proof design.
- Please verify and confirm characteristics of the final or mounted products in using the Products.
- In particular, if a transient load (a large amount of load applied in a short period of time, such as pulse. is applied, confirmation of performance characteristics after on-board mounting is strongly recommended. Avoid applying power exceeding normal rated power; exceeding the power rating under steady-state loading condition may negatively affect product performance and reliability.
- De-rate Power Dissipation (Pd) depending on Ambient temperature (Ta). When used in sealed area, confirm the actual ambient temperature.
- Confirm that operation temperature is within the specified range described in the product specification.
- ROHM shall not be in any way responsible or liable for failure induced under deviant condition from what is defined in this document.

## Precaution for Mounting / Circuit board design

- When a highly active halogenous (chlorine, bromine, etc.) flux is used, the residue of flux may negatively affect product performance and reliability.
- In principle, the reflow soldering method must be used; if flow soldering method is preferred, please consult with the ROHM representative in advance.

For details, please refer to ROHM Mounting specification

**Precautions Regarding Application Examples and External Circuits**

1. If change is made to the constant of an external circuit, please allow a sufficient margin considering variations of the characteristics of the Products and external components, including transient characteristics, as well as static characteristics.
2. You agree that application notes, reference designs, and associated data and information contained in this document are presented only as guidance for Products use. Therefore, in case you use such information, you are solely responsible for it and you must exercise your own independent verification and judgment in the use of such information contained in this document. ROHM shall not be in any way responsible or liable for any damages, expenses or losses incurred by you or third parties arising from the use of such information.

**Precaution for Electrostatic**

This Product is electrostatic sensitive product, which may be damaged due to electrostatic discharge. Please take proper caution in your manufacturing process and storage so that voltage exceeding the Products maximum rating will not be applied to Products. Please take special care under dry condition (e.g. Grounding of human body / equipment / solder iron, isolation from charged objects, setting of Ionizer, friction prevention and temperature / humidity control).

**Precaution for Storage / Transportation**

1. Product performance and soldered connections may deteriorate if the Products are stored in the places where:
  - [a] the Products are exposed to sea winds or corrosive gases, including Cl<sub>2</sub>, H<sub>2</sub>S, NH<sub>3</sub>, SO<sub>2</sub>, and NO<sub>2</sub>
  - [b] the temperature or humidity exceeds those recommended by ROHM
  - [c] the Products are exposed to direct sunshine or condensation
  - [d] the Products are exposed to high Electrostatic
2. Even under ROHM recommended storage condition, solderability of products out of recommended storage time period may be degraded. It is strongly recommended to confirm solderability before using Products of which storage time is exceeding the recommended storage time period.
3. Store / transport cartons in the correct direction, which is indicated on a carton with a symbol. Otherwise bent leads may occur due to excessive stress applied when dropping of a carton.
4. Use Products within the specified time after opening a humidity barrier bag. Baking is required before using Products of which storage time is exceeding the recommended storage time period.

**Precaution for Product Label**

QR code printed on ROHM Products label is for ROHM's internal use only.

**Precaution for Disposition**

When disposing Products please dispose them properly using an authorized industry waste company.

**Precaution for Foreign Exchange and Foreign Trade act**

Since our Products might fall under controlled goods prescribed by the applicable foreign exchange and foreign trade act, please consult with ROHM representative in case of export.

**Precaution Regarding Intellectual Property Rights**

1. All information and data including but not limited to application example contained in this document is for reference only. ROHM does not warrant that foregoing information or data will not infringe any intellectual property rights or any other rights of any third party regarding such information or data. ROHM shall not be in any way responsible or liable for infringement of any intellectual property rights or other damages arising from use of such information or data.:
2. No license, expressly or implied, is granted hereby under any intellectual property rights or other rights of ROHM or any third parties with respect to the information contained in this document.

**Other Precaution**

1. This document may not be reprinted or reproduced, in whole or in part, without prior written consent of ROHM.
2. The Products may not be disassembled, converted, modified, reproduced or otherwise changed without prior written consent of ROHM.
3. In no event shall you use in any way whatsoever the Products and the related technical information contained in the Products or this document for any military purposes, including but not limited to, the development of mass-destruction weapons.
4. The proper names of companies or products described in this document are trademarks or registered trademarks of ROHM, its affiliated companies or third parties.

**General Precaution**

1. Before you use our Products, you are requested to carefully read this document and fully understand its contents. ROHM shall not be in any way responsible or liable for failure, malfunction or accident arising from the use of any ROHM's Products against warning, caution or note contained in this document.
2. All information contained in this document is current as of the issuing date and subject to change without any prior notice. Before purchasing or using ROHM's Products, please confirm the latest information with a ROHM sales representative.
3. The information contained in this document is provided on an "as is" basis and ROHM does not warrant that all information contained in this document is accurate and/or error-free. ROHM shall not be in any way responsible or liable for any damages, expenses or losses incurred by you or third parties resulting from inaccuracy or errors of or concerning such information.



## Стандарт Электрон Связь

Мы молодая и активно развивающаяся компания в области поставок электронных компонентов. Мы поставляем электронные компоненты отечественного и импортного производства напрямую от производителей и с крупнейших складов мира.

Благодаря сотрудничеству с мировыми поставщиками мы осуществляем комплексные и плановые поставки широчайшего спектра электронных компонентов.

Собственная эффективная логистика и склад в обеспечивает надежную поставку продукции в точно указанные сроки по всей России.

Мы осуществляем техническую поддержку нашим клиентам и предпродажную проверку качества продукции. На все поставляемые продукты мы предоставляем гарантию .

Осуществляем поставки продукции под контролем ВП МО РФ на предприятия военно-промышленного комплекса России , а также работаем в рамках 275 ФЗ с открытием отдельных счетов в уполномоченном банке. Система менеджмента качества компании соответствует требованиям ГОСТ ISO 9001.

Минимальные сроки поставки, гибкие цены, неограниченный ассортимент и индивидуальный подход к клиентам являются основой для выстраивания долгосрочного и эффективного сотрудничества с предприятиями радиоэлектронной промышленности, предприятиями ВПК и научно-исследовательскими институтами России.

С нами вы становитесь еще успешнее!

### Наши контакты:

**Телефон:** +7 812 627 14 35

**Электронная почта:** [sales@st-electron.ru](mailto:sales@st-electron.ru)

**Адрес:** 198099, Санкт-Петербург,  
Промышленная ул, дом № 19, литера Н,  
помещение 100-Н Офис 331