

Low Loss IGBT in TrenchStop® and Fieldstop technology

- Short circuit withstand time – 10µs
- Designed for :
 - Frequency Converters
 - Uninterrupted Power Supply
- TrenchStop® and Fieldstop technology for 1200 V applications offers :
 - very tight parameter distribution
 - high ruggedness, temperature stable behavior
- NPT technology offers easy parallel switching capability due to positive temperature coefficient in $V_{CE(sat)}$
- Low EMI
- Low Gate Charge
- Qualified according to JEDEC¹ for target applications
- Pb-free lead plating; RoHS compliant
- Complete product spectrum and PSpice Models : <http://www.infineon.com/igbt/>

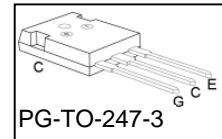
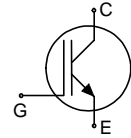

Type	V_{CE}	I_C	$V_{CE(sat), T_j=25^\circ C}$	$T_{j,max}$	Marking Code	Package
IGW40T120	1200V	40A	1.7V	150°C	G40T120	PG-TO-247-3

Maximum Ratings

Parameter	Symbol	Value	Unit
Collector-emitter voltage	V_{CE}	1200	V
DC collector current	I_C		A
$T_C = 25^\circ C$		75	
$T_C = 100^\circ C$		40	
Pulsed collector current, t_p limited by $T_{j,max}$	$I_{C,puls}$	105	
Turn off safe operating area	-	105	
$V_{CE} \leq 1200V, T_j \leq 150^\circ C$			
Gate-emitter voltage	V_{GE}	± 20	V
Short circuit withstand time ²⁾	t_{SC}	10	µs
$V_{GE} = 15V, V_{CC} \leq 1200V, T_j \leq 150^\circ C$			
Power dissipation	P_{tot}	270	W
$T_C = 25^\circ C$			
Operating junction temperature	T_j	-40...+150	°C
Storage temperature	T_{stg}	-55...+150	
Soldering temperature, 1.6mm (0.063 in.) from case for 10s	-	260	

¹ J-STD-020 and JESD-022

²⁾ Allowed number of short circuits: <1000; time between short circuits: >1s.

Thermal Resistance

Parameter	Symbol	Conditions	Max. Value	Unit
Characteristic				
IGBT thermal resistance, junction – case	R_{thJC}		0.45	K/W
Thermal resistance, junction – ambient	R_{thJA}		40	

Electrical Characteristic, at $T_j = 25\text{ °C}$, unless otherwise specified

Parameter	Symbol	Conditions	Value			Unit
			min.	typ.	max.	
Static Characteristic						
Collector-emitter breakdown voltage	$V_{(BR)CES}$	$V_{GE}=0V, I_C=1.5mA$	1200	-	-	V
Collector-emitter saturation voltage	$V_{CE(sat)}$	$V_{GE} = 15V, I_C=40A$ $T_j=25\text{ °C}$ $T_j=125\text{ °C}$ $T_j=150\text{ °C}$	-	1.7	2.3	
			-	2.1	-	
			-	2.3	-	
Gate-emitter threshold voltage	$V_{GE(th)}$	$I_C=1.5mA, V_{CE}=V_{GE}$	5.0	5.8	6.5	
Zero gate voltage collector current	I_{CES}	$V_{CE}=1200V,$ $V_{GE}=0V$ $T_j=25\text{ °C}$ $T_j=150\text{ °C}$	-	-	0.4	mA
			-	-	4.0	
Gate-emitter leakage current	I_{GES}	$V_{CE}=0V, V_{GE}=20V$	-	-	600	nA
Transconductance	g_{fs}	$V_{CE}=20V, I_C=40A$	-	21	-	S
Integrated gate resistor	R_{Gint}			6		Ω

Dynamic Characteristic

Input capacitance	C_{iss}	$V_{CE}=25V,$ $V_{GE}=0V,$ $f=1MHz$	-	2500	-	pF
Output capacitance	C_{oss}		-	130	-	
Reverse transfer capacitance	C_{rss}		-	110	-	
Gate charge	Q_{Gate}	$V_{CC}=960V, I_C=40A$ $V_{GE}=15V$	-	203	-	nC
Internal emitter inductance measured 5mm (0.197 in.) from case	L_E		-	13	-	nH
Short circuit collector current ¹⁾	$I_{C(SC)}$	$V_{GE}=15V, t_{SC} \leq 10\mu s$ $V_{CC} = 600V,$ $T_j = 25^\circ C$	-	210	-	A

Switching Characteristic, Inductive Load, at $T_j=25^\circ C$

Parameter	Symbol	Conditions	Value			Unit
			min.	typ.	max.	

IGBT Characteristic

Turn-on delay time	$t_{d(on)}$	$T_j=25^\circ C,$ $V_{CC}=600V, I_C=40A,$ $V_{GE}=0/15V,$ $R_G=15\Omega,$ $L_\sigma^{2)}=180nH,$ $C_\sigma^{2)}=39pF$ Energy losses include "tail" and diode reverse recovery.	-	48	-	ns
Rise time	t_r		-	34	-	
Turn-off delay time	$t_{d(off)}$		-	480	-	
Fall time	t_f		-	70	-	mJ
Turn-on energy	E_{on}		-	3.3	-	
Turn-off energy	E_{off}		-	3.2	-	
Total switching energy	E_{ts}		-	6.5	-	

Switching Characteristic, Inductive Load, at $T_j=150^\circ C$

Parameter	Symbol	Conditions	Value			Unit
			min.	typ.	max.	

IGBT Characteristic

Turn-on delay time	$t_{d(on)}$	$T_j=150^\circ C$ $V_{CC}=600V, I_C=40A,$ $V_{GE}=0/15V,$ $R_G=15\Omega,$ $L_\sigma^{2)}=180nH,$ $C_\sigma^{2)}=39pF$ Energy losses include "tail" and diode reverse recovery.	-	52	-	ns
Rise time	t_r		-	40	-	
Turn-off delay time	$t_{d(off)}$		-	580	-	
Fall time	t_f		-	120	-	mJ
Turn-on energy	E_{on}		-	5.0	-	
Turn-off energy	E_{off}		-	5.4	-	
Total switching energy	E_{ts}		-	10.4	-	

¹⁾ Allowed number of short circuits: <1000; time between short circuits: >1s.

²⁾ Leakage inductance L_σ and Stray capacity C_σ due to dynamic test circuit in Figure E.

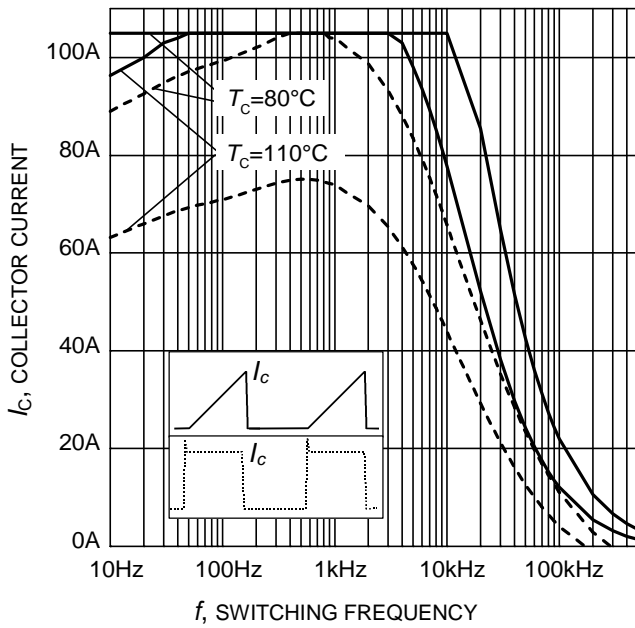

Figure 1. Collector current as a function of switching frequency
 ($T_j \leq 150^\circ\text{C}$, $D = 0.5$, $V_{CE} = 600\text{V}$,
 $V_{GE} = 0/+15\text{V}$, $R_G = 15\Omega$)

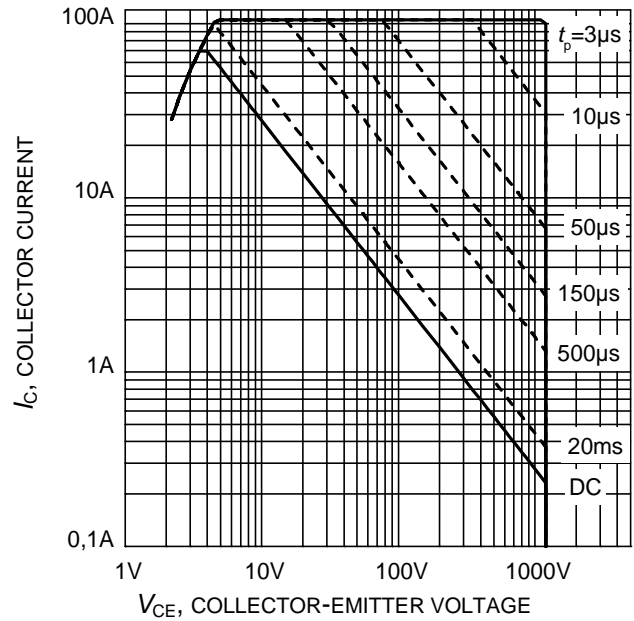

Figure 2. Safe operating area
 ($D = 0$, $T_C = 25^\circ\text{C}$,
 $T_j \leq 150^\circ\text{C}$; $V_{GE} = 15\text{V}$)

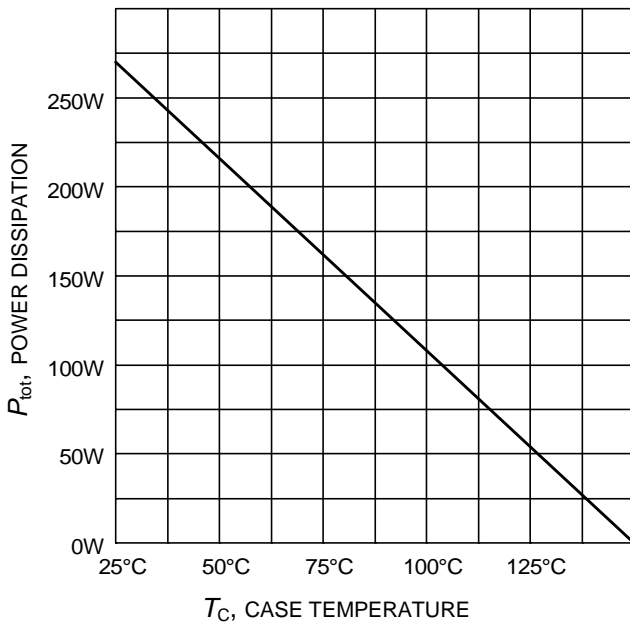

Figure 3. Power dissipation as a function of case temperature
 ($T_j \leq 150^\circ\text{C}$)

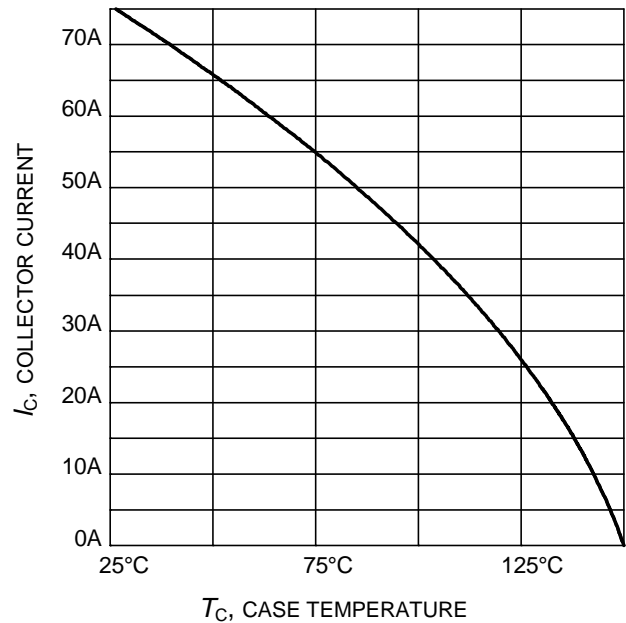

Figure 4. Collector current as a function of case temperature
 ($V_{GE} \geq 15\text{V}$, $T_j \leq 150^\circ\text{C}$)

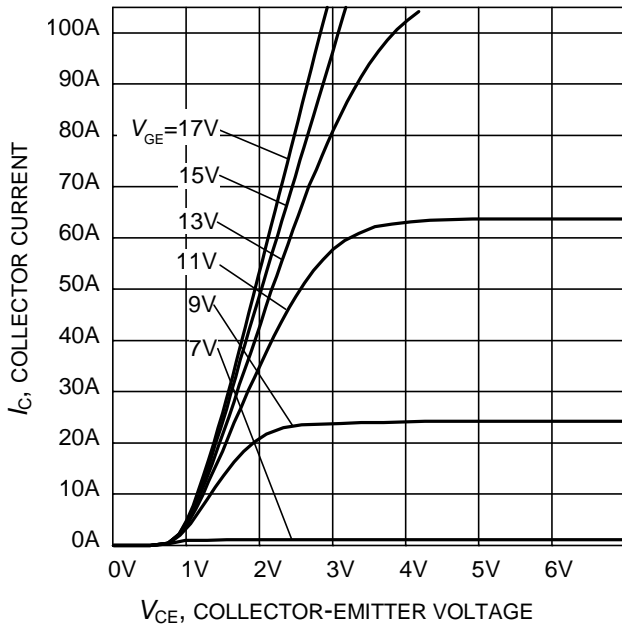

Figure 5. Typical output characteristic
($T_j = 25^\circ\text{C}$)

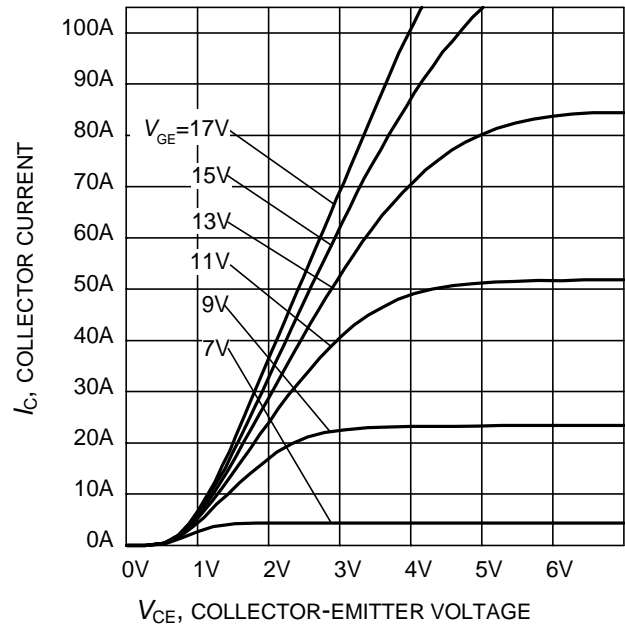

Figure 6. Typical output characteristic
($T_j = 150^\circ\text{C}$)

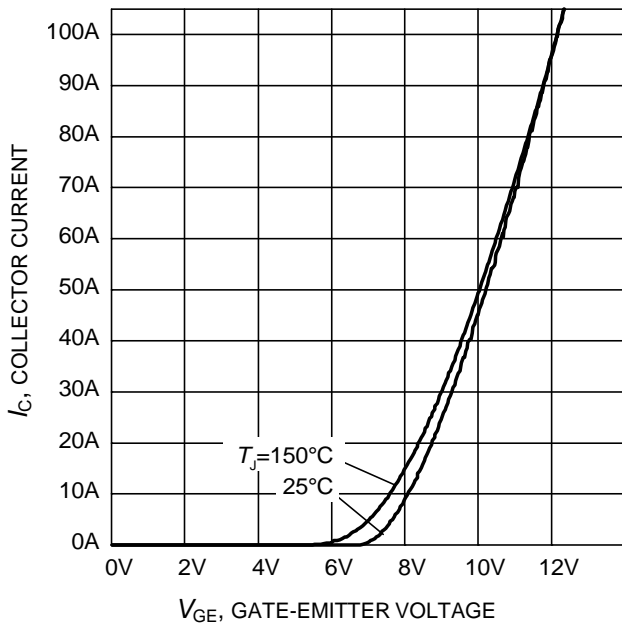

Figure 7. Typical transfer characteristic
($V_{CE} = 20\text{V}$)

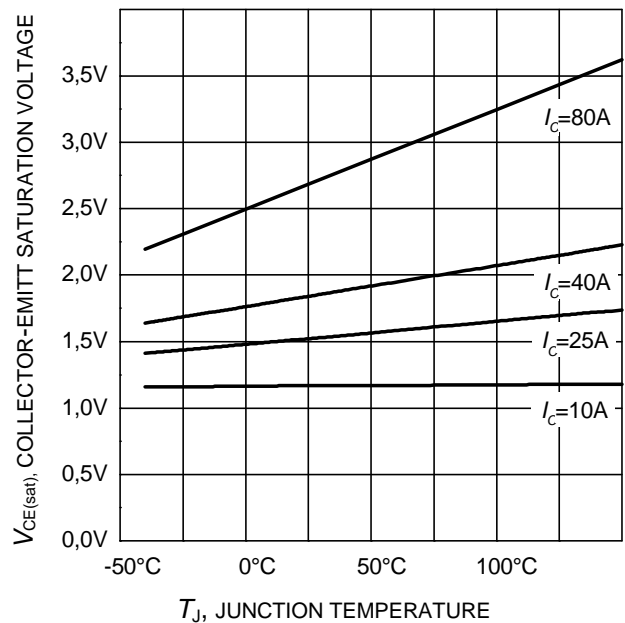

Figure 8. Typical collector-emitter saturation voltage as a function of junction temperature
($V_{GE} = 15\text{V}$)

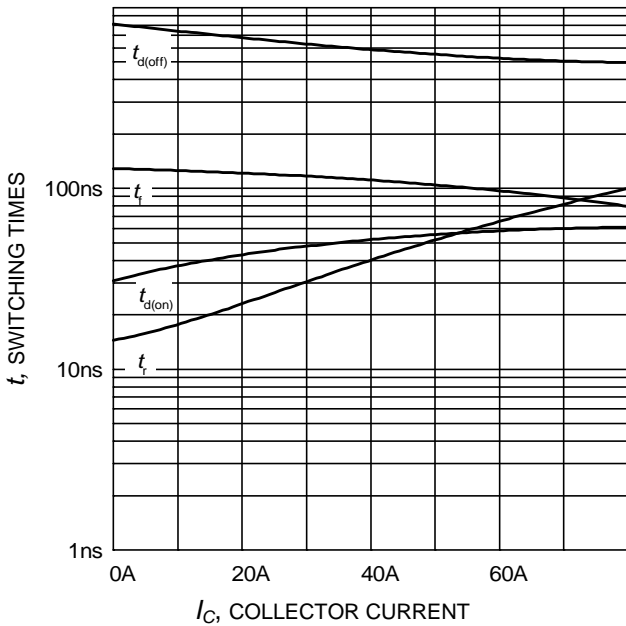

Figure 9. Typical switching times as a function of collector current
(inductive load, $T_J=150^{\circ}\text{C}$, $V_{CE}=600\text{V}$, $V_{GE}=0/15\text{V}$, $R_G=15\Omega$, Dynamic test circuit in Figure E)

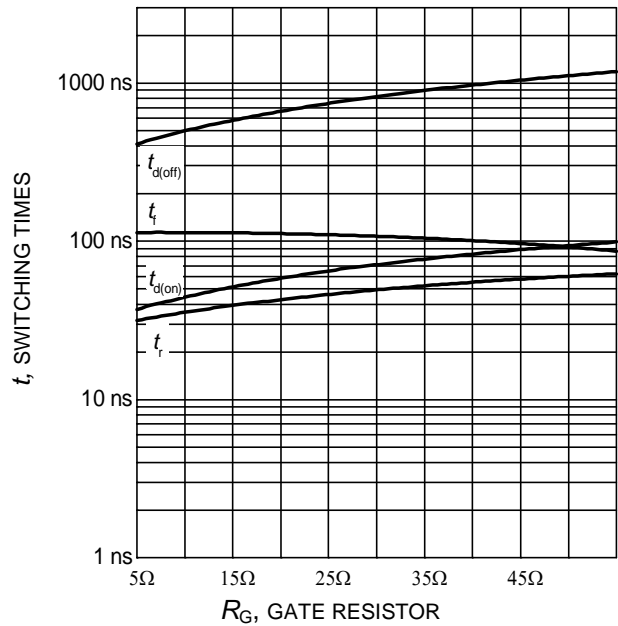

Figure 10. Typical switching times as a function of gate resistor
(inductive load, $T_J=150^{\circ}\text{C}$, $V_{CE}=600\text{V}$, $V_{GE}=0/15\text{V}$, $I_C=40\text{A}$, Dynamic test circuit in Figure E)

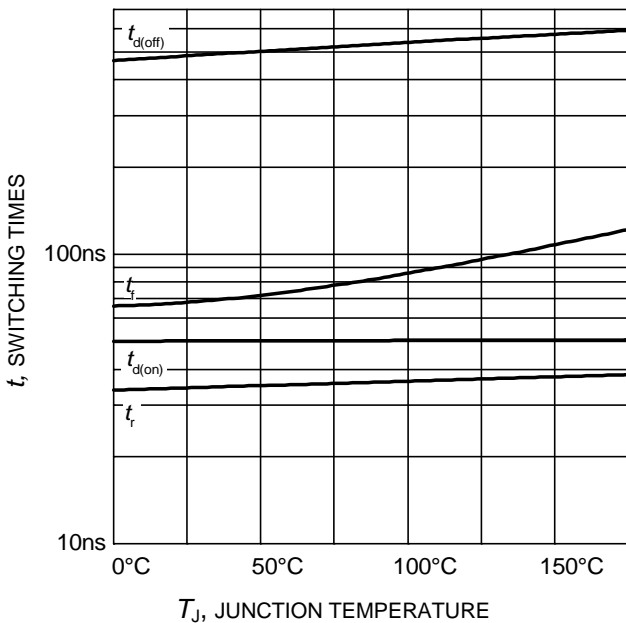

Figure 11. Typical switching times as a function of junction temperature
(inductive load, $V_{CE}=600\text{V}$, $V_{GE}=0/15\text{V}$, $I_C=40\text{A}$, $R_G=15\Omega$, Dynamic test circuit in Figure E)

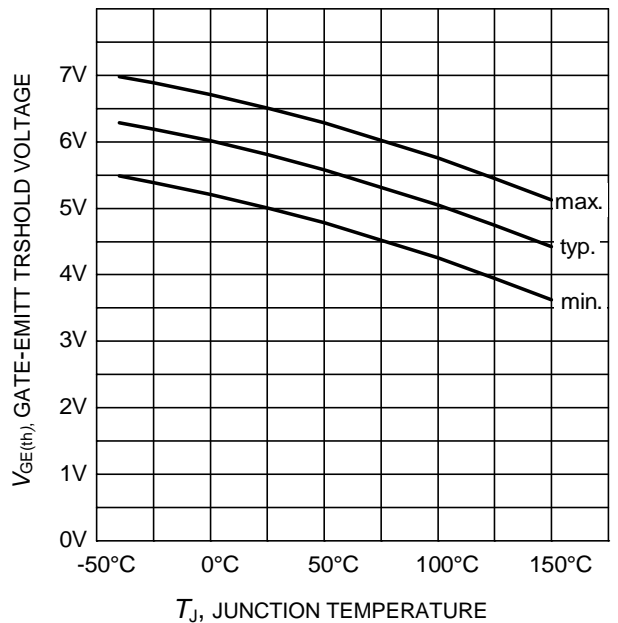

Figure 12. Gate-emitter threshold voltage as a function of junction temperature
($I_C = 1.5\text{mA}$)

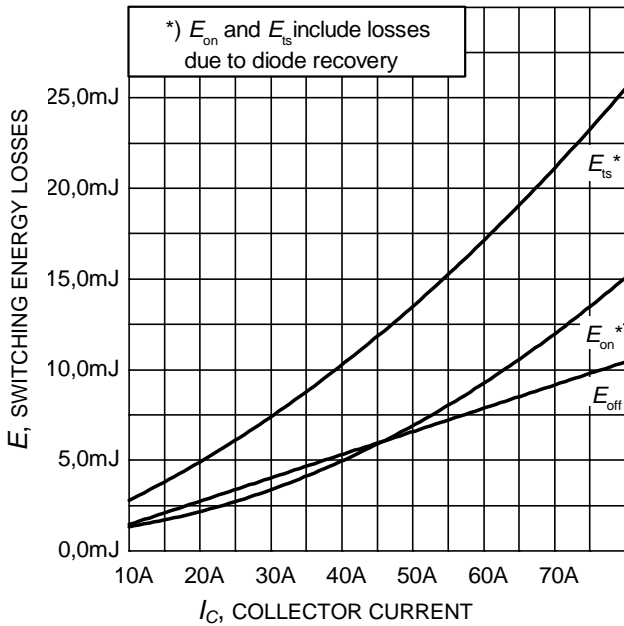

Figure 13. Typical switching energy losses as a function of collector current
(inductive load, $T_J=150^\circ\text{C}$, $V_{CE}=600\text{V}$, $V_{GE}=0/15\text{V}$, $R_G=15\Omega$, Dynamic test circuit in Figure E)

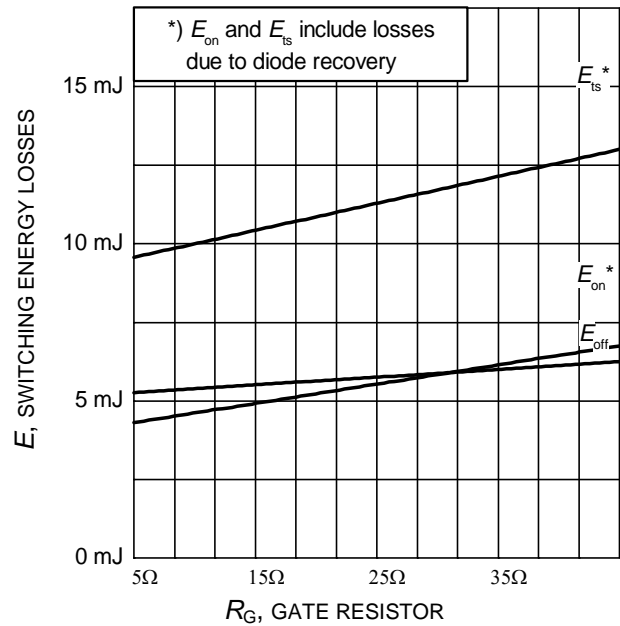

Figure 14. Typical switching energy losses as a function of gate resistor
(inductive load, $T_J=150^\circ\text{C}$, $V_{CE}=600\text{V}$, $V_{GE}=0/15\text{V}$, $I_C=40\text{A}$, Dynamic test circuit in Figure E)

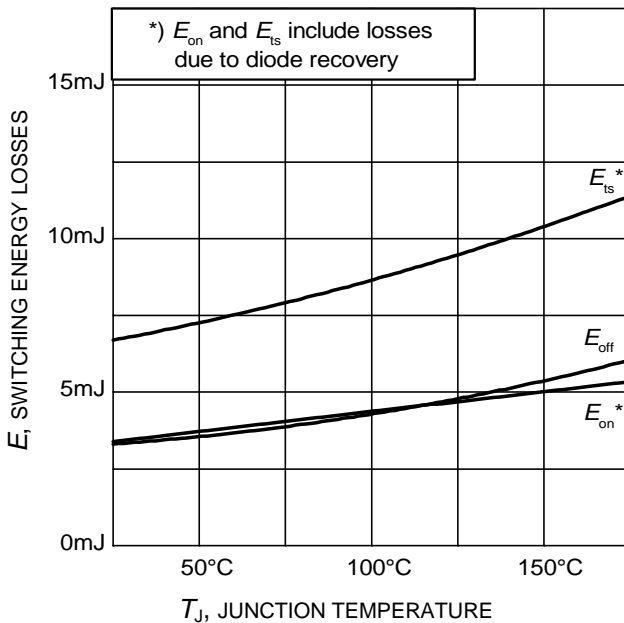

Figure 15. Typical switching energy losses as a function of junction temperature
(inductive load, $V_{CE}=600\text{V}$, $V_{GE}=0/15\text{V}$, $I_C=40\text{A}$, $R_G=15\Omega$, Dynamic test circuit in Figure E)

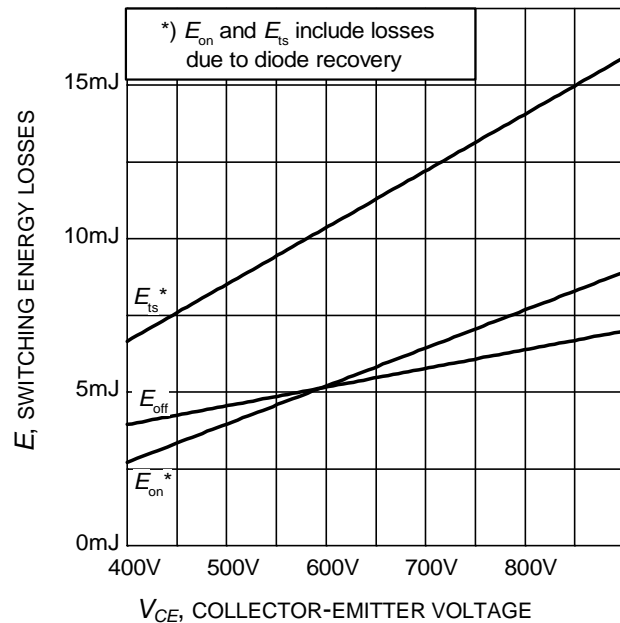

Figure 16. Typical switching energy losses as a function of collector emitter voltage
(inductive load, $T_J=150^\circ\text{C}$, $V_{GE}=0/15\text{V}$, $I_C=40\text{A}$, $R_G=15\Omega$, Dynamic test circuit in Figure E)

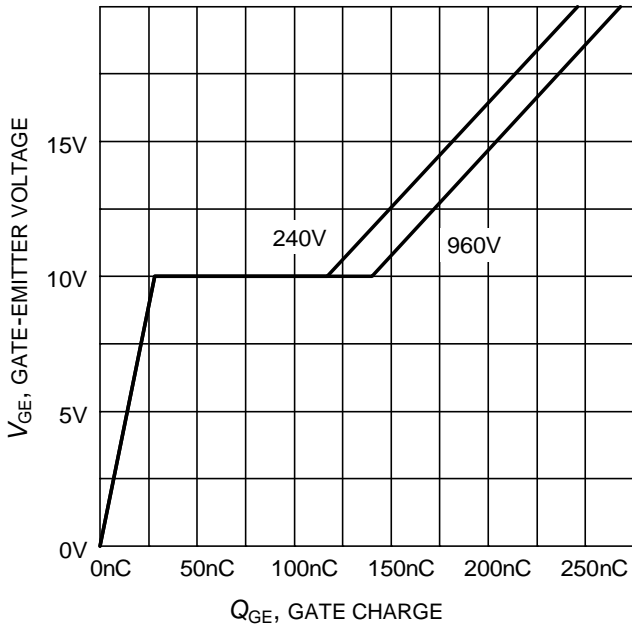

Figure 17. Typical gate charge
($I_C=40\text{ A}$)

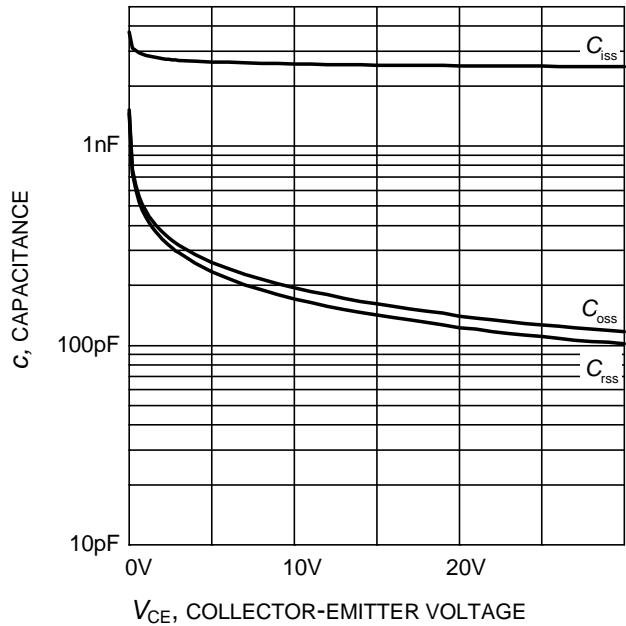

Figure 18. Typical capacitance as a function of collector-emitter voltage
($V_{GE}=0\text{V}$, $f = 1\text{ MHz}$)

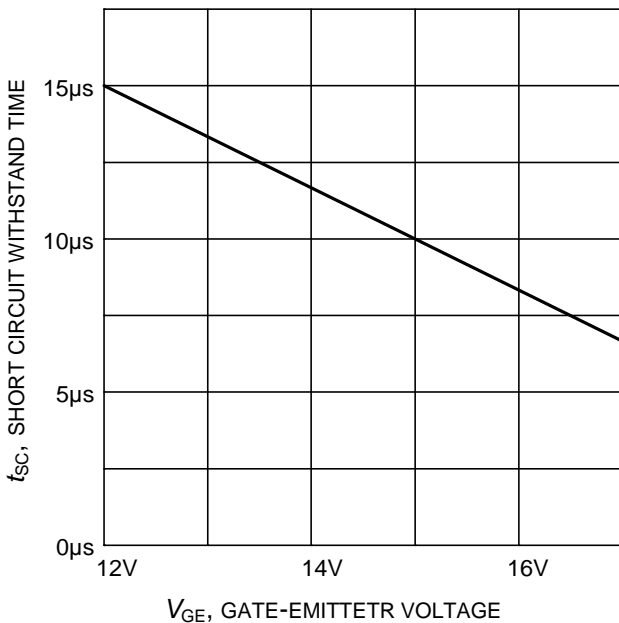

Figure 19. Short circuit withstand time as a function of gate-emitter voltage
($V_{CE}=600\text{V}$, start at $T_j=25^\circ\text{C}$)

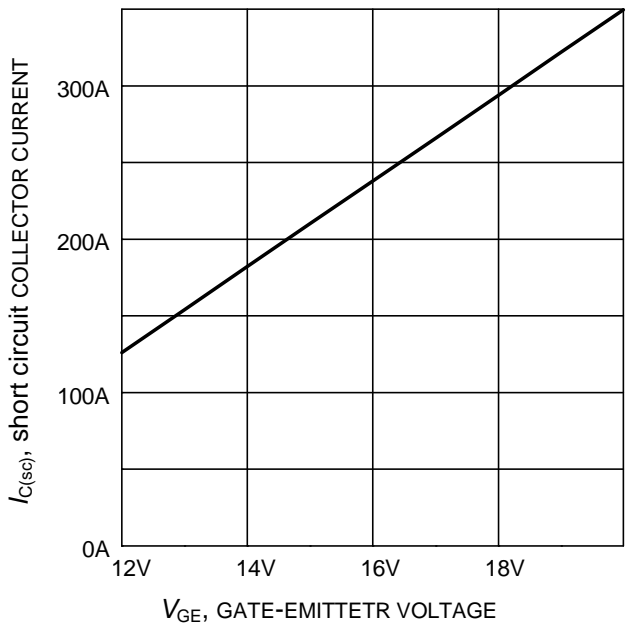

Figure 20. Typical short circuit collector current as a function of gate-emitter voltage
($V_{CE} \leq 600\text{V}$, $T_j \leq 150^\circ\text{C}$)

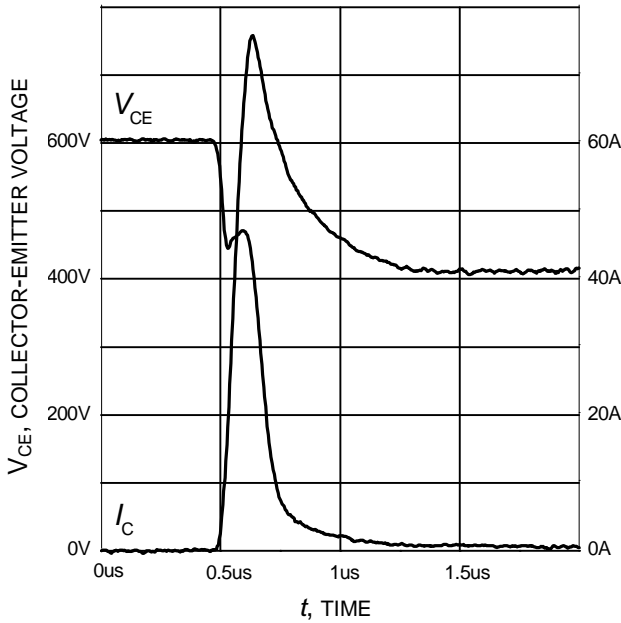

Figure 21. Typical turn on behavior
 ($V_{GE}=0/15V$, $R_G=15\Omega$, $T_j = 150^\circ C$,
 Dynamic test circuit in Figure E)

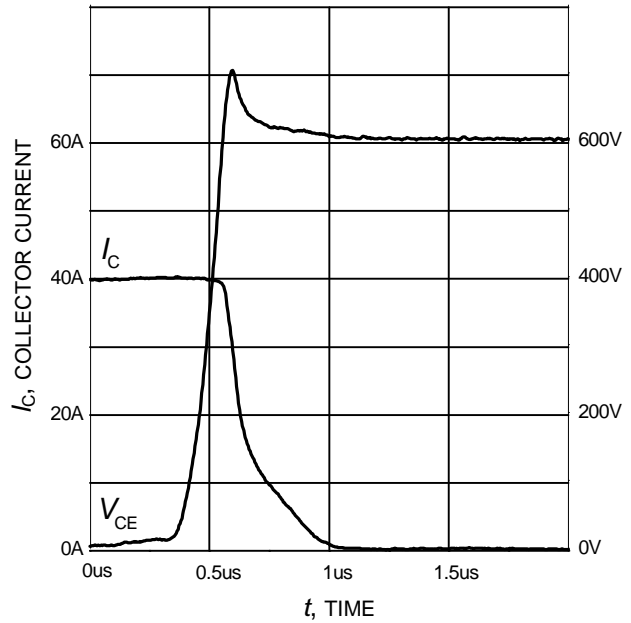

Figure 22. Typical turn off behavior
 ($V_{GE}=15/0V$, $R_G=15\Omega$, $T_j = 150^\circ C$,
 Dynamic test circuit in Figure E)

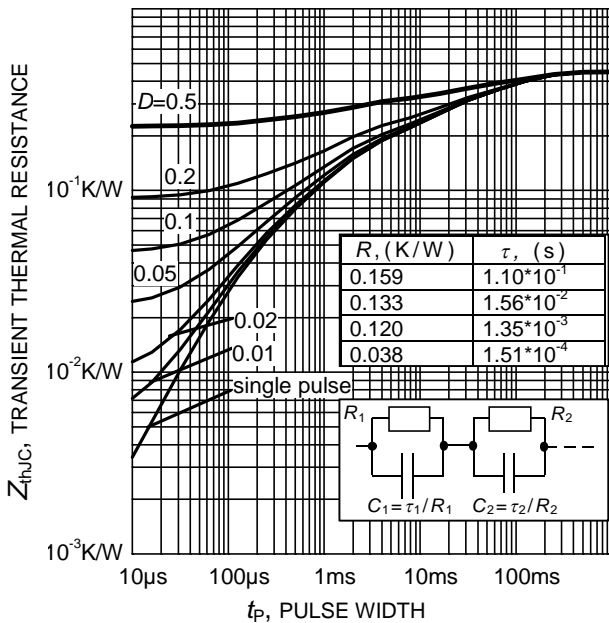
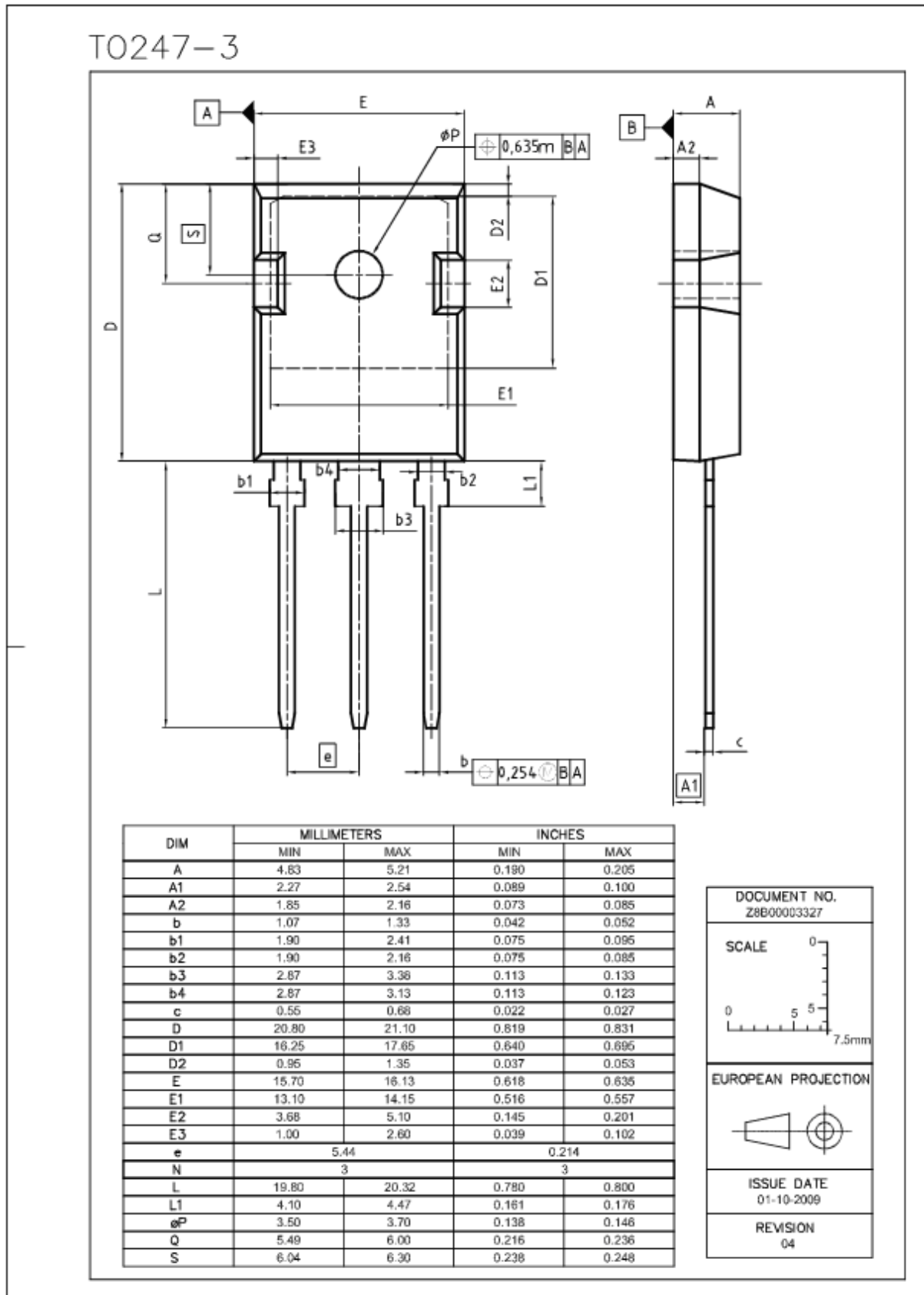

Figure 23. IGBT transient thermal resistance
 ($D = t_p / T$)

PG-TO247-3



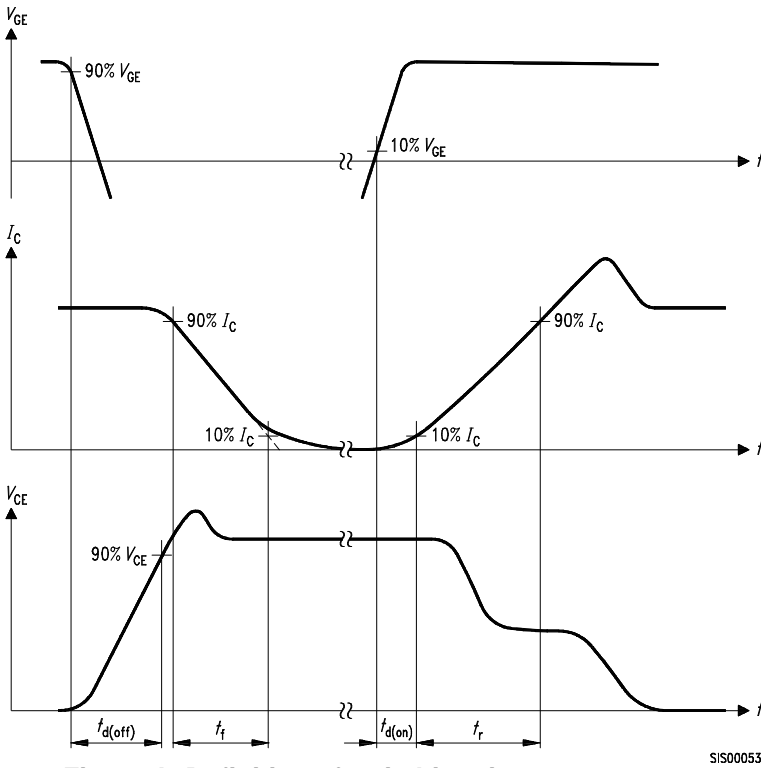

Figure A. Definition of switching times

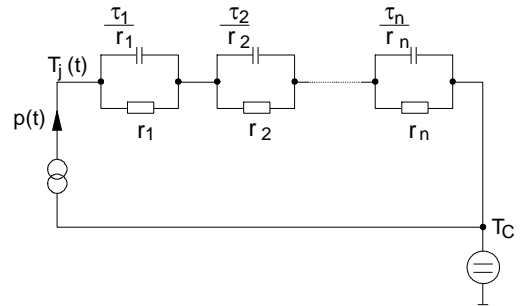

Figure D. Thermal equivalent circuit

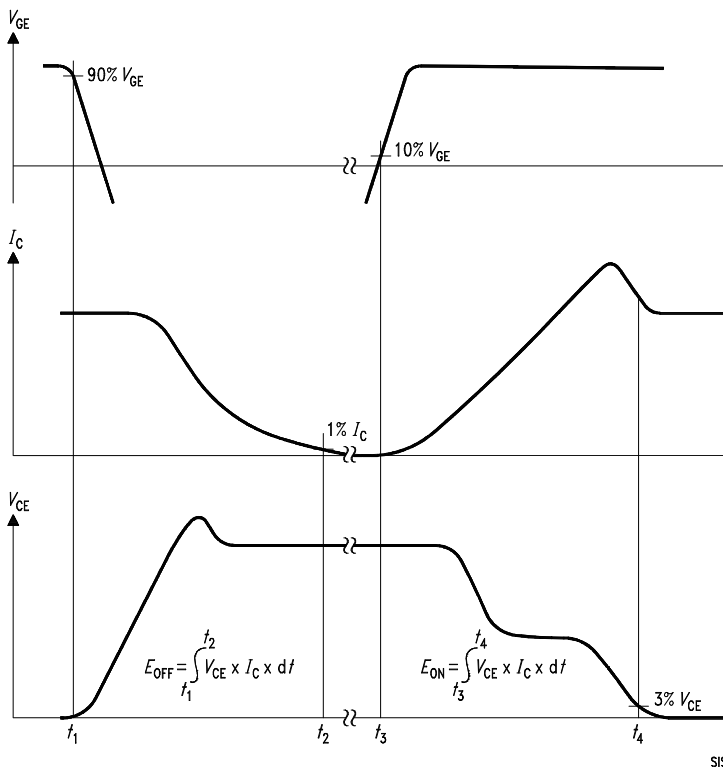

Figure B. Definition of switching losses

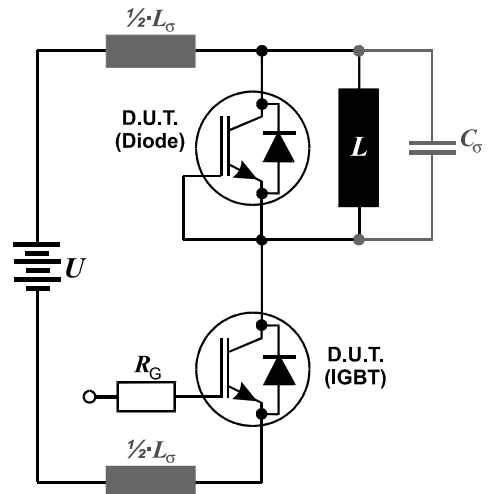

Figure E. Dynamic test circuit
Leakage inductance $L_{\sigma} = 180\text{nH}$
and Stray capacity $C_{\sigma} = 39\text{pF}$.



TrenchStop® Series

IGW40T120

Edition 2006-01

**Published by
Infineon Technologies AG
81726 München, Germany**

© Infineon Technologies AG 12/7/11.

All Rights Reserved.

Attention please!

The information given in this data sheet shall in no event be regarded as a guarantee of conditions or characteristics ("Beschaffenheitsgarantie"). With respect to any examples or hints given herein, any typical values stated herein and/or any information regarding the application of the device, Infineon Technologies hereby disclaims any and all warranties and liabilities of any kind, including without limitation warranties of non-infringement of intellectual property rights of any third party.

Information

For further information on technology, delivery terms and conditions and prices please contact your nearest Infineon Technologies Office (www.infineon.com).

Warnings

Due to technical requirements components may contain dangerous substances. For information on the types in question please contact your nearest Infineon Technologies Office.

Infineon Technologies Components may only be used in life-support devices or systems with the express written approval of Infineon Technologies, if a failure of such components can reasonably be expected to cause the failure of that life-support device or system, or to affect the safety or effectiveness of that device or system. Life support devices or systems are intended to be implanted in the human body, or to support and/or maintain and sustain and/or protect human life. If they fail, it is reasonable to assume that the health of the user or other persons may be endangered.



Стандарт Электрон Связь

Мы молодая и активно развивающаяся компания в области поставок электронных компонентов. Мы поставляем электронные компоненты отечественного и импортного производства напрямую от производителей и с крупнейших складов мира.

Благодаря сотрудничеству с мировыми поставщиками мы осуществляем комплексные и плановые поставки широчайшего спектра электронных компонентов.

Собственная эффективная логистика и склад в обеспечивает надежную поставку продукции в точно указанные сроки по всей России.

Мы осуществляем техническую поддержку нашим клиентам и предпродажную проверку качества продукции. На все поставляемые продукты мы предоставляем гарантию .

Осуществляем поставки продукции под контролем ВП МО РФ на предприятия военно-промышленного комплекса России , а также работаем в рамках 275 ФЗ с открытием отдельных счетов в уполномоченном банке. Система менеджмента качества компании соответствует требованиям ГОСТ ISO 9001.

Минимальные сроки поставки, гибкие цены, неограниченный ассортимент и индивидуальный подход к клиентам являются основой для выстраивания долгосрочного и эффективного сотрудничества с предприятиями радиоэлектронной промышленности, предприятиями ВПК и научно-исследовательскими институтами России.

С нами вы становитесь еще успешнее!

Наши контакты:

Телефон: +7 812 627 14 35

Электронная почта: sales@st-electron.ru

Адрес: 198099, Санкт-Петербург,
Промышленная ул, дом № 19, литера Н,
помещение 100-Н Офис 331