

Aluminum Capacitors Axial Miniature, Long-Life



Fig. 1

QUICK REFERENCE DATA		
DESCRIPTION	VALUE	
Nominal case sizes (\varnothing D x L in mm)	6.3 x 12.7 to 10 x 25	10 x 30 to 21 x 38
Rated capacitance range, C_R	1.0 μ F to 15 000 μ F	
Tolerance on C_R	\pm 20 %	
Rated voltage range, U_R	6.3 V to 100 V	
Category temperature range	- 40 °C to + 105 °C	
Endurance test at 105 °C	1000 h	5000 h
Useful life at 105 °C	2000 h	10 000 h
Useful life at 40 °C, I_R applied	1.3 x I_R applied: 200 000 h	1.8 x I_R applied: 500 000 h
Shelf life at 0 V, 105 °C	500 h	
Based on sectional specification	IEC 60384-4/EN130 300	
Climatic category IEC 60068	40/105/56	

FEATURES

- Polarized aluminum electrolytic capacitors, non-solid electrolyte
- Axial leads, cylindrical aluminum case, insulated with a blue sleeve (case \varnothing 6.3 mm x 12.7 mm and 7.7 mm x 12.7 mm are molded with flame retardant plastic material)
- Mounting ring version not available in insulated form
- Taped versions up to case \varnothing 15 mm x 30 mm available for automatic insertion
- Charge and discharge proof
- Long useful life: 2000 h to 10 000 h at 105 °C, high reliability
- High ripple current capability
- Miniaturized, high CV-product per unit volume
- Material categorization: For definitions of compliance please see www.vishay.com/doc?99912


**RoHS
COMPLIANT**

APPLICATIONS

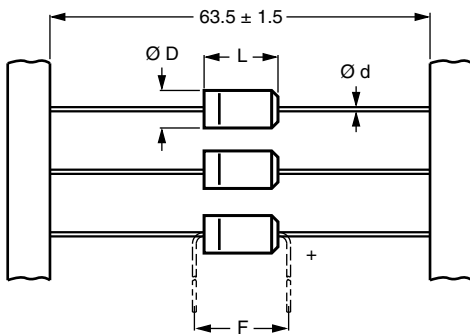
- Industrial, automotive, EDP and telecommunication
- Smoothing, filtering, buffering in SMPS; coupling, decoupling, timing
- Portable and mobile equipment (small size, low mass)
- Stand-by applications
- Low mounting height boards, vibration and shock resistant

MARKING

The capacitors are marked (where possible) with the following information:

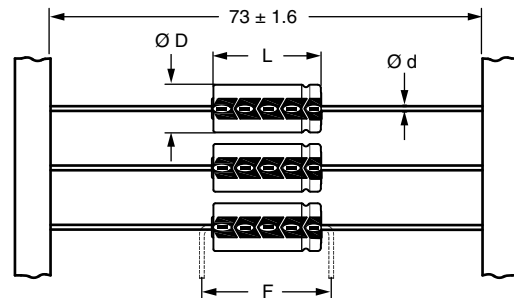
- Rated capacitance (in μ F)
- Tolerance on rated capacitance, code letter in accordance with IEC 60062 (M for \pm 20 %)
- Rated voltage (in V)
- Upper category temperature (105 °C)
- Date code, in accordance with IEC 60062
- Code for factory of origin
- Name of manufacturer
- Negative terminal identification
- Series number (138)

SELECTION CHART FOR C_R , U_R , AND RELEVANT NOMINAL CASE SIZES ($\varnothing D \times L$ in mm)								
C_R (μF)	U_R (V)							
	6.3	10	16	25	40	50	63	100
1.0	-	-	-	-	-	-	-	6.3 x 12.7
2.2	-	-	-	-	-	-	-	6.3 x 12.7
4.7	-	-	-	-	-	-	6.3 x 12.7	7.7 x 12.7
10	-	-	-	6.3 x 12.7	-	6.3 x 12.7	7.7 x 12.7	6.5 x 18
22	-	-	6.3 x 12.7	6.3 x 12.7	-	7.7 x 12.7	6.5 x 18	8 x 18
33	-	-	-	6.3 x 12.7	7.7 x 12.7	-	-	-
47	-	-	6.3 x 12.7	7.7 x 12.7	6.5 x 18	-	8 x 18	10 x 25
68	-	-	-	-	-	-	-	10 x 30
100	6.3 x 12.7	-	7.7 x 12.7	6.5 x 18	8 x 18	10 x 18	10 x 25	12.5 x 30
150	-	7.7 x 12.7	-	-	-	-	10 x 30	15 x 30
220	7.7 x 12.7	6.5 x 18	8 x 18	10 x 18	10 x 25	-	12.5 x 30	15 x 30
330	-	-	-	-	10 x 30	-	12.5 x 30	18 x 30
470	6.5 x 18	8 x 18	10 x 18	10 x 25	12.5 x 30	-	15 x 30	18 x 38
680	-	-	-	10 x 30	12.5 x 30	-	18 x 30	21 x 38
1000	10 x 18	10 x 25	10 x 30	12.5 x 30	15 x 30	-	18 x 38	-
1500	-	10 x 30	12.5 x 30	15 x 30	18 x 30	-	21 x 38	-
2200	10 x 25	12.5 x 30	15 x 30	18 x 30	18 x 38	-	-	-
3300	-	15 x 30	18 x 30	18 x 38	21 x 38	-	-	-
4700	-	18 x 30	18 x 30	18 x 38	-	-	-	-
6800	-	18 x 38	18 x 38	21 x 38	-	-	-	-
10 000	-	18 x 38	21 x 38	-	-	-	-	-
15 000	-	21 x 38	-	-	-	-	-	-

DIMENSIONS in millimeters AND AVAILABLE FORMS


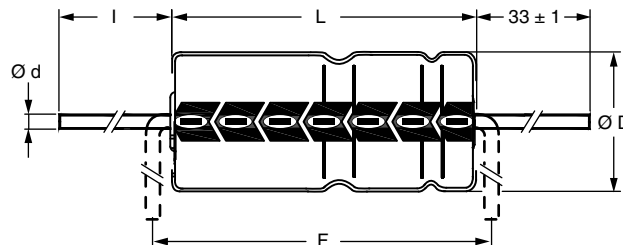
Form BR: Taped on reel
Form BA: Taped in box (ammopack)
 Case $\varnothing D \times L = 6.3 \text{ mm} \times 12.7 \text{ mm}$ to $7.7 \text{ mm} \times 12.7 \text{ mm}$

Fig. 2 - Forms BA and BR



Form BR: Taped on reel
 Case $\varnothing D \times L = 6.5 \text{ mm} \times 18 \text{ mm}$ to $15 \text{ mm} \times 30 \text{ mm}$
Form BA: Taped in box (ammopack)
 Case $\varnothing D \times L = 6.5 \text{ mm} \times 18 \text{ mm}$ to $10 \text{ mm} \times 25 \text{ mm}$

Fig. 3 - Forms BA and BR



Form AA: Axial in box
 Case $\varnothing D \times L = 10 \text{ mm} \times 30 \text{ mm}$ to $21 \text{ mm} \times 38 \text{ mm}$

Fig. 4 - Form AA

Table 1

AXIAL; DIMENSIONS in millimeters, MASS AND PACKAGING QUANTITIES										
NOMINAL CASE SIZE Ø D x L (mm)	CASE CODE	AXIAL: FORM AA, BA, AND BR					MASS (g)	PACKAGING QUANTITIES		
		Ø d	l	Ø D _{max.}	L _{max.}	F _{min.}		FORM AA	FORM BA	FORM BR
6.3 x 12.7	(2)	0.6	-	6.5	12.9	17.5	≈ 1.1	-	1000	1000
7.7 x 12.7	(3)	0.6	-	7.9	12.9	17.5	≈ 1.3	-	500	500
6.5 x 18	4	0.8	-	6.9	18.5	25	≈ 1.3	-	1000	1000
8 x 18	5	0.8	-	8.5	18.5	25	≈ 1.7	-	500	500
10 x 18	6	0.8	-	10.5	18.5	25	≈ 2.5	-	500	500
10 x 25	7	0.8	-	10.5	25.5	30	≈ 3.3	-	500	500
10 x 30	00	0.8	55 ± 1	10.5	30.5	35	≈ 4.8	340	-	500
12.5 x 30	01	0.8	55 ± 1	13.0	30.5	35	≈ 7.4	260	-	400
15 x 30	02	0.8	55 ± 1	15.5	30.5	35	≈ 11.7	200	-	250
18 x 30	03	0.8	55 ± 1	18.5	30.5	35	≈ 12.9	120	-	-
18 x 38	04	0.8	34 ± 1	18.5	39.5	44	≈ 19.0	125	-	-
21 x 38	05	0.8	34 ± 1	21.5	39.5	44	≈ 24.0	100	-	-

Note

- For detailed tape dimensions refer to packaging information: www.vishay.com/doc?28361

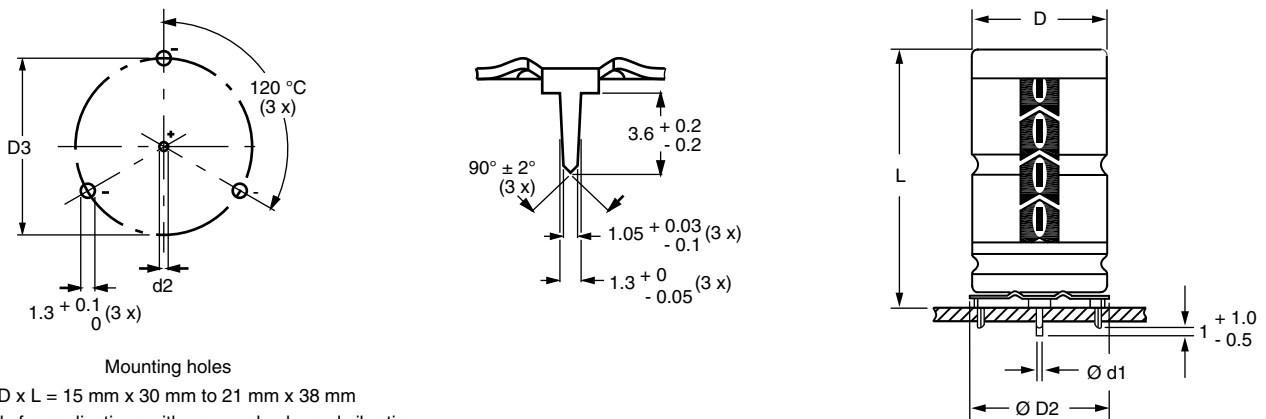

 Fig. 5 - Mounting hole diagram and outline; **Form MR:** With mounting ring and pins

Table 2

MOUNTING RING; DIMENSIONS in millimeters, MASS AND PACKAGING QUANTITIES									
NOMINAL CASE SIZE Ø D x L	CASE CODE	MOUNTING RING: FORM MR						MASS (g)	PACKAGING QUANTITIES
		Ø d1	Ø d2	D _{max.}	Ø D _{2max.}	D3	L _{max.}		
15 x 30	02	0.8	1.0 + 0.4	15.5	17.5	16.5 ± 0.2	33	≈ 11.7	200
18 x 30	03	0.8	1.0 + 0.4	18.5	19.5	18.5 ± 0.2	33	≈ 12.9	240
18 x 38	04	0.8	1.0 + 0.4	18.5	19.5	18.5 ± 0.2	42	≈ 19.0	100
21 x 38	05	0.8	1.0 + 0.4	21.5	22.5	21.5 ± 0.2	42	≈ 24.0	100



ELECTRICAL DATA	
SYMBOL	DESCRIPTION
C_R	Rated capacitance at 100 Hz, tolerance $\pm 20\%$
I_R	Rated RMS ripple current at 100 Hz, 105 °C
I_{L5}	Max. leakage current after 5 min at U_R
$\tan \delta$	Max. dissipation factor at 100 Hz
ESR	Equivalent series resistance at 100 Hz (calculated from $\tan \delta_{max}$ and C_R)
Z	Max. impedance at 10 kHz or 100 kHz

ORDERING EXAMPLE

Electrolytic capacitor 138 series
 470 $\mu\text{F}/10\text{ V}; \pm 20\%$
 Nominal case size: $\varnothing 8\text{ mm} \times 18\text{ mm}$; Form BA
 Ordering code: MAL213834471E3
 Former 12 NC: 2222 138 34471

Note

- Unless otherwise specified, all electrical values in Table 3 apply at $T_{amb} = 20\text{ °C}$, $P = 86\text{ kPa}$ to 106 kPa, $RH = 45\%$ to 75 %.

Table 3

ELECTRICAL DATA AND ORDERING INFORMATION												
U_R (V)	C_R 100 Hz (μF)	NOMINAL CASE SIZE $\varnothing D \times L$ (mm)	I_R 100 Hz 105 °C (mA)	I_{L5} 5 min (μA)	$\tan \delta$ 100 Hz	ESR 100 Hz (Ω)	Z 10 kHz (Ω)	Z 100 kHz (Ω)	ORDERING CODE MAL2138.....			
									IN BOX FORM AA	TAPED ON REEL FORM BR	TAPED IN BOX FORM BA	MOUNTING RING FORM MR
6.3	100	6.3 x 12.7	99	5.3	0.24	3.800	3.000	1.800	-	23101E3	33101E3	-
	220	7.7 x 12.7	160	6.8	0.24	1.700	1.400	0.950	-	23221E3	33221E3	-
	470	6.5 x 18	250	9.9	0.24	0.810	0.640	0.500	-	23471E3	33471E3	-
	1000	10 x 18	430	17	0.24	0.380	0.300	0.240	-	23102E3	33102E3	-
	2200	10 x 25	640	32	0.29	0.210	0.180	0.150	-	23222E3	33222E3	-
10	150	7.7 x 12.7	140	7.0	0.2	2.100	1.300	0.950	-	24151E3	34151E3	-
	220	6.5 x 18	190	8.4	0.2	1.400	0.910	0.500	-	24221E3	34221E3	-
	470	8 x 18	300	13	0.2	0.680	0.430	0.350	-	24471E3	34471E3	-
	1000	10 x 25	520	24	0.2	0.320	0.200	0.160	-	24102E3	34102E3	-
	1500	10 x 30	670	34	0.28	0.320	0.260	0.260	14152E3	24152E3	-	-
	2200	12.5 x 30	890	48	0.29	0.220	0.190	0.190	14222E3	24222E3	-	-
	3300	15 x 30	1140	70	0.30	0.160	0.130	0.150	14332E3	24332E3	-	44332E3
	4700	18 x 30	1450	98	0.33	0.120	0.110	0.130	14472E3	-	-	44472E3
	6800	18 x 38	1880	140	0.34	0.085	0.074	0.110	14682E3	-	-	44682E3
	10 000	18 x 38	1980	200	0.41	0.070	0.062	0.100	14103E3	-	-	44103E3
15 000	21 x 38	2200	300	0.55	0.063	0.058	0.099	14153E3	-	-	44153E3	
16	22	6.3 x 12.7	58	4.7	0.12	8.700	7.300	2.700	-	25229E3	35229E3	-
	47	6.3 x 12.7	83	5.5	0.16	5.400	3.400	1.900	-	25479E3	35479E3	-
	100	7.7 x 12.7	130	7.2	0.16	2.500	1.600	1.000	-	25101E3	35101E3	-
	220	8 x 18	230	11	0.16	1.200	0.730	0.350	-	25221E3	35221E3	-
	470	10 x 18	360	19	0.16	0.540	0.340	0.250	-	25471E3	35471E3	-
	1000	10 x 30	630	36	0.20	0.340	0.270	0.260	15102E3	25102E3	-	-
	1500	12.5 x 30	860	52	0.20	0.230	0.190	0.190	15152E3	25152E3	-	-
	2200	15 x 30	1090	74	0.21	0.170	0.140	0.150	15222E3	25222E3	-	45222E3
	3300	18 x 30	1420	110	0.24	0.120	0.100	0.130	15332E3	-	-	45332E3
	4700	18 x 30	1480	150	0.28	0.100	0.090	0.120	15472E3	-	-	45472E3
6800	18 x 38	1930	220	0.28	0.072	0.062	0.100	15682E3	-	-	45682E3	
10 000	21 x 38	2100	320	0.38	0.065	0.057	0.098	15103E3	-	-	45103E3	
25	10	6.3 x 12.7	46	4.5	0.09	14.000	12.000	2.800	-	26109E3	36109E3	-
	22	6.3 x 12.7	61	5.1	0.14	10.000	5.500	2.500	-	26229E3	36229E3	-
	33	6.3 x 12.7	74	5.7	0.14	6.800	3.600	1.900	-	26339E3	36339E3	-
	47	7.7 x 12.7	96	6.4	0.14	4.700	2.600	1.000	-	26479E3	36479E3	-



ELECTRICAL DATA AND ORDERING INFORMATION												
U _R (V)	C _R 100 Hz (μF)	NOMINAL CASE SIZE Ø D x L (mm)	I _R 100 Hz 105 °C (mA)	I _{L5} 5 min (μA)	tan δ 100 Hz	ESR 100 Hz (Ω)	Z 10 kHz (Ω)	Z 100 kHz (Ω)	ORDERING CODE MAL2138.....			
									IN BOX FORM AA	TAPED ON REEL FORM BR	TAPED IN BOX FORM BA	MOUNTING RING FORM MR
25	100	6.5 x 18	160	9.0	0.13	2.100	1.200	0.550	-	26101E3	36101E3	-
	220	10 x 18	270	15	0.13	0.940	0.550	0.270	-	26221E3	36221E3	-
	470	10 x 25	440	28	0.13	0.440	0.260	0.170	-	26471E3	36471E3	-
	680	10 x 30	580	38	0.14	0.360	0.260	0.250	16681E3	26681E3	-	-
	1000	12.5 x 30	790	54	0.15	0.250	0.180	0.190	16102E3	26102E3	-	-
	1500	15 x 30	1020	79	0.15	0.170	0.130	0.150	16152E3	26152E3	-	46152E3
	2200	18 x 30	1320	110	0.17	0.130	0.100	0.130	16222E3	-	-	46222E3
	3300	18 x 38	1720	170	0.17	0.090	0.071	0.110	16332E3	-	-	46332E3
	4700	18 x 38	1840	240	0.21	0.076	0.063	0.100	16472E3	-	-	46472E3
	6800	21 x 38	2100	340	0.27	0.068	0.058	0.099	16682E3	-	-	46682E3
40	33	7.7 x 12.7	91	6.6	0.11	5.300	2.700	1.000	-	27339E3	37339E3	-
	47	6.5 x 18	120	7.8	0.10	3.400	1.900	0.650	-	27479E3	37479E3	-
	100	8 x 18	180	12	0.10	1.600	0.900	0.400	-	27101E3	37101E3	-
	220	10 x 25	350	22	0.10	0.720	0.410	0.200	-	27221E3	37221E3	-
	330	10 x 30	490	30	0.09	0.470	0.320	0.300	17331E3	27331E3	-	-
	470	12.5 x 30	650	42	0.09	0.340	0.230	0.220	17471E3	27471E3	-	-
	680	12.5 x 30	750	58	0.10	0.250	0.180	0.180	17681E3	27681E3	-	-
	1000	15 x 30	970	84	0.10	0.170	0.120	0.140	17102E3	27102E3	-	47102E3
	1500	18 x 30	1250	120	0.12	0.130	0.098	0.120	17152E3	-	-	47152E3
	2200	18 x 38	1640	180	0.12	0.093	0.069	0.100	17222E3	-	-	47222E3
3300	21 x 38	1810	270	0.15	0.079	0.061	0.100	17332E3	-	-	47332E3	
50	10	6.3 x 12.7	51	5.0	0.09	14.00	7.000	2.700	-	21109E3	31109E3	-
	22	7.7 x 12.7	82	6.2	0.09	6.500	3.002	1.100	-	21229E3	31229E3	-
	100	10 x 18	230	14	0.08	1.300	0.700	0.300	-	21101E3	31101E3	-
63	4.7	6.3 x 12.7	35	4.6	0.09	30.00	17.000	5.000	-	28478E3	38478E3	-
	10	7.7 x 12.7	59	5.3	0.08	13.00	8.000	1.800	-	28109E3	38109E3	-
	22	6.5 x 18	100	6.8	0.07	5.100	3.600	0.850	-	28229E3	38229E3	-
	47	8 x 18	150	9.9	0.07	2.400	1.700	0.500	-	28479E3	38479E3	-
	100	10 x 25	280	17	0.07	1.100	0.800	0.270	-	28101E3	38101E3	-
	150	10 x 30	410	23	0.11	0.730	0.440	0.400	18151E3	28151E3	-	-
	220	12.5 x 30	560	32	0.11	0.500	0.310	0.290	18221E3	28221E3	-	-
	330	12.5 x 30	660	46	0.12	0.370	0.230	0.220	18331E3	28331E3	-	-
	470	15 x 30	860	63	0.12	0.260	0.160	0.160	18471E3	28471E3	-	48471E3
	680	18 x 30	1130	90	0.12	0.190	0.120	0.140	18681E3	-	-	48681E3
1000	18 x 38	1460	130	0.12	0.130	0.086	0.110	18102E3	-	-	48102E3	
1500	21 x 38	1680	190	0.13	0.100	0.072	0.110	18152E3	-	-	48152E3	
100	1.0	6.3 x 12.7	16	4.2	0.09	140.0	55.000	10.00	-	29108E3	39108E3	-
	2.2	6.3 x 12.7	24	4.4	0.09	65.00	25.000	8.000	-	29228E3	39228E3	-
	4.7	7.7 x 12.7	40	4.9	0.08	27.00	17.000	5.000	-	29478E3	39478E3	-
	10	6.5 x 18	67	6.0	0.07	11.00	8.000	2.400	-	29109E3	39109E3	-
	22	8 x 18	100	8.4	0.07	5.100	3.600	1.400	-	29229E3	39229E3	-
	47	10 x 25	190	13	0.07	2.400	1.700	0.670	-	29479E3	39479E3	-
	68	10 x 30	300	18	0.07	1.700	1.100	0.970	19689E3	29689E3	-	-
	100	12.5 x 30	410	24	0.07	1.100	0.770	0.670	19101E3	29101E3	-	-
	150	15 x 30	550	34	0.07	0.780	0.520	0.460	19151E3	29151E3	-	49151E3
	220	15 x 30	650	48	0.07	0.540	0.370	0.330	19221E3	29221E3	-	49221E3
	330	18 x 30	880	70	0.08	0.380	0.270	0.240	19331E3	-	-	49331E3
	470	18 x 38	1130	98	0.08	0.270	0.190	0.170	19471E3	-	-	49471E3
	680	21 x 38	1330	140	0.09	0.210	0.140	0.140	19681E3	-	-	49681E3

ADDITIONAL ELECTRICAL DATA			
PARAMETER	CONDITIONS	VALUE	
		AXIAL	MOUNTING RING
Voltage			
Surge voltage		$U_s \leq 1.15 \times U_R$	
Reverse voltage		$U_{rev} \leq 1 \text{ V}$	
Current			
Leakage current	After 1 min at U_R :		
	Case $\varnothing D \times L = 6.3 \text{ mm} \times 12.7 \text{ mm}$ and $7.7 \text{ mm} \times 12.7 \text{ mm}$	$I_{L1} \leq 0.02 C_R \times U_R + 3 \mu\text{A}$	
	Case $\varnothing D \times L = 6.5 \text{ mm} \times 18 \text{ mm}$ to $21 \text{ mm} \times 38 \text{ mm}$	$I_{L1} \leq 0.006 C_R \times U_R + 4 \mu\text{A}$	
	After 5 min at U_R	$I_{L5} \leq 0.002 C_R \times U_R + 4 \mu\text{A}$	
Inductance			
Equivalent series inductance (ESL)	Case $\varnothing D \times L$ mm:		
	6.3 x 12.7	Typ. 20 nH	-
	7.7 x 12.7	Typ. 30 nH	-
	6.5 x 18	Typ. 15 nH	-
	8 x 18	Typ. 35 nH	-
	10 x 18	Typ. 69 nH	-
	10 x 25	Typ. 38 nH	-
	10 x 30	Typ. 38 nH	-
	12.5 x 30	Typ. 46 nH	-
	15 x 30	Typ. 48 nH	Typ. 39 nH
	18 x 30	Typ. 50 nH	Typ. 39 nH
18 x 38	Typ. 54 nH	Typ. 39 nH	
21 x 38	Typ. 59 nH	Typ. 39 nH	

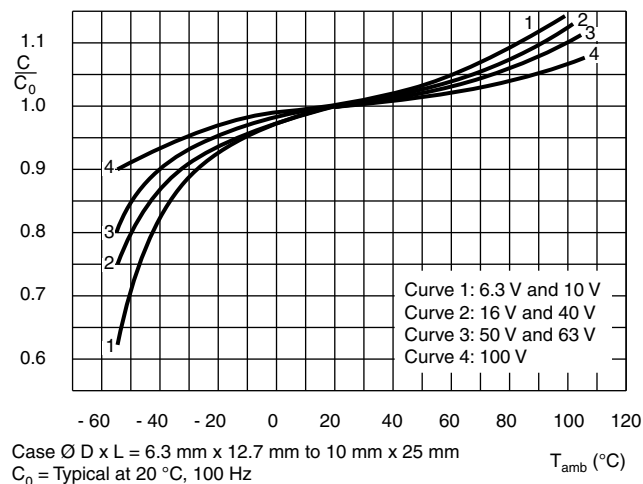
CAPACITANCE (C)


Fig. 6 - Typical multiplier of capacitance as a function of ambient temperature

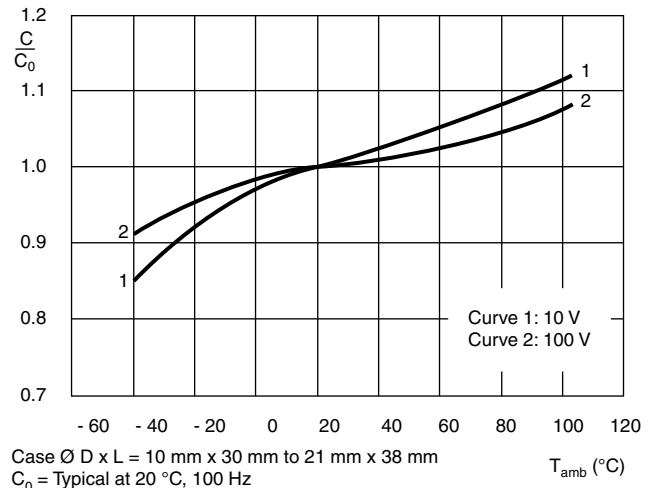


Fig. 7 - Typical multiplier of capacitance as a function of ambient temperature

EQUIVALENT SERIES RESISTANCE (ESR)

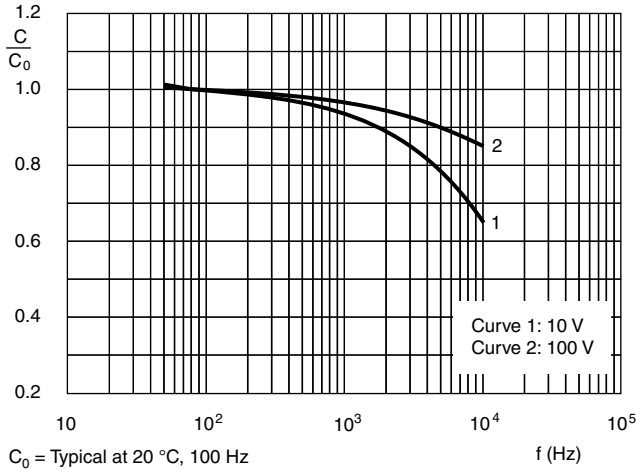


Fig. 8 - Typical multiplier of capacitance as a function of frequency

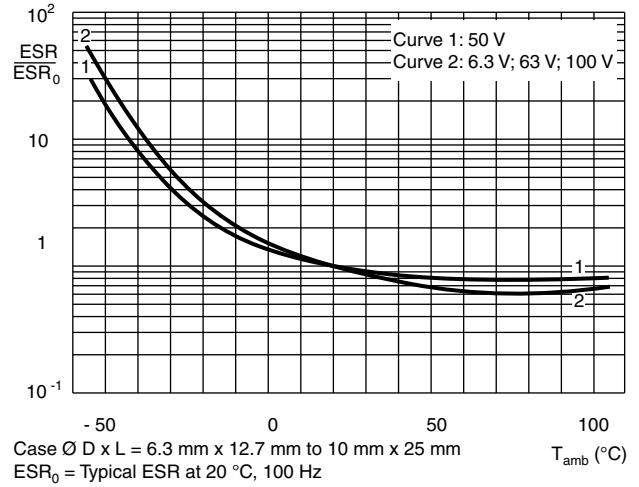


Fig. 9 - Typical multiplier of ESR as a function of ambient temperature

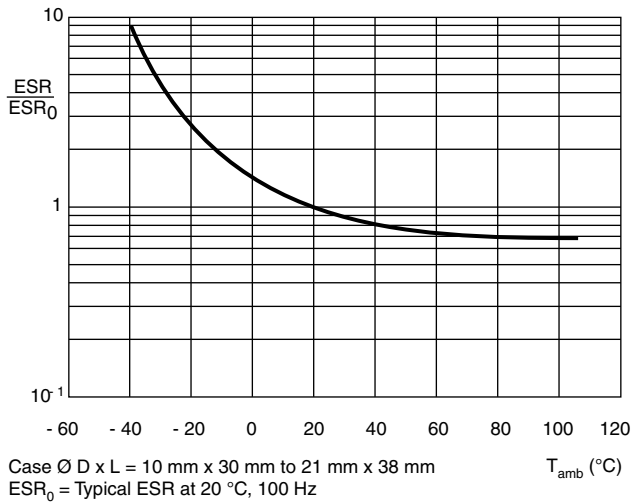


Fig. 10 - Typical multiplier of ESR as a function of ambient temperature

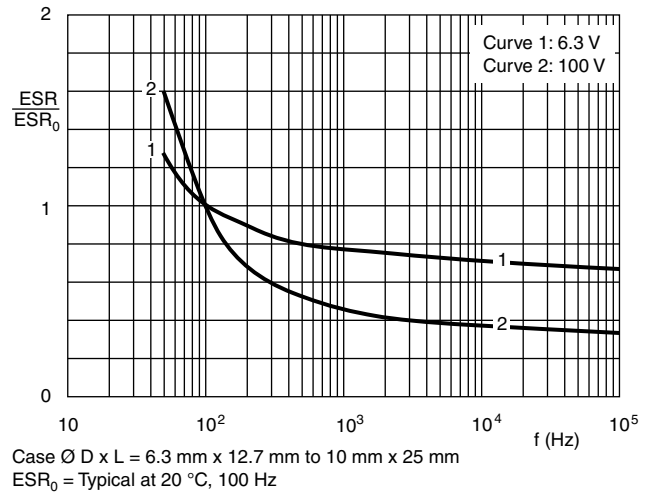


Fig. 11 - Typical multiplier ESR as a function of frequency

EQUIVALENT SERIES RESISTANCE (ESR)



Fig. 12 - Typical multiplier ESR as a function of frequency

IMPEDANCE (Z)

Table 4

IMPEDANCE VS. CAPACITANCE VALUES (Case \varnothing D x L = 6.3 mm x 12.7 mm to 10 mm x 25 mm)								
T_{amb}	Z x C_R (Ω x μF) AT 10 kHz							
	6.3 V	10 V	16 V	25 V	40 V	50 V	63 V	100 V
+ 20 °C	≤ 300	≤ 200	≤ 160	≤ 120	≤ 90	≤ 70	≤ 80	≤ 80
- 25 °C	≤ 2000	≤ 1200	≤ 750	≤ 560	≤ 450	≤ 300	≤ 550	≤ 550
- 40 °C	≤ 5500	≤ 3200	≤ 2000	≤ 1500	≤ 1200	≤ 900	≤ 1500	≤ 1500

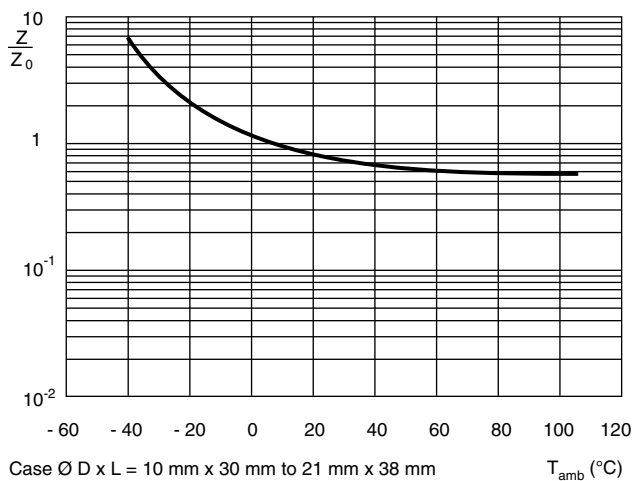


Fig. 13 - Typical multiplier of ESR as a function of ambient temperature at 10 kHz

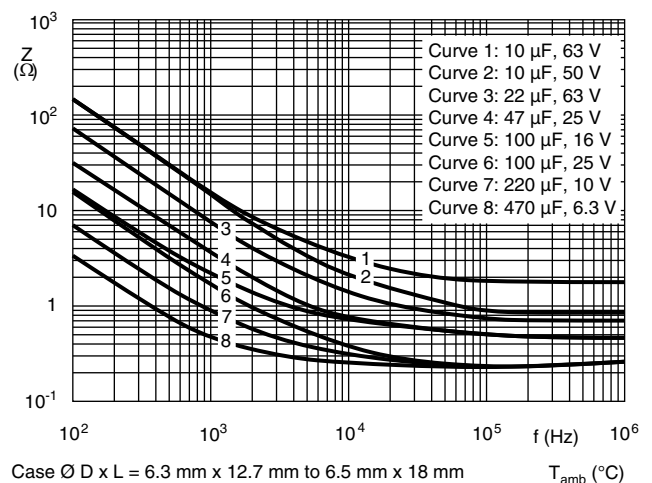


Fig. 14 - Typical impedance as a function of frequency

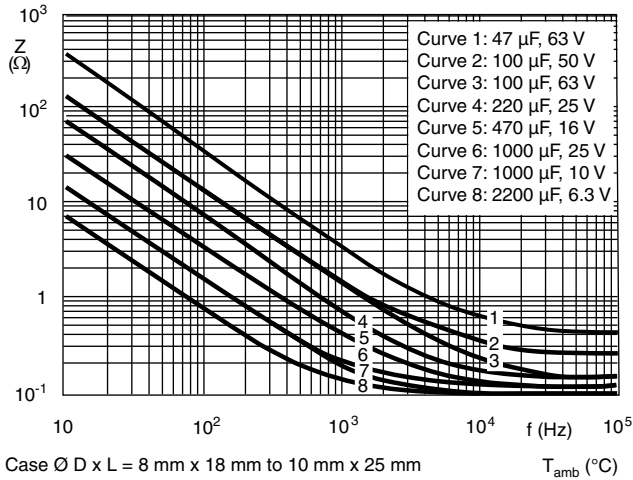


Fig. 15 - Typical impedance as a function of frequency

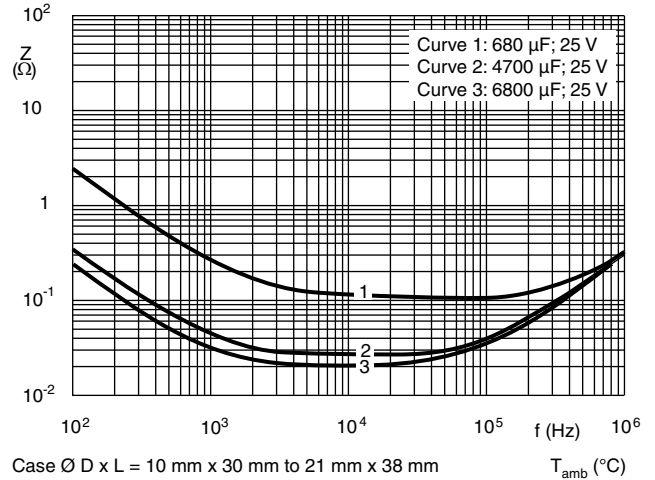


Fig. 16 - Typical impedance as a function of frequency

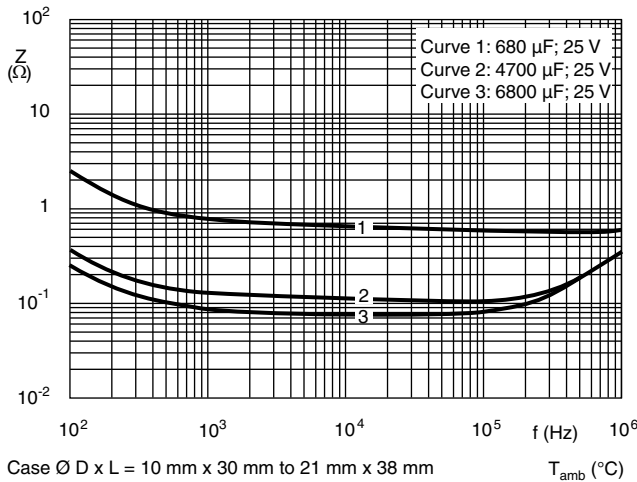


Fig. 17 - Typical impedance as a function of frequency

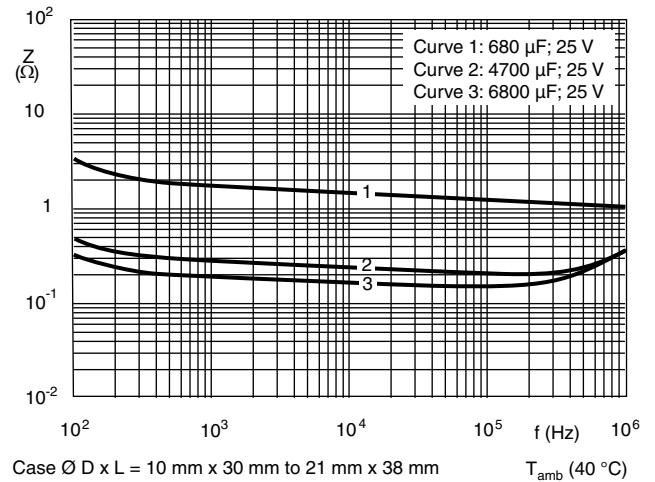
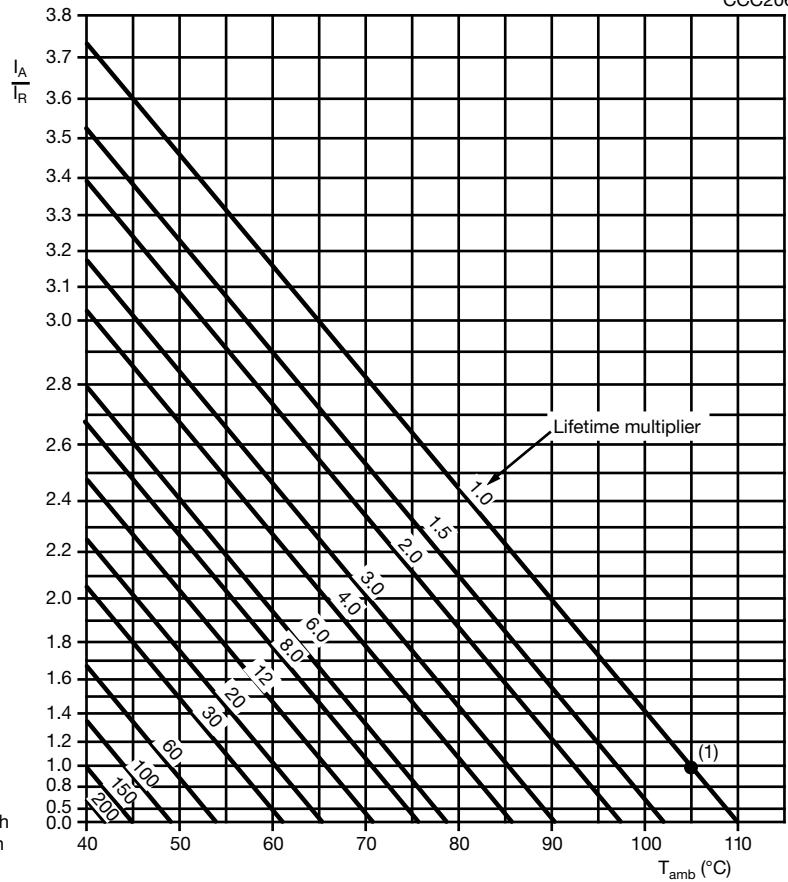


Fig. 18 - Typical impedance as a function of frequency

RIPPLE CURRENT AND USEFUL LIFE

CCC206



I_A = Actual ripple current at 100 Hz
 I_R = Rated ripple current at 100 Hz, 105 °C

(1) Useful life at 105 °C and I_R applied:
 Case $\varnothing D \times L = 6.3 \text{ mm} \times 12.7 \text{ mm}$ to $10 \text{ mm} \times 25 \text{ mm}$: 2000 h
 Case $\varnothing D \times L = 10 \text{ mm} \times 30 \text{ mm}$ to $21 \text{ mm} \times 38 \text{ mm}$: 10 000 h

Fig. 19 - Multiplier of useful life as a function of ambient temperature and ripple current load

Table 5

MULTIPLIER OF RIPPLE CURRENT (I_R) AS A FUNCTION OF FREQUENCY			
FREQUENCY (Hz)	I_R MULTIPLIER		
	$U_R = 6.3 \text{ V TO } 10 \text{ V}$	$U_R = 16 \text{ V TO } 25 \text{ V}$	$U_R = 40 \text{ V TO } 100 \text{ V}$
50	0.95	0.90	0.85
100	1.00	1.00	1.00
300	1.07	1.12	1.20
1000	1.12	1.20	1.30
3000	1.15	1.25	1.35
$\geq 10\ 000$	1.20	1.30	1.40

Table 6

TEST PROCEDURES AND REQUIREMENTS			
TEST		PROCEDURE (quick reference)	REQUIREMENTS
NAME OF TEST	REFERENCE		
Endurance	IEC 60384-4/ EN130300 subclause 4.13	$T_{amb} = 105\text{ }^{\circ}\text{C}$; U_R applied; Case $\emptyset D \times L$: 6.3 mm x 12.7 mm to 10 mm x 25 mm: 1000 h; 10 mm x 30 mm to 21 mm x 38 mm: 5000 h	$U_R \leq 6.3\text{ V}$; $\Delta C/C$: + 15 %/- 30 % $U_R > 6.3\text{ V}$; $\Delta C/C$: $\pm 15\%$ $\tan \delta \leq 1.3 \times \text{spec. limit}$ $Z \leq 2 \times \text{spec. limit}$ $I_{L5} \leq \text{spec. limit}$
Useful life	CECC 30301 subclause 1.8.1	$T_{amb} = 105\text{ }^{\circ}\text{C}$; U_R and I_R applied; Case $\emptyset D \times L$: 6.3 mm x 12.7 mm to 10 mm x 25 mm: 2000 h; 10 mm x 30 mm to 21 mm x 38 mm: 10 000 h	$U_R \leq 6.3\text{ V}$; $\Delta C/C$: + 45 %/- 50 % $U_R > 6.3\text{ V}$; $\Delta C/C$: $\pm 45\%$ $\tan \delta \leq 3 \times \text{spec. limit}$ $Z \leq 3 \times \text{spec. limit}$ $I_{L5} \leq \text{spec. limit}$ no short open circuit total failure percentage: $\leq 1\%$
Shelf life (storage at high temperature)	IEC 60384-4/ EN130300, subclause 4.17	$T_{amb} = 105\text{ }^{\circ}\text{C}$; no voltage applied; 500 h After test: U_R to be applied for 30 min, 24 h to 48 h before measurement	$\Delta C/C$, $\tan \delta$, Z : For requirements see "Endurance test" above $I_{L5} \leq 2 \times \text{spec. limit}$



Disclaimer

ALL PRODUCT, PRODUCT SPECIFICATIONS AND DATA ARE SUBJECT TO CHANGE WITHOUT NOTICE TO IMPROVE RELIABILITY, FUNCTION OR DESIGN OR OTHERWISE.

Vishay Intertechnology, Inc., its affiliates, agents, and employees, and all persons acting on its or their behalf (collectively, "Vishay"), disclaim any and all liability for any errors, inaccuracies or incompleteness contained in any datasheet or in any other disclosure relating to any product.

Vishay makes no warranty, representation or guarantee regarding the suitability of the products for any particular purpose or the continuing production of any product. To the maximum extent permitted by applicable law, Vishay disclaims (i) any and all liability arising out of the application or use of any product, (ii) any and all liability, including without limitation special, consequential or incidental damages, and (iii) any and all implied warranties, including warranties of fitness for particular purpose, non-infringement and merchantability.

Statements regarding the suitability of products for certain types of applications are based on Vishay's knowledge of typical requirements that are often placed on Vishay products in generic applications. Such statements are not binding statements about the suitability of products for a particular application. It is the customer's responsibility to validate that a particular product with the properties described in the product specification is suitable for use in a particular application. Parameters provided in datasheets and/or specifications may vary in different applications and performance may vary over time. All operating parameters, including typical parameters, must be validated for each customer application by the customer's technical experts. Product specifications do not expand or otherwise modify Vishay's terms and conditions of purchase, including but not limited to the warranty expressed therein.

Except as expressly indicated in writing, Vishay products are not designed for use in medical, life-saving, or life-sustaining applications or for any other application in which the failure of the Vishay product could result in personal injury or death. Customers using or selling Vishay products not expressly indicated for use in such applications do so at their own risk. Please contact authorized Vishay personnel to obtain written terms and conditions regarding products designed for such applications.

No license, express or implied, by estoppel or otherwise, to any intellectual property rights is granted by this document or by any conduct of Vishay. Product names and markings noted herein may be trademarks of their respective owners.

Material Category Policy

Vishay Intertechnology, Inc. hereby certifies that all its products that are identified as RoHS-Compliant fulfill the definitions and restrictions defined under Directive 2011/65/EU of The European Parliament and of the Council of June 8, 2011 on the restriction of the use of certain hazardous substances in electrical and electronic equipment (EEE) - recast, unless otherwise specified as non-compliant.

Please note that some Vishay documentation may still make reference to RoHS Directive 2002/95/EC. We confirm that all the products identified as being compliant to Directive 2002/95/EC conform to Directive 2011/65/EU.

Vishay Intertechnology, Inc. hereby certifies that all its products that are identified as Halogen-Free follow Halogen-Free requirements as per JEDEC JS709A standards. Please note that some Vishay documentation may still make reference to the IEC 61249-2-21 definition. We confirm that all the products identified as being compliant to IEC 61249-2-21 conform to JEDEC JS709A standards.



Стандарт Электрон Связь

Мы молодая и активно развивающаяся компания в области поставок электронных компонентов. Мы поставляем электронные компоненты отечественного и импортного производства напрямую от производителей и с крупнейших складов мира.

Благодаря сотрудничеству с мировыми поставщиками мы осуществляем комплексные и плановые поставки широчайшего спектра электронных компонентов.

Собственная эффективная логистика и склад в обеспечивает надежную поставку продукции в точно указанные сроки по всей России.

Мы осуществляем техническую поддержку нашим клиентам и предпродажную проверку качества продукции. На все поставляемые продукты мы предоставляем гарантию .

Осуществляем поставки продукции под контролем ВП МО РФ на предприятия военно-промышленного комплекса России , а также работаем в рамках 275 ФЗ с открытием отдельных счетов в уполномоченном банке. Система менеджмента качества компании соответствует требованиям ГОСТ ISO 9001.

Минимальные сроки поставки, гибкие цены, неограниченный ассортимент и индивидуальный подход к клиентам являются основой для выстраивания долгосрочного и эффективного сотрудничества с предприятиями радиоэлектронной промышленности, предприятиями ВПК и научно-исследовательскими институтами России.

С нами вы становитесь еще успешнее!

Наши контакты:

Телефон: +7 812 627 14 35

Электронная почта: sales@st-electron.ru

Адрес: 198099, Санкт-Петербург,
Промышленная ул, дом № 19, литера Н,
помещение 100-Н Офис 331