

General Description

The MAX2150 evaluation kit (EV kit) simplifies testing of the MAX2150 complete wideband I/Q modulator chip. The kit allows evaluation of the I/Q modulator, synthesizer, 3-wire programming interface, and power-management features. The EV kit provides 50Ω connectors for all signal inputs and outputs.

Component Suppliers

SUPPLIERS	WEBSITE
AVX Corp.	www.avxcorp.com
Coilcraft, Inc.	www.coilcraft.com
Murata Americas	www.murataamericas.com

Component List

DESIGNATION	QTY	DESCRIPTION
BUFEN	1	3-pin header, 100 mil centers Digi-Key S1012-36-ND
C1–C3, C12, C18, C28, C30, C31, C34, C36, C37, C50, C52	13	0.1μF ±10% capacitors (0603) Murata GRM188R71C104K
C4, C9–C11, C13, C35	6	100pF ±5% capacitors (0402) Murata GRP1555C1H101J
C5, C6, C7, C15, C16	5	Open
C8	1	22pF ±5% capacitor (0402) Murata GRP1555C1H220J
C14, C17	2	100pF ±5% capacitors (0603) Murata GRM1885C1H101J
C19–C21, C32, C33	5	0.1μF ±10% capacitors (0402) Murata GRP155R61A104K
C22	1	6800pF ±10% capacitor (0402) Murata GRP155R71E682K
C23	1	0.068μF ±10% capacitor (0402) Murata GRP155R61A683K

Features

- 3-Wire Interface
- Differential Baseband Inputs
- 2.7V to 3.6V Single-Supply Operation
- 50Ω Connectors on All Signal Ports
- Low-Power Shutdown Mode
- PC Control Software
(Available at www.maximintegrated.com)

Ordering Information

PART	TYPE
MAX2150EVKIT	EV Kit

DESIGNATION	QTY	DESCRIPTION
C24	1	680pF ±10% capacitor (0402) Murata GRP155R71H681K
C25	1	1μF ±10% tantalum capacitor, case A AVX TAJA105K016
C26	1	470pF ±10% capacitor (0402) Murata GRP155R71H471K
C27	1	1.0μF ±10% capacitor (0603) Murata GRM188R60J105K
DCIN, \overline{EN}	2	Test points Digi-Key 5000-ND
J1, J3	2	50Ω BNC connectors, 31 series, Amphenol Allied Electronics 31-5329-52RFX 713-9041
J5–J7, J11, J16, J17, J19, J20, VCCSD	9	2-pin headers, 100 mil centers Digi-Key S1012-36-ND
J8, J13–J15, J18 (Note 1)	5	SMA connectors, edge mount EFJohnson 142-0701-801
J10	1	10-pin header Digi-Key S2012-36-ND

Component List (continued)

DESIGNATION	QTY	DESCRIPTION
J19, J20, BUFEN, VCCSD	4	Shunt-shorting jumpers Digi-Key S9000-ND
L1	0	Not installed, inductor
R1–R4, R29, R35	0	Not installed, resistors
R12	1	0Ω ±5% resistor (0402)
R13, R18	2	0Ω ±5% resistors (0603)
R23	1	245Ω ±5% resistor (0402)
R24, R25	2	1.1kΩ ±1% resistors (0402)
R31–R34	4	3.3kΩ ±5% resistors (0603)

DESIGNATION	QTY	DESCRIPTION
U1 (Note 2)	1	Wideband I/Q modulator (28 TQFN) Maxim MAX2150ETI+
U2	1	VCO Fujitsu VC-3R0A23-0967/1750B
VTUNE_OUT	1	SMA connectors, PC mount EFJohnson 142-0701-201
Y1	1	20MHz surface-mount crystal CTS Reeves Digi-Key ATS200SM CTX515TR-ND
—	1	PCB: MAX2150 EVALUATION KIT Rev 3

Note 1: Cut center pin to approximately 1/16in long.

Note 2: This IC has an exposed pad. It must be solder attached to the circuit board to ensure proper function.

Connector Descriptions

CONNECTOR	NAME	DESCRIPTION	DC VOLTAGE RANGE
J1, J3	I, Q	I/Q baseband input BNC connectors	—
J5, J19	VCCVCO	V _{CC} to on-board VCO	2.7V ~ 3.6V
J6	VCC	Supply voltage	2.7V ~ 3.6V
J7, J11	GND	Ground	—
J8	RFOUT	RF output (SMA)	—
J10	—	Interface connection	2.7V ~ 3.6V
J13	BUFOUT	Buffer output (SMA)	—
J14, J15	LO	External LO input (SMA)	—
J16, J17	N.C.	No connection	—
J18	REFL IN	Reference input (SMA)	—
J20	LOCK	Lock signal output	—
—	BUFEN	Buffer enable	—
—	DCIN	Bias voltage input	1.6V
—	EN	Enable pin input	—
—	TUNE_OUT	Tuning voltage output	—
—	VCCSD	V _{CC} to sigma-delta modulator	2.7V ~ 3.6V

Quick Start

The MAX2150 EV kit is fully assembled and factory tested. Follow the instructions in the *Connections and Setup* section.

Test Equipment Required

This section lists the recommended test equipment to verify the operation of the MAX2150. It is intended as a guide only, and substitutions are possible.

- MAX2150 EV kit
- One RF signal generator capable of delivering -7dBm of output power in the 10MHz to 50MHz frequency range (HP 8648A or equivalent) for the PLL reference frequency
- RF spectrum analyzer capable of measuring up to 7GHz RF signal (Rohde & Schwarz FSEA20 or equivalent)
- RF power meter capable of measuring up to +10dBm output power (HP 437B or equivalent) with an RF sensor
- RF network analyzer
- Oscilloscope
- Two power supplies that can provide 250mA at +5.0V (AG E3631A or equivalent)
- Arbitrary waveform generator (HP E4433B or equivalent)
- PC laptop or tablet with Microsoft Windows XP®, Windows® 7, 8 OS and a USB port
- USB-A male to USB-B male cable
- US keyboard

Connections and Setup

This section provides step-by-step instructions for getting the EV kit up and running in all operation modes.

- 1) Verify that jumpers are in place.
- 2) Connect the PC to the INTF3000 interface board using the USB-A male to USB-B male cable. On INTF3000, remove jumper JU1 and connect a DC supply set to +3V to the VPULL connector. Connect a 20-pin ribbon cable between the INTF3000 board (J3_INTF2300) and the EV kit (J10), keeping the pin 1 to pin 1 connections.
- 3) Set the power supply to +3V and turn it off.

Windows and Windows XP are registered trademarks and registered service marks of Microsoft Corporation.

- 4) Set the adjustable power supply to +1.6V and turn it off.
- 5) Connect the ground terminal to GND.
- 6) Connect the positive +3V terminal to VCC and VCCVCO.
- 7) Connect the positive terminal of the adjustable power supply to pin DCIN on the board.
- 8) Set the I/Q generator to 330kHz, with an input level of 1V_{p-p}. Leave the I/Q generator output off.
- 9) Using 2 BNC cables, connect the output of the I/Q generator to the I/Q input connectors on the MAX2150 EV kit board.
- 10) Use an SMA cable to connect the RFOUT to the input of the spectrum analyzer.
- 11) Set the spectrum analyzer to view the output.
- 12) Turn on all power supplies and enable I/Q signal generator.
- 13) Measure the supply current level.
- 14) Observe the RF output frequency as displayed on the spectrum analyzer. Measure the RF output power.
- 15) The RF output power should be approximately -4dBm after accounting for cable and connector loss.

Adjustments and Control

Operation Modes

- 1) TX mode
- 2) SYNTH mode
- 3) MOD mode
- 4) Software shutdown mode
- 5) Hardware shutdown mode

Refer to the MAX2150 data sheet for details.

Layout Issues

A good PCB is an essential part of an RF circuit design. The EV kit PCB can serve as a guide for laying out a board using the MAX2150. Keep traces carrying RF signals as short as possible to minimize radiation and insertion loss. Use impedance control on all RF signal traces. The VCC node on the PCB should have decoupling capacitors to the closest ground. Refer to the *Layout* section of the MAX2150 data sheet for more information.

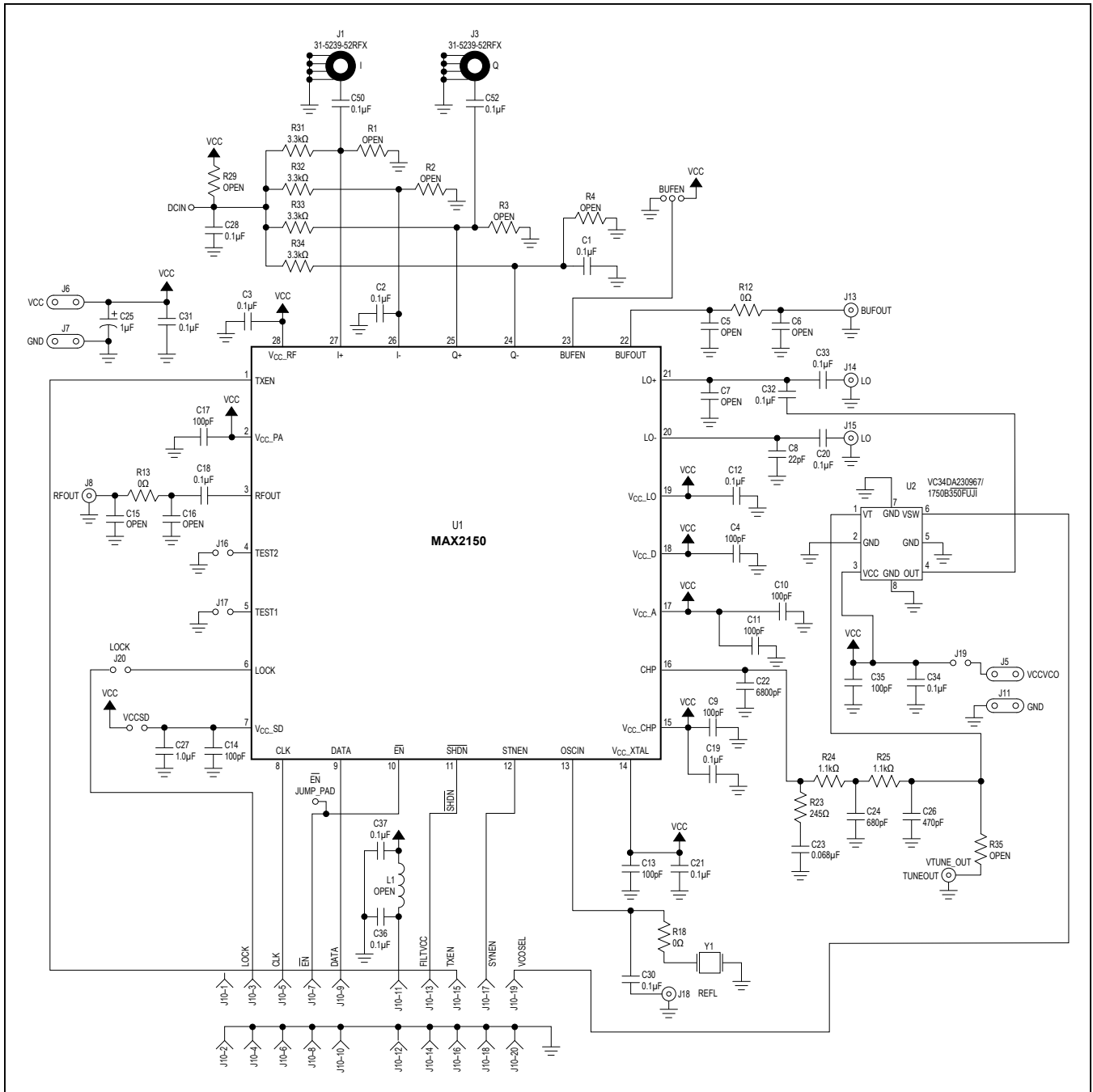

Figure 1. MAX2150 EV Kit Schematic

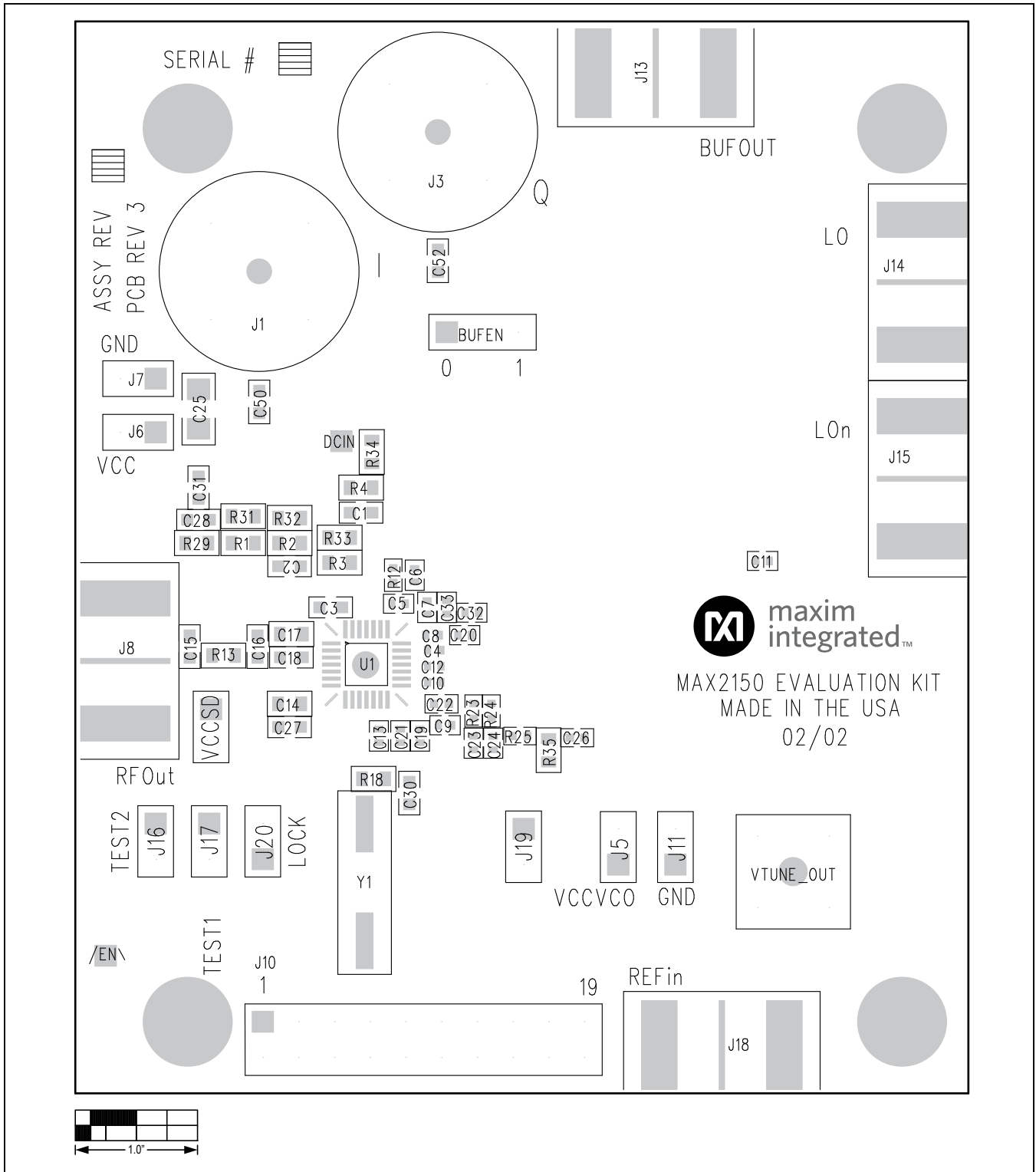

Figure 2. MAX2150 EV Kit Primary-Side Silkscreen

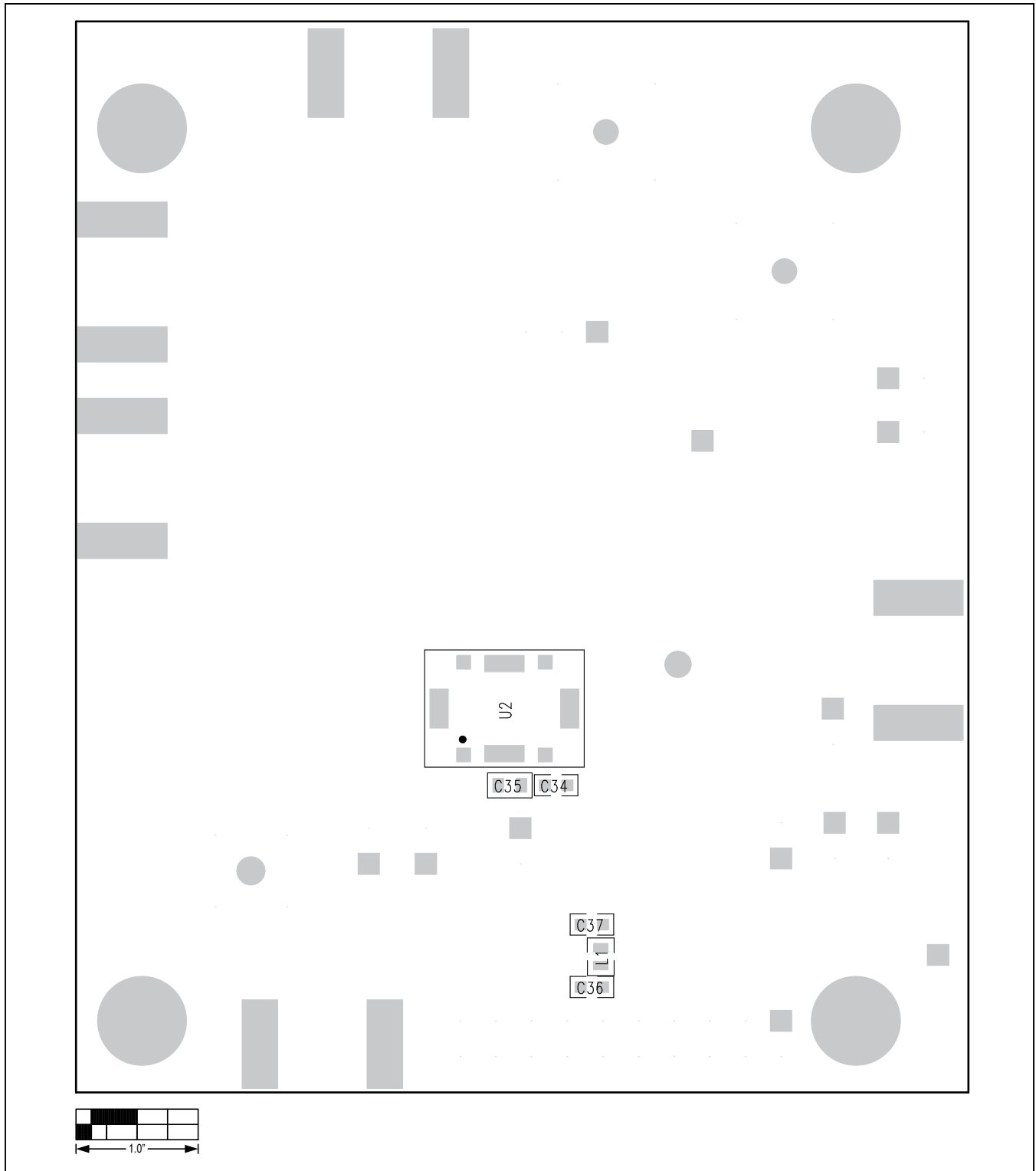

Figure 3. MAX2150 EV Kit Secondary-Side Silkscreen

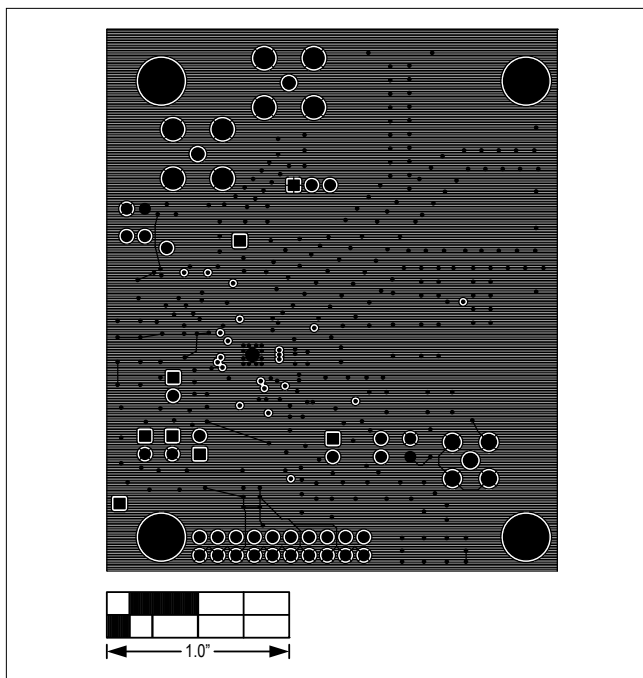

Figure 4. MAX2150 EV Kit PCB Layout—Layer 2

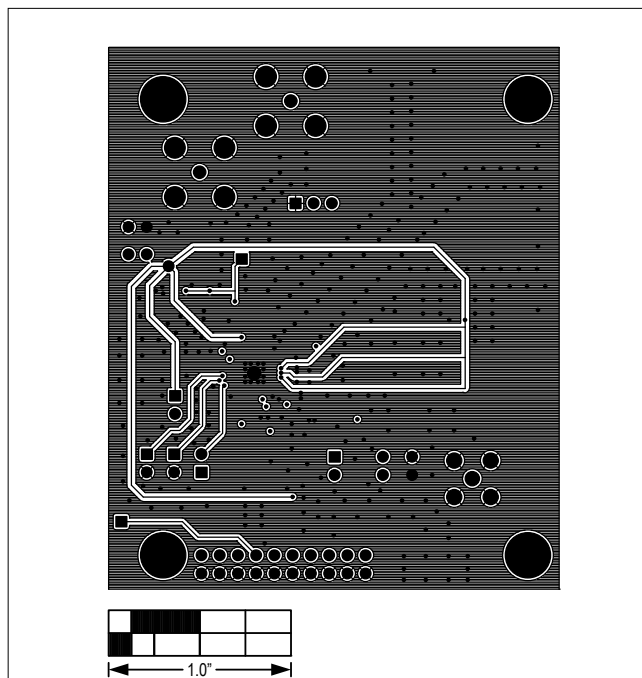

Figure 5. MAX2150 EV Kit PCB Layout—Layer 3

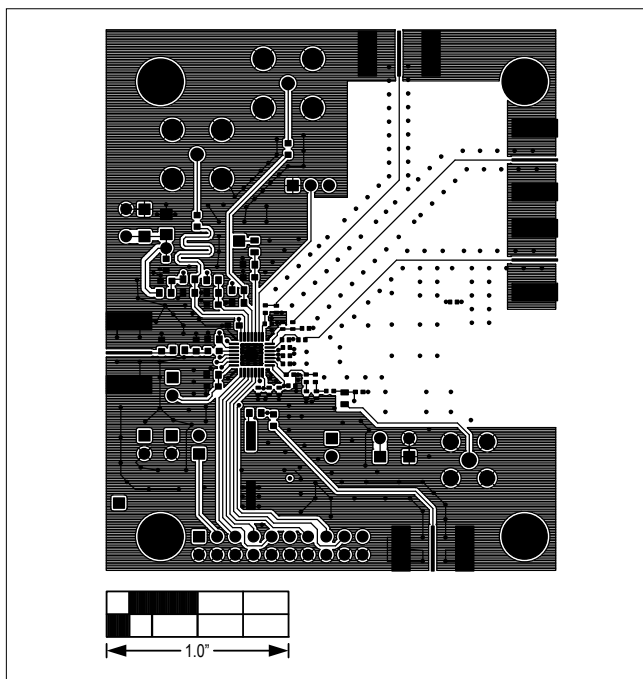

Figure 6. MAX2150 EV Kit Primary Component Side

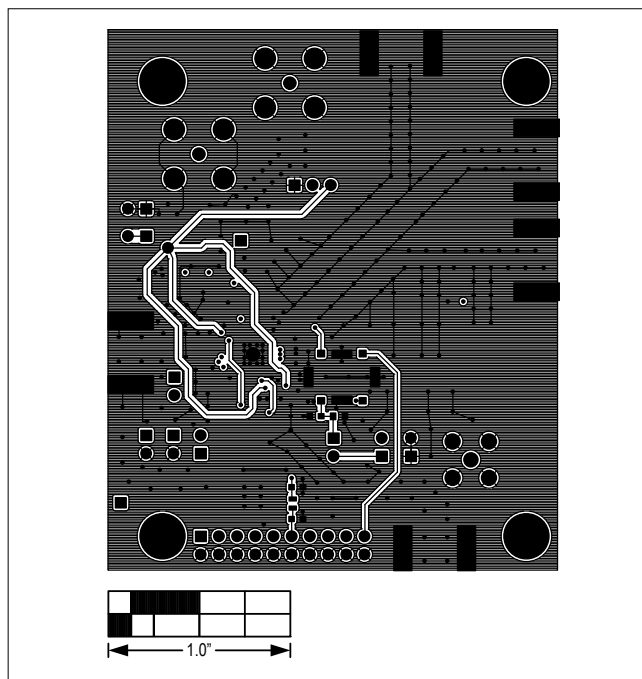

Figure 7. MAX2150 EV Kit Secondary Side

Revision History

REVISION NUMBER	REVISION DATE	DESCRIPTION	PAGES CHANGED
0	8/02	Initial release	—
1	11/14	Updated <i>Quick Start</i> section and added <i>Revision History</i> table	2, 8
2	6/15	Updated <i>Component List</i>	2

For pricing, delivery, and ordering information, please contact Maxim Direct at 1-888-629-4642, or visit Maxim Integrated's website at www.maximintegrated.com.

Maxim Integrated cannot assume responsibility for use of any circuitry other than circuitry entirely embodied in a Maxim Integrated product. No circuit patent licenses are implied. Maxim Integrated reserves the right to change the circuitry and specifications without notice at any time.



Стандарт Электрон Связь

Мы молодая и активно развивающаяся компания в области поставок электронных компонентов. Мы поставляем электронные компоненты отечественного и импортного производства напрямую от производителей и с крупнейших складов мира.

Благодаря сотрудничеству с мировыми поставщиками мы осуществляем комплексные и плановые поставки широчайшего спектра электронных компонентов.

Собственная эффективная логистика и склад в обеспечивает надежную поставку продукции в точно указанные сроки по всей России.

Мы осуществляем техническую поддержку нашим клиентам и предпродажную проверку качества продукции. На все поставляемые продукты мы предоставляем гарантию .

Осуществляем поставки продукции под контролем ВП МО РФ на предприятия военно-промышленного комплекса России , а также работаем в рамках 275 ФЗ с открытием отдельных счетов в уполномоченном банке. Система менеджмента качества компании соответствует требованиям ГОСТ ISO 9001.

Минимальные сроки поставки, гибкие цены, неограниченный ассортимент и индивидуальный подход к клиентам являются основой для выстраивания долгосрочного и эффективного сотрудничества с предприятиями радиоэлектронной промышленности, предприятиями ВПК и научно-исследовательскими институтами России.

С нами вы становитесь еще успешнее!

Наши контакты:

Телефон: +7 812 627 14 35

Электронная почта: sales@st-electron.ru

Адрес: 198099, Санкт-Петербург,
Промышленная ул, дом № 19, литера Н,
помещение 100-Н Офис 331