



# 4.5Ω/20Ω, 300MHz Bandwidth, Dual SPDT Analog Switches in UCSP

MAX4717/MAX4718

## General Description

The MAX4717/MAX4718 low-voltage, low on-resistance ( $R_{ON}$ ), dual single-pole/double throw (SPDT) analog switches operate from a single +1.8V to +5.5V supply. These devices are designed for USB 1.1 and audio switching applications.

The MAX4717 features two 4.5Ω  $R_{ON}$  (max) SPDT switches with 1.2Ω flatness and 0.3Ω matching between channels. The MAX4718 features one 4.5Ω  $R_{ON}$  (max) SPDT switch and one 20Ω  $R_{ON}$  (max) SPDT switch. The 20Ω switch has a guaranteed matching and flatness of 0.4Ω and 1.2Ω, respectively. These switches offer break-before-make switching (1ns) with  $t_{ON} < 80ns$  and  $t_{OFF} < 40ns$  at +2.7V. The digital logic inputs are +1.8V logic compatible with a +2.7V to +3.6V supply.

These switches are packaged in a chip-scale package (UCSP™), significantly reducing the required PC board area. The chip occupies only a 2.0mm × 1.50mm area and has a 4 × 3 bump array with a bump pitch of 0.5mm. These switches are also available in 10-pin μMAX® and 10-pin TDFN packages.

## Applications

- USB 1.1 Signal Switching Circuits
- Battery-Operated Equipment
- Audio/Video-Signal Routing
- Headphone Switching
- Low-Voltage Data-Acquisition Systems
- Sample-and-Hold Circuits
- Cell Phones
- PDA's

UCSP is a trademark of Maxim Integrated Products, Inc.  
 μMAX is a registered trademark of Maxim Integrated Products, Inc.

## Features

- ◆ USB 1.1 Signal Switching Compliant (TID = 4000231)
- ◆ 2ns (max) Differential Skew
- ◆ -3dB Bandwidth: > 300MHz
- ◆ Low 15pF On-Channel Capacitance
- ◆ Single-Supply Operation from +1.8V to +5.5V
- ◆ 4.5Ω  $R_{ON}$  (max) Switches (MAX4717/MAX4718)  
 0.3Ω (max)  $R_{ON}$  Match (+3.0V Supply)  
 1.2Ω (max) Flatness (+3.0V Supply)
- ◆ 20Ω  $R_{ON}$  (max) Switch (MAX4718)  
 0.4Ω (max)  $R_{ON}$  Match (+3.0V Supply)  
 1.2Ω (max) Flatness (+3.0V Supply)
- ◆ Rail-to-Rail Signal Handling
- ◆ High Off-Isolation: -55dB (10MHz)
- ◆ Low Crosstalk: -80dB (10MHz)
- ◆ Low Distortion: 0.03%
- ◆ +1.8V CMOS-Logic Compatible
- ◆ < 0.5nA Leakage Current at +25°C

## Ordering Information

PART	TEMP RANGE	PIN/BUMP-PACKAGE	TOP MARK
MAX4717EUB	-40°C to +85°C	10 μMAX	—
MAX4717ETB	-40°C to +85°C	10 TDFN-EP*	ACV
MAX4717EBC-T	-40°C to +85°C	12 UCSP-12	ABH
MAX4718EUB	-40°C to +85°C	10 μMAX	—
MAX4718ETB	-40°C to +85°C	10 TDFN-EP*	ACW
MAX4718EBC-T	-40°C to +85°C	12 UCSP-12	ABI

\*EP = Exposed paddle.

## Pin Configurations/Functional Diagrams/Truth Tables

TOP VIEW  
(BUMP SIDE DOWN)

MAX4717/MAX4718  
UCSP

MAX4717/MAX4718  
TDFN

PART	SPDT1	SPDT2
MAX4717	4.5Ω	4.5Ω
MAX4718	4.5Ω	20Ω

MAX4717/MAX4718		
IN_	NO_	NC_
0	OFF	ON
1	ON	OFF

SWITCHES SHOWN FOR LOGIC "0" INPUT

MAX4717/MAX4718  
μMAX



For pricing, delivery, and ordering information, please contact Maxim/Dallas Direct! at 1-888-629-4642, or visit Maxim's website at [www.maxim-ic.com](http://www.maxim-ic.com).

# 4.5Ω/20Ω, 300MHz Bandwidth, Dual SPDT Analog Switches in UCSP

## ABSOLUTE MAXIMUM RATINGS

(All voltages are referenced to GND.)

V+, IN_	-0.3V to +6.0V
COM_, NO_, NC_ (Note 1)	-0.3V to (V+ + 0.3V)
Continuous Current COM_, NO_, NC_	±100mA
Peak Current COM_, NO_, NC_ (pulsed at 1ms, 10% duty cycle)	±200mA
Continuous Power Dissipation (T <sub>A</sub> = +70°C)	
10-Pin μMAX (derate 5.6mW/°C above +70°C)	444mW
10-Pin TDFN (derate 24.4mW/°C above +70°C)	1951mW
12-Bump UCSP (derate 11.4mW/°C above +70°C)	909mW

ESD Method 3015.7	>2kV
Operating Temperature Range	-40°C to +85°C
Junction Temperature	+150°C
Storage Temperature Range	-65°C to +150°C
Lead Temperature (soldering, 10s)	+300°C
Bump Temperature (soldering)	
Infrared (15s)	+220°C
Vapor Phase (60s)	+215°C

**Note 1:** Signals on COM\_, NO\_, or NC\_ exceeding V+ or GND are clamped by internal diodes. Limit forward-diode current to maximum current rating.

Stresses beyond those listed under "Absolute Maximum Ratings" may cause permanent damage to the device. These are stress ratings only, and functional operation of the device at these or any other conditions beyond those indicated in the operational sections of the specifications is not implied. Exposure to absolute maximum rating conditions for extended periods may affect device reliability.

## ELECTRICAL CHARACTERISTICS—Single +3V Supply

(V+ = +2.7V to +3.6V, V<sub>IH</sub> = +1.4V, V<sub>IL</sub> = +0.5V, T<sub>A</sub> = T<sub>MIN</sub> to T<sub>MAX</sub>, unless otherwise noted. Typical values are at V+ = +3.0V, T<sub>A</sub> = +25°C, unless otherwise noted.) (Notes 2, 3)

PARAMETER	SYMBOL	CONDITIONS	T <sub>A</sub>	MIN	TYP	MAX	UNITS
Analog Signal Range	V <sub>COM_</sub> , V <sub>NO_</sub> , V <sub>NC_</sub>		T <sub>MIN</sub> to T <sub>MAX</sub>	0		V+	V
<b>ANALOG SWITCH (Low R<sub>ON</sub>—MAX4717/MAX4718 SPDT 1)</b>							
On-Resistance (Note 4)	R <sub>ON</sub>	V+ = 2.7V, I <sub>COM_</sub> = 10mA; V <sub>NO_</sub> or V <sub>NC_</sub> = 1.5V	+25°C		3.0	4.5	Ω
			T <sub>MIN</sub> to T <sub>MAX</sub>			5	
On-Resistance Match Between Channels (Notes 4, 5)	ΔR <sub>ON</sub>	V+ = 2.7V, I <sub>COM_</sub> = 10mA; V <sub>NO_</sub> or V <sub>NC_</sub> = 1.5V	+25°C		0.1	0.3	Ω
			T <sub>MIN</sub> to T <sub>MAX</sub>			0.4	
On-Resistance Flatness (Note 6)	R <sub>FLAT(ON)</sub>	V+ = 2.7V, I <sub>COM_</sub> = 10mA; V <sub>NO_</sub> or V <sub>NC_</sub> = 1.0V, 1.5V, 2.0V	+25°C		0.6	1.2	Ω
			T <sub>MIN</sub> to T <sub>MAX</sub>			1.5	
NO_, NC_ Off-Leakage Current (Note 7)	I <sub>NO_(OFF)</sub> , I <sub>NC_(OFF)</sub>	V+ = 3.6V, V <sub>COM_</sub> = 0.3V, 3.3V; V <sub>NO_</sub> or V <sub>NC_</sub> = 3.3V, 0.3V	+25°C	-0.5	+0.01	+0.5	nA
			T <sub>MIN</sub> to T <sub>MAX</sub>	-1		+1	
COM_ On-Leakage Current (Note 7)	I <sub>COM_(ON)</sub>	V+ = 3.6V, V <sub>COM_</sub> = 0.3V, 3.3V; V <sub>NO_</sub> or V <sub>NC_</sub> = 0.3V, 3.3V, or floating	+25°C	-1	+0.01	+1	nA
			T <sub>MIN</sub> to T <sub>MAX</sub>	-2		+2	
<b>ANALOG SWITCH (High R<sub>ON</sub>—MAX4718 SPDT 2)</b>							
On-Resistance (Note 4)	R <sub>ON</sub>	V+ = 2.7V, I <sub>COM_</sub> = 10mA; V <sub>NO_</sub> or V <sub>NC_</sub> = 1.5V	+25°C		15	20	Ω
			T <sub>MIN</sub> to T <sub>MAX</sub>			25	

# 4.5Ω/20Ω, 300MHz Bandwidth, Dual SPDT Analog Switches in UCSP

MAX4717/MAX4718

## ELECTRICAL CHARACTERISTICS—Single +3V Supply (continued)

(V+ = +2.7V to +3.6V, V<sub>IH</sub> = +1.4V, V<sub>IL</sub> = +0.5V, T<sub>A</sub> = T<sub>MIN</sub> to T<sub>MAX</sub>, unless otherwise noted. Typical values are at V+ = +3.0V, T<sub>A</sub> = +25°C, unless otherwise noted.) (Notes 2, 3)

PARAMETER	SYMBOL	CONDITIONS	T <sub>A</sub>	MIN	TYP	MAX	UNITS
On-Resistance Match Between Channels (Notes 4, 5)	ΔRON	V+ = 2.7V, I <sub>COM_</sub> = 10mA; V <sub>NO_</sub> or V <sub>NC_</sub> = 1.5V	+25°C	0.15	0.4		Ω
			T <sub>MIN</sub> to T <sub>MAX</sub>			0.5	
On-Resistance Flatness (Note 6)	R <sub>FLAT(ON)</sub>	V+ = 2.7V, I <sub>COM_</sub> = 10mA; V <sub>NO_</sub> or V <sub>NC_</sub> = 1.0V, 1.5V, 2.0V	+25°C	0.6	1.2		Ω
			T <sub>MIN</sub> to T <sub>MAX</sub>			1.5	
NO_, NC_ Off-Leakage Current (Note 7)	I <sub>NO_(OFF)</sub> , I <sub>NC_(OFF)</sub>	V+ = 3.6V, V <sub>COM_</sub> = 0.3V, 3.3V; V <sub>NO_</sub> or V <sub>NC_</sub> = 3.3V, 0.3V	+25°C	-0.5	+0.01	+0.5	nA
			T <sub>MIN</sub> to T <sub>MAX</sub>	-1		+1	
COM_ On-Leakage Current (Note 7)	I <sub>COM_(ON)</sub>	V+ = 3.6V, V <sub>COM_</sub> = 0.3V, 3.3V; V <sub>NO_</sub> or V <sub>NC_</sub> = 0.3V, 3.3V, or floating	+25°C	-1	+0.01	+1	nA
			T <sub>MIN</sub> to T <sub>MAX</sub>	-2		+2	
<b>DYNAMIC CHARACTERISTICS</b>							
Turn-On Time	t <sub>ON</sub>	V <sub>NO_</sub> , V <sub>NC_</sub> = 1.5V; R <sub>L</sub> = 300Ω, C <sub>L</sub> = 35pF, Figure 1; V <sub>IH</sub> = 1.5V, V <sub>IL</sub> = 0V	+25°C	40	80		ns
			T <sub>MIN</sub> to T <sub>MAX</sub>			100	
Turn-Off Time	t <sub>OFF</sub>	V <sub>NO_</sub> , V <sub>NC_</sub> = 1.5V; R <sub>L</sub> = 300Ω, C <sub>L</sub> = 35pF, Figure 1; V <sub>IH</sub> = 1.5V, V <sub>IL</sub> = 0V	+25°C	20	40		ns
			T <sub>MIN</sub> to T <sub>MAX</sub>			50	
Break-Before-Make Time Delay (Note 7)	t <sub>BBM</sub>	V <sub>NO_</sub> , V <sub>NC_</sub> = 1.5V; R <sub>L</sub> = 300Ω, C <sub>L</sub> = 35pF, Figure 2	+25°C		8		ns
			T <sub>MIN</sub> to T <sub>MAX</sub>	1			
Skew (Note 7)	t <sub>SKEW</sub>	R <sub>S</sub> = 39Ω, C <sub>L</sub> = 50pF, Figure 3	T <sub>MIN</sub> to T <sub>MAX</sub>	0.15	2		ns
Charge Injection	Q	V <sub>GEN</sub> = 1.5V, R <sub>GEN</sub> = 0Ω, C <sub>L</sub> = 1.0nF, Figure 4	+25°C		5		pC
Off-Isolation	V <sub>ISO</sub>	f = 10MHz; V <sub>NO_</sub> , V <sub>NC_</sub> = 1V <sub>P-P</sub> ; R <sub>L</sub> = 50Ω, C <sub>L</sub> = 5pF, Figure 5	+25°C		-55		dB
				f = 1MHz; V <sub>NO_</sub> , V <sub>NC_</sub> = 1V <sub>P-P</sub> ; R <sub>L</sub> = 50Ω, C <sub>L</sub> = 5pF, Figure 5		-80	
Crosstalk (Note 8)	V <sub>CT</sub>	f = 10MHz; V <sub>NO_</sub> , V <sub>NC_</sub> = 1V <sub>P-P</sub> ; R <sub>L</sub> = 50Ω, C <sub>L</sub> = 5pF, Figure 5	+25°C		-80		dB
				f = 1MHz; V <sub>NO_</sub> , V <sub>NC_</sub> = 1V <sub>P-P</sub> ; R <sub>L</sub> = 50Ω, C <sub>L</sub> = 5pF, Figure 5		-110	
On-Channel -3dB Bandwidth	BW	Signal = 0dBm, R <sub>L</sub> = 50Ω, C <sub>L</sub> = 5pF, Figure 5	+25°C		>300		MHz
Total Harmonic Distortion	THD	V <sub>COM_</sub> = 2V <sub>P-P</sub> , R <sub>L</sub> = 600Ω	+25°C		0.03		%
NO_, NC_ Off-Capacitance	C <sub>NO_(OFF)</sub> , C <sub>NC_(OFF)</sub>	f = 1MHz, Figure 6	+25°C		9		pF

## 4.5Ω/20Ω, 300MHz Bandwidth, Dual SPDT Analog Switches in UCSP

### ELECTRICAL CHARACTERISTICS—Single +3V Supply (continued)

(V<sub>+</sub> = +2.7V to +3.6V, V<sub>IH</sub> = +1.4V, V<sub>IL</sub> = +0.5V, T<sub>A</sub> = T<sub>MIN</sub> to T<sub>MAX</sub>, unless otherwise noted. Typical values are at V<sub>+</sub> = +3.0V, T<sub>A</sub> = +25°C, unless otherwise noted.) (Notes 2, 3)

PARAMETER	SYMBOL	CONDITIONS	T <sub>A</sub>	MIN	TYP	MAX	UNITS
Switch On-Capacitance	C <sub>(ON)</sub>	f = 1MHz, Figure 6	+25°C		15		pF
<b>DIGITAL I/O</b>							
Input Logic High Voltage	V <sub>IH</sub>		T <sub>MIN</sub> to T <sub>MAX</sub>	1.4			V
Input Logic Low Voltage	V <sub>IL</sub>		T <sub>MIN</sub> to T <sub>MAX</sub>			0.5	V
Input Leakage Current	I <sub>IN</sub>	V <sub>+</sub> = +3.6V, V <sub>IN_</sub> = 0 or 5.5V	T <sub>MIN</sub> to T <sub>MAX</sub>	-100		+100	nA
<b>POWER SUPPLY</b>							
Power-Supply Range	V <sub>+</sub>		T <sub>MIN</sub> to T <sub>MAX</sub>	1.8		5.5	V
Supply Current	I <sub>+</sub>	V <sub>+</sub> = +5.5V, V <sub>IN_</sub> = 0V or V <sub>+</sub>	T <sub>MIN</sub> to T <sub>MAX</sub>			1	μA

### ELECTRICAL CHARACTERISTICS—Single +5V Supply

(V<sub>+</sub> = +4.2V to +5.5V, V<sub>IH</sub> = +2.0V, V<sub>IL</sub> = +0.8V, T<sub>A</sub> = T<sub>MIN</sub> to T<sub>MAX</sub>, unless otherwise noted. Typical values are at V<sub>+</sub> = +5.0V, T<sub>A</sub> = +25°C, unless otherwise noted.) (Notes 2, 3)

PARAMETER	SYMBOL	CONDITIONS	T <sub>A</sub>	MIN	TYP	MAX	UNITS
Analog Signal Range	V <sub>COM_</sub> , V <sub>NO_</sub> , V <sub>NC_</sub>		T <sub>MIN</sub> to T <sub>MAX</sub>	0		V <sub>+</sub>	V
<b>ANALOG SWITCH (Low R<sub>ON</sub>—MAX4717/MAX4718 SPDT 1)</b>							
On-Resistance (Note 4)	R <sub>ON</sub>	V <sub>+</sub> = 4.2V, I <sub>COM_</sub> = 10mA; V <sub>NO_</sub> or V <sub>NC_</sub> = 3.5V	+25°C		1.7	3	Ω
			T <sub>MIN</sub> to T <sub>MAX</sub>			3.5	
On-Resistance Match Between Channels (Notes 4, 5)	ΔR <sub>ON</sub>	V <sub>+</sub> = 4.2V, I <sub>COM_</sub> = 10mA; V <sub>NO_</sub> or V <sub>NC_</sub> = 3.5V	+25°C		0.1	0.3	Ω
			T <sub>MIN</sub> to T <sub>MAX</sub>			0.4	
On-Resistance Flatness (Note 6)	R <sub>FLAT(ON)</sub>	V <sub>+</sub> = 4.2V, I <sub>COM_</sub> = 10mA; V <sub>NO_</sub> or V <sub>NC_</sub> = 1.0V, 2.0V, 3.5V	+25°C		0.4	1.2	Ω
			T <sub>MIN</sub> to T <sub>MAX</sub>			1.5	
NO <sub>_</sub> , NC <sub>_</sub> Off-Leakage Current (Note 7)	I <sub>NO_(OFF)</sub> , I <sub>NC_(OFF)</sub>	V <sub>+</sub> = 5.5V; V <sub>COM_</sub> = 1.0V, 4.5V; V <sub>NO_</sub> or V <sub>NC_</sub> = 1.0V, 4.5V	+25°C	-0.5	+0.01	+0.5	nA
			T <sub>MIN</sub> to T <sub>MAX</sub>	-1		+1	
COM <sub>_</sub> On-Leakage Current (Note 7)	I <sub>COM_(ON)</sub>	V <sub>+</sub> = 5.5V; V <sub>COM_</sub> = 1.0V, 4.5V; V <sub>NO_</sub> or V <sub>NC_</sub> = 1.0V, 4.5V, or floating	+25°C	-1	+0.01	+1	nA
			T <sub>MIN</sub> to T <sub>MAX</sub>	-2		+2	

# 4.5Ω/20Ω, 300MHz Bandwidth, Dual SPDT Analog Switches in UCSP

MAX4717/MAX4718

## ELECTRICAL CHARACTERISTICS—Single +5V Supply (continued)

(V+ = +4.2V to +5.5V, V<sub>IH</sub> = +2.0V, V<sub>IL</sub> = +0.8V, T<sub>A</sub> = T<sub>MIN</sub> to T<sub>MAX</sub>, unless otherwise noted. Typical values are at V+ = +5.0V, T<sub>A</sub> = +25°C, unless otherwise noted.) (Notes 2, 3)

PARAMETER	SYMBOL	CONDITIONS	T <sub>A</sub>	MIN	TYP	MAX	UNITS
<b>ANALOG SWITCH (High R<sub>ON</sub>—MAX4718 SPDT 2)</b>							
On-Resistance (Note 4)	R <sub>ON</sub>	V+ = 4.2V, I <sub>COM_</sub> = 10mA; V <sub>NO_</sub> or V <sub>NC_</sub> = 3.5V	+25°C	12	20		Ω
			T <sub>MIN</sub> to T <sub>MAX</sub>			25	
On-Resistance Match Between Channels (Notes 4, 5)	ΔR <sub>ON</sub>	V+ = 4.2V, I <sub>COM_</sub> = 10mA; V <sub>NO_</sub> or V <sub>NC_</sub> = 3.5V	+25°C	0.15	0.4		Ω
			T <sub>MIN</sub> to T <sub>MAX</sub>			0.5	
On-Resistance Flatness (Note 6)	R <sub>FLAT(ON)</sub>	V+ = 4.2V, I <sub>COM_</sub> = 10mA; V <sub>NO_</sub> or V <sub>NC_</sub> = 1.0V, 2.0V, 4.5V	+25°C	0.4	1.2		Ω
			T <sub>MIN</sub> to T <sub>MAX</sub>			1.5	
NO <sub>_</sub> , NC <sub>_</sub> Off-Leakage Current (Note 7)	I <sub>NO_(OFF)</sub> , I <sub>NC_(OFF)</sub>	V+ = 5.5V; V <sub>COM_</sub> = 1.0V, 4.5V; V <sub>NO_</sub> or V <sub>NC_</sub> = 1.0V, 4.5V	+25°C	-0.5	+0.01	+0.5	nA
			T <sub>MIN</sub> to T <sub>MAX</sub>	-1		+1	
COM <sub>_</sub> On-Leakage Current (Note 7)	I <sub>COM_(ON)</sub>	V+ = 5.5V, V <sub>COM_</sub> = 1.0V, 4.5V; V <sub>NO_</sub> or V <sub>NC_</sub> = 1.0V, 4.5V, or floating	+25°C	-1	+0.01	+1	nA
			T <sub>MIN</sub> to T <sub>MAX</sub>	-2		+2	
<b>DYNAMIC CHARACTERISTICS</b>							
Turn-On Time	t <sub>ON</sub>	V <sub>NO_</sub> , V <sub>NC_</sub> = 3.0V; R <sub>L</sub> = 300Ω, C <sub>L</sub> = 35pF, Figure 1	+25°C	30	80		ns
			T <sub>MIN</sub> to T <sub>MAX</sub>			100	
Turn-Off Time	t <sub>OFF</sub>	V <sub>NO_</sub> , V <sub>NC_</sub> = 3.0V; R <sub>L</sub> = 300Ω, C <sub>L</sub> = 35pF, Figure 1	+25°C	20	40		ns
			T <sub>MIN</sub> to T <sub>MAX</sub>			50	
Break-Before-Make Time Delay (Note 7)	t <sub>BBM</sub>	V <sub>NO_</sub> , V <sub>NC_</sub> = 3.0V; R <sub>L</sub> = 300Ω, C <sub>L</sub> = 35pF, Figure 2	+25°C	8			ns
			T <sub>MIN</sub> to T <sub>MAX</sub>	1			
Skew (Note 7)	t <sub>SKEW</sub>	R <sub>S</sub> = 39Ω, C <sub>L</sub> = 50pF, Figure 3	T <sub>MIN</sub> to T <sub>MAX</sub>	0.15	2		ns
<b>DIGITAL I/O</b>							
Input Logic High Voltage	V <sub>IH</sub>		T <sub>MIN</sub> to T <sub>MAX</sub>	2.0			V
Input Logic Low Voltage	V <sub>IL</sub>		T <sub>MIN</sub> to T <sub>MAX</sub>			0.8	V
Input Leakage Current	I <sub>IN</sub>	V+ = 5.5V, V <sub>IN_</sub> = 0V or V+	T <sub>MIN</sub> to T <sub>MAX</sub>	-100		+100	nA

# 4.5Ω/20Ω, 300MHz Bandwidth, Dual SPDT Analog Switches in UCSP

## ELECTRICAL CHARACTERISTICS—Single +5V Supply (continued)

(V+ = +4.2V to +5.5V, VIH = +2.0V, VIL = +0.8V, TA = TMIN to TMAX, unless otherwise noted. Typical values are at V+ = +5.0V, TA = +25°C, unless otherwise noted.) (Notes 2, 3)

PARAMETER	SYMBOL	CONDITIONS	TA	MIN	TYP	MAX	UNITS
<b>POWER SUPPLY</b>							
Power-Supply Range	V+		TMIN to TMAX	1.8		5.5	V
Supply Current	I+	V+ = 5.5V, VIN_ = 0V or V+	TMIN to TMAX			1	μA

- Note 2:** UCSP and TDFN parts are 100% tested at +25°C only, and guaranteed by design over the specified temperature range. μMAX parts are 100% tested at TMAX and guaranteed by design over the specified temperature range.
- Note 3:** The algebraic convention used in this data sheet is where the most negative value is a minimum and the most positive value is a maximum.
- Note 4:** Guaranteed by design for UCSP and TDFN parts.
- Note 5:**  $\Delta R_{ON} = R_{ON(MAX)} - R_{ON(MIN)}$ .
- Note 6:** Flatness is defined as the difference between the maximum and minimum value of on-resistance as measured over the specified analog signal ranges.
- Note 7:** Guaranteed by design.
- Note 8:** Between any two switches.

## Typical Operating Characteristics

(TA = +25°C, unless otherwise noted.)

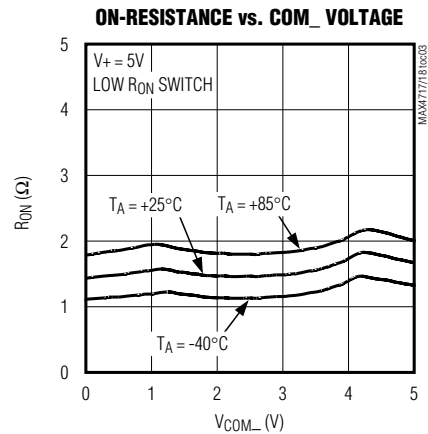
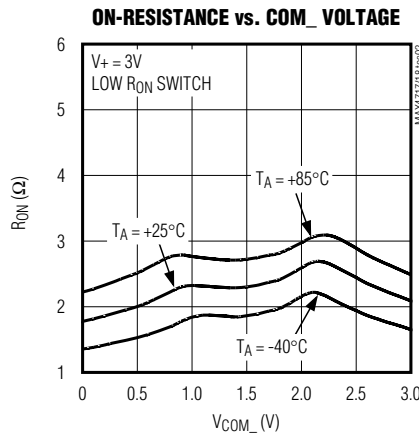
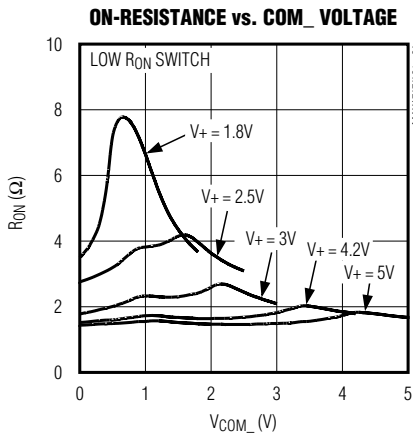

# 4.5Ω/20Ω, 300MHz Bandwidth, Dual SPDT Analog Switches in UCSP

## Typical Operating Characteristics (continued)

( $T_A = +25^\circ\text{C}$ , unless otherwise noted.)

MAX4717/MAX4718

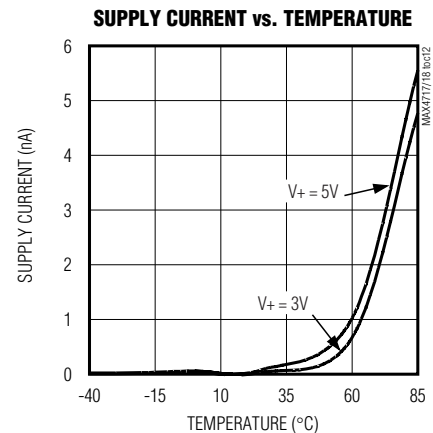
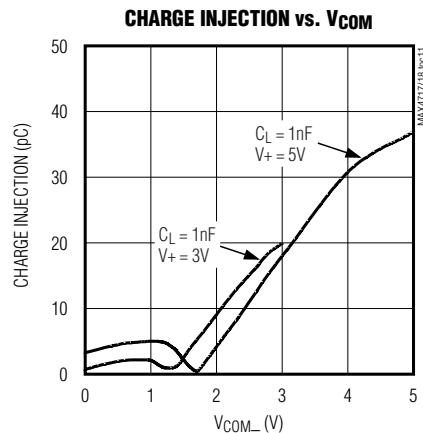
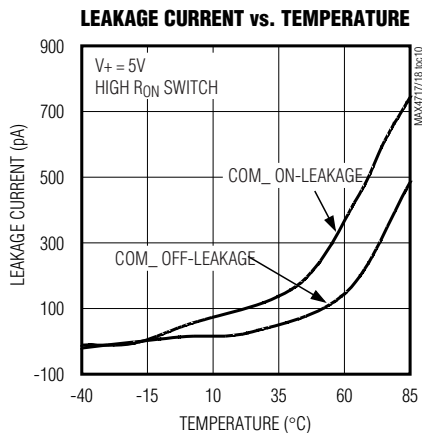
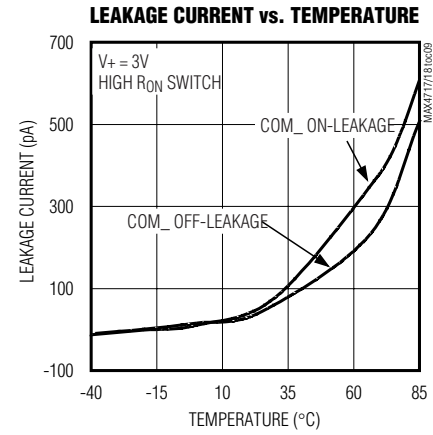
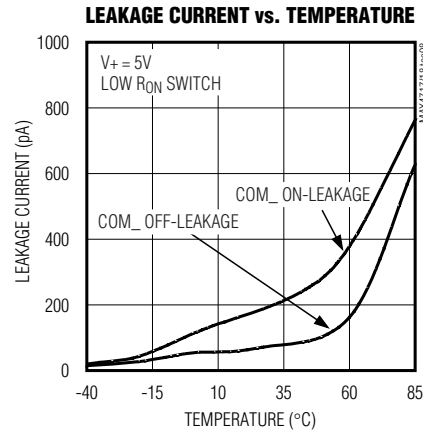
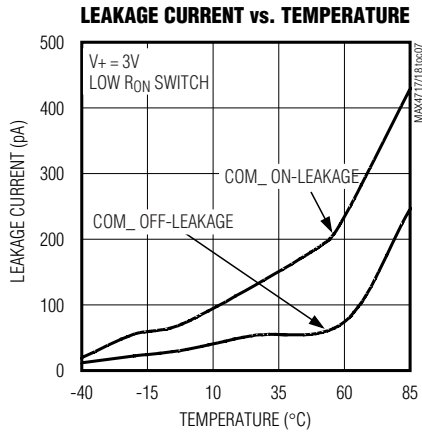
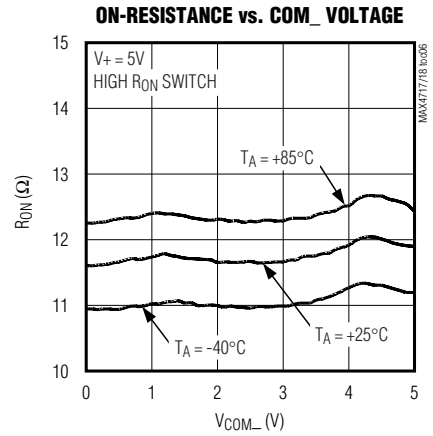
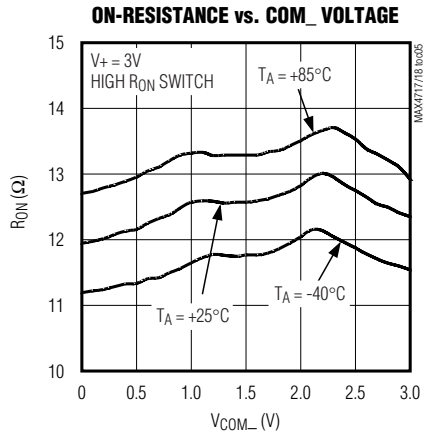
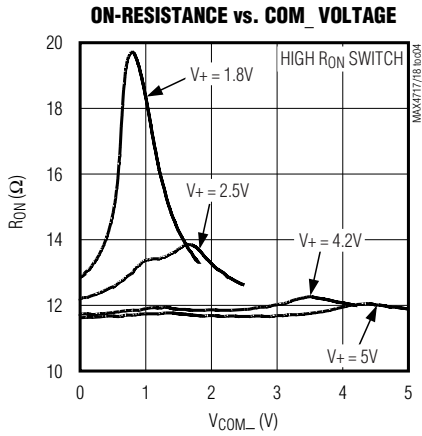

# 4.5Ω/20Ω, 300MHz Bandwidth, Dual SPDT Analog Switches in UCSP

## Typical Operating Characteristics (continued)

(T<sub>A</sub> = +25°C, unless otherwise noted.)

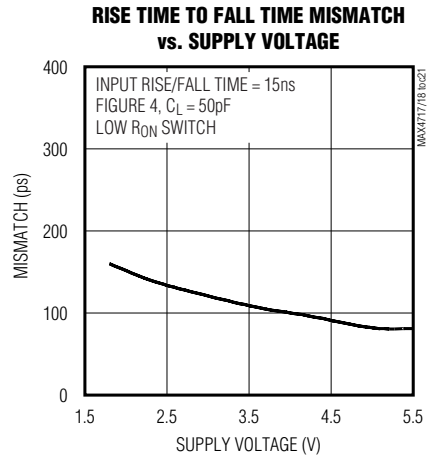
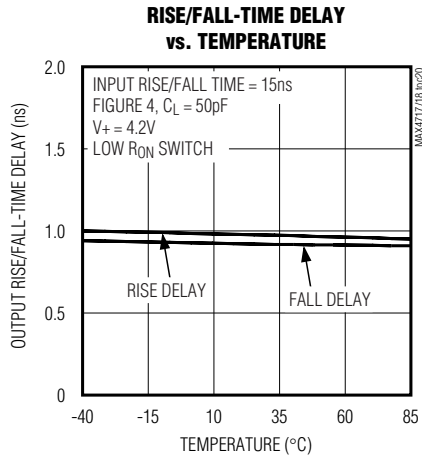
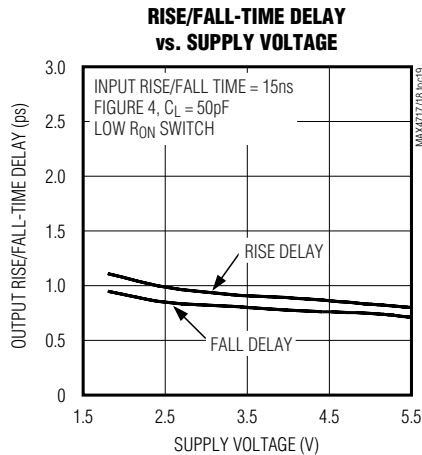
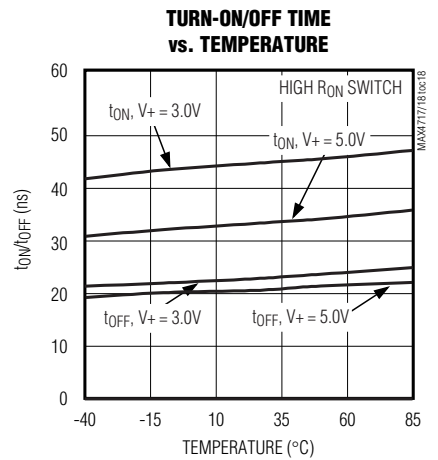
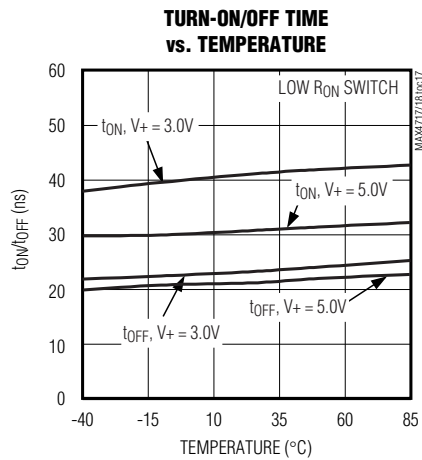
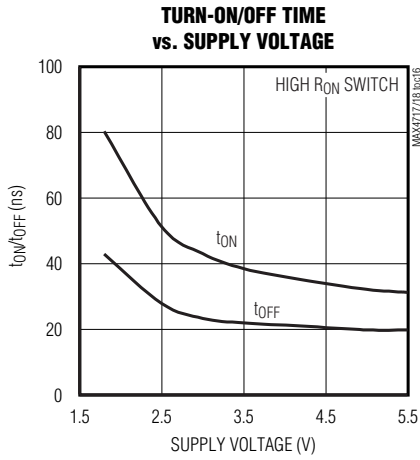
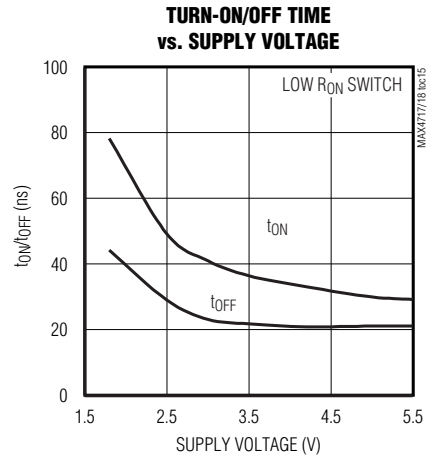
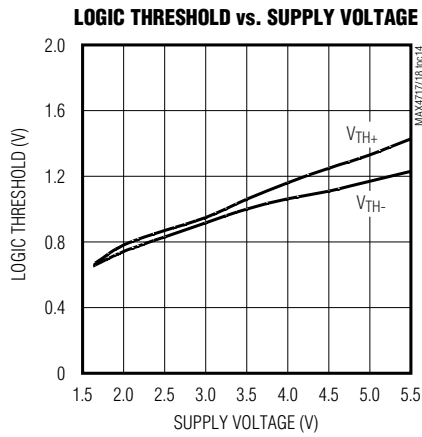
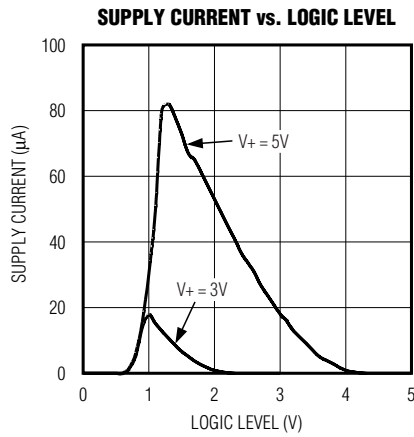



# 4.5Ω/20Ω, 300MHz Bandwidth, Dual SPDT Analog Switches in UCSP

## Typical Operating Characteristics (continued)

MAX4717/MAX4718

(T<sub>A</sub> = +25°C, unless otherwise noted.)

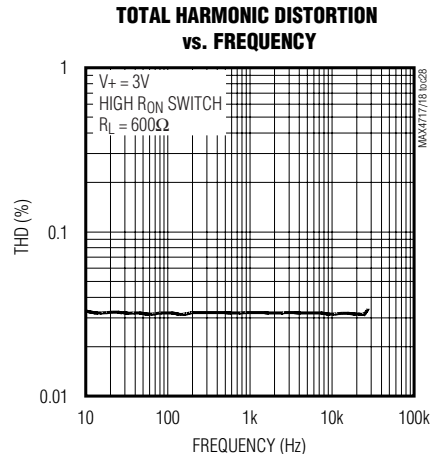
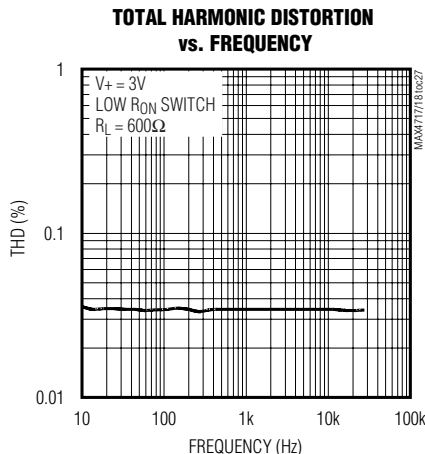
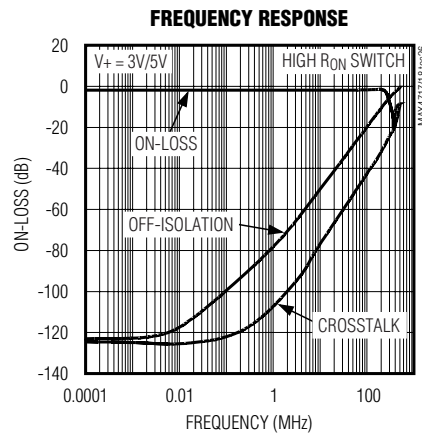
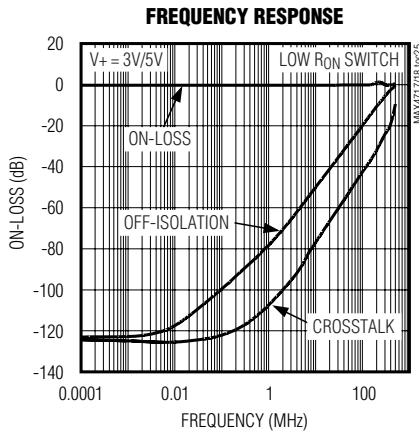
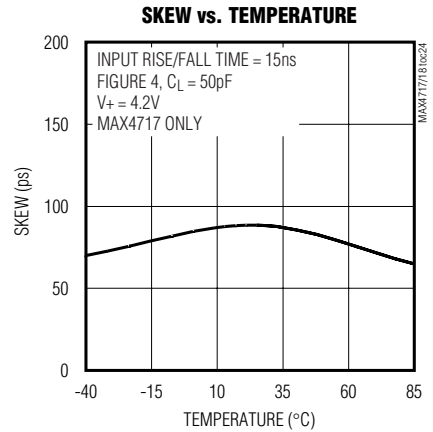
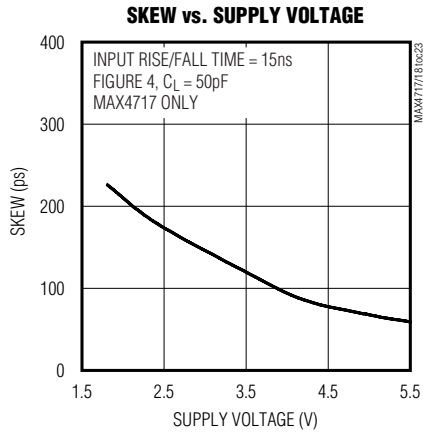
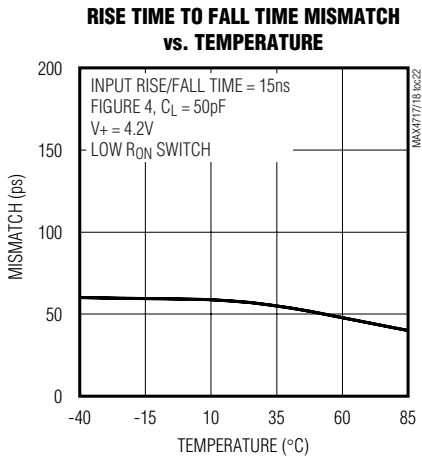

## 4.5Ω/20Ω, 300MHz Bandwidth, Dual SPDT Analog Switches in UCSP

### Pin Description

PIN		NAME	FUNCTION
UCSP	μMAX/TDFN		
A1	7	NC2	Analog Switch 2—Normally Closed Terminal
A2	8	IN2	Analog Switch 2—Digital Control Input
A3	9	COM2	Analog Switch 2—Common Terminal
A4	10	NO2	Analog Switch 2—Normally Open Terminal
B1	6	GND	Ground. Connection.
B4	1	V+	Positive-Supply Voltage
C1	5	NC1	Analog Switch 1—Normally Closed Terminal
C2	4	IN1	Analog Switch 1—Digital Control Input
C3	3	COM1	Analog Switch 1—Common Terminal
C4	2	NO1	Analog Switch 1—Normally Open Terminal
—	—	EP	Exposed Pad (for TDFN package only). Connect to ground.

### Detailed Description

The MAX4717/MAX4718 high-speed, low-voltage, low on-resistance ( $R_{ON}$ ), dual SPDT analog switches operate from a single +1.8V to +5.5V supply. The switches feature break-before-make switching operation and fast switching speeds ( $t_{ON} = 80\text{ns}$  (max),  $t_{OFF} = 40\text{ns}$  (max)).

These switches have low 15pF on-channel capacitance, which allows for 12Mbps switching of the data signals for USB 1.0/1.1 applications. The MAX4717 is designed to switch D+ and D- USB signals with a guaranteed skew of less than 2ns (see Figure 4) as measured from 50% of the input signal to 50% of the output signal.

### Applications Information

#### Digital Control Inputs

The MAX4717/MAX4718 logic inputs accept up to +5.5V regardless of supply voltage. For example, with a +3.3V supply,  $IN_{-}$  can be driven low to GND and high to +5.5V allowing for mixing of logic levels in a system. Driving the control logic inputs rail-to-rail minimizes power consumption. For a +3V supply voltage, the logic thresholds are 0.5V (low) and 1.4V (high); for a +5V supply voltage, the logic thresholds are 0.8V (low) and 2.0V (high).

#### Analog Signal Levels

The on-resistance of the MAX4717/MAX4718 changes very little for analog input signals across the entire supply voltage range (see the *Typical Operating Characteristics*). The switches are bidirectional, so the  $NO_{-}$ ,  $NC_{-}$ , and  $COM_{-}$  pins can be either inputs or outputs.

#### Power-Supply Sequencing and Overvoltage Protection

**Caution: Do not exceed the absolute maximum ratings because stresses beyond the listed ratings may cause permanent damage to the device.**

Proper power-supply sequencing is recommended for all CMOS devices. Always apply  $V_{+}$  before applying analog signals, especially if the analog signal is not current-limited.

### UCSP Application Information

For the latest application details on UCSP construction, dimensions, tape carrier information, printed circuit board techniques, bump-pad layout, and recommended reflow temperature profile as well as the latest information on reliability testing results, go to the Maxim web site at [www.maxim-ic.com/ucsp](http://www.maxim-ic.com/ucsp) to find the Application Note: *USCP—A Wafer-Level Chip-Scale Package*.

### Chip Information

TRANSISTOR COUNT: 235

PROCESS: BiCMOS

# 4.5Ω/20Ω, 300MHz Bandwidth, Dual SPDT Analog Switches in UCSP

## Test Circuits/Timing Diagrams

MAX4717/MAX4718

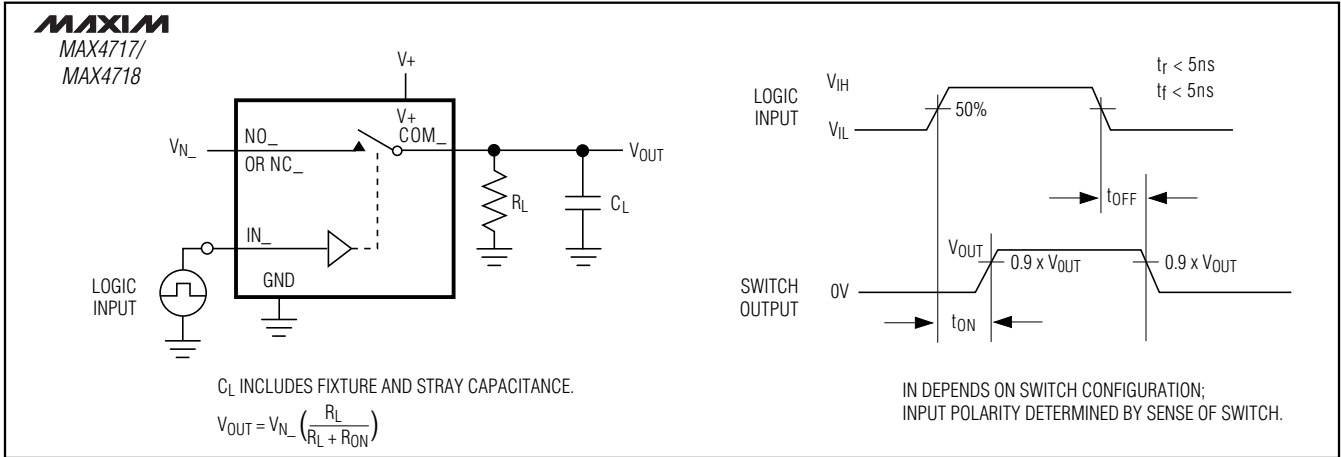

Figure 1. Switching Time

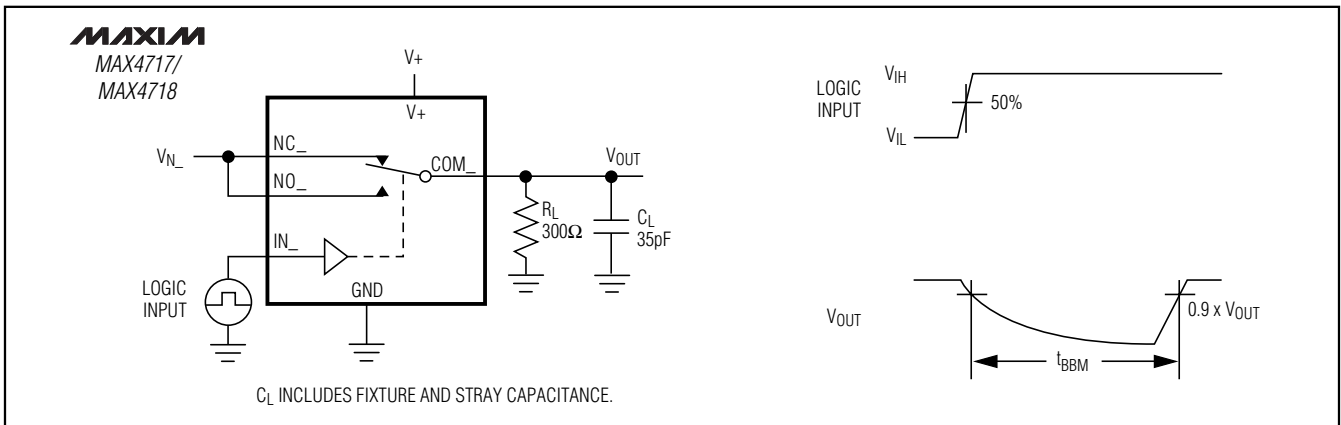

Figure 2. Break-Before-Make Interval

# 4.5Ω/20Ω, 300MHz Bandwidth, Dual SPDT Analog Switches in UCSP

## Test Circuits/Timing Diagrams (continued)

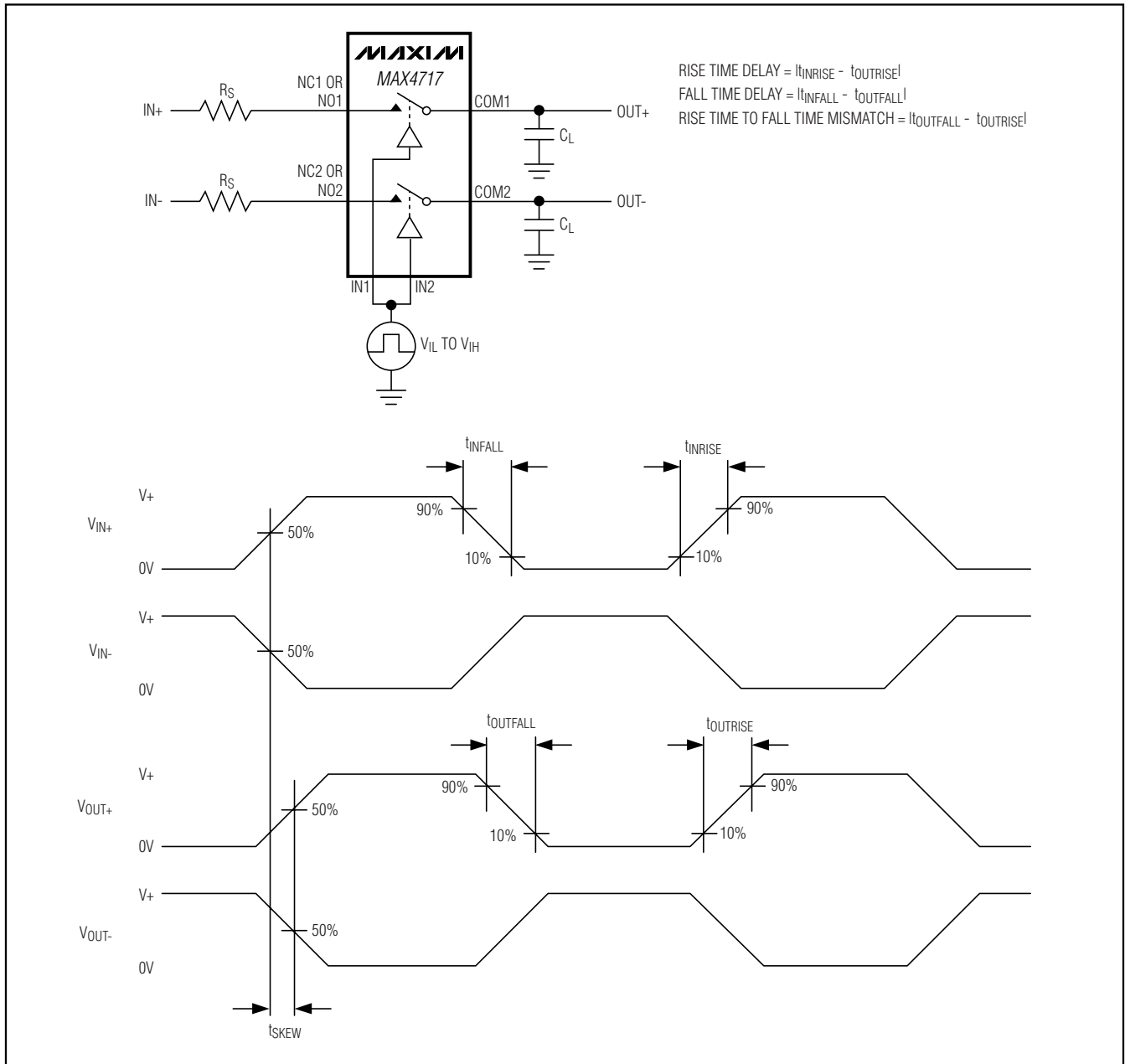

Figure 3. Output Signal Skew

# 4.5Ω/20Ω, 300MHz Bandwidth, Dual SPDT Analog Switches in UCSP

## Test Circuits/Timing Diagrams (continued)

MAX4717/MAX4718

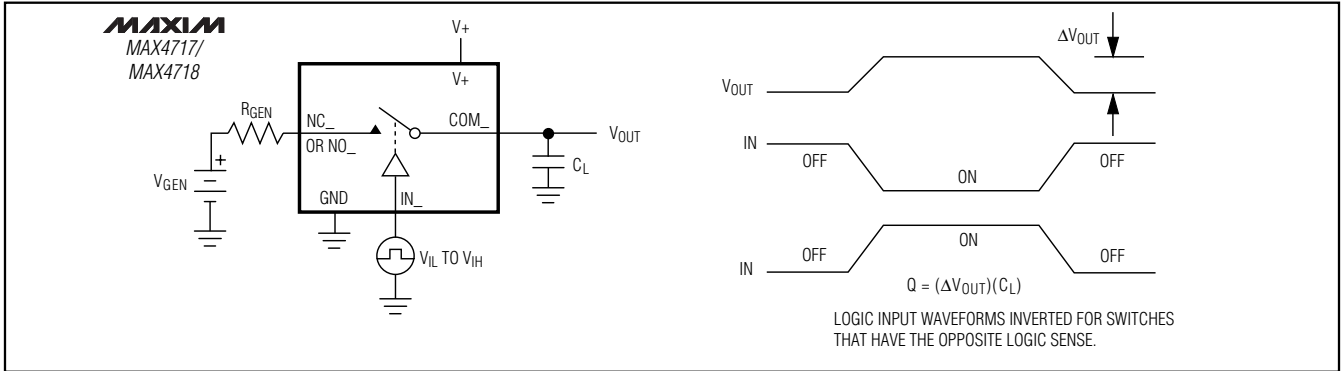

Figure 4. Charge Injection

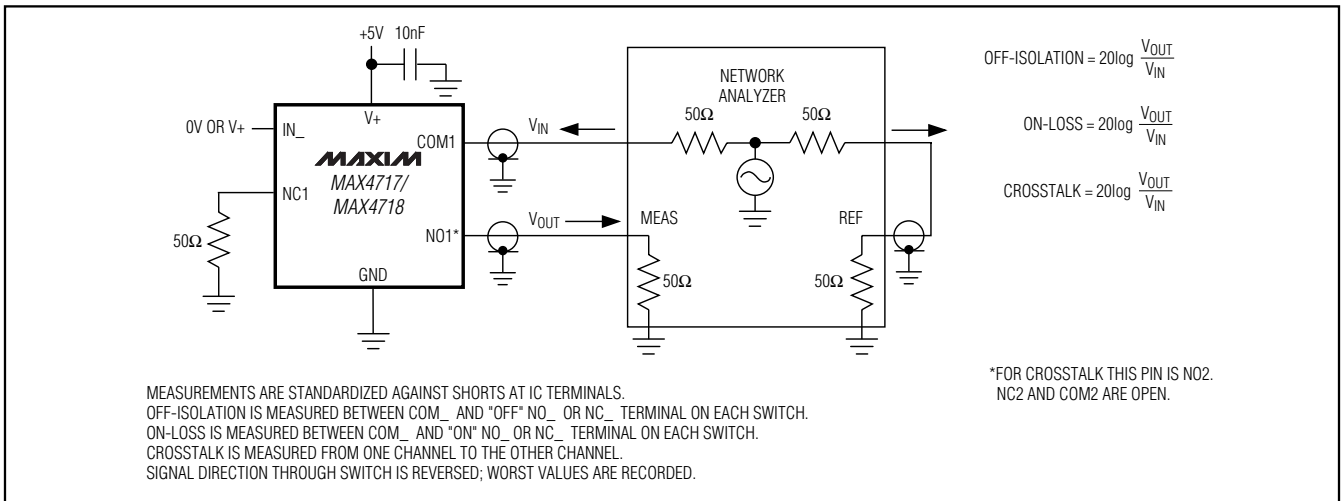

Figure 5. On-Loss, Off-Isolation, and Crosstalk

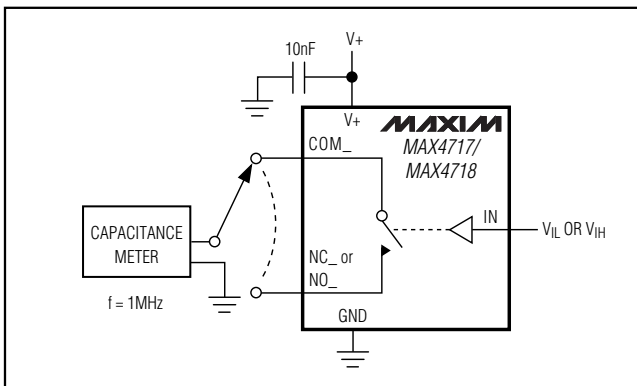

Figure 6. Channel Off/On-Capacitance

# 4.5Ω/20Ω, 300MHz Bandwidth, Dual SPDT Analog Switches in UCSP

## Package Information

(The package drawing(s) in this data sheet may not reflect the most current specifications. For the latest package outline information go to [www.maxim-ic.com/packages](http://www.maxim-ic.com/packages).)

**TOP VIEW**

COMMON DIMENSIONS	
A	0.62±0.05-0.08
A1	0.29±0.02
A2	0.33 REF.
b	∅0.35±0.03
D1	1.00 BASIC
E1	1.50 BASIC
e	0.50 BASIC
SD	0.00 BASIC
SE	0.25 BASIC

PKG. CODE	VARIABLE DIMENSIONS		DEPOPULATED SOLDER BALLS
	D	E	
B12-1	1.54±0.05	2.02±0.05	NONE
B12-2	1.54±0.05	2.02±0.05	B3
B12-3	1.54±0.05	2.12±0.05	NONE
B12-4	1.54±0.05	2.02±0.05	B2, B3
B12-5	1.64±0.05	2.12±0.05	B2
B12-6	1.64±0.05	2.12±0.05	B3
B12-7	1.54±0.05	2.02±0.05	B1, B3
B12-8	1.54±0.05	2.02±0.05	B2
B12-9	1.54±0.05	2.12±0.05	B2, B3
B12-10	1.54±0.05	2.02±0.05	B1, B2, B3, B4
B12-11	1.54±0.05	2.02±0.05	A2, C3

**NOTES:**

- ALL DIMENSIONS ARE IN MILLIMETERS.
- PRODUCT MARKING: NUMBER OF CHARACTERS AND LINES VARY PER PRODUCT.

**SIDE VIEW**

**BOTTOM VIEW**

PROPRIETARY INFORMATION

TITLE:  
PACKAGE OUTLINE, 4x3 UCSP

APPROVAL	DOCUMENT CONTROL NO. 21-0104	REV. F	1/1
----------	---------------------------------	-----------	-----

12L UCSP 4x3.EPS

# 4.5Ω/20Ω, 300MHz Bandwidth, Dual SPDT Analog Switches in UCSP

## Package Information (continued)

(The package drawing(s) in this data sheet may not reflect the most current specifications. For the latest package outline information go to [www.maxim-ic.com/packages](http://www.maxim-ic.com/packages).)

MAX4717/MAX4718

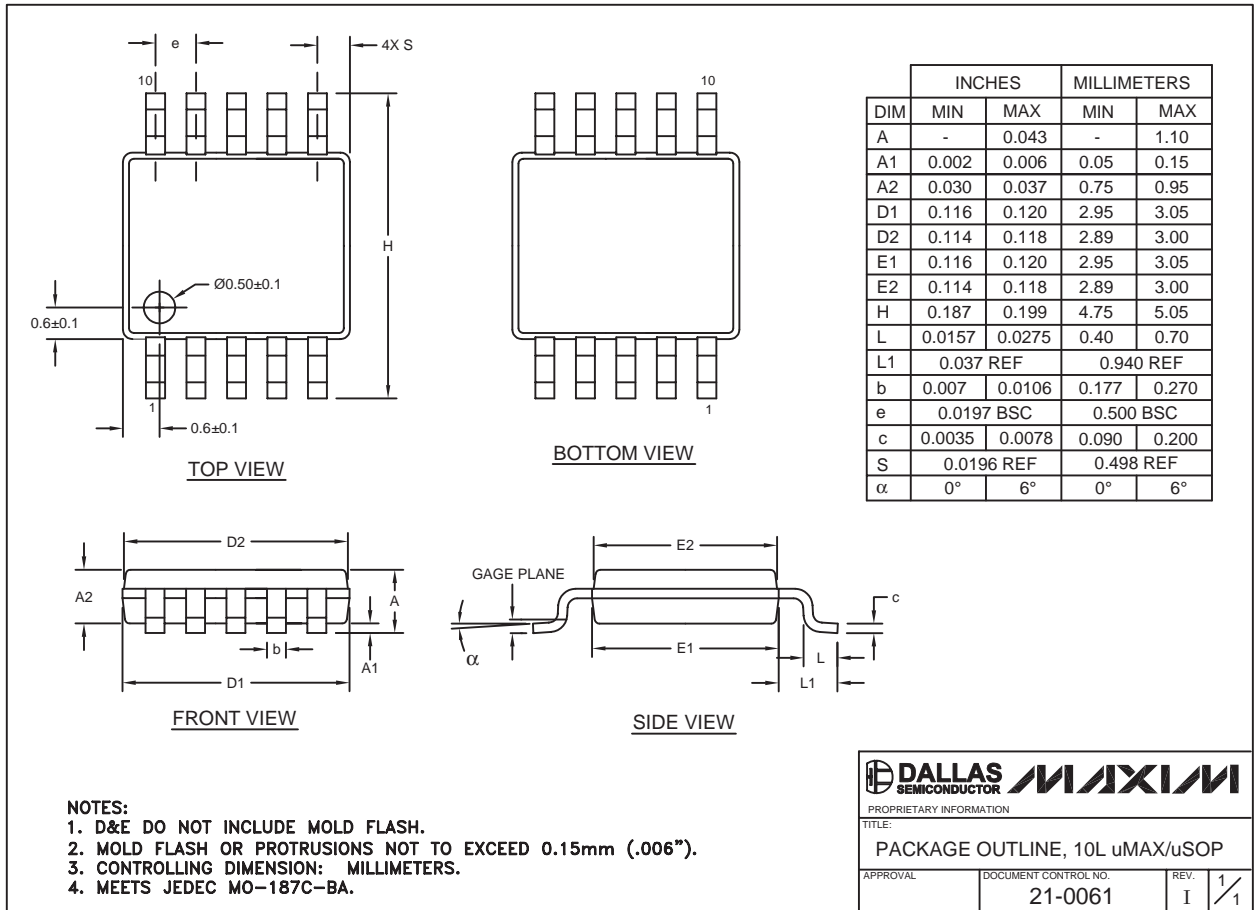

# 4.5Ω/20Ω, 300MHz Bandwidth, Dual SPDT Analog Switches in UCSP

## Package Information (continued)

(The package drawing(s) in this data sheet may not reflect the most current specifications. For the latest package outline information go to [www.maxim-ic.com/packages](http://www.maxim-ic.com/packages).)

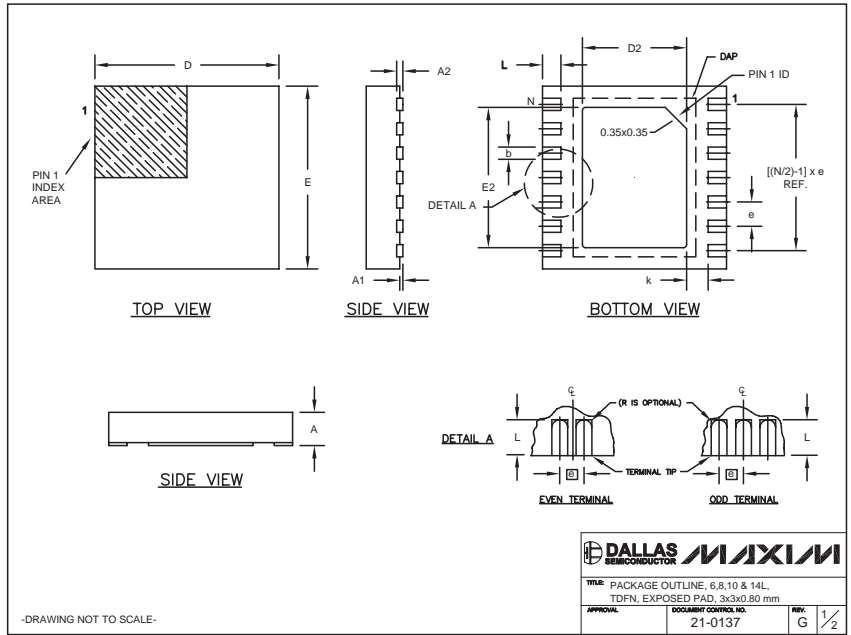

COMMON DIMENSIONS							
SYMBOL	MIN.	MAX.					
A	0.70	0.80					
D	2.90	3.10					
E	2.90	3.10					
A1	0.00	0.05					
L	0.20	0.40					
k	0.25 MIN.						
A2	0.20 REF.						

PACKAGE VARIATIONS								
PKG. CODE	N	D2	E2	e	JEDEC SPEC	b	[(N/2)-1] x e	DOWNBONDS ALLOWED
T633-1	6	1.50±0.10	2.30±0.10	0.95 BSC	MO229 / WEEA	0.40±0.05	1.90 REF	NO
T633-2	6	1.50±0.10	2.30±0.10	0.95 BSC	MO229 / WEEA	0.40±0.05	1.90 REF	NO
T833-1	8	1.50±0.10	2.30±0.10	0.65 BSC	MO229 / WEEC	0.30±0.05	1.95 REF	NO
T833-2	8	1.50±0.10	2.30±0.10	0.65 BSC	MO229 / WEEC	0.30±0.05	1.95 REF	NO
T833-3	8	1.50±0.10	2.30±0.10	0.65 BSC	MO229 / WEEC	0.30±0.05	1.95 REF	YES
T1033-1	10	1.50±0.10	2.30±0.10	0.50 BSC	MO229 / WEED-3	0.25±0.05	2.00 REF	NO
T1433-1	14	1.70±0.10	2.30±0.10	0.40 BSC	----	0.20±0.05	2.40 REF	YES
T1433-2	14	1.70±0.10	2.30±0.10	0.40 BSC	----	0.20±0.05	2.40 REF	NO

NOTES:  
 1. ALL DIMENSIONS ARE IN mm, ANGLES IN DEGREES.  
 2. COPLANARITY SHALL NOT EXCEED 0.08 mm.  
 3. WARPAGE SHALL NOT EXCEED 0.10 mm.  
 4. PACKAGE LENGTH/PACKAGE WIDTH ARE CONSIDERED AS SPECIAL CHARACTERISTIC(S).  
 5. DRAWING CONFORMS TO JEDEC MO229, EXCEPT DIMENSIONS "D2" AND "E2", AND T1433-1 & T1433-2.  
 6. "N" IS THE TOTAL NUMBER OF LEADS.  
 7. NUMBER OF LEADS SHOWN ARE FOR REFERENCE ONLY.

TITLE: PACKAGE OUTLINE, 6,8,10 & 14L, DFN, EXPOSED PAD, 3x3x0,80 mm  
 APPROVAL: DOCUMENT CONTROL NO. 21-0137 REV: G 1/2

-DRAWING NOT TO SCALE-

Maxim cannot assume responsibility for use of any circuitry other than circuitry entirely embodied in a Maxim product. No circuit patent licenses are implied. Maxim reserves the right to change the circuitry and specifications without notice at any time.

16 **Maxim Integrated Products, 120 San Gabriel Drive, Sunnyvale, CA 94086 408-737-7600**





## Стандарт Электрон Связь

Мы молодая и активно развивающаяся компания в области поставок электронных компонентов. Мы поставляем электронные компоненты отечественного и импортного производства напрямую от производителей и с крупнейших складов мира.

Благодаря сотрудничеству с мировыми поставщиками мы осуществляем комплексные и плановые поставки широчайшего спектра электронных компонентов.

Собственная эффективная логистика и склад в обеспечивает надежную поставку продукции в точно указанные сроки по всей России.

Мы осуществляем техническую поддержку нашим клиентам и предпродажную проверку качества продукции. На все поставляемые продукты мы предоставляем гарантию .

Осуществляем поставки продукции под контролем ВП МО РФ на предприятия военно-промышленного комплекса России , а также работаем в рамках 275 ФЗ с открытием отдельных счетов в уполномоченном банке. Система менеджмента качества компании соответствует требованиям ГОСТ ISO 9001.

Минимальные сроки поставки, гибкие цены, неограниченный ассортимент и индивидуальный подход к клиентам являются основой для выстраивания долгосрочного и эффективного сотрудничества с предприятиями радиоэлектронной промышленности, предприятиями ВПК и научно-исследовательскими институтами России.

С нами вы становитесь еще успешнее!

### Наши контакты:

**Телефон:** +7 812 627 14 35

**Электронная почта:** [sales@st-electron.ru](mailto:sales@st-electron.ru)

**Адрес:** 198099, Санкт-Петербург,  
Промышленная ул, дом № 19, литера Н,  
помещение 100-Н Офис 331