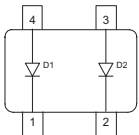

**Silicon Switching Diode**

- For high-speed switching applications
- Electrical insulated diodes
- Pb-free (RoHS compliant) package <sup>1)</sup>
- Qualified according AEC Q101

**BAS28/W**

Type	Package	Configuration	Marking
BAS28	SOT143	parallel pair	JTs
BAS28W	SOT343	parallel pair	JTs

**Maximum Ratings** at  $T_A = 25^\circ\text{C}$ , unless otherwise specified

Parameter	Symbol	Value	Unit
Diode reverse voltage	$V_R$	80	V
Peak reverse voltage	$V_{RM}$	85	
Forward current	$I_F$	200	mA
Peak forward current	$I_{FM}$	-	
Surge forward current, $t = 1 \mu\text{s}$	$I_{FS}$	4.5	A
Non-repetitive peak surge forward current	$I_{FSM}$	-	
Total power dissipation	$P_{tot}$		mW
BAS28, $T_S \leq 31^\circ\text{C}$		330	
BAS28W, $T_S \leq 103^\circ\text{C}$		250	
Junction temperature	$T_j$	150	$^\circ\text{C}$
Storage temperature	$T_{stg}$	-55 ... 150	

<sup>1</sup>Pb-containing package may be available upon special request

**Thermal Resistance**

Parameter	Symbol	Value	Unit
Junction - soldering point <sup>1)</sup>	$R_{thJS}$		K/W
BAS28		≤ 360	
BAS28W		≤ 190	

**Electrical Characteristics at  $T_A = 25^\circ\text{C}$ , unless otherwise specified**

Parameter	Symbol	Values			Unit
		min.	typ.	max.	

**DC Characteristics**

Breakdown voltage $I_{(BR)} = 100 \mu\text{A}$	$V_{(BR)}$	85	-	-	V
Reverse current $V_R = 75 \text{ V}$ $V_R = 25 \text{ V}, T_A = 150^\circ\text{C}$ $V_R = 75 \text{ V}, T_A = 150^\circ\text{C}$	$I_R$	-	-	0.1 30 50	$\mu\text{A}$
Forward voltage $I_F = 1 \text{ mA}$ $I_F = 10 \text{ mA}$ $I_F = 50 \text{ mA}$ $I_F = 100 \text{ mA}$ $I_F = 150 \text{ mA}$	$V_F$	-	-	715 855 1000 1200 1250	mV

**AC Characteristics**

Diode capacitance $V_R = 0 \text{ V}, f = 1 \text{ MHz}$	$C_T$	-	-	2	pF
Reverse recovery time $I_F = 10 \text{ mA}, I_R = 10 \text{ mA}$ , measured at $I_R = 1 \text{ mA}$ , $R_L = 100 \Omega$	$t_{rr}$	-	-	4	ns

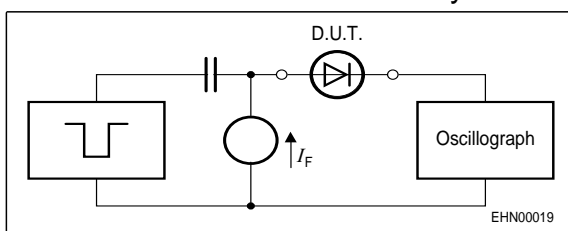
**Test circuit for reverse recovery time**

Pulse generator:  $t_p = 100\text{ns}$ ,  $D = 0.05$ ,  
 $t_f = 0.6\text{ns}$ ,  $R_i = 50\Omega$

Oscilloscope:  $R = 50\Omega$ ,  $t_f = 0.35\text{ns}$ ,  
 $C \leq 1\text{pF}$

<sup>1)</sup>For calculation of  $R_{thJA}$  please refer to Application Note Thermal Resistance

**Reverse current  $I_R = f(T_A)$**

$V_R = \text{Parameter}$

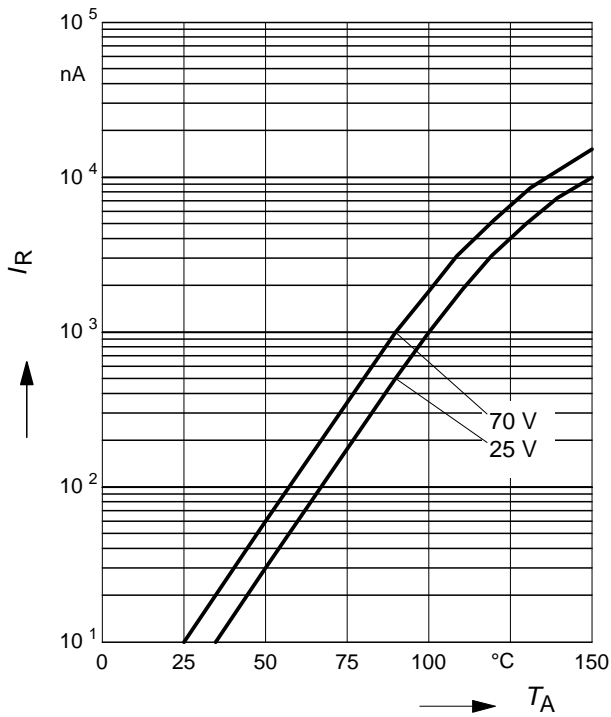

**Forward Voltage  $V_F = f(T_A)$**

$I_F = \text{Parameter}$

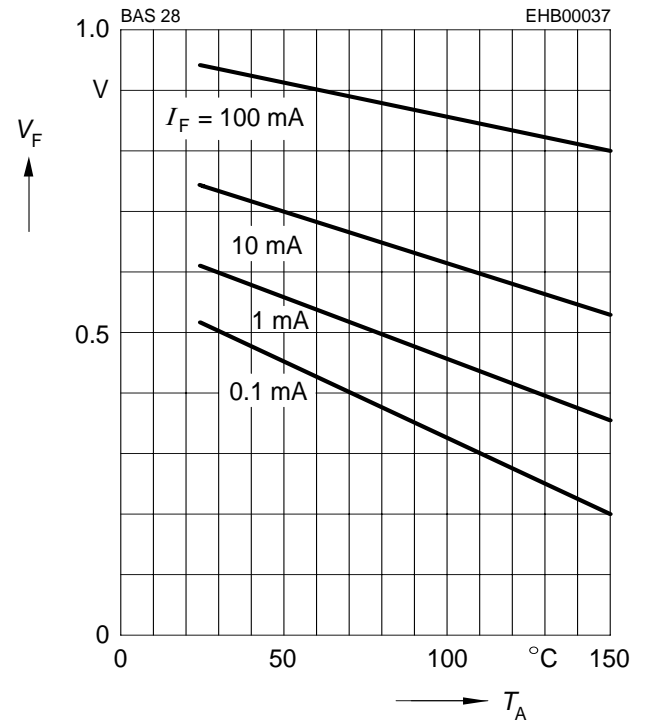

**Forward current  $I_F = f(V_F)$**

$T_A = 25\text{ °C}$

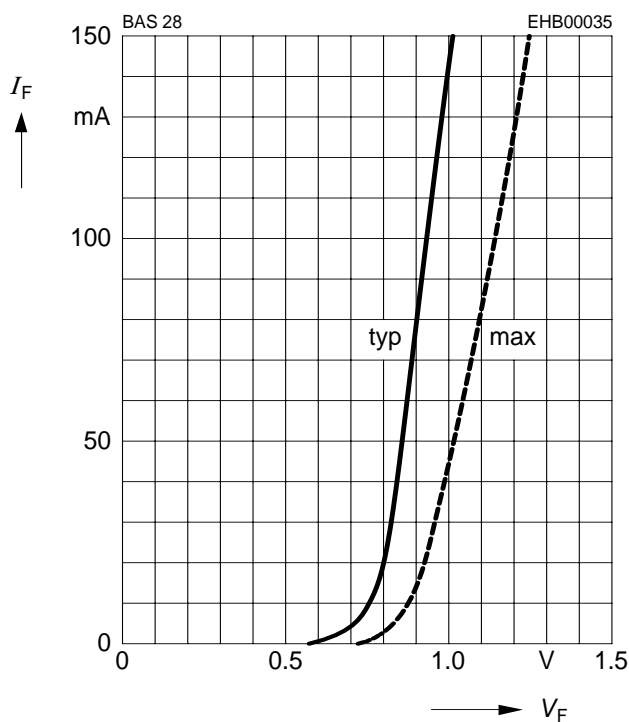

**Peak forward current  $I_{FM} = f(t_p)$**

$T_A = 25\text{ °C}$

BAS28

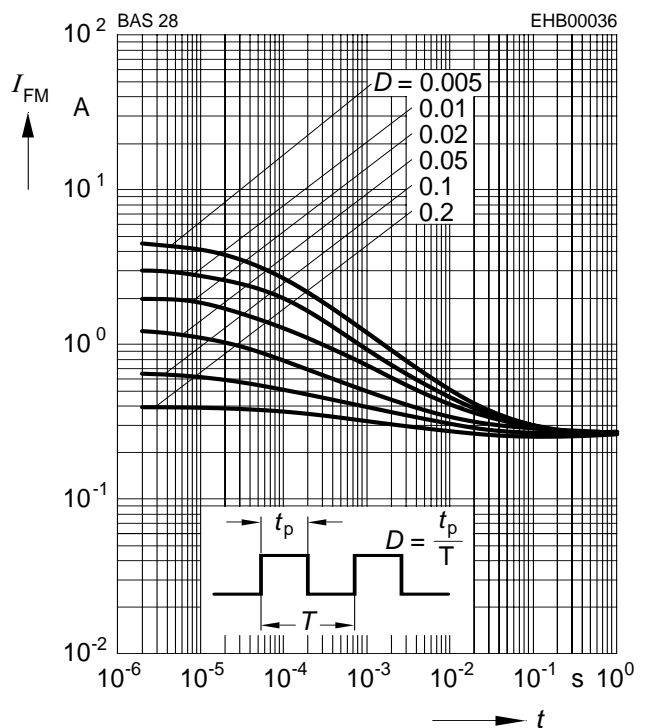

**Forward current  $I_F = f(T_S)$**

BAS28

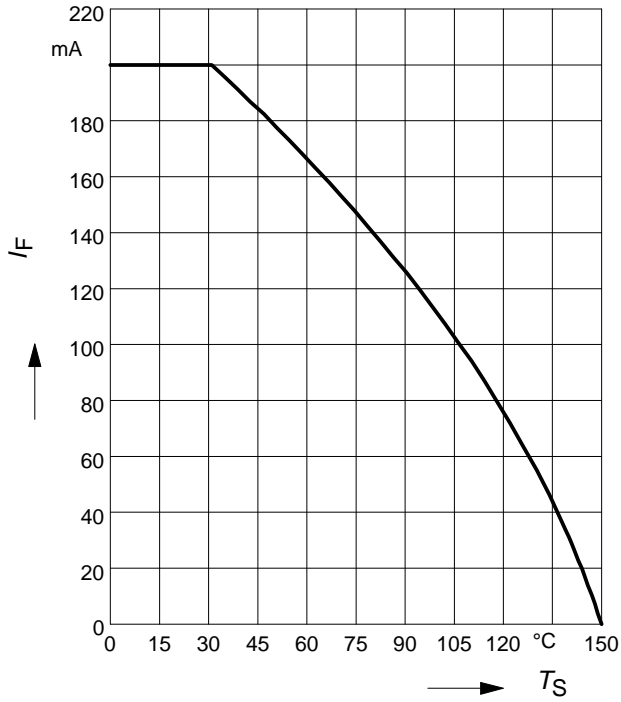

**Forward current  $I_F = f(T_S)$**

BAS28W

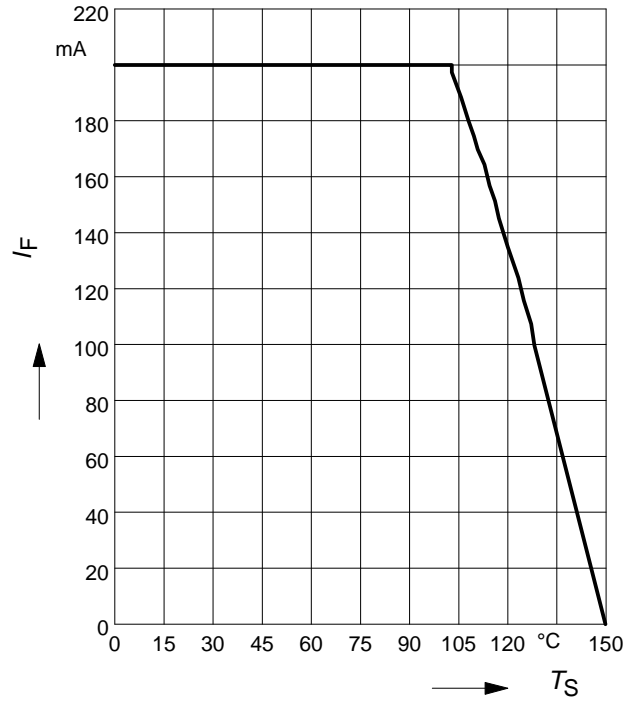

**Permissible Puls Load  $R_{thJS} = f(t_p)$**

BAS28W

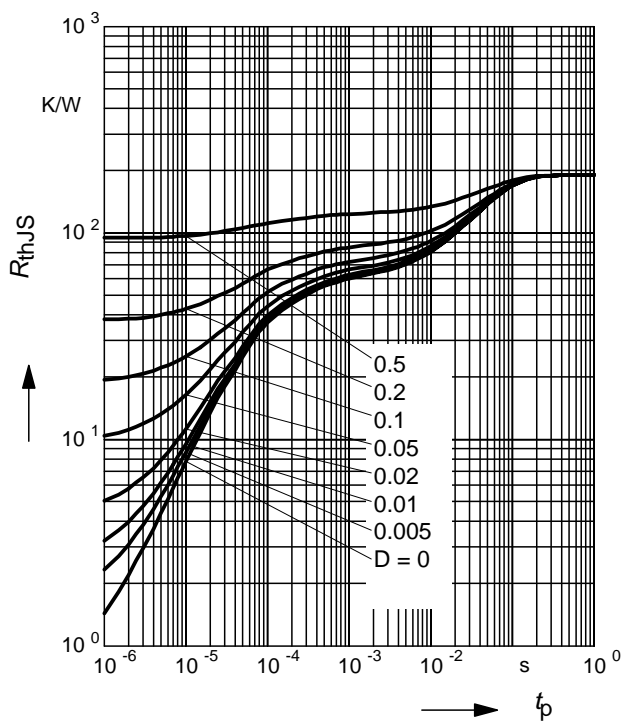

**Permissible Pulse Load**

$I_{Fmax} / I_{FDC} = f(t_p)$  BAS28W

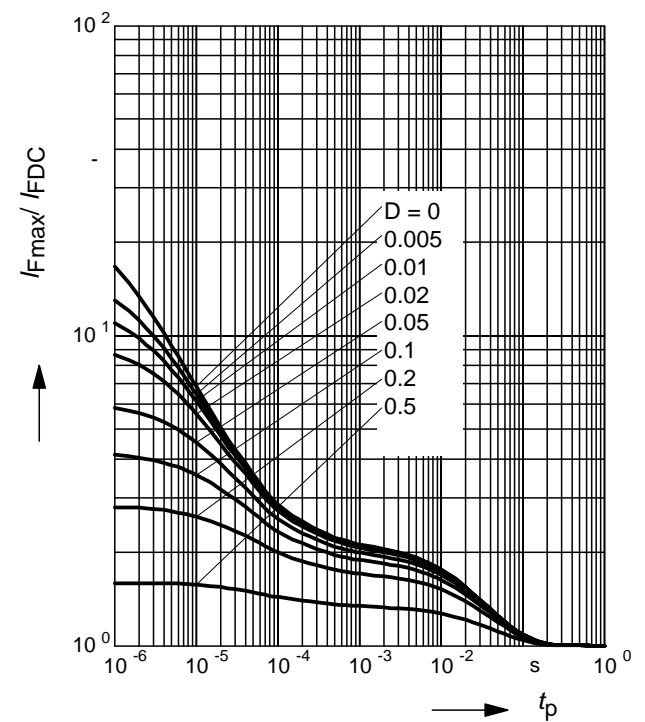

Package Outline

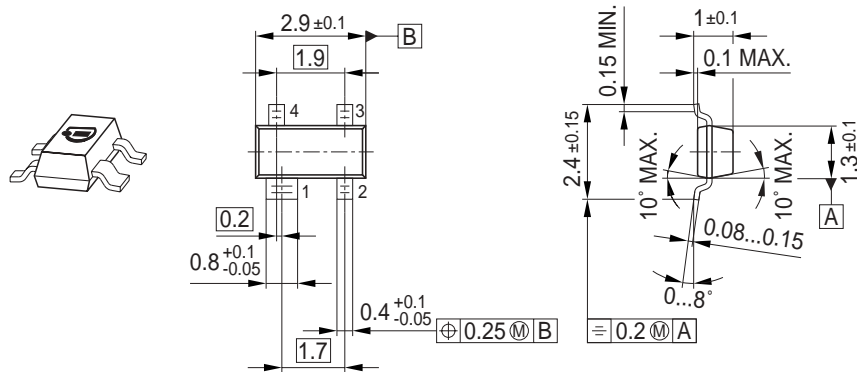

Foot Print

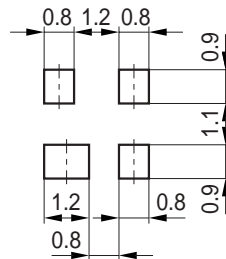

Marking Layout (Example)

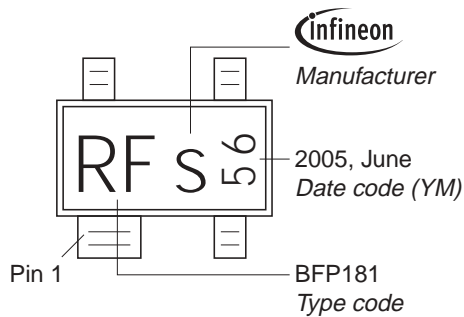

Standard Packing

Reel  $\varnothing 180 \text{ mm}$  = 3.000 Pieces/Reel  
 Reel  $\varnothing 330 \text{ mm}$  = 10.000 Pieces/Reel

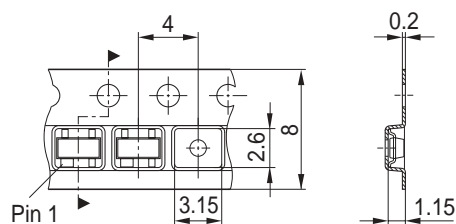

Package Outline

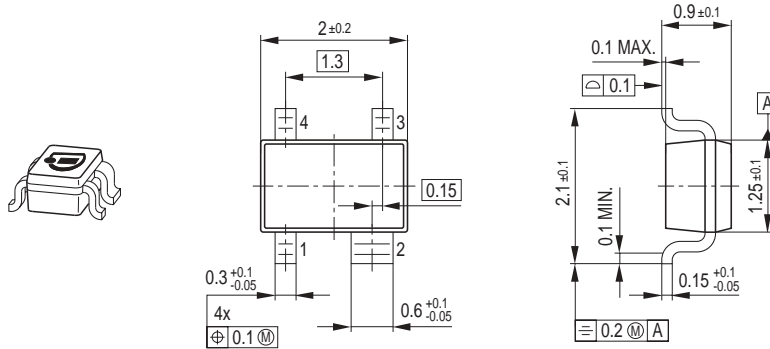

Foot Print

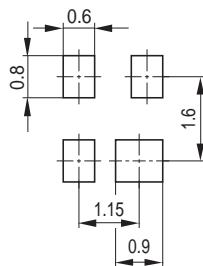

Marking Layout (Example)

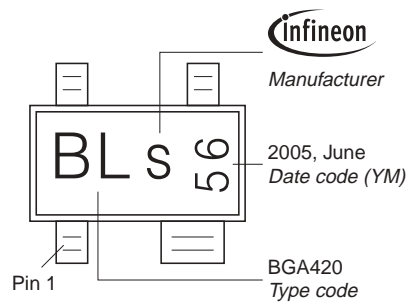

Standard Packing

Reel ø180 mm = 3.000 Pieces/Reel  
 Reel ø330 mm = 10.000 Pieces/Reel

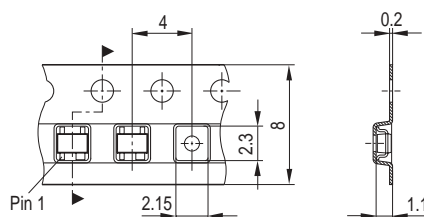

Edition 2006-02-01

Published by

Infineon Technologies AG

81726 München, Germany

© Infineon Technologies AG 2007.

All Rights Reserved.

### **Attention please!**

The information given in this dokument shall in no event be regarded as a guarantee of conditions or characteristics ("Beschaffenheitsgarantie"). With respect to any examples or hints given herein, any typical values stated herein and/or any information regarding the application of the device, Infineon Technologies hereby disclaims any and all warranties and liabilities of any kind, including without limitation warranties of non-infringement of intellectual property rights of any third party.

### **Information**

For further information on technology, delivery terms and conditions and prices please contact your nearest Infineon Technologies Office ([www.infineon.com](http://www.infineon.com)).

### **Warnings**

Due to technical requirements components may contain dangerous substances. For information on the types in question please contact your nearest Infineon Technologies Office.

Infineon Technologies Components may only be used in life-support devices or systems with the express written approval of Infineon Technologies, if a failure of such components can reasonably be expected to cause the failure of that life-support device or system, or to affect the safety or effectiveness of that device or system.

Life support devices or systems are intended to be implanted in the human body, or to support and/or maintain and sustain and/or protect human life. If they fail, it is reasonable to assume that the health of the user or other persons may be endangered.



## Стандарт Электрон Связь

Мы молодая и активно развивающаяся компания в области поставок электронных компонентов. Мы поставляем электронные компоненты отечественного и импортного производства напрямую от производителей и с крупнейших складов мира.

Благодаря сотрудничеству с мировыми поставщиками мы осуществляем комплексные и плановые поставки широчайшего спектра электронных компонентов.

Собственная эффективная логистика и склад в обеспечивает надежную поставку продукции в точно указанные сроки по всей России.

Мы осуществляем техническую поддержку нашим клиентам и предпродажную проверку качества продукции. На все поставляемые продукты мы предоставляем гарантию .

Осуществляем поставки продукции под контролем ВП МО РФ на предприятия военно-промышленного комплекса России , а также работаем в рамках 275 ФЗ с открытием отдельных счетов в уполномоченном банке. Система менеджмента качества компании соответствует требованиям ГОСТ ISO 9001.

Минимальные сроки поставки, гибкие цены, неограниченный ассортимент и индивидуальный подход к клиентам являются основой для выстраивания долгосрочного и эффективного сотрудничества с предприятиями радиоэлектронной промышленности, предприятиями ВПК и научно-исследовательскими институтами России.

С нами вы становитесь еще успешнее!

### Наши контакты:

**Телефон:** +7 812 627 14 35

**Электронная почта:** [sales@st-electron.ru](mailto:sales@st-electron.ru)

**Адрес:** 198099, Санкт-Петербург,  
Промышленная ул, дом № 19, литера Н,  
помещение 100-Н Офис 331