

True Low Power Platform (as low as 66  $\mu$ A/MHz, and 0.57  $\mu$ A for RTC + LVD), 1.6 V to 5.5 V operation, 32/64 Kbyte Flash, Max.32 MHz CPU operation, Enhanced analog functions, for General Purpose Applications

## 1. OUTLINE

### 1.1 Features

#### Ultra-low power consumption technology

- $V_{DD}$  = single power supply voltage of 1.6 to 5.5 V which can operate a 1.8 V device at a low voltage
- HALT mode
- STOP mode
- SNOOZE mode

#### RL78 CPU core

- CISC architecture with 3-stage pipeline
- Minimum instruction execution time: Can be changed from high speed (0.03125  $\mu$ s: @ 32 MHz operation with high-speed on-chip oscillator) to ultra-low speed (30.5  $\mu$ s: @ 32.768 kHz operation with subsystem clock)
- Multiply/divide/multiply & accumulate instructions are supported.
- Address space: 1 MB
- General-purpose registers: (8-bit register  $\times$  8)  $\times$  4 banks
- On-chip RAM: 5.5 KB

#### Code flash memory

- Code flash memory: 32/64 KB
- Block size: 1 KB
- Prohibition of block erase and rewriting (security function)
- On-chip debug function
- Self-programming (with boot swap function/flash shield window function)

#### Data flash memory

- Data flash memory: 4 KB
- Back ground operation (BGO): Instructions can be executed from the program memory while rewriting the data flash memory.
- Number of rewrites: 1,000,000 times (TYP.)
- Voltage of rewrites:  $V_{DD}$  = 1.8 to 5.5 V

#### High-speed on-chip oscillator

- Select from 64 MHz, 48 MHz, 32 MHz, 24 MHz, 16 MHz, 12 MHz, 8 MHz, 6 MHz, 4 MHz, 3 MHz, 2 MHz, and 1 MHz
- High accuracy:  $\pm 1.0\%$  ( $V_{DD}$  = 1.8 to 5.5 V,  $T_A$  = -20 to +85°C)

#### Operating ambient temperature

- $T_A$  = -40 to +85°C (A: Consumer applications)
- $T_A$  = -40 to +105°C (G: Industrial applications)

#### Power management and reset function

- On-chip power-on-reset (POR) circuit
- On-chip voltage detector (LVD) (Select interrupt and reset from 14 levels)

#### Data transfer controller (DTC)

- Transfer modes: Normal transfer mode, repeat transfer mode, block transfer mode
- Activation sources: Activated by interrupt sources.
- Chain transfer function

#### Event link controller (ELC)

- Event signals of 22 types can be linked to the specified peripheral function.

#### Serial interfaces

- CSI: 3 to 6 channels
- UART/UART (LIN-bus supported): 3 channels
- I<sup>2</sup>C/simplified I<sup>2</sup>C: 3 to 6 channels
- IrDA: 1 channel

#### Timer

- 16-bit timer: 9 channels  
(Timer Array Unit (TAU): 4 channels, Timer RJ: 1 channel, Timer RD: 2 channels (with PWMOPA), Timer RG: 1 channel, Timer RX: 1 channel)
- 12-bit interval timer: 1 channel
- Real-time clock: 1 channel (calendar for 99 years, alarm function, and clock correction function)
- Watchdog timer: 1 channel (operable with the dedicated low-speed on-chip oscillator)

#### A/D converter

- 8/10-bit resolution A/D converter ( $V_{DD}$  = 1.6 to 5.5 V)
- Analog input: 8 to 17 channels
- Internal reference voltage (1.45 V) and temperature sensor

#### D/A converter

- 8-bit resolution D/A converter ( $V_{DD}$  = 1.6 to 5.5 V)
- Analog output: 1 or 2 channels
- Output voltage: 0 V to  $V_{DD}$
- Real-time output function

#### Comparator

- 2 channels (pin selector is provided for 1 channel)
- Incorporates a function for the output of a timer window in combination with the timer array unit.
- The external reference voltage or internal reference voltage can be selected as the reference voltage.

#### Programmable gain amplifier (PGA)

- 1 channel

#### I/O port

- I/O port: 20 to 58 (N-ch open drain I/O [withstand voltage of 6 V]: 2 to 4, N-ch open drain I/O [VDD withstand voltage/EVDD withstand voltage]: 10 to 16)
- Can be set to N-ch open drain, TTL input buffer, and on-chip pull-up resistor
- Different potential interface: Can connect to a 1.8/2.5/3 V device
- On-chip key interrupt function
- On-chip clock output/buzzer output controller

#### Others

- On-chip BCD (binary-coded decimal) correction circuit

**Remark** The functions mounted depend on the product. See **1.6 Outline of Functions**.

## ○ ROM, RAM capacities

Flash ROM	Data flash	RAM	RL78/G1F				
			24 pins	32 pins	36 pins	48 pins	64 pins
64 KB	4 KB	5.5 KB <small>Note</small>	R5F11B7E	R5F11BBE	R5F11BCE	R5F11BGE	R5F11BLE
32 KB	4 KB	5.5 KB <small>Note</small>	R5F11B7C	R5F11BBC	R5F11BCC	R5F11BGC	R5F11BLC

**Note** This is about 4.5 KB when performing self-programming and rewriting the data flash memory (For details, see **CHAPTER 3 CPU ARCHITECTURE** in the RL78/G1F User's Manual).

## 1.2 Ordering Information

Figure 1 - 1 Part Number, Memory Size, and Package of RL78/G1F

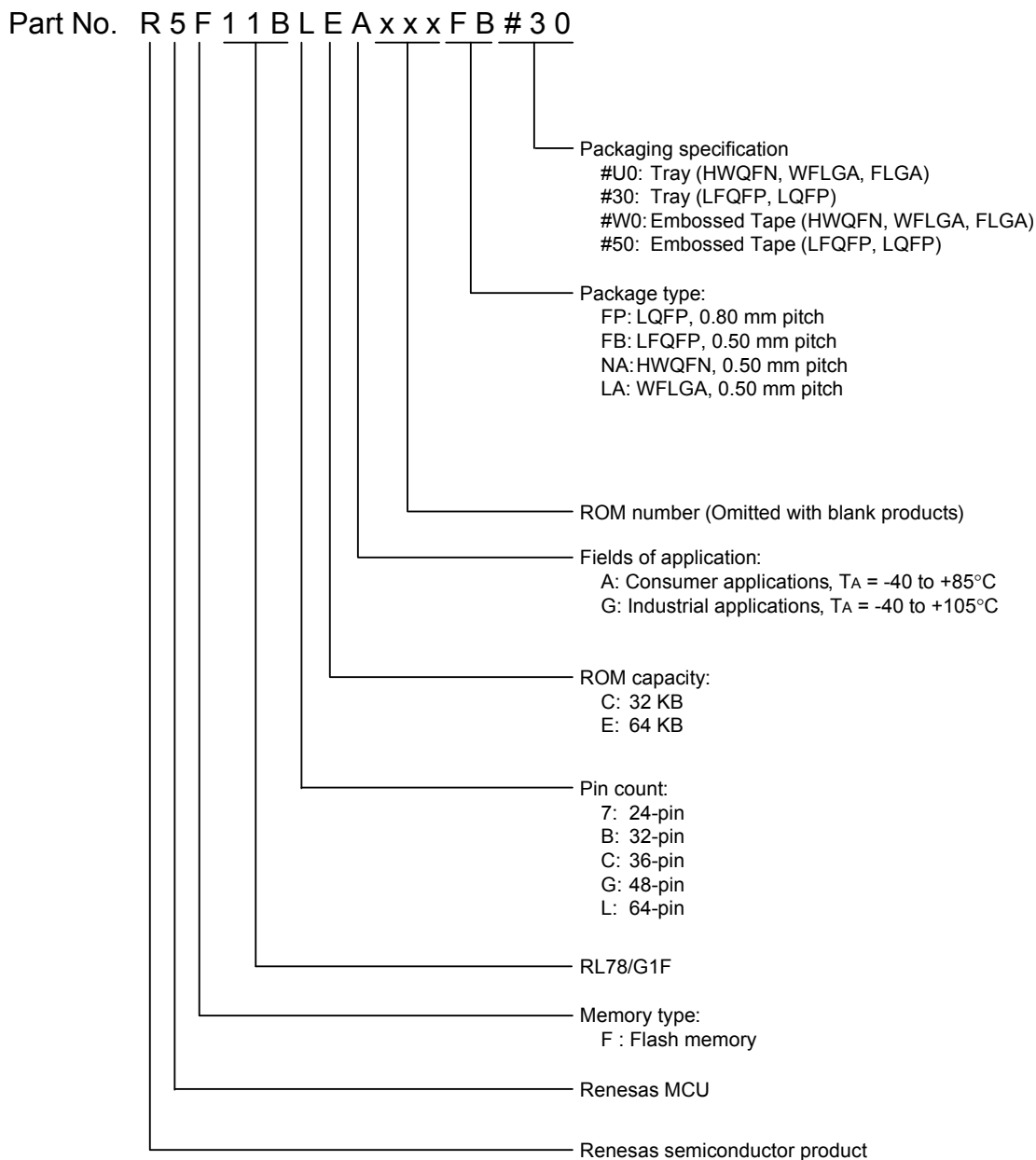

Pin count	Package	Fields of Application <sup>Note</sup>	Ordering Part Number
24 pins	24-pin plastic HWQFN (4 × 4, 0.5 mm pitch)	A	R5F11B7CANA#U0, R5F11B7EANA#U0, R5F11B7CANA#W0, R5F11B7EANA#W0
		G	R5F11B7CGNA#U0, R5F11B7EGNA#U0, R5F11B7CGNA#W0, R5F11B7EGNA#W0
32 pins	32-pin plastic LQFP (7 × 7, 0.8 mm pitch)	A	R5F11BBCAFP#30, R5F11BBEAFP#30, R5F11BBCAFP#50, R5F11BBEAFP#50
		G	R5F11BBCGFP#30, R5F11BBEGFP#30, R5F11BBCGFP#50, R5F11BBEGFP#50
36 pins	36-pin plastic WFLGA (4 × 4 mm, 0.5 mm pitch)	A	R5F11BCCALA#U0, R5F11BCEALA#U0, R5F11BCCALA#W0, R5F11BCEALA#W0
		G	R5F11BCCGLA#U0, R5F11BCEGLA#U0, R5F11BCCGLA#W0, R5F11BCEGLA#W0
48 pins	48-pin plastic LFQFP (7 × 7 mm, 0.5 mm pitch)	A	R5F11BGCAF#30, R5F11BGEAF#30, R5F11BGCAF#50, R5F11BGEAF#50
		G	R5F11BGC#30, R5F11BGE#30, R5F11BGC#50, R5F11BGE#50
64 pins	64-pin plastic LFQFP (10 × 10 mm, 0.5 mm pitch)	A	R5F11BLCAF#30, R5F11BLEAF#30, R5F11BLCAF#50, R5F11BLEAF#50
		G	R5F11BLC#30, R5F11BLE#30, R5F11BLC#50, R5F11BLE#50

**Note** For the fields of application, refer to **Figure 1 - 1 Part Number, Memory Size, and Package of RL78/G1F**.

**Caution** The ordering part numbers represent the numbers at the time of publication. For the latest ordering part numbers, refer to the target product page of the Renesas Electronics website.

### 1.3 Pin Configuration (Top View)

#### 1.3.1 24-pin products

- 24-pin plastic HWQFN (4 × 4 mm, 0.5 mm pitch)

<R>

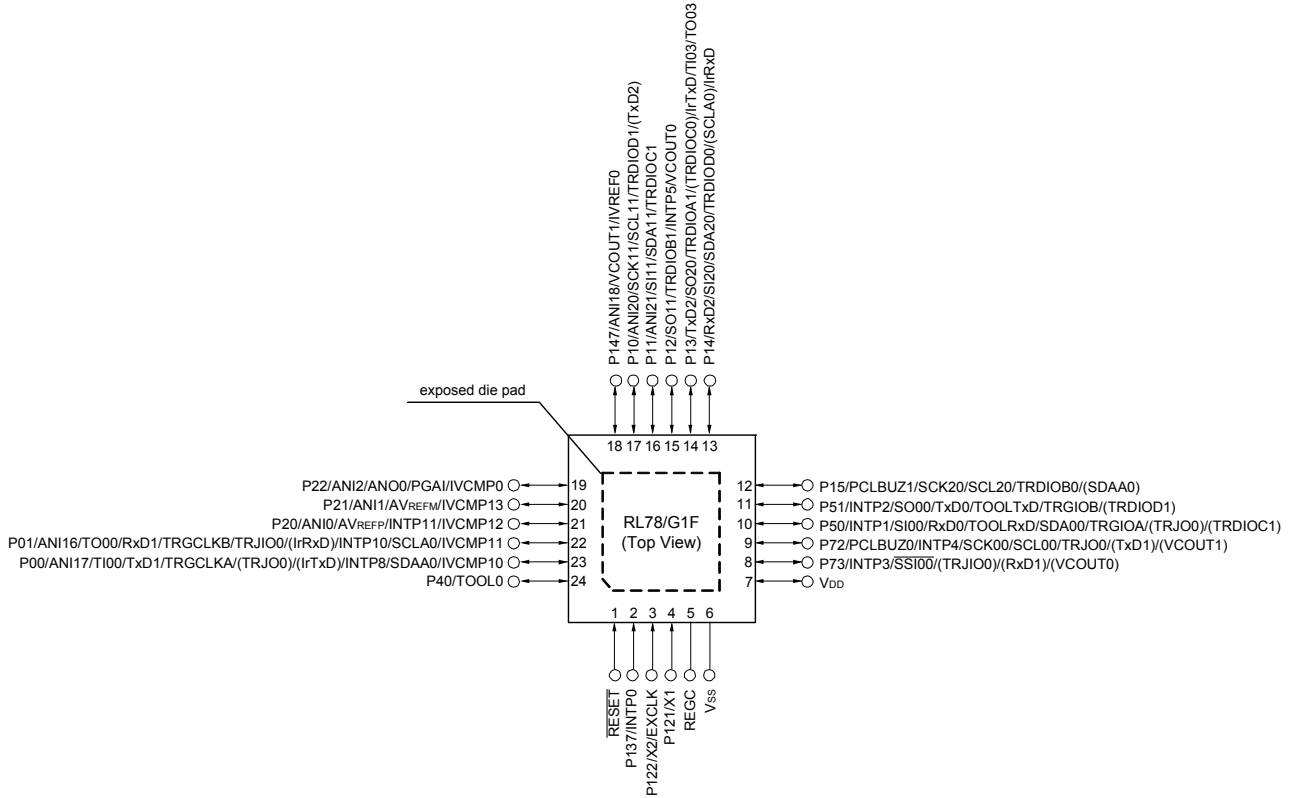

**Caution** Connect the REGC pin to V<sub>SS</sub> pin via a capacitor (0.47 to 1 μF).

**Remark 1.** For pin identification, see 1.4 Pin Identification.

**Remark 2.** Functions in parentheses in the above figure can be assigned via settings in the peripheral I/O redirection registers 0 to 3 (PIOR0 to PIOR3).

### 1.3.2 32-pin products

- 32-pin plastic LQFP (7 × 7 mm, 0.8 mm pitch)

<R>

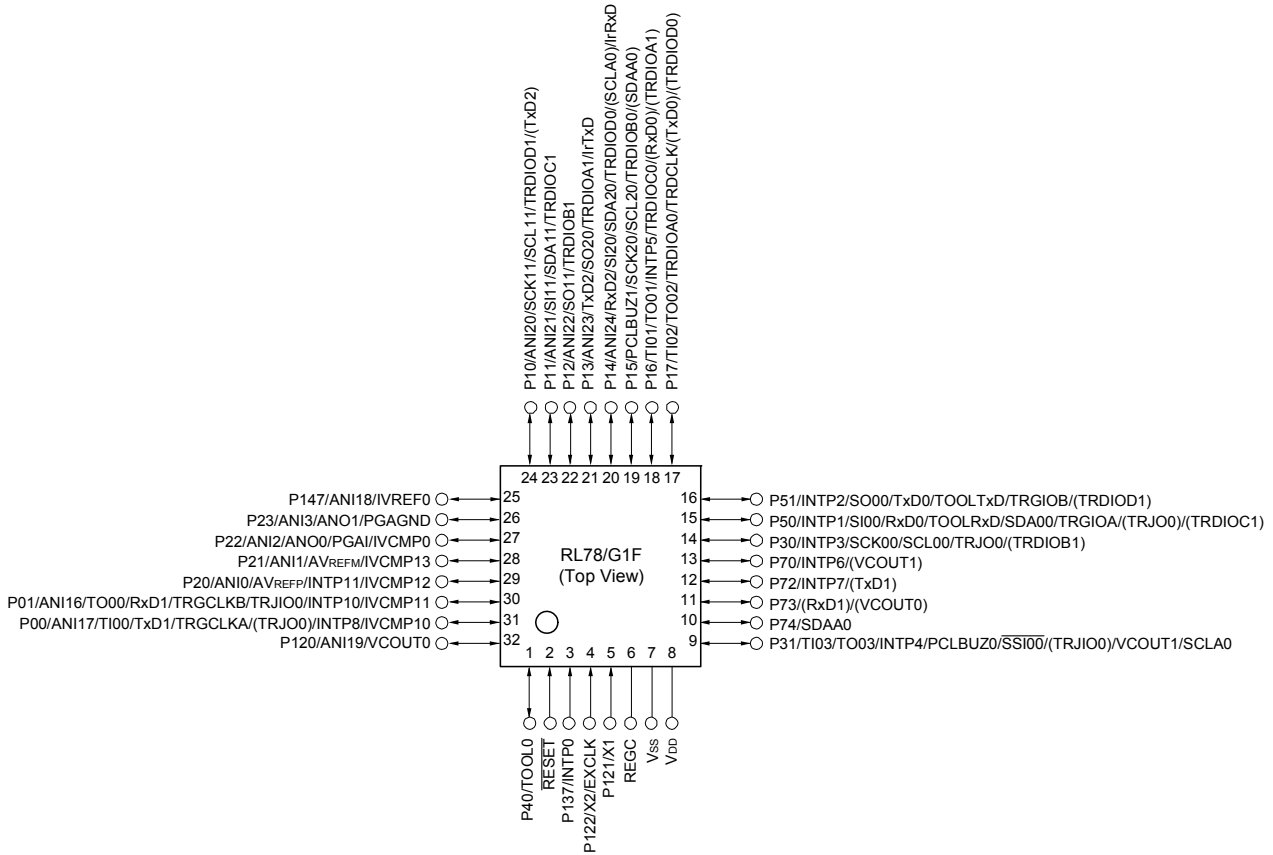

**Caution** Connect the REGC pin to V<sub>SS</sub> pin via a capacitor (0.47 to 1 μF).

**Remark 1.** For pin identification, see 1.4 Pin Identification.

**Remark 2.** Functions in parentheses in the above figure can be assigned via settings in the peripheral I/O redirection registers 0 to 3 (PIOR0 to PIOR3).

### 1.3.3 36-pin products

- 36-pin plastic WFLGA (4 × 4 mm, 0.5 mm pitch)

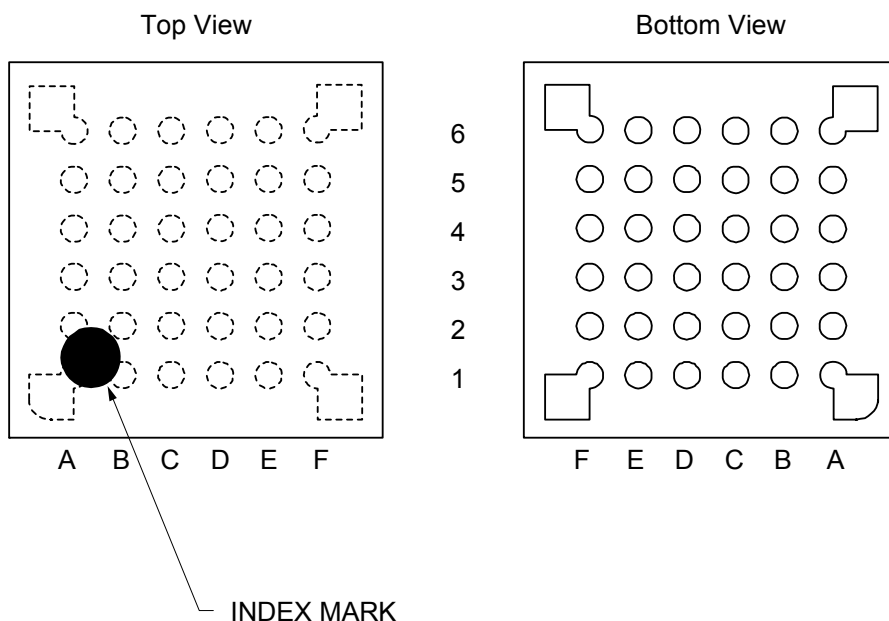

	A	B	C	D	E	F	
6	EVDD0	VDD	P121/X1	P122/X2/EXCLK	P137/INTP0	P40/TOOL0	6
5	P61/SDAA0	P60/SCLA0	Vss	REGC	RESET	P124/XT2/ EXCLKS	5
4	P31/TI03/TO03/ INTP4/PCLBUZ0/ SSI00/(TRJIO0)/ VCOUT1	P14/ANI24/RxD2/ SI20/SDA20/ TRDIOD0/ (SCLA0)/IrRxD	P20/ANI0/ AVREFP/IVCMP12/ INTP11	P21/ANI1/ AVREFM/IVCMP13	P01/ANI16/TO00/ RxD1/TRGCLKB/ TRJIO0/INTP10/ IVCMP11	P123/XT1	4
3	P50/INTP1/SI00/ RxD0/TOOLRxD/ SDA00/TRGIOA/ (TRJO0)/ (TRDIOC1)	P70/INTP6/ (VCOUT0)/ (VCOUT1)	P15/PCLBUZ1/ SCK20/SCL20/ TRDIOB0/ (SDAA0)	P23/ANI3/ANO1/ PGAGND	P00/ANI17/TI00/ TxD1/TRGCLKA/ (TRJO0)/INTP8/ IVCMP10	P120/ANI19/ VCOUT0	3
2	P30/INTP3/ RTC1HZ/SCK00/ SCL00/TRJO0/ (TRDIOB1)	P16/TI01/TO01/ INTP5/TRDIOC0/ (RxD0)/ (TRDIOA1)	P12/ANI22/SO11/ TRDIOB1	P11/ANI21/SI11/ SDA11/TRDIOC1	P24/ANI4	P22/ANI2/ANO0/ PGAI/IVCMP0	2
1	P51/INTP2/SO00/ TxD0/TOOLTxD/ TRGIOB/ (TRDIOD1)	P17/TI02/TO02/ TRDIOA0/ TRDCLK0/(TxD0)/ (TRDIOD0)	P13/ANI23/TxD2/ SO20/TRDIOA1/ IrTxD	P10/ANI20/ SCK11/SCL11/ TRDIOD1/(TxD2)	P147/ANI18/ IVREF0	P25/ANI5	1
	A	B	C	D	E	F	

**Caution 1.** Connect the REGC pin to Vss pin via a capacitor (0.47 to 1 μF).

**Caution 2.** Make VDD pin the potential that is higher than EVDD0 pin.

**Remark 1.** For pin identification, see 1.4 Pin Identification.

**Remark 2.** Functions in parentheses in the above figure can be assigned via settings in the peripheral I/O redirection registers 0 to 3 (PIOR0 to PIOR3).

**Remark 3.** When using the microcontroller for an application where the noise generated inside the microcontroller must be reduced, it is recommended to supply separate powers to the VDD and EVDD0 pins.

### 1.3.4 48-pin products

- 48-pin plastic LQFP (7 × 7 mm, 0.5 mm pitch)

<R>

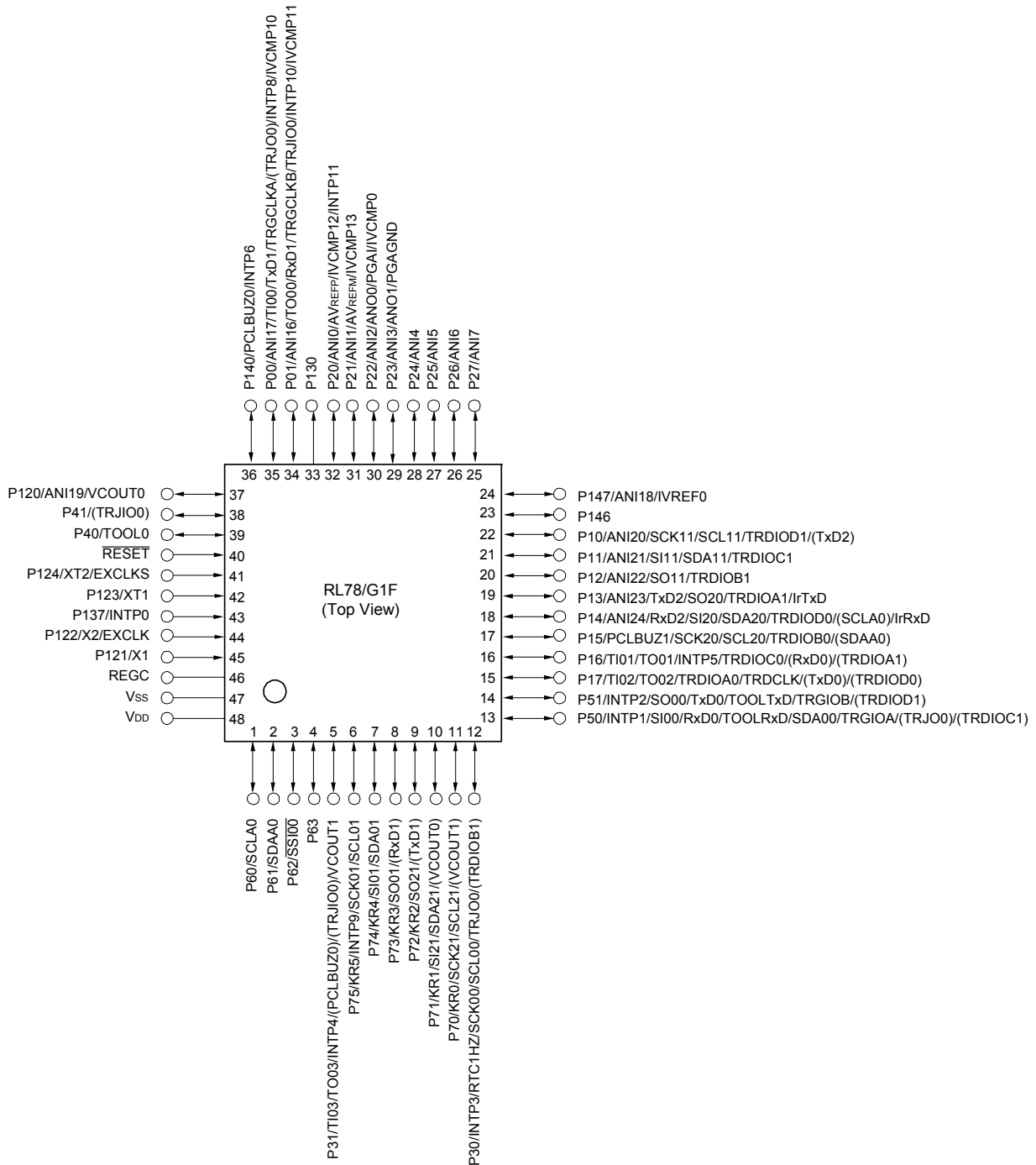

**Caution** Connect the REGC pin to VSS pin via a capacitor (0.47 to 1 μF).

**Remark 1.** For pin identification, see 1.4 Pin Identification.

**Remark 2.** Functions in parentheses in the above figure can be assigned via settings in the peripheral I/O redirection registers 0 to 3 (PIOR0 to PIOR3).



### 1.3.5 64-pin products

- 64-pin plastic LQFP (10 × 10 mm, 0.5 mm pitch)

<R>

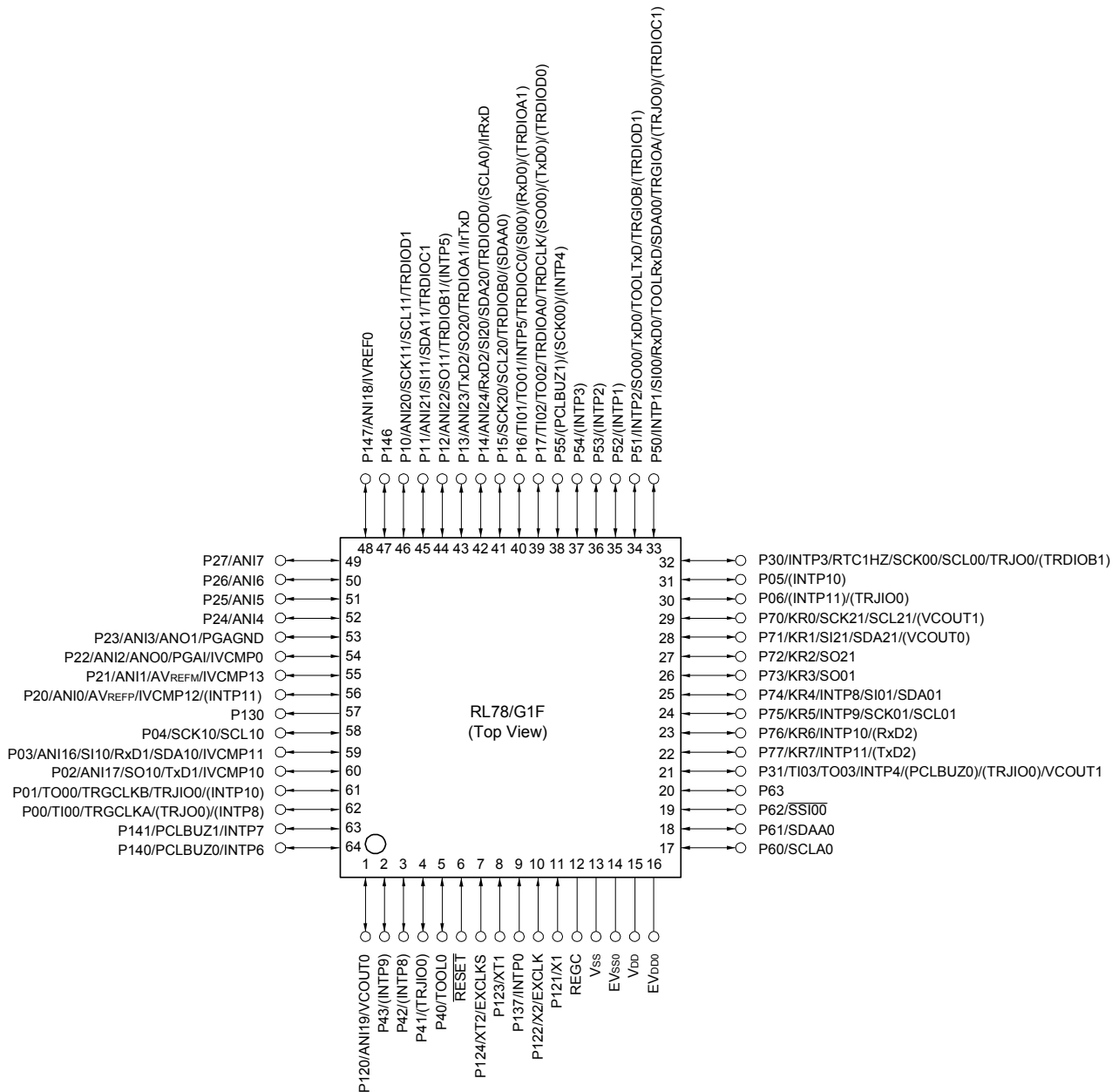

- Caution 1.** Make EVSS0 pin the same potential as Vss pin.
- Caution 2.** Make VDD pin the potential that is higher than EVDD0 pin.
- Caution 3.** Connect the REGC pin to Vss pin via a capacitor (0.47 to 1 μF).

- Remark 1.** For pin identification, see 1.4 Pin Identification.
- Remark 2.** When using the microcontroller for an application where the noise generated inside the microcontroller must be reduced, it is recommended to supply separate powers to the VDD and EVDD0 pins and connect the Vss and EVSS0 pins to separate ground lines.
- Remark 3.** Functions in parentheses in the above figure can be assigned via settings in the peripheral I/O redirection registers 0 to 3 (PIOR0 to PIOR3).

## 1.4 Pin Identification

ANI0 to ANI7:	Analog input	PGAI:	PGA input
ANI16 to ANI24:	Analog input	PGAGND:	PGA input
ANO0, ANO1:	Analog output	RTC1HZ:	Real-time clock correction clock (1 Hz) output
AVREFM:	Analog reference voltage minus	RxD0 to RxD2:	Receive data
AVREFP:	Analog reference voltage plus	SCK00, SCK01, SCK10:	Serial clock input/output
EVDD0:	Power supply for port	SCK11, SCK20, SCK21:	Serial clock input/output
EVSS0:	Ground for port	SCLA0:	Serial clock input/output
EXCLK:	External clock input (main system clock)	SCL00, SCL01, SCL10, SCL11:	Serial clock output
EXCLKS:	External clock input (subsystem clock)	SCL20, SCL21:	Serial clock output
INTP0 to INTP11:	External interrupt input	SDAA0:	Serial data input/output
IrRxD:	Receive Data for IrDA	SDA00, SDA01, SDA10:	Serial data input/output
IrTxD:	Transmit Data for IrDA	SDA11, SDA20, SDA21:	Serial data input/output
IVCMP0:	Comparator 0 input	SI00, SI01, SI10, SI11:	Serial data input
IVCMP10 to IVCMP13:	Comparator 1 input / reference input	SI20, SI21:	Serial data input
IVREF0:	Comparator 0 reference input	SO00, SO01, SO10:	Serial data output
KR0 to KR7:	Key return	SO11, SO20, SO21:	Serial data output
P00 to P06:	Port 0	<u>SSI00</u> :	Serial interface chip select input
P10 to P17:	Port 1	TI00 to TI03:	Timer input
P20 to P27:	Port 2	TO00 to TO03:	Timer output
P30, P31:	Port 3	TRJ00:	Timer output
P40 to P43:	Port 4	TOOL0:	Data input/output for tool
P50 to P55:	Port 5	TOOLRxD, TOOLTxD:	Data input/output for external device
P60 to P63:	Port 6	TRDCLK, TRGCLKA:	Timer external input clock
P70 to P77:	Port 7	TRGCLKB:	Timer external Input clock
P120 to P124:	Port 12	TRDIOA0, TRDIOB0:	Timer input/output
P130, P137	Port 13	TRDIOC0, TRDIOD0:	Timer input/output
P140, P141, P146,	Port 14	TRDIOA1, TRDIOB1:	Timer input/output
P147:		TRDIOC1, TRDIOD1:	Timer input/output
PCLBUZ0, PCLBUZ1:	Programmable clock output/ buzzer output	TRGIOA, TRGIOB, TRJIO0:	Timer input/output
REGC:	Regulator capacitance	TxD0 to TxD2:	Transmit data
<u>RESET</u> :	Reset	VCOUT0, VCOUT1:	Comparator output
		VDD:	Power supply
		VSS:	Ground
		X1, X2:	Crystal oscillator (main system clock)
		XT1, XT2:	Crystal oscillator (subsystem clock)

### 1.5 Block Diagram

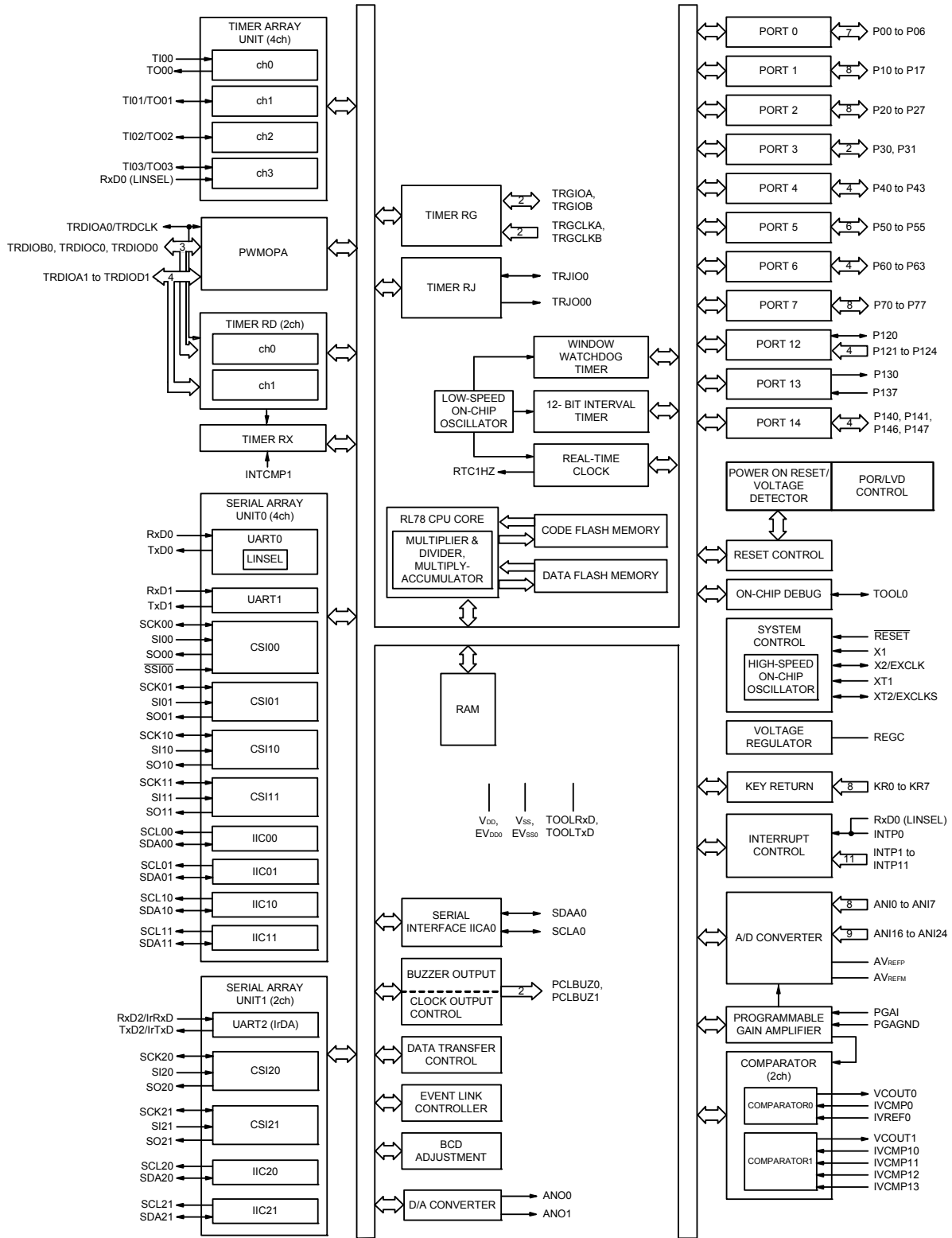

**Remark** Block diagram of 64-pin products is shown as an example. For difference of the block diagram other than 64-pin products, refer to 1.6 Outline of Functions.

## 1.6 Outline of Functions

**Caution** This outline describes the functions at the time when Peripheral I/O redirection register 0, 1 (PIOR0, 1) are set to 00H.

(1/2)

Item		24-pin	32-pin	36-pin	48-pin	64-pin
		R5F11B7x (x = C, E)	R5F11BBx (x = C, E)	R5F11BCx (x = C, E)	R5F11BGx (x = C, E)	R5F11BLx (x = C, E)
Code flash memory (KB)		32, 64	32, 64	32, 64	32, 64	32, 64
Data flash memory (KB)		4	4	4	4	4
RAM (KB)		5.5 Note	5.5 Note	5.5 Note	5.5 Note	5.5 Note
Address space		1 MB				
Main system clock	High-speed system clock	X1 (crystal/ceramic) oscillation, external main system clock input (EXCLK) HS (high-speed main) mode: 1 to 20 MHz ( $V_{DD} = 2.7$ to 5.5 V), HS (high-speed main) mode: 1 to 16 MHz ( $V_{DD} = 2.4$ to 5.5 V), LS (low-speed main) mode: 1 to 8 MHz ( $V_{DD} = 1.8$ to 2.7 V), LV (low-voltage main) mode: 1 to 4 MHz ( $V_{DD} = 1.6$ to 1.8 V)				
	High-speed on-chip oscillator clock (f <sub>IH</sub> )	HS (high-speed main) mode: 1 to 32 MHz ( $V_{DD} = 2.7$ to 5.5 V), HS (high-speed main) mode: 1 to 16 MHz ( $V_{DD} = 2.4$ to 5.5 V), LS (low-speed main) mode: 1 to 8 MHz ( $V_{DD} = 1.8$ to 5.5 V), LV (low-voltage main) mode: 1 to 4 MHz ( $V_{DD} = 1.6$ to 5.5 V)				
Subsystem clock		—		XT1 (crystal) oscillation, external subsystem clock input (EXCLKS) 32.768 kHz		
Low-speed on-chip oscillator clock		15 kHz (TYP.): $V_{DD} = 1.6$ to 5.5 V				
General-purpose register		8 bits × 32 registers (8 bits × 8 registers × 4 banks)				
Minimum instruction execution time		0.03125 μs (High-speed on-chip oscillator clock: f <sub>IH</sub> = 32 MHz operation)				
		0.05 μs (High-speed system clock: f <sub>MX</sub> = 20 MHz operation)				
		—		30.5 μs (Subsystem clock: f <sub>SUB</sub> = 32.768 kHz operation)		
Instruction set		<ul style="list-style-type: none"> <li>• Data transfer (8/16 bits)</li> <li>• Adder and subtractor/logical operation (8/16 bits)</li> <li>• Multiplication (8 bits × 8 bits, 16 bits × 16 bits), Division (16 bits ÷ 16 bits, 32 bits ÷ 32 bits)</li> <li>• Multiplication and Accumulation (16 bits × 16 bits + 32 bits)</li> <li>• Rotate, barrel shift, and bit manipulation (Set, reset, test, and Boolean operation), etc.</li> </ul>				
I/O port	Total	20	28	31	44	58
	CMOS I/O	17 (N-ch O.D. output [ $V_{DD}$ withstand voltage]: 10)	25 (N-ch O.D. output [ $V_{DD}$ withstand voltage]: 12)	24 (N-ch O.D. output [ $V_{DD}$ withstand voltage]: 10)	34 (N-ch O.D. output [ $V_{DD}$ withstand voltage]: 12)	48 (N-ch O.D. output [ $V_{DD}$ withstand voltage]: 12)
	CMOS input	3	3	5	5	5
	CMOS output	—	—	—	1	1
	N-ch open-drain I/O (6 V tolerance)	—	—	2	4	4
Timer	16-bit timer	9 channels (TAU: 4 channels, Timer RJ: 1 channel, Timer RD: 2 channels (with PWMOPA), Timer RX: 1 channel, Timer RG: 1 channel)				
	Watchdog timer	1 channel				
	Real-time clock (RTC)	1 channel				
	12-bit interval timer	1 channel				
	Timer output	Timer outputs: 13 channels PWM outputs: 8 channels	Timer outputs: 16 channels PWM outputs: 9 channels			
	RTC output	—			1 • 1 Hz (subsystem clock: f <sub>SUB</sub> = 32.768 kHz)	

**Note** This is about 4.5 KB when the self-programming function and data flash function are used (For details, see CHAPTER 3 in the RL78/G1F User's Manual).

(2/2)

Item	24-pin	32-pin	36-pin	48-pin	64-pin
	R5F11B7x (x = C, E)	R5F11BBx (x = C, E)	R5F11BCx (x = C, E)	R5F11BGx (x = C, E)	R5F11BLx (x = C, E)
Clock output/buzzer output	2	2	2	2	2
	<ul style="list-style-type: none"> <li>• 2.44 kHz, 4.88 kHz, 9.76 kHz, 1.25 MHz, 2.5 MHz, 5 MHz, 10 MHz (Main system clock: f<sub>MAIN</sub> = 20 MHz operation)</li> </ul>				
8/10-bit resolution A/D converter	8 channels	13 channels	15 channels	17 channels	17 channels
8-bit D/A converter	1 channel	2 channels			
Comparator	2 channels				
Programmable gain amplifier (PGA)	1 channel				
Serial interface	[24-pin, 32-pin, 36-pin products] <ul style="list-style-type: none"> <li>• CSI: 1 channel/UART (UART supporting LIN-bus): 1 channel/simplified I<sup>2</sup>C: 1 channel</li> <li>• CSI: 1 channel/UART: 1 channel/simplified I<sup>2</sup>C: 1 channel</li> <li>• CSI: 1 channel/UART: 1 channel/simplified I<sup>2</sup>C: 1 channel</li> </ul> [48-pin products] <ul style="list-style-type: none"> <li>• CSI: 2 channels/UART (UART supporting LIN-bus): 1 channel/simplified I<sup>2</sup>C: 2 channels</li> <li>• CSI: 1 channel/UART: 1 channel/simplified I<sup>2</sup>C: 1 channel</li> <li>• CSI: 2 channels/UART: 1 channel/simplified I<sup>2</sup>C: 2 channels</li> </ul> [64-pin products] <ul style="list-style-type: none"> <li>• CSI: 2 channels/UART (UART supporting LIN-bus): 1 channel/simplified I<sup>2</sup>C: 2 channels</li> <li>• CSI: 2 channels/UART: 1 channel/simplified I<sup>2</sup>C: 2 channels</li> <li>• CSI: 2 channels/UART: 1 channel/simplified I<sup>2</sup>C: 2 channels</li> </ul>				
	I <sup>2</sup> C bus	1 channel	1 channel	1 channel	1 channel
Data transfer controller (DTC)	30 sources	32 sources	31 sources	32 sources	33 sources
Event link controller (ELC)	Event input	21	21	21	22
	Event trigger output	9	10	10	10
Vectored interrupt sources	Internal	25	25	25	25
	External	9	11	10	12
Key interrupt	—	—	—	6	8
Reset	<ul style="list-style-type: none"> <li>• Reset by <math>\overline{\text{RESET}}</math> pin</li> <li>• Internal reset by watchdog timer</li> <li>• Internal reset by power-on-reset</li> <li>• Internal reset by voltage detector</li> <li>• Internal reset by illegal instruction execution <sup>Note</sup></li> <li>• Internal reset by RAM parity error</li> <li>• Internal reset by illegal-memory access</li> </ul>				
Power-on-reset circuit	<ul style="list-style-type: none"> <li>• Power-on-reset: 1.51 ±0.04 V (T<sub>A</sub> = -40 to +85°C) 1.51 ±0.06 V (T<sub>A</sub> = -40 to +105°C)</li> <li>• Power-down-reset: 1.50 ±0.04 V (T<sub>A</sub> = -40 to +85°C) 1.50 ±0.06 V (T<sub>A</sub> = -40 to +105°C)</li> </ul>				
Voltage detector	[T <sub>A</sub> = -40 to +85°C] <ul style="list-style-type: none"> <li>• Rising edge: 1.67 ±0.03 V to 4.00 ±0.08 V (14 stages)</li> <li>• Falling edge: 1.63 ±0.03 V to 3.98 ±0.08 V (14 stages)</li> </ul> [T <sub>A</sub> = -40 to +105°C (G: Industrial applications)] <ul style="list-style-type: none"> <li>• Rising edge: 2.61 ±0.1 V to 4.06 ±0.16 V (8 stages)</li> <li>• Falling edge: 2.55 ±0.1 V to 3.98 ±0.15 V (8 stages)</li> </ul>				
On-chip debug function	Provided				
Power supply voltage	V <sub>DD</sub> = 1.6 to 5.5 V (T <sub>A</sub> = -40 to +85°C) V <sub>DD</sub> = 2.4 to 5.5 V (T <sub>A</sub> = -40 to +105°C)				
Operating ambient temperature	T <sub>A</sub> = -40 to +85°C (A: Consumer applications), T <sub>A</sub> = -40 to +105°C (Industrial applications),				

The illegal instruction is generated when instruction code FFH is executed.

Reset by the illegal instruction execution not is issued by emulation with the in-circuit emulator or on-chip debug emulator.

## 2. ELECTRICAL SPECIFICATIONS (TA = -40 to +85°C)

This chapter describes the following electrical specifications.

Target products A: Consumer applications TA = -40 to +85°C

R5F11BxxAxx

G: Industrial applications when TA = -40 to +105°C products is used in the range of TA = -40 to +85°C

R5F11BxxGxx

**Caution 1.** The RL78 microcontrollers have an on-chip debug function, which is provided for development and evaluation. Do not use the on-chip debug function in products designated for mass production, because the guaranteed number of rewritable times of the flash memory may be exceeded when this function is used, and product reliability therefore cannot be guaranteed. Renesas Electronics is not liable for problems occurring when the on-chip debug function is used.

**Caution 2.** With products not provided with an EVDD0, EVSS0 pin, replace EVDD0 with VDD, or replace EVSS0 with VSS.

**Caution 3.** The pins mounted depend on the product. Refer to 2.1 Port Functions to 2.2.1 Functions for each product in the RL78/G1F User's Manual.

## 2.1 Absolute Maximum Ratings

### Absolute Maximum Ratings

(1/2)

Parameter	Symbols	Conditions	Ratings	Unit
Supply voltage	V <sub>DD</sub>		-0.5 to +6.5	V
	EV <sub>DD0</sub>		-0.5 to +6.5	V
REGC pin input voltage	V <sub>IREGC</sub>	REGC	-0.3 to +2.8 and -0.3 to V <sub>DD</sub> +0.3 Note 1	V
Input voltage	V <sub>I1</sub>	P00 to P06, P10 to P17, P30, P31, P40 to P43, P50 to P55, P70 to P77, P120, P140, P141, P146, P147	-0.3 to EV <sub>DD0</sub> +0.3 and -0.3 to V <sub>DD</sub> +0.3 Note 2	V
	V <sub>I2</sub>	P60 to P63 (N-ch open-drain)	-0.3 to +6.5	V
	V <sub>I3</sub>	P20 to P27, P121 to P124, P137, EXCLK, EXCLKS, RESET	-0.3 to V <sub>DD</sub> +0.3 Note 2	V
Output voltage	V <sub>O1</sub>	P00 to P06, P10 to P17, P30, P31, P40 to P43, P50 to P55, P60 to P63, P70 to P77, P120, P130, P140, P141, P146, P147	-0.3 to EV <sub>DD0</sub> +0.3 and -0.3 to V <sub>DD</sub> +0.3 Note 2	V
	V <sub>O2</sub>	P20 to P27	-0.3 to V <sub>DD</sub> +0.3 Note 2	V
Analog input voltage	V <sub>AI1</sub>	ANI16 to ANI24	-0.3 to EV <sub>DD0</sub> +0.3 and -0.3 to AV <sub>REF</sub> (+) +0.3 Notes 2, 3	V
	V <sub>AI2</sub>	ANI0 to ANI7	-0.3 to V <sub>DD</sub> +0.3 and -0.3 to AV <sub>REF</sub> (+) +0.3 Notes 2, 3	V

**Note 1.** Connect the REGC pin to V<sub>SS</sub> via a capacitor (0.47 to 1 μF). This value regulates the absolute maximum rating of the REGC pin. Do not use this pin with voltage applied to it.

**Note 2.** Must be 6.5 V or lower.

**Note 3.** Do not exceed AV<sub>REF</sub> (+) + 0.3 V in case of A/D conversion target pin.

**Caution** Product quality may suffer if the absolute maximum rating is exceeded even momentarily for any parameter. That is, the absolute maximum ratings are rated values at which the product is on the verge of suffering physical damage, and therefore the product must be used under conditions that ensure that the absolute maximum ratings are not exceeded.

**Remark 1.** Unless specified otherwise, the characteristics of alternate-function pins are the same as those of the port pins.

**Remark 2.** AV<sub>REF</sub> (+): + side reference voltage of the A/D converter.

**Remark 3.** V<sub>SS</sub>: Reference voltage

**Absolute Maximum Ratings****(2/2)**

Parameter	Symbols	Conditions		Ratings	Unit
Output current, high	IOH1	Per pin	P00 to P06, P10 to P17, P30, P31, P40 to P43, P50 to P55, P70 to P77, P120, P130, P140, P141, P146, P147	-40	mA
		Total of all pins -170 mA	P00 to P04, P40 to P43, P120, P130, P140, P141	-70	mA
			P05, P06, P10 to P17, P30, P31, P50 to P55, P70 to P77, P146, P147	-100	mA
	IOH2	Per pin	P20 to P27	-0.5	mA
		Total of all pins		-2	mA
	Output current, low	IOL1	Per pin	P00 to P06, P10 to P17, P30, P31, P40-P43, P50 to P55, P60 to P63, P70 to P77, P120, P130, P140, P141, P146, P147	40
Total of all pins 170 mA			P00 to P04, P40 to P47, P120, P130, P140, P141	70	mA
			P05, P06, P10 to P17, P30, P31, P50 to P55, P70 to P77, P146, P147	100	mA
IOL2		Per pin	P20 to P27	1	mA
		Total of all pins		5	mA
Operating ambient temperature		TA	In normal operation mode		-40 to +85
	In flash memory programming mode				
Storage temperature	Tstg			-65 to +150	°C

**Caution** Product quality may suffer if the absolute maximum rating is exceeded even momentarily for any parameter. That is, the absolute maximum ratings are rated values at which the product is on the verge of suffering physical damage, and therefore the product must be used under conditions that ensure that the absolute maximum ratings are not exceeded.

**Remark** Unless specified otherwise, the characteristics of alternate-function pins are the same as those of the port pins.



## 2.2 Oscillator Characteristics

### 2.2.1 X1, XT1 characteristics

(TA = -40 to +85°C, 1.6 V ≤ EVDD0 = VDD ≤ 5.5 V, VSS = 0 V)

Resonator	Resonator	Conditions	MIN.	TYP.	MAX.	Unit
X1 clock oscillation frequency (fx) <sup>Note</sup>	Ceramic resonator/ crystal resonator	2.7 V ≤ VDD ≤ 5.5 V	1.0		20.0	MHz
		2.4 V ≤ VDD < 2.7 V	1.0		16.0	
		1.8 V ≤ VDD < 2.4 V	1.0		8.0	
		1.6 V ≤ VDD < 1.8 V	1.0		4.0	
XT1 clock oscillation frequency (fxT) <sup>Note</sup>	Crystal resonator		32	32.768	35	kHz

**Note** Indicates only permissible oscillator frequency ranges. Refer to **AC Characteristics** for instruction execution time. Request evaluation by the manufacturer of the oscillator circuit mounted on a board to check the oscillator characteristics.

**Caution** Since the CPU is started by the high-speed on-chip oscillator clock after a reset release, check the X1 clock oscillation stabilization time using the oscillation stabilization time counter status register (OSTC) by the user. Determine the oscillation stabilization time of the OSTC register and the oscillation stabilization time select register (OSTS) after sufficiently evaluating the oscillation stabilization time with the resonator to be used.

**Remark** When using the X1 oscillator and XT1 oscillator, refer to **5.4 System Clock Oscillator** in the RL78/G1F User's Manual.

### 2.2.2 On-chip oscillator characteristics

(TA = -40 to +85°C, 1.6 V ≤ EVDD0 = VDD ≤ 5.5 V, VSS = 0 V)

Oscillators	Parameters	Conditions	MIN.	TYP.	MAX.	Unit	
High-speed on-chip oscillator clock frequency Notes 1, 2	f <sub>IH</sub>	2.7 V ≤ VDD ≤ 5.5 V	1		32	MHz	
		2.4 V ≤ VDD < 2.7 V	1		16	MHz	
		1.8 V ≤ VDD < 2.4 V	1		8	MHz	
		1.6 V ≤ VDD < 1.8 V	1		4	MHz	
High-speed on-chip oscillator clock frequency accuracy		TA = -20 to +85°C	1.8 V ≤ VDD ≤ 5.5 V	-1		1	%
			1.6 V ≤ VDD < 1.8 V	-5		5	%
		TA = -40 to -20°C	1.8 V ≤ VDD < 5.5 V	-1.5		1.5	%
			1.6 V ≤ VDD < 1.8 V	-5.5		5.5	%
Low-speed on-chip oscillator clock frequency	f <sub>IL</sub>			15		kHz	
Low-speed on-chip oscillator clock frequency accuracy			-15		+15	%	

**Note 1.** High-speed on-chip oscillator frequency is selected with bits 0 to 4 of the option byte (000C2H) and bits 0 to 2 of the HOCODIV register.

**Note 2.** This only indicates the oscillator characteristics. Refer to **AC Characteristics** for instruction execution time.

## 2.3 DC Characteristics

### 2.3.1 Pin characteristics

(TA = -40 to +85°C, 1.6 V ≤ EVDD0 ≤ VDD ≤ 5.5 V, VSS = EVSS0 = 0 V)

Items	Symbol	Conditions	MIN.	TYP.	MAX.	Unit
Output current, high <sup>Note 1</sup>	IOH1	Per pin for P00 to P06, P10 to P17, P30, P31, P40 to P47, P50 to P55, P70 to P77, P120, P130, P140, P141, P146, P147			-10.0 Note 2	mA
		Total of P00 to P04, P40 to P43, P120, P130, P140, P141 (When duty ≤ 70% <sup>Note 3</sup> )	4.0 V ≤ EVDD0 ≤ 5.5 V		-55.0	mA
			2.7 V ≤ EVDD0 < 4.0 V		-10.0	mA
			1.8 V ≤ EVDD0 < 2.7 V		-5.0	mA
			1.6 V ≤ EVDD0 < 1.8 V		-2.5	mA
		Total of P05, P06, P10 to P17, P30, P31, P50 to P53, P70 to P77, P146, P147 (When duty ≤ 70% <sup>Note 3</sup> )	4.0 V ≤ EVDD0 ≤ 5.5 V		-80.0	mA
			2.7 V ≤ EVDD0 < 4.0 V		-19.0	mA
			1.8 V ≤ EVDD0 < 2.7 V		-10.0	mA
			1.6 V ≤ EVDD0 < 1.8 V		-5.0	mA
		Total of all pins (When duty ≤ 70% <sup>Note 3</sup> )			-135.0 Note 4	mA
	IOH2	Per pin for P20 to P27			-0.1 Note 2	mA
Total of all pins (When duty ≤ 70% <sup>Note 3</sup> )		1.6 V ≤ VDD ≤ 5.5 V		-1.5	mA	

**Note 1.** Value of current at which the device operation is guaranteed even if the current flows from the EVDD0, VDD pins to an output pin.

**Note 2.** Do not exceed the total current value.

**Note 3.** Specification under conditions where the duty factor ≤ 70%.

The output current value that has changed to the duty factor > 70% the duty ratio can be calculated with the following expression (when changing the duty factor from 70% to n%).

- Total output current of pins = (IOH × 0.7)/(n × 0.01)

<Example> Where n = 80% and IOH = -10.0 mA

$$\text{Total output current of pins} = (-10.0 \times 0.7)/(80 \times 0.01) \approx -8.7 \text{ mA}$$

However, the current that is allowed to flow into one pin does not vary depending on the duty factor.

A current higher than the absolute maximum rating must not flow into one pin.

**Note 4.** The applied current for the products for industrial application (R5F11BxxGxx) is -100 mA.

**Caution** P00, P02 to P04, P10, P11, P13 to P15, P17, P30, P43, P50 to P55, P71, P74 do not output high level in N-ch open-drain mode.

**Remark** Unless specified otherwise, the characteristics of alternate-function pins are the same as those of the port pins.

(TA = -40 to +85°C, 1.6 V ≤ EVDD0 ≤ VDD ≤ 5.5 V, Vss = EVss0 = 0 V)

(2/5)

Items	Symbol	Conditions	MIN.	TYP.	MAX.	Unit	
Output current, low <sup>Note 1</sup>	IOL1	Per pin for P00 to P06, P10 to P17, P30, P31, P40 to P43, P50 to P55, P70 to P77, P120, P130, P140, P141, P146, P147			20.0	mA Note 2	
					15.0		mA Note 2
		Total of P00 to P04, P40 to P43, P120, P130, P140, P141 (When duty ≤ 70% <sup>Note 3</sup> )	4.0 V ≤ EVDD0 ≤ 5.5 V		70.0	mA	
			2.7 V ≤ EVDD0 < 4.0 V		15.0		
			1.8 V ≤ EVDD0 < 2.7 V		9.0		
			1.6 V ≤ EVDD0 < 1.8 V		4.5		
		Total of P05, P06, P10 to P17, P30, P31, P50 to P55, P60 to P63, P70 to P77, P146, P147 (When duty ≤ 70% <sup>Note 3</sup> )	4.0 V ≤ EVDD0 ≤ 5.5 V		80.0	mA	
			2.7 V ≤ EVDD0 < 4.0 V		35.0		
			1.8 V ≤ EVDD0 < 2.7 V		20.0		
			1.6 V ≤ EVDD0 < 1.8 V		10.0		
	Total of all pins (When duty ≤ 70% <sup>Note 3</sup> )					150.0	mA
	IOL2	Per pin for P20 to P27			0.4	mA Note 2	
		Total of all pins (When duty ≤ 70% <sup>Note 3</sup> )	1.6 V ≤ VDD ≤ 5.5 V				5.0

**Note 1.** Value of current at which the device operation is guaranteed even if the current flows from an output pin to the EVss0 and Vss pins.

**Note 2.** Do not exceed the total current value.

**Note 3.** Specification under conditions where the duty factor ≤ 70%.

The output current value that has changed to the duty factor > 70% the duty ratio can be calculated with the following expression (when changing the duty factor from 70% to n%).

- Total output current of pins =  $(I_{OL} \times 0.7)/(n \times 0.01)$

<Example> Where n = 80% and IOL = 10.0 mA

$$\text{Total output current of pins} = (10.0 \times 0.7)/(80 \times 0.01) \approx 8.7 \text{ mA}$$

However, the current that is allowed to flow into one pin does not vary depending on the duty factor.

A current higher than the absolute maximum rating must not flow into one pin.

**Remark** Unless specified otherwise, the characteristics of alternate-function pins are the same as those of the port pins.

(TA = -40 to +85°C, 1.6 V ≤ EVDD0 ≤ VDD ≤ 5.5 V, VSS = EVSS0 = 0 V)

(3/5)

Items	Symbol	Conditions	MIN.	TYP.	MAX.	Unit	
Input voltage, high	V <sub>IH1</sub>	P00 to P06, P10 to P17, P30, P31, P40 to P43, P50 to P55, P70 to P77, P120, P140, P141, P146, P147	Normal input buffer	0.8 EVDD0		EVDD0	V
	V <sub>IH2</sub>	P01, P03, P04, P10, P14 to P17, P30, P43, P50, P53 to P55,	TTL input buffer 4.0 V ≤ EVDD0 ≤ 5.5 V	2.2		EVDD0	V
			TTL input buffer 3.3 V ≤ EVDD0 < 4.0 V	2.0		EVDD0	V
			TTL input buffer 1.6 V ≤ EVDD0 < 3.3 V	1.5		EVDD0	V
	V <sub>IH3</sub>	P20 to P27 (when P20 is used as a port pin)		0.7 VDD		VDD	V
	V <sub>IH4</sub>	P60 to P63		0.7 EVDD0		6.0	V
V <sub>IH5</sub>	P121 to P123, P137, EXCLK, EXCLKS, $\overline{\text{RESET}}$ (when P20 is used as INTP11 pin)		0.8 VDD		VDD	V	
Input voltage, low	V <sub>IL1</sub>	P00 to P06, P10 to P17, P30, P31, P40 to P43, P50 to P55, P70 to P77, P120, P140, P141, P146, P147	Normal input buffer	0		0.2 EVDD0	V
	V <sub>IL2</sub>	P01, P03, P04, P10, P14 to P17, P30, P43, P50, P53 to P55,	TTL input buffer 4.0 V ≤ EVDD0 ≤ 5.5 V	0		0.8	V
			TTL input buffer 3.3 V ≤ EVDD0 < 4.0 V	0		0.5	V
			TTL input buffer 1.6 V ≤ EVDD0 < 3.3 V	0		0.32	V
	V <sub>IL3</sub>	P20 to P27 (when P20 is used as a port pin)		0		0.3 VDD	V
	V <sub>IL4</sub>	P60 to P63		0		0.3 EVDD0	V
V <sub>IL5</sub>	P121 to P124, P137, EXCLK, EXCLKS, $\overline{\text{RESET}}$ (when P20 is used as INTP11 pin)		0		0.2 VDD	V	

**Caution** The maximum value of V<sub>IH</sub> of pins P00, P02 to P04, P10, P11, P13 to P15, P17, P30, P43, P50 to P55, P71, P74 is EVDD0, even in the N-ch open-drain mode.

**Remark** Unless specified otherwise, the characteristics of alternate-function pins are the same as those of the port pins.

(TA = -40 to +85°C, 1.6 V ≤ EVDD0 ≤ VDD ≤ 5.5 V, VSS = EVSS0 = 0 V)

(4/5)

Items	Symbol	Conditions	MIN.	TYP.	MAX.	Unit
Output voltage, high	VOH1	P00 to P06, P10 to P17, P30, P31, P40 to P43, P50 to P55, P70 to P77, P120, P130, P140, P141, P146, P147	4.0 V ≤ EVDD0 ≤ 5.5 V, IOH1 = -10.0 mA	EVDD0 - 1.5		V
			4.0 V ≤ EVDD0 ≤ 5.5 V, IOH1 = -3.0 mA	EVDD0 - 0.7		V
			2.7 V ≤ EVDD0 ≤ 5.5 V, IOH1 = -2.0 mA	EVDD0 - 0.6		V
			1.8 V ≤ EVDD0 ≤ 5.5 V, IOH1 = -1.5 mA	EVDD0 - 0.5		V
			1.6 V ≤ EVDD0 < 1.8 V, IOH1 = -1.0 mA	EVDD0 - 0.5		V
	VOH2	P20 to P27	1.6 V ≤ VDD ≤ 5.5 V, IOH2 = -100 μA	VDD - 0.5		V
Output voltage, low	VOL1	P00 to P06, P10 to P17, P30, P31, P40 to P43, P50 to P55, P70 to P77, P120, P130, P140, P141, P146, P147	4.0 V ≤ EVDD0 ≤ 5.5 V, IOL1 = 20.0 mA		1.3	V
			4.0 V ≤ EVDD0 ≤ 5.5 V, IOL1 = 8.5 mA		0.7	V
			2.7 V ≤ EVDD0 ≤ 5.5 V, IOL1 = 3.0 mA		0.6	V
			2.7 V ≤ EVDD0 ≤ 5.5 V, IOL1 = 1.5 mA		0.4	V
			1.8 V ≤ EVDD0 ≤ 5.5 V, IOL1 = 0.6 mA		0.4	V
			1.6 V ≤ EVDD0 ≤ 5.5 V, IOL1 = 0.3 mA		0.4	V
	VOL2	P20 to P27	1.6 V ≤ VDD ≤ 5.5 V, IOL2 = 400 μA		0.4	V
	VOL3	P60 to P63	4.0 V ≤ EVDD0 ≤ 5.5 V, IOL3 = 15.0 mA		2.0	V
			4.0 V ≤ EVDD0 ≤ 5.5 V, IOL3 = 5.0 mA		0.4	V
			2.7 V ≤ EVDD0 ≤ 5.5 V, IOL3 = 3.0 mA		0.4	V
			1.8 V ≤ EVDD0 ≤ 5.5 V, IOL3 = 2.0 mA		0.4	V
			1.6 V ≤ EVDD0 ≤ 5.5 V, IOL3 = 1.0 mA		0.4	V

**Caution** P00, P02 to P04, P10, P11, P13 to P15, P17, P30, P43, P50 to P55, P71, P74 do not output high level in N-ch open-drain mode.

**Remark** Unless specified otherwise, the characteristics of alternate-function pins are the same as those of the port pins.

(TA = -40 to +85°C, 1.6 V ≤ EVDD0 ≤ VDD ≤ 5.5 V, VSS = EVSS0 = 0 V)

(5/5)

Items	Symbol	Conditions	MIN.	TYP.	MAX.	Unit		
Input leakage current, high	ILIH1	P00 to P06, P10 to P17, P30, P31, P40 to P43, P50 to P55, P70 to P77, P120, P140, P141, P146, P147	Vi = EVDD0			1	μA	
	ILIH2	P20 to P27, P137, $\overline{\text{RESET}}$	Vi = VDD			1	μA	
	ILIH3	P121 to P124 (X1, X2, EXCLK, XT1, XT2, EXCLKS)	Vi = VDD	In input port or external clock input		1	μA	
				In resonator connection		10	μA	
Input leakage current, low	ILIL1	P00 to P06, P10 to P17, P30, P31, P40 to P43, P50 to P55, P70 to P77, P120, P140, P141, P146, P147	Vi = EVSS0			-1	μA	
	ILIL2	P20 to P27, P137, $\overline{\text{RESET}}$	Vi = VSS			-1	μA	
	ILIL3	P121 to P124 (X1, X2, EXCLK, XT1, XT2, EXCLKS)	Vi = VSS	In input port or external clock input		-1	μA	
				In resonator connection		-10	μA	
On-chip pull-up resistance	Ru	P00 to P06, P10 to P17, P30, P31, P40 to P43, P50 to P55, P70 to P77, P120, P140, P141, P146, P147	Vi = EVSS0, In input port		10	20	100	kΩ

**Remark** Unless specified otherwise, the characteristics of alternate-function pins are the same as those of the port pins.

### 2.3.2 Supply current characteristics

(TA = -40 to +85°C, 1.6 V ≤ EVDD0 ≤ VDD ≤ 5.5 V, VSS = EVSS0 = 0 V)

Parameter	Symbol	Conditions				MIN.	TYP.	MAX.	Unit	
Supply current Note 1	IDD1	Operating mode	HS (high-speed main) mode Note 5	fHOCO = 64 MHz, fIH = 32 MHz Note 3	Basic operation	VDD = 5.0 V	2.4		mA	
						VDD = 3.0 V	2.4			
				fHOCO = 32 MHz, fIH = 32 MHz Note 3	Basic operation	VDD = 5.0 V	2.1			
						VDD = 3.0 V	2.1			
				HS (high-speed main) mode Note 5	fHOCO = 64 MHz, fIH = 32 MHz Note 3	Normal operation	VDD = 5.0 V	5.2		8.7
							VDD = 3.0 V	5.2		8.7
			fHOCO = 32 MHz, fIH = 32 MHz Note 3		Normal operation	VDD = 5.0 V	4.8	8.1		
						VDD = 3.0 V	4.8	8.1		
			fHOCO = 48 MHz, fIH = 24 MHz Note 3		Normal operation	VDD = 5.0 V	4.1	6.9		
						VDD = 3.0 V	4.1	6.9		
			fHOCO = 24 MHz, fIH = 24 MHz Note 3	Normal operation	VDD = 5.0 V	3.8	6.3			
					VDD = 3.0 V	3.8	6.3			
		fHOCO = 16 MHz, fIH = 16 MHz Note 3	Normal operation	VDD = 5.0 V	2.8	4.6				
				VDD = 3.0 V	2.8	4.6				
		LS (low-speed main) mode Note 5	fHOCO = 8 MHz, fIH = 8 MHz Note 3	Normal operation	VDD = 3.0 V	1.3	2.1			
					VDD = 2.0 V	1.3	2.1			
		LV (low-voltage main) mode Note 5	fHOCO = 4 MHz, fIH = 4 MHz Note 3	Normal operation	VDD = 3.0 V	1.3	1.9			
					VDD = 2.0 V	1.3	1.9			
		HS (high-speed main) mode Note 5	fMX = 20 MHz Note 2, VDD = 5.0 V	Normal operation	Square wave input	3.3	5.3			
					Resonator connection	3.5	5.5			
				Normal operation	Square wave input	3.3	5.3			
					Resonator connection	3.5	5.5			
			fMX = 10 MHz Note 2, VDD = 5.0 V	Normal operation	Square wave input	2	3.1			
					Resonator connection	2.1	3.2			
			fMX = 10 MHz Note 2, VDD = 3.0 V	Normal operation	Square wave input	2	3.1			
					Resonator connection	2.1	3.2			
		LS (low-speed main) mode Note 5	fMX = 8 MHz Note 2, VDD = 3.0 V	Normal operation	Square wave input	1.2	1.9			
					Resonator connection	1.2	2			
fMX = 8 MHz Note 2, VDD = 2.0 V	Normal operation		Square wave input	1.2	1.9					
			Resonator connection	1.2	2					
Subsystem clock operation	fSUB = 32.768 kHz Note 4 TA = -40°C	Normal operation	Square wave input	4.7	6.1					
			Resonator connection	4.7	6.1					
	fSUB = 32.768 kHz Note 4 TA = +25°C	Normal operation	Square wave input	4.7	6.1					
			Resonator connection	4.7	6.1					
	fSUB = 32.768 kHz Note 4 TA = +50°C	Normal operation	Square wave input	4.8	6.7					
			Resonator connection	4.8	6.7					
	fSUB = 32.768 kHz Note 4 TA = +70°C	Normal operation	Square wave input	4.8	7.5					
			Resonator connection	4.8	7.5					
fSUB = 32.768 kHz Note 4 TA = +85°C	Normal operation	Square wave input	5.4	8.9						
		Resonator connection	5.4	8.9						

(Notes and Remarks are listed on the next page.)

- Note 1.** Total current flowing into V<sub>DD</sub> and EV<sub>DD0</sub>, including the input leakage current flowing when the level of the input pin is fixed to V<sub>DD</sub>, EV<sub>DD0</sub> or V<sub>SS</sub>, EV<sub>SS0</sub>. The values below the MAX. column include the peripheral operation current. However, not including the current flowing into the A/D converter, LVD circuit, I/O port, and on-chip pull-up/pull-down resistors and the current flowing during data flash rewrite.
- Note 2.** When high-speed on-chip oscillator and subsystem clock are stopped.
- Note 3.** When high-speed system clock and subsystem clock are stopped.
- Note 4.** When high-speed on-chip oscillator and high-speed system clock are stopped. When AMPHS1 = 1 (Ultra-low power consumption oscillation). However, not including the current flowing into the RTC, 12-bit interval timer, and watchdog timer.
- Note 5.** Relationship between operation voltage width, operation frequency of CPU and operation mode is as below.
- |                             |   |
|-----------------------------|---|
| HS (high-speed main) mode:  | 2.7 V ≤ V <sub>DD</sub> ≤ 5.5 V@1 MHz to 32 MHz |
|                             | 2.4 V ≤ V <sub>DD</sub> ≤ 5.5 V@1 MHz to 16 MHz |
| LS (low-speed main) mode:   | 1.8 V ≤ V <sub>DD</sub> ≤ 5.5 V@1 MHz to 8 MHz  |
| LV (low-voltage main) mode: | 1.6 V ≤ V <sub>DD</sub> ≤ 5.5 V@1 MHz to 4 MHz  |
- Remark 1.** f<sub>MX</sub>: High-speed system clock frequency (X1 clock oscillation frequency or external main system clock frequency)
- Remark 2.** f<sub>HOCO</sub>: High-speed on-chip oscillator clock frequency (64 MHz max.)
- Remark 3.** f<sub>IH</sub>: High-speed on-chip oscillator clock frequency (32 MHz max.)
- Remark 4.** f<sub>SUB</sub>: Subsystem clock frequency (XT1 clock oscillation frequency)
- Remark 5.** Except subsystem clock operation, temperature condition of the TYP. value is TA = 25°C



(TA = -40 to +85°C, 1.6 V ≤ EVDD0 ≤ VDD ≤ 5.5 V, VSS = EVSS0 = 0 V)

(2/2)

Parameter	Symbol	Conditions		MIN.	TYP.	MAX.	Unit		
Supply current Note 1	IDD2 Note 2	HALT mode	HS (high-speed main) mode Note 7	fHOCO = 64 MHz, fIH = 32 MHz Note 4	VDD = 5.0 V	0.8	3.09	mA	
					VDD = 3.0 V	0.8	3.09		
				fHOCO = 32 MHz, fIH = 32 MHz Note 4	VDD = 5.0 V	0.54	2.4		
					VDD = 3.0 V	0.54	2.4		
				fHOCO = 48 MHz, fIH = 24 MHz Note 4	VDD = 5.0 V	0.62	2.4		
					VDD = 3.0 V	0.62	2.4		
			fHOCO = 24 MHz, fIH = 24 MHz Note 4	VDD = 5.0 V	0.44	1.83			
				VDD = 3.0 V	0.44	1.83			
			fHOCO = 16 MHz, fIH = 16 MHz Note 4	VDD = 5.0 V	0.4	1.38			
				VDD = 3.0 V	0.4	1.38			
			LS (low-speed main) mode Note 7	fHOCO = 8 MHz, fIH = 8 MHz Note 4	VDD = 3.0 V	260	790	μA	
				VDD = 2.0 V	260	790			
			LV (low-voltage main) mode Note 7	fHOCO = 4 MHz, fIH = 4 MHz Note 4	VDD = 3.0 V	420	830	μA	
				VDD = 2.0 V	420	830			
			HS (high-speed main) mode Note 7	fMX = 20 MHz Note 3, VDD = 5.0 V	Square wave input	0.28	1.55	mA	
					Resonator connection	0.49	1.74		
					fMX = 20 MHz Note 3, VDD = 3.0 V	Square wave input	0.28		1.55
					Resonator connection	0.49	1.74		
		fMX = 10 MHz Note 3, VDD = 5.0 V			Square wave input	0.19	0.86		
		Resonator connection			0.3	0.93			
		fMX = 10 MHz Note 3, VDD = 3.0 V		Square wave input	0.19	0.86			
				Resonator connection	0.3	0.93			
				LS (low-speed main) mode Note 7	fMX = 8 MHz Note 3, VDD = 3.0 V	Square wave input	95	640	μA
					Resonator connection	145	680		
					fMX = 8 MHz Note 3, VDD = 2.0 V	Square wave input	95	640	
					Resonator connection	145	680		
		Subsystem clock operation	fSUB = 32.768 kHz Note 5, TA = -40°C	Square wave input	0.25	0.57	μA		
				Resonator connection	0.44	0.76			
			fSUB = 32.768 kHz Note 5, TA = 25°C	Square wave input	0.3	0.57			
				Resonator connection	0.49	0.76			
fSUB = 32.768 kHz Note 5, TA = 50°C	Square wave input		0.36	1.17					
	Resonator connection		0.59	1.36					
fSUB = 32.768 kHz Note 5, TA = 70°C	Square wave input		0.49	1.97					
	Resonator connection		0.72	2.16					
fSUB = 32.768 kHz Note 5, TA = 85°C	Square wave input	0.97	3.37						
	Resonator connection	1.16	3.56						
IDD3 Note 6	STOP mode Note 8	TA = -40°C	0.18	0.51	μA				
		TA = +25°C	0.24	0.51					
		TA = +50°C	0.29	1.1					
		TA = +70°C	0.41	1.9					
		TA = +85°C	0.9	3.3					

(Notes and Remarks are listed on the next page.)



(TA = -40 to +85°C, 1.6 V ≤ EVDD0 ≤ VDD ≤ 5.5 V, VSS = EVSS0 = 0 V)

Parameter	Symbol	Conditions		MIN.	TYP.	MAX.	Unit
Low-speed on-chip oscillator operating current	IFIL Note 1				0.2		μA
RTC operating current	IRTC Notes 1, 2, 3				0.02		μA
12-bit interval timer operating current	IIT Notes 1, 2, 4				0.02		μA
Watchdog timer operating current	IWDT Notes 1, 2, 5	fIL = 15 kHz			0.22		μA
A/D converter operating current	IADC Notes 1, 6	When conversion at maximum speed	Normal mode, AVREFP = VDD = 5.0 V		1.3	1.7	mA
			Low voltage mode, AVREFP = VDD = 3.0 V		0.5	0.7	mA
A/D converter reference voltage current	IADREF Note 1				75		μA
Temperature sensor operating current	ITMPS Note 1				75		μA
D/A converter operating current	IDAC Notes 1, 11	Per D/A converter channel				1.5	mA
PGA operating current		Operation			480	700	μA
Comparator operating current	ICMP Notes 1, 12	Operation (per comparator channel, constant current for comparator included)	When the internal reference voltage is not in use		50	100	μA
			When the internal reference voltage is in use		60	110	μA
LVD operating current	ILVD Notes 1, 7				0.08		μA
Self-programming operating current	IFSP Notes 1, 9				2.5	12.2	mA
BGO operating current	IBGO Notes 1, 8				2.5	12.2	mA
SNOOZE operating current	ISNOZ Note 1	ADC operation	The mode is performed Note 10		0.5	0.6	mA
			The A/D conversion operations are performed, Low voltage mode, AVREFP = VDD = 3.0 V		1.2	1.44	
		CSI/JART operation		0.7	0.84		
		DTC operation		3.1			

**Note 1.** Current flowing to VDD.

**Note 2.** When high speed on-chip oscillator and high-speed system clock are stopped.

**Note 3.** Current flowing only to the real-time clock (RTC) (excluding the operating current of the low-speed on-chip oscillator and the XT1 oscillator). The supply current of the RL78 microcontrollers is the sum of the values of either IDD1 or IDD2, and IRTC, when the real-time clock operates in operation mode or HALT mode. When the low-speed on-chip oscillator is selected, IFIL should be added. IDD2 subsystem clock operation includes the operational current of the real-time clock.

**Note 4.** Current flowing only to the 12-bit interval timer (excluding the operating current of the low-speed on-chip oscillator and the XT1 oscillator). The supply current of the RL78 microcontrollers is the sum of the values of either IDD1 or IDD2, and IIT, when the 12-bit interval timer operates in operation mode or HALT mode. When the low-speed on-chip oscillator is selected, IFIL should be added.

**Note 5.** Current flowing only to the watchdog timer (including the operating current of the low-speed on-chip oscillator). The supply current of the RL78 microcontrollers is the sum of IDD1, IDD2 or IDD3 and IWDT when the watchdog timer is in operation.

**Note 6.** Current flowing only to the A/D converter. The supply current of the RL78 microcontrollers is the sum of IDD1 or IDD2 and IADC when the A/D converter operates in an operation mode or the HALT mode.

**Note 7.** Current flowing only to the LVD circuit. The supply current of the RL78 microcontrollers is the sum of IDD1, IDD2 or IDD3 and ILVD when the LVD circuit is in operation.

**Note 8.** Current flowing during programming of the data flash.

**Note 9.** Current flowing during self-programming.

**Note 10.** For shift time to the SNOOZE mode, see 26.3.3 SNOOZE mode in the RL78/G1F User's Manual.

- Note 11.** Current flowing only to the D/A converter. The supply current of the RL78 microcontrollers is the sum of IDD1 or IDD2 and IDAC when the D/A converter operates in an operation mode or the HALT mode.
- Note 12.** Current flowing only to the comparator circuit. The supply current of the RL78 microcontrollers is the sum of IDD1, IDD2, or IDD3 and ICMP when the comparator circuit is in operation.
- Remark 1.** f<sub>IL</sub>: Low-speed on-chip oscillator clock frequency
- Remark 2.** f<sub>SUB</sub>: Subsystem clock frequency (XT1 clock oscillation frequency)
- Remark 3.** f<sub>CLK</sub>: CPU/peripheral hardware clock frequency
- Remark 4.** Temperature condition of the TYP. value is TA = 25°C

## 2.4 AC Characteristics

(TA = -40 to +85°C, 1.6 V ≤ EVDD0 ≤ VDD ≤ 5.5 V, VSS = EVSS0 = 0 V)

Items	Symbol	Conditions		MIN.	TYP.	MAX.	Unit		
Instruction cycle (minimum instruction execution time)	Tcy	Main system clock (fMAIN) operation	HS (high-speed main) mode	2.7 V ≤ VDD ≤ 5.5 V	0.03125		1	μs	
				2.4 V ≤ VDD < 2.7 V	0.0625		1	μs	
			LS (low-speed main) mode	1.8 V ≤ VDD ≤ 5.5 V	0.125		1	μs	
			LV (low-voltage main) mode	1.6 V ≤ VDD ≤ 5.5 V	0.25		1	μs	
			Subsystem clock (fSUB) operation		1.8 V ≤ VDD ≤ 5.5 V	28.5	30.5	31.3	μs
			In the self-programming mode	HS (high-speed main) mode	2.7 V ≤ VDD ≤ 5.5 V	0.03125		1	μs
				2.4 V ≤ VDD < 2.7 V	0.0625		1	μs	
		LS (low-speed main) mode		1.8 V ≤ VDD ≤ 5.5 V	0.125		1	μs	
LV (low-voltage main) mode	1.8 V ≤ VDD ≤ 5.5 V	0.25			1	μs			
External system clock frequency	fex	2.7 V ≤ VDD ≤ 5.5 V			1.0		20.0	MHz	
		2.4 V ≤ VDD ≤ 2.7 V			1.0		16.0	MHz	
		1.8 V ≤ VDD < 2.4 V			1.0		8.0	MHz	
		1.6 V ≤ VDD < 1.8 V			1.0		4.0	MHz	
	fexs				32		35	kHz	
External system clock input high-level width, low-level width	texH, texL	2.7 V ≤ VDD ≤ 5.5 V			24			ns	
		2.4 V ≤ VDD ≤ 2.7 V			30			ns	
		1.8 V ≤ VDD < 2.4 V			60			ns	
		1.6 V ≤ VDD < 1.8 V			120			ns	
	texHS, texLS				13.7			μs	
Ti00 to Ti03 input high-level width, low-level width	ttrIH, ttrIL				1/fMCK + 10			ns	
Timer RJ input cycle	fc	TRJIO		2.7 V ≤ EVDD0 ≤ 5.5 V	100			ns	
				1.8 V ≤ EVDD0 < 2.7 V	300			ns	
				1.6 V ≤ EVDD0 < 1.8 V	500			ns	
Timer RJ input high-level width, low-level width	trJIH, trJIL	TRJIO		2.7 V ≤ EVDD0 ≤ 5.5 V	40			ns	
				1.8 V ≤ EVDD0 < 2.7 V	120			ns	
				1.6 V ≤ EVDD0 < 1.8 V	200			ns	

**Note** The following conditions are required for low voltage interface when EVDD0 < VDD

1.8 V ≤ EVDD0 < 2.7 V: MIN. 125 ns

1.6 V ≤ EVDD0 < 1.8 V: MIN. 250 ns

**Remark** fMCK: Timer array unit operation clock frequency

(Operation clock to be set by the CKSmn bit of timer mode register mn (TMRmn). m: Unit number (m = 0, 1), n: Channel number (n = 0 to 3))

(TA = -40 to +85°C, 1.6 V ≤ EVDD0 ≤ VDD ≤ 5.5 V, VSS = EVSS0 = 0 V)

(2/2)

Items	Symbol	Conditions		MIN.	TYP.	MAX.	Unit
Timer RD input high-level width, low-level width	tTDIH, tTDIL	TRDIOA0, TRDIOA1, TRDIOB0, TRDIOB1, TRDIOC0, TRDIOC1, TRDIOD0, TRDIOD1		3/fCLK			ns
Timer RD forced cutoff signal input low-level width	tTDSIL	P130/INTP0	2MHz < fCLK ≤ 32 MHz	1			μs
			fCLK ≤ 2 MHz	1/fCLK + 1			
Timer RG input high-level width, low-level width	tTGIH, tTGIL	TRGIOA, TRGIOB		2.5/fCLK			ns
TO00 to TO03, TRJIO0, TRJO0, TRDIOA0, TRDIOA1, TRDIOB0, TRDIOB1, TRDIOC0, TRDIOC1, TRDIOD0, TRDIOD1, TRGIOA, TRGIOB output frequency	fTO	HS (high-speed main) mode	4.0 V ≤ EVDD0 ≤ 5.5 V			16	MHz
			2.7 V ≤ EVDD0 < 4.0 V			8	MHz
			1.8 V ≤ EVDD0 < 2.7 V			4	MHz
			1.6 V ≤ EVDD0 < 1.8 V			2	MHz
		LS (low-speed main) mode	1.8 V ≤ EVDD0 ≤ 5.5 V			4	MHz
			1.6 V ≤ EVDD0 < 1.8 V			2	MHz
LV (low-voltage main) mode	1.6 V ≤ EVDD0 ≤ 5.5 V			2	MHz		
PCLBUZ0, PCLBUZ1 output frequency	fPCL	HS (high-speed main) mode	4.0 V ≤ EVDD0 ≤ 5.5 V			16	MHz
			2.7 V ≤ EVDD0 < 4.0 V			8	MHz
			1.8 V ≤ EVDD0 < 2.7 V			4	MHz
			1.6 V ≤ EVDD0 < 1.8 V			2	MHz
		LS (low-speed main) mode	1.8 V ≤ EVDD0 ≤ 5.5 V			4	MHz
			1.6 V ≤ EVDD0 < 1.8 V			2	MHz
		LV (low-voltage main) mode	1.8 V ≤ EVDD0 ≤ 5.5 V			4	MHz
			1.6 V ≤ EVDD0 < 1.8 V			2	MHz
Interrupt input high-level width, low-level width	tINTH, tINTL	INTP0	1.6 V ≤ VDD ≤ 5.5 V	1			μs
		INTP1 to INTP11	1.6 V ≤ EVDD0 ≤ 5.5 V	1			μs
Key interrupt input low-level width	tKR	KR0 to KR7	1.8 V ≤ EVDD0 ≤ 5.5 V	250			ns
			1.6 V ≤ EVDD0 < 1.8 V	1			μs
RESET low-level width	tRSL			10			μs

Minimum Instruction Execution Time during Main System Clock Operation

T<sub>CY</sub> vs V<sub>DD</sub> (HS (high-speed main) mode)

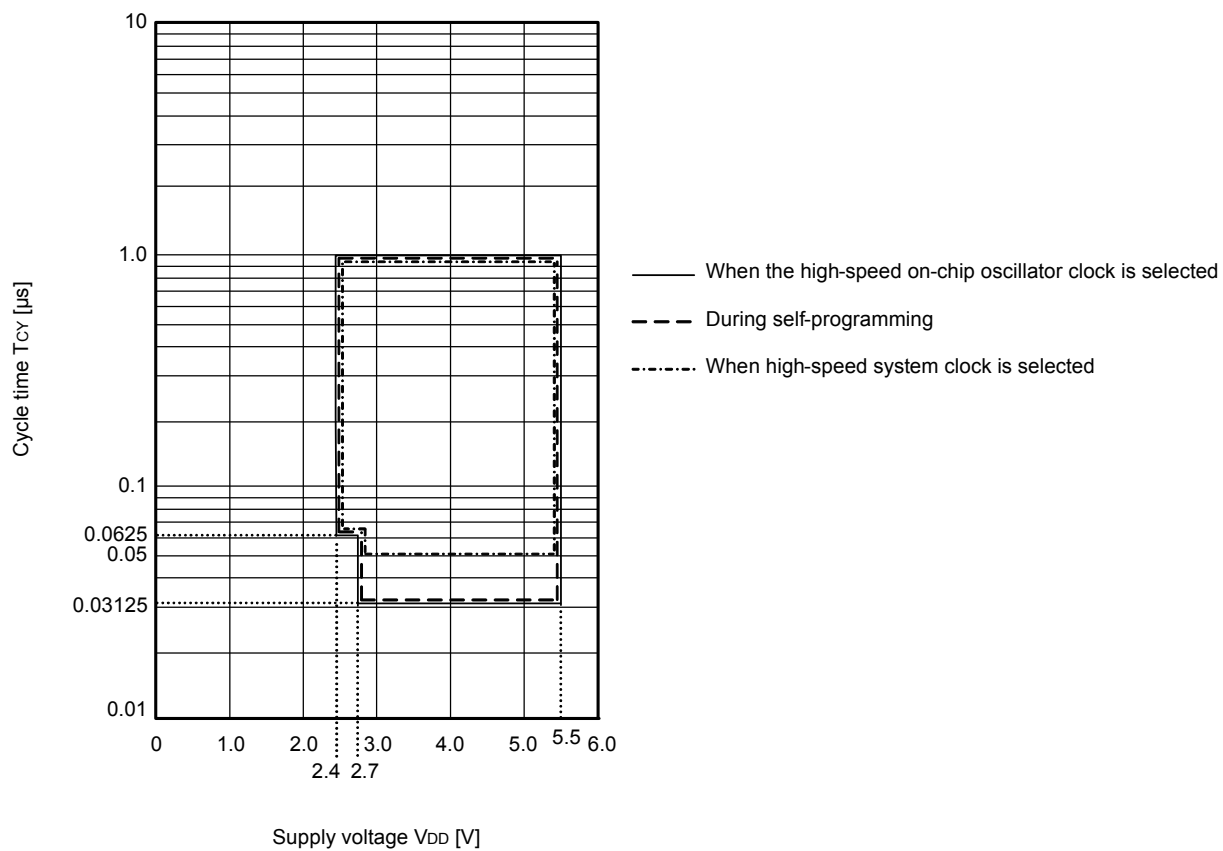

T<sub>CY</sub> vs V<sub>DD</sub> (LS (low-speed main) mode)

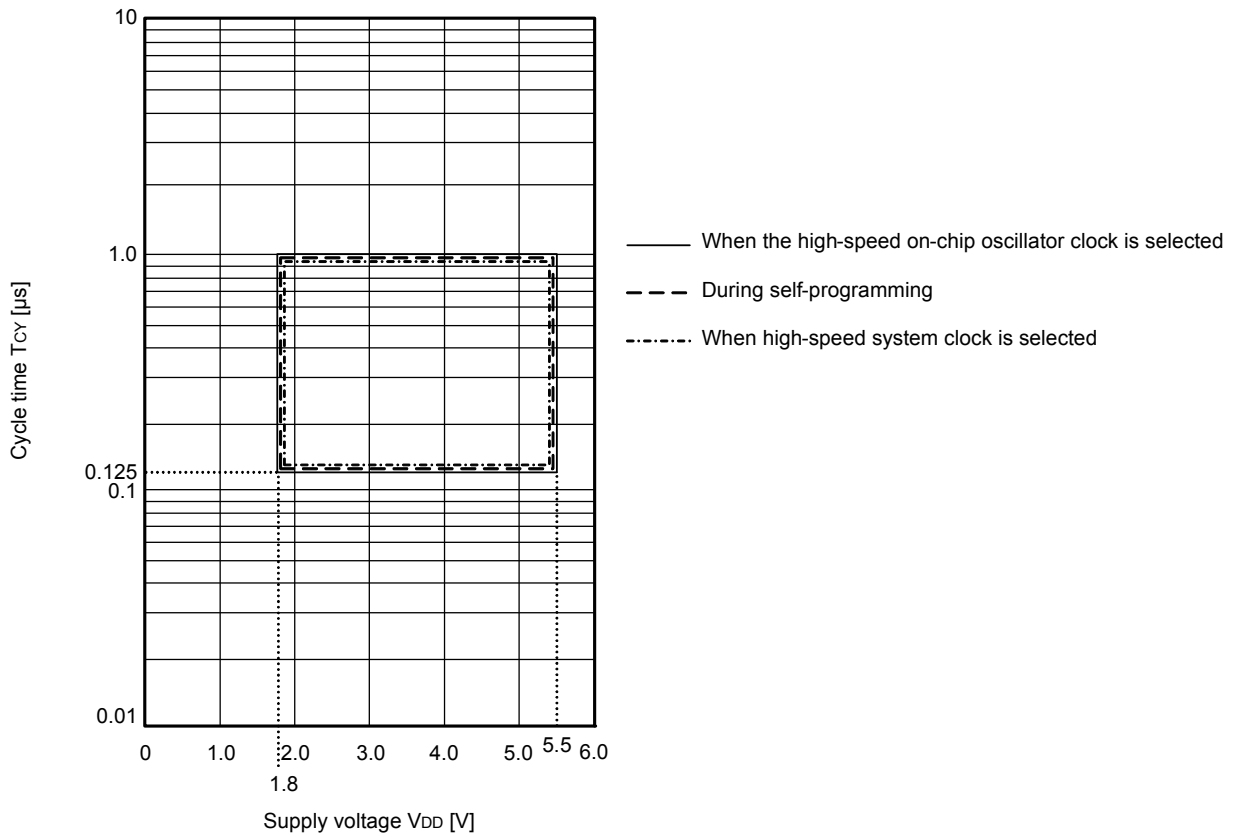

T<sub>CY</sub> vs V<sub>DD</sub> (LV (low-voltage main) mode)

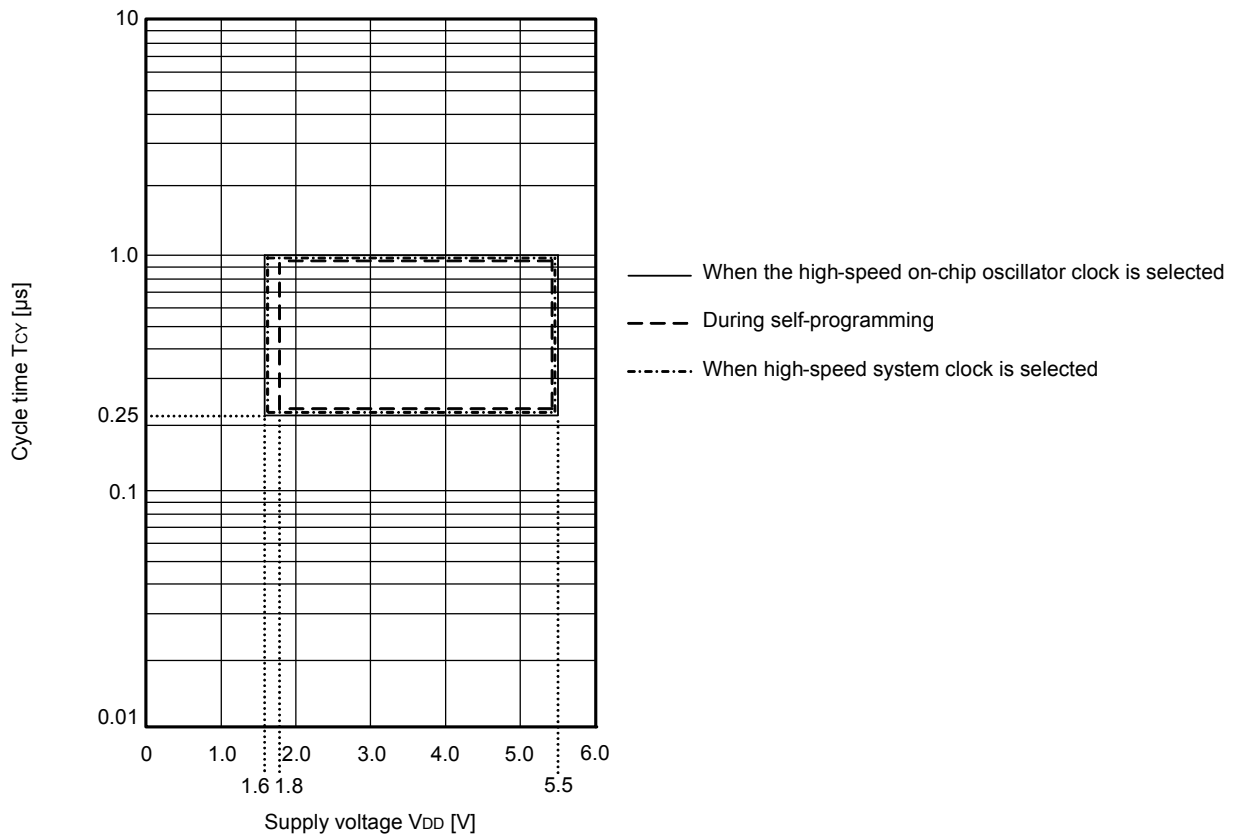



AC Timing Test Points

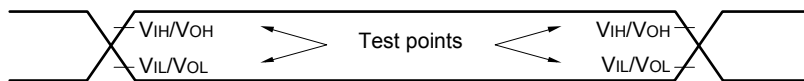

External System Clock Timing

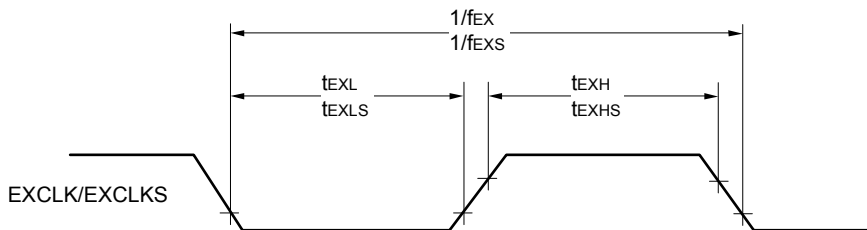

TI/TO Timing

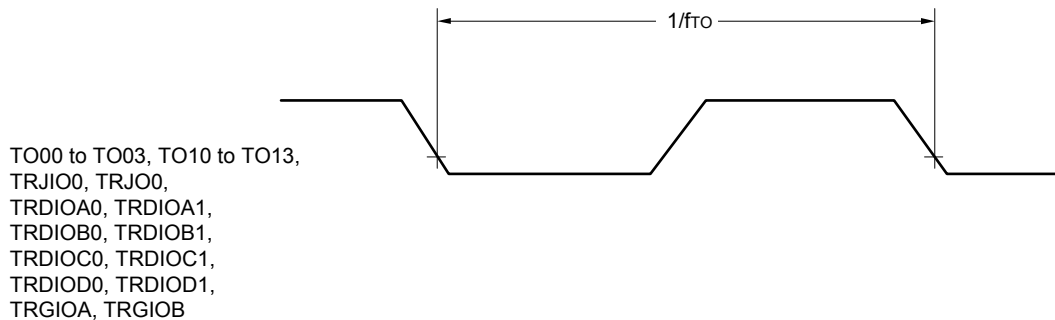
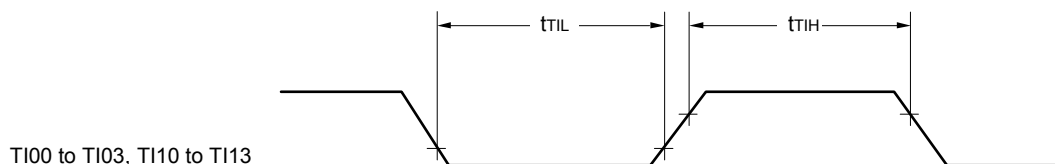

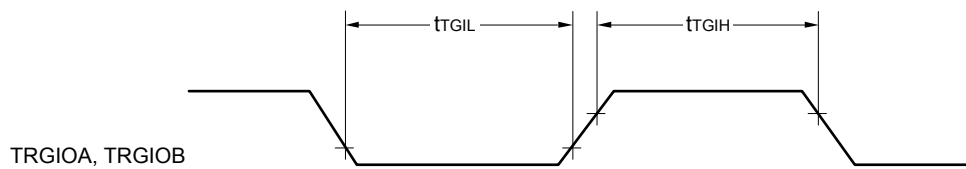
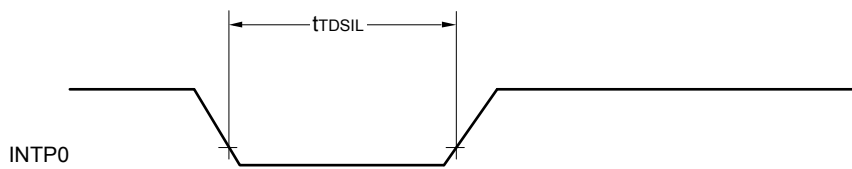
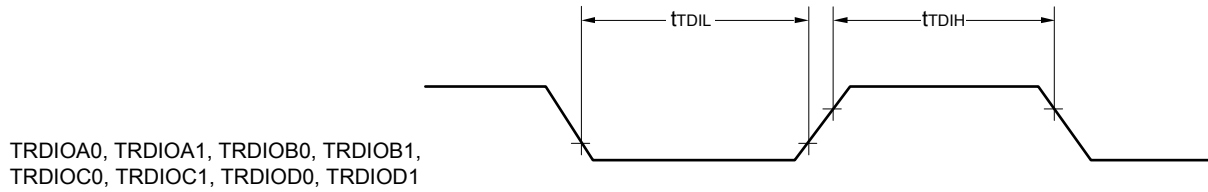
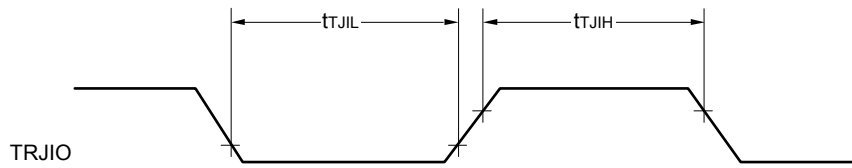

Interrupt Request Input Timing

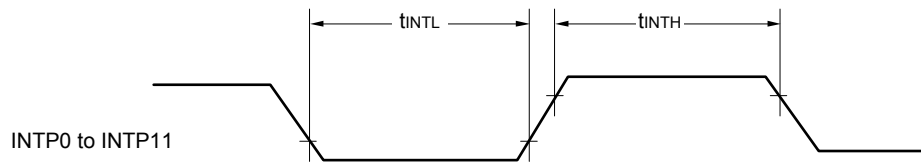

Key Interrupt Input Timing

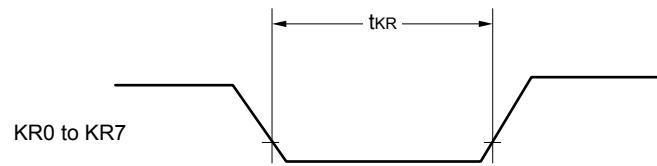

$\overline{\text{RESET}}$  Input Timing

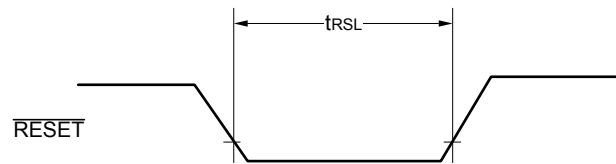

## 2.5 Peripheral Functions Characteristics

AC Timing Test Points

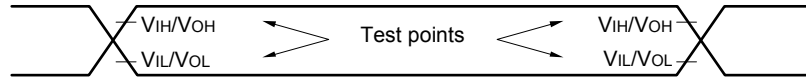

### 2.5.1 Serial array unit

(1) During communication at same potential (UART mode)

(TA = -40 to +85°C, 1.6 V ≤ EVDD0 ≤ 5.5 V, VSS = EVSS0 = 0 V)

Parameter	Symbol	Conditions	HS (high-speed main) Mode		LS (low-speed main) Mode		LV (low-voltage main) Mode		Unit
			MIN.	MAX.	MIN.	MAX.	MIN.	MAX.	
Transfer rate Note 1		2.4 V ≤ EVDD0 ≤ 5.5 V		fMCK/6 Note 2		fMCK/6		fMCK/6	bps
		Theoretical value of the maximum transfer rate fMCK = fCLK Note 3		5.3		1.3		0.6	Mbps
		1.8 V ≤ EVDD0 ≤ 5.5 V		fMCK/6 Note 2		fMCK/6		fMCK/6	bps
		Theoretical value of the maximum transfer rate fMCK = fCLK Note 3		5.3		1.3		0.6	Mbps
		1.7 V ≤ EVDD0 ≤ 5.5 V		fMCK/6 Note 2		fMCK/6 Note 2		fMCK/6	bps
		Theoretical value of the maximum transfer rate fMCK = fCLK Note 3		5.3		1.3		0.6	Mbps
		1.6 V ≤ EVDD0 ≤ 5.5 V		—		fMCK/6 Note 2		fMCK/6	bps
		Theoretical value of the maximum transfer rate fMCK = fCLK Note 3		—		1.3		0.6	Mbps

**Note 1.** Transfer rate in the SNOOZE mode is 4800 bps only.

However, the SNOOZE mode cannot be used when FRQSEL4 = 1.

**Note 2.** The following conditions are required for low voltage interface when EVDD0 < VDD.

2.4 V ≤ EVDD0 < 2.7 V: MAX. 2.6 Mbps

1.8 V ≤ EVDD0 < 2.4 V: MAX. 1.3 Mbps

1.6 V ≤ EVDD0 < 1.8 V: MAX. 0.6 Mbps

**Note 3.** The maximum operating frequencies of the CPU/peripheral hardware clock (fCLK) are:

HS (high-speed main) mode: 32 MHz (2.7 V ≤ VDD ≤ 5.5 V)

16 MHz (2.4 V ≤ VDD ≤ 5.5 V)

LS (low-speed main) mode: 8 MHz (1.8 V ≤ VDD ≤ 5.5 V)

LV (low-voltage main) mode: 4 MHz (1.6 V ≤ VDD ≤ 5.5 V)

**Caution** Select the normal input buffer for the RxDq pin and the normal output mode for the TxDq pin by using port input mode register g (PIMg) and port output mode register g (POMg).

**UART mode connection diagram (during communication at same potential)**

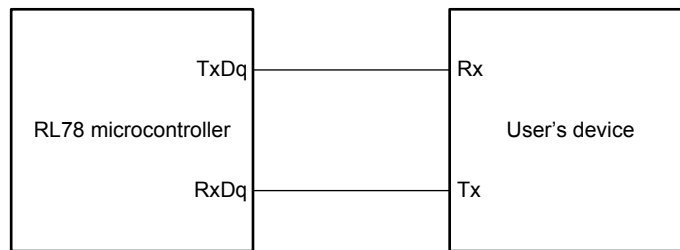

**UART mode bit width (during communication at same potential) (reference)**

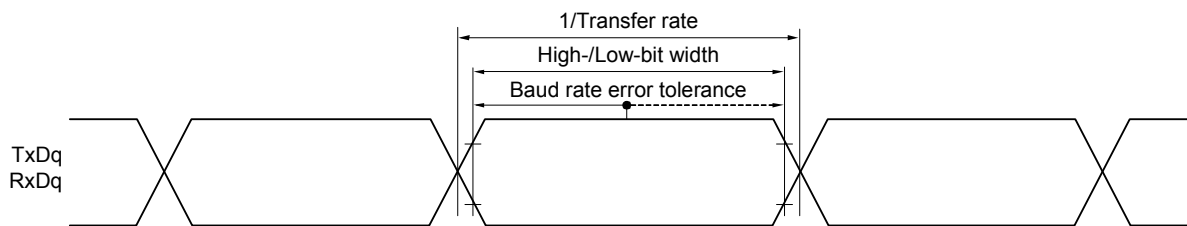

**Remark 1.** q: UART number (q = 0 to 2), g: PIM and POM number (g = 0, 1, 3, 5, 7)

**Remark 2.** f<sub>MCK</sub>: Serial array unit operation clock frequency

(Operation clock to be set by the CKSmn bit of serial mode register mn (SMRmn). m: Unit number, n: Channel number (mn = 00 to 03, 10, 11))

**(2) During communication at same potential (CSI mode) (master mode, SCKp... internal clock output, corresponding CSI00 only)****(TA = -40 to +85°C, 2.7 V ≤ EVDD0 ≤ VDD ≤ 5.5 V, VSS = EVSS0 = 0 V)**

Parameter	Symbol	Conditions	HS (high-speed main) mode		LS (low-speed main) mode		LV (low-voltage main) mode		Unit
			MIN.	MAX.	MIN.	MAX.	MIN.	MAX.	
SCKp cycle time	tkCY1	tkCY1 ≥ 2/fCLK 4.0 V ≤ EVDD0 ≤ 5.5 V	62.5		250		500		ns
			83.3		250		500		ns
SCKp high-/low-level width	tkH1, tkL1	4.0 V ≤ EVDD0 ≤ 5.5 V	tkCY1/2 - 7		tkCY1/2 - 50		tkCY1/2 - 50		ns
		2.7 V ≤ EVDD0 ≤ 5.5 V	tkCY1/2 - 10		tkCY1/2 - 50		tkCY1/2 - 50		ns
Slp setup time (to SCKp↑) Note 1	tsIK1	4.0 V ≤ EVDD0 ≤ 5.5 V	23		110		110		ns
		2.7 V ≤ EVDD0 ≤ 5.5 V	33		110		110		ns
Slp hold time (from SCKp↑) Note 2	tsIH1	2.7 V ≤ EVDD0 ≤ 5.5 V	10		10		10		ns
Delay time from SCKp↓ to SOp output Note 3	tkSO1	C = 20 pF Note 4		10		10		10	ns

**Note 1.** When DAPmn = 0 and CKPmn = 0, or DAPmn = 1 and CKPmn = 1. The Slp setup time becomes “to SCKp↓” when DAPmn = 0 and CKPmn = 1, or DAPmn = 1 and CKPmn = 0.

**Note 2.** When DAPmn = 0 and CKPmn = 0, or DAPmn = 1 and CKPmn = 1. The Slp hold time becomes “from SCKp↓” when DAPmn = 0 and CKPmn = 1, or DAPmn = 1 and CKPmn = 0.

**Note 3.** When DAPmn = 0 and CKPmn = 0, or DAPmn = 1 and CKPmn = 1. The delay time to SOp output becomes “from SCKp↑” when DAPmn = 0 and CKPmn = 1, or DAPmn = 1 and CKPmn = 0.

**Note 4.** C is the load capacitance of the SCKp and SOp output lines.

**Caution** Select the normal input buffer for the Slp pin and the normal output mode for the SOp pin and SCKp pin by using port input mode register g (PIMg) and port output mode register g (POMg).

**Remark 1.** This value is valid only when CSI00's peripheral I/O redirect function is not used.

**Remark 2.** p: CSI number (p = 00), m: Unit number (m = 0), n: Channel number (n = 0),  
g: PIM and POM numbers (g = 1)

**Remark 3.** fMCK: Serial array unit operation clock frequency  
(Operation clock to be set by the CKSmn bit of serial mode register mn (SMRmn). m: Unit number,  
n: Channel number (mn = 00))

**(3) During communication at same potential (CSI mode) (master mode, SCKp... internal clock output)**  
**(TA = -40 to +85°C, 1.6 V ≤ EVDD0 ≤ VDD ≤ 5.5 V, VSS = EVSS0 = 0 V)**

Parameter	Symbol	Conditions	HS (high-speed main) mode		LS (low-speed main) mode		LV (low-voltage main) mode		Unit
			MIN.	MAX.	MIN.	MAX.	MIN.	MAX.	
SCKp cycle time	tkCY1	tkCY1 ≥ 4/fCLK	2.7 V ≤ EVDD0 ≤ 5.5 V	125		500		1000	ns
			2.4 V ≤ EVDD0 ≤ 5.5 V	250		500		1000	ns
			1.8 V ≤ EVDD0 ≤ 5.5 V	500		500		1000	ns
			1.7 V ≤ EVDD0 ≤ 5.5 V	1000		1000		1000	ns
			1.6 V ≤ EVDD0 ≤ 5.5 V	—		1000		1000	ns
SCKp high-/low-level width	tkH1, tkL1	4.0 V ≤ EVDD0 ≤ 5.5 V	tkCY1/2 - 12		tkCY1/2 - 50		tkCY1/2 - 50	ns	
		2.7 V ≤ EVDD0 ≤ 5.5 V	tkCY1/2 - 18		tkCY1/2 - 50		tkCY1/2 - 50	ns	
		2.4 V ≤ EVDD0 ≤ 5.5 V	tkCY1/2 - 38		tkCY1/2 - 50		tkCY1/2 - 50	ns	
		1.8 V ≤ EVDD0 ≤ 5.5 V	tkCY1/2 - 50		tkCY1/2 - 50		tkCY1/2 - 50	ns	
		1.7 V ≤ EVDD0 ≤ 5.5 V	tkCY1/2 - 100		tkCY1/2 - 100		tkCY1/2 - 100	ns	
		1.6 V ≤ EVDD0 ≤ 5.5 V	—		tkCY1/2 - 100		tkCY1/2 - 100	ns	
Slp setup time (to SCKp↑) Note 1	tSIK1	4.0 V ≤ EVDD0 ≤ 5.5 V	44		110		110	ns	
		2.7 V ≤ EVDD0 ≤ 5.5 V	44		110		110	ns	
		2.4 V ≤ EVDD0 ≤ 5.5 V	75		110		110	ns	
		1.8 V ≤ EVDD0 ≤ 5.5 V	110		110		110	ns	
		1.7 V ≤ EVDD0 ≤ 5.5 V	220		220		220	ns	
		1.6 V ≤ EVDD0 ≤ 5.5 V	—		220		220	ns	
Slp hold time (from SCKp↑) Note 2	tkSI1	1.7 V ≤ EVDD0 ≤ 5.5 V	19		19		19	ns	
		1.6 V ≤ EVDD0 ≤ 5.5 V	—		19		19	ns	
Delay time from SCKp↓ to SOp output Note 3	tkSO1	1.7 V ≤ EVDD0 ≤ 5.5 V C = 30 pF Note 4		25		25	25	ns	
		1.6 V ≤ EVDD0 ≤ 5.5 V C = 30 pF Note 4		—		25	25	ns	

**Note 1.** When DAPmn = 0 and CKPmn = 0, or DAPmn = 1 and CKPmn = 1. The Slp setup time becomes “to SCKp↓” when DAPmn = 0 and CKPmn = 1, or DAPmn = 1 and CKPmn = 0.

**Note 2.** When DAPmn = 0 and CKPmn = 0, or DAPmn = 1 and CKPmn = 1. The Slp hold time becomes “from SCKp↓” when DAPmn = 0 and CKPmn = 1, or DAPmn = 1 and CKPmn = 0.

**Note 3.** When DAPmn = 0 and CKPmn = 0, or DAPmn = 1 and CKPmn = 1. The delay time to SOp output becomes “from SCKp↑” when DAPmn = 0 and CKPmn = 1, or DAPmn = 1 and CKPmn = 0.

**Note 4.** C is the load capacitance of the SCKp and SOp output lines.

**Caution** Select the normal input buffer for the Slp pin and the normal output mode for the SOp pin and SCKp pin by using port input mode register g (PIMg) and port output mode register g (POMg).

**Remark 1.** p: CSI number (p = 00, 01, 10, 11, 20, 21), m: Unit number (m = 0, 1), n: Channel number (n = 0 to 3), g: PIM number (g = 0, 1, 3, 5, 7)

**Remark 2.** fMCK: Serial array unit operation clock frequency  
 (Operation clock to be set by the CKSmn bit of serial mode register mn (SMRmn). m: Unit number, n: Channel number (mn = 00 to 03, 10, 11))

**(4) During communication at same potential (CSI mode) (slave mode, SCKp... external clock input)****(TA = -40 to +85°C, 1.6 V ≤ EVDD0 ≤ VDD ≤ 5.5 V, VSS = EVSS0 = 0 V)**

Parameter	Symbol	Conditions		HS (high-speed main) mode		LS (low-speed main) mode		LV (low-voltage main) mode		Unit	
				MIN.	MAX.	MIN.	MAX.	MIN.	MAX.		
SCKp cycle time <small>Note 5</small>	tkCY2	4.0 V ≤ EVDD0 ≤ 5.5 V	20 MHz < fMCK	8/fMCK		—		—		ns	
			fMCK ≤ 20 MHz	6/fMCK		6/fMCK		6/fMCK		ns	
		2.7 V ≤ EVDD0 ≤ 5.5 V	16 MHz < fMCK	8/fMCK		—		—		ns	
			fMCK ≤ 16 MHz	6/fMCK		6/fMCK		6/fMCK		ns	
		2.4 V ≤ EVDD0 ≤ 5.5 V			6/fMCK and 500		6/fMCK and 500		6/fMCK and 500		ns
		1.8 V ≤ EVDD0 ≤ 5.5 V			6/fMCK and 750		6/fMCK and 750		6/fMCK and 750		ns
		1.7 V ≤ EVDD0 ≤ 5.5 V			6/fMCK and 1500		6/fMCK and 1500		6/fMCK and 1500		ns
		1.6 V ≤ EVDD0 ≤ 5.5 V			—		6/fMCK and 1500		6/fMCK and 1500		ns
SCKp high-/low-level width	tkH2, tkL2	4.0 V ≤ EVDD0 ≤ 5.5 V		tkCY2/2 - 7		tkCY2/2 - 7		tkCY2/2 - 7		ns	
		2.7 V ≤ EVDD0 ≤ 5.5 V		tkCY2/2 - 8		tkCY2/2 - 8		tkCY2/2 - 8		ns	
		1.8 V ≤ EVDD0 ≤ 5.5 V		tkCY2/2 - 18		tkCY2/2 - 18		tkCY2/2 - 18		ns	
		1.7 V ≤ EVDD0 ≤ 5.5 V		tkCY2/2 - 66		tkCY2/2 - 66		tkCY2/2 - 66		ns	
		1.6 V ≤ EVDD0 ≤ 5.5 V		—		tkCY2/2 - 66		tkCY2/2 - 66		ns	
Slp setup time (to SCKp↑) <small>Note 1</small>	tsIK2	2.7 V ≤ EVDD0 ≤ 5.5 V		1/fMCK + 20		1/fMCK + 30		1/fMCK + 30		ns	
		1.8 V ≤ EVDD0 ≤ 5.5 V		1/fMCK + 30		1/fMCK + 30		1/fMCK + 30		ns	
		1.7 V ≤ EVDD0 ≤ 5.5 V		1/fMCK + 40		1/fMCK + 40		1/fMCK + 40		ns	
		1.6 V ≤ EVDD0 ≤ 5.5 V		—		1/fMCK + 40		1/fMCK + 40		ns	
Slp hold time (from SCKp↑) <small>Note 2</small>	tkSI2	1.8 V ≤ EVDD0 ≤ 5.5 V		1/fMCK + 31		1/fMCK + 31		1/fMCK + 31		ns	
		1.7 V ≤ EVDD0 ≤ 5.5 V		1/fMCK + 250		1/fMCK + 250		1/fMCK + 250		ns	
		1.6 V ≤ EVDD0 ≤ 5.5 V		—		1/fMCK + 250		1/fMCK + 250		ns	
Delay time from SCKp↓ to SOp output <small>Note 3</small>	tkSO2	C = 30 pF <small>Note 4</small>	2.7 V ≤ EVDD0 ≤ 5.5 V		2/fMCK + 44		2/fMCK + 110		2/fMCK + 110	ns	
			2.4 V ≤ EVDD0 ≤ 5.5 V		2/fMCK + 75		2/fMCK + 110		2/fMCK + 110	ns	
			1.8 V ≤ EVDD0 ≤ 5.5 V		2/fMCK + 100		2/fMCK + 110		2/fMCK + 110	ns	
			1.7 V ≤ EVDD0 ≤ 5.5 V		2/fMCK + 220		2/fMCK + 220		2/fMCK + 220	ns	
			1.6 V ≤ EVDD0 ≤ 5.5 V		—		2/fMCK + 220		2/fMCK + 220	ns	

**Note 1.** When DAPmn = 0 and CKPmn = 0, or DAPmn = 1 and CKPmn = 1. The Slp setup time becomes “to SCKp↓” when DAPmn = 0 and CKPmn = 1, or DAPmn = 1 and CKPmn = 0.

**Note 2.** When DAPmn = 0 and CKPmn = 0, or DAPmn = 1 and CKPmn = 1. The Slp hold time becomes “from SCKp↓” when DAPmn = 0 and CKPmn = 1, or DAPmn = 1 and CKPmn = 0.

**Note 3.** When DAPmn = 0 and CKPmn = 0, or DAPmn = 1 and CKPmn = 1. The delay time to SOp output becomes “from SCKp↑” when DAPmn = 0 and CKPmn = 1, or DAPmn = 1 and CKPmn = 0.

**Note 4.** C is the load capacitance of the SOp output lines.

**Note 5.** The maximum transfer rate when using the SNOOZE mode is 1 Mbps.

**Caution** Select the normal input buffer for the Slp pin and SCKp pin and the normal output mode for the SOp pin by using port input mode register g (PIMg) and port output mode register g (POMg).



**Remark 1.** p: CSI number (p = 00, 01, 10, 11, 20, 21), m: Unit number (m = 0, 1),  
n: Channel number (n = 0 to 3), g: PIM number (g = 0, 1, 3, 5, 7)

**Remark 2.** f<sub>MCK</sub>: Serial array unit operation clock frequency  
(Operation clock to be set by the CKSmn bit of serial mode register mn (SMRmn). m: Unit number,  
n: Channel number (mn = 00 to 03, 10, 11))

**(4) During communication at same potential (CSI mode) (slave mode, SCKp... external clock input)**

**(TA = -40 to +85°C, 1.6 V ≤ EVDD0 ≤ VDD ≤ 5.5 V, VSS = EVSS0 = 0 V)**

**(2/2)**

Parameter	Symbol	Conditions	HS (high-speed main) mode		LS (low-speed main) mode		LV (low-voltage main) mode		Unit	
			MIN.	MAX.	MIN.	MAX.	MIN.	MAX.		
SSI00 setup time	tSSIK	DAPmn = 0	2.7 V ≤ EVDD0 ≤ 5.5 V	120		120		120		ns
			1.8 V ≤ EVDD0 ≤ 5.5 V	200		200		200		ns
			1.7 V ≤ EVDD0 ≤ 5.5 V	400		400		400		ns
			1.6 V ≤ EVDD0 ≤ 5.5 V	—		400		400		ns
		DAPmn = 1	2.7 V ≤ EVDD0 ≤ 5.5 V	1/fMCK + 120		1/fMCK + 120		1/fMCK + 120		ns
			1.8 V ≤ EVDD0 ≤ 5.5 V	1/fMCK + 200		1/fMCK + 200		1/fMCK + 200		ns
			1.7 V ≤ EVDD0 ≤ 5.5 V	1/fMCK + 400		1/fMCK + 400		1/fMCK + 400		ns
			1.6 V ≤ EVDD0 ≤ 5.5 V	—		1/fMCK + 400		1/fMCK + 400		ns
SSI00 hold time	tkSSI	DAPmn = 0	2.7 V ≤ EVDD0 ≤ 5.5 V	1/fMCK + 120		1/fMCK + 120		1/fMCK + 120		ns
			1.8 V ≤ EVDD0 ≤ 5.5 V	1/fMCK + 200		1/fMCK + 200		1/fMCK + 200		ns
			1.7 V ≤ EVDD0 ≤ 5.5 V	1/fMCK + 400		1/fMCK + 400		1/fMCK + 400		ns
			1.6 V ≤ EVDD0 ≤ 5.5 V	—		1/fMCK + 400		1/fMCK + 400		ns
		DAPmn = 1	2.7 V ≤ EVDD0 ≤ 5.5 V	120		120		120		ns
			1.8 V ≤ EVDD0 ≤ 5.5 V	200		200		200		ns
			1.7 V ≤ EVDD0 ≤ 5.5 V	400		400		400		ns
			1.6 V ≤ EVDD0 ≤ 5.5 V	—		400		400		ns

**Caution** Select the normal input buffer for the Slp pin and SCKp pin and the normal output mode for the SOp pin by using port input mode register g (PIMg) and port output mode register g (POMg).

**Remark** p: CSI number (p = 00), m: Unit number (m = 0), n: Channel number (n = 0), g: PIM number (g = 3, 5)

**CSI mode connection diagram (during communication at same potential)**

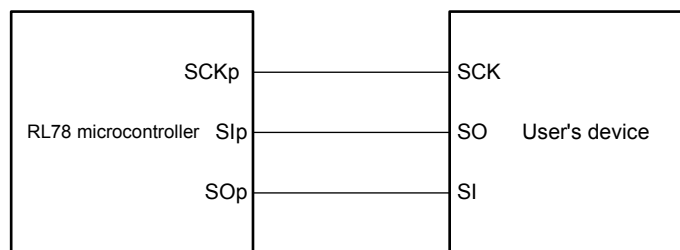

**CSI mode connection diagram (during communication at same potential)  
(Slave Transmission of slave select input function (CSI00))**

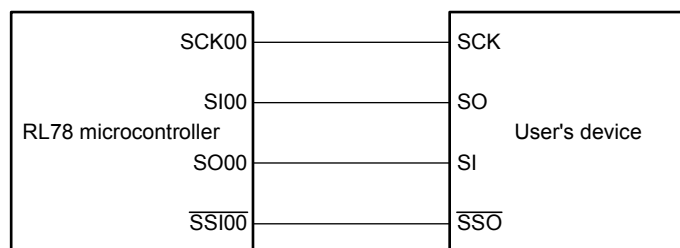

**Remark 1.** p: CSI number (p = 00, 01, 10, 11, 20, 21)

**Remark 2.** m: Unit number, n: Channel number (mn = 00 to 03, 10, 11)

**CSI mode serial transfer timing (during communication at same potential)**  
**(When DAPmn = 0 and CKPmn = 0, or DAPmn = 1 and CKPmn = 1.)**

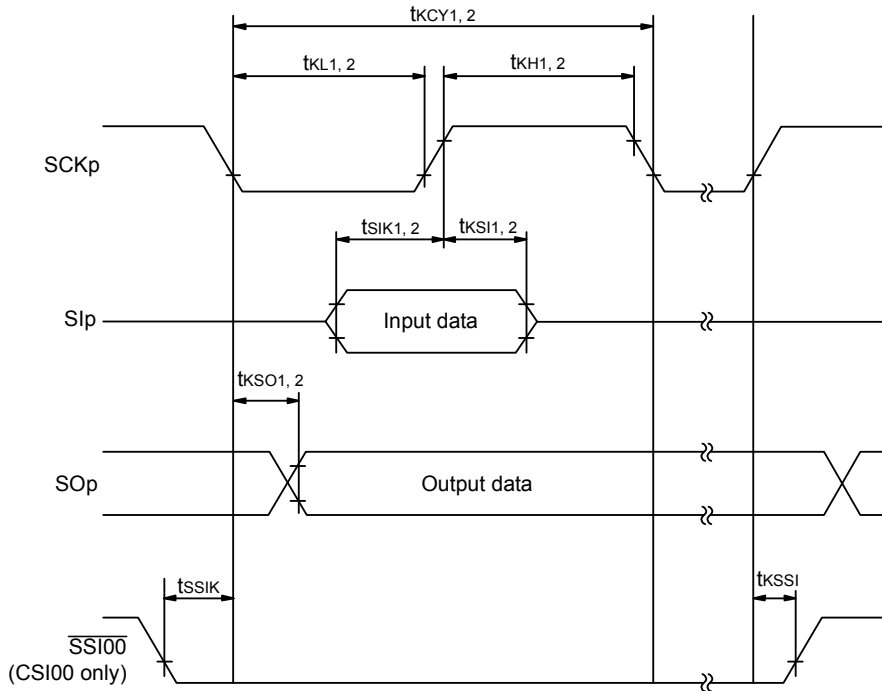

**CSI mode serial transfer timing (during communication at same potential)**  
**(When DAPmn = 0 and CKPmn = 1, or DAPmn = 1 and CKPmn = 0.)**

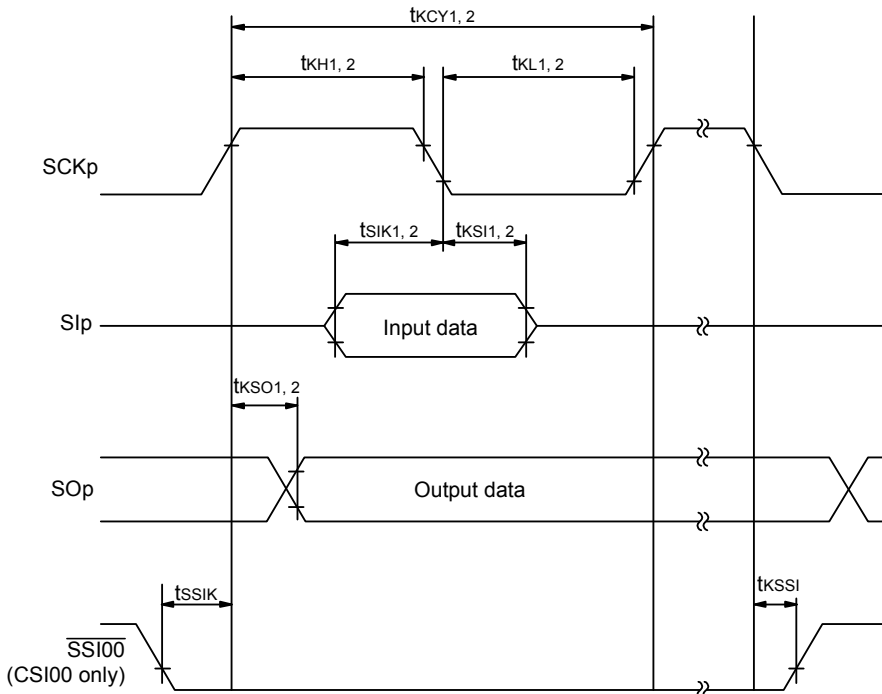

**Remark 1.** p: CSI number (p = 00, 01, 10, 11, 20, 21)

**Remark 2.** m: Unit number, n: Channel number (mn = 00 to 03, 10, 11)

**(5) During communication at same potential (simplified I<sup>2</sup>C mode)****(TA = -40 to +85°C, 1.6 V ≤ EV<sub>DD0</sub> ≤ V<sub>DD</sub> ≤ 5.5 V, V<sub>SS</sub> = EV<sub>SS0</sub> = 0 V)****(1/2)**

Parameter	Symbol	Conditions	HS (high-speed main) mode		LS (low-speed main) mode		LV (low-voltage main) mode		Unit
			MIN.	MAX.	MIN.	MAX.	MIN.	MAX.	
SCLr clock frequency	f <sub>SCL</sub>	2.7 V ≤ EV <sub>DD0</sub> ≤ 5.5 V, C <sub>b</sub> = 50 pF, R <sub>b</sub> = 2.7 kΩ		1000 Note 1		400 Note 1		400 Note 1	kHz
		1.8 V ≤ EV <sub>DD0</sub> ≤ 5.5 V, C <sub>b</sub> = 100 pF, R <sub>b</sub> = 3 kΩ		400 Note 1		400 Note 1		400 Note 1	kHz
		1.8 V ≤ EV <sub>DD0</sub> < 2.7 V, C <sub>b</sub> = 100 pF, R <sub>b</sub> = 5 kΩ		300 Note 1		300 Note 1		300 Note 1	kHz
		1.7 V ≤ EV <sub>DD0</sub> < 1.8 V, C <sub>b</sub> = 100 pF, R <sub>b</sub> = 5 kΩ		250 Note 1		250 Note 1		250 Note 1	kHz
		1.6 V ≤ EV <sub>DD0</sub> < 1.8 V, C <sub>b</sub> = 100 pF, R <sub>b</sub> = 5 kΩ		—		250 Note 1		250 Note 1	kHz
Hold time when SCLr = "L"	t <sub>LOW</sub>	2.7 V ≤ EV <sub>DD0</sub> ≤ 5.5 V, C <sub>b</sub> = 50 pF, R <sub>b</sub> = 2.7 kΩ	475		1150		1150		ns
		1.8 V ≤ EV <sub>DD0</sub> ≤ 5.5 V, C <sub>b</sub> = 100 pF, R <sub>b</sub> = 3 kΩ	1150		1150		1150		ns
		1.8 V ≤ EV <sub>DD0</sub> < 2.7 V, C <sub>b</sub> = 100 pF, R <sub>b</sub> = 5 kΩ	1550		1550		1550		ns
		1.7 V ≤ EV <sub>DD0</sub> < 1.8 V, C <sub>b</sub> = 100 pF, R <sub>b</sub> = 5 kΩ	1850		1850		1850		ns
		1.6 V ≤ EV <sub>DD0</sub> < 1.8 V, C <sub>b</sub> = 100 pF, R <sub>b</sub> = 5 kΩ	—		1850		1850		ns
Hold time when SCLr = "H"	t <sub>HIGH</sub>	2.7 V ≤ EV <sub>DD0</sub> ≤ 5.5 V, C <sub>b</sub> = 50 pF, R <sub>b</sub> = 2.7 kΩ	475		1150		1150		ns
		1.8 V ≤ EV <sub>DD0</sub> ≤ 5.5 V, C <sub>b</sub> = 100 pF, R <sub>b</sub> = 3 kΩ	1150		1150		1150		ns
		1.8 V ≤ EV <sub>DD0</sub> < 2.7 V, C <sub>b</sub> = 100 pF, R <sub>b</sub> = 5 kΩ	1550		1550		1550		ns
		1.7 V ≤ EV <sub>DD0</sub> < 1.8 V, C <sub>b</sub> = 100 pF, R <sub>b</sub> = 5 kΩ	1850		1850		1850		ns
		1.6 V ≤ EV <sub>DD0</sub> < 1.8 V, C <sub>b</sub> = 100 pF, R <sub>b</sub> = 5 kΩ	—		1850		1850		ns

(Notes and Caution are listed on the next page, and Remarks are listed on the page after the next page.)

**(5) During communication at same potential (simplified I<sup>2</sup>C mode)****(TA = -40 to +85°C, 1.6 V ≤ EV<sub>DD0</sub> ≤ V<sub>DD</sub> ≤ 5.5 V, V<sub>SS</sub> = EV<sub>SS0</sub> = 0 V)****(2/2)**

Parameter	Symbol	Conditions	HS (high-speed main) mode		LS (low-speed main) mode		LV (low-voltage main) mode		Unit
			MIN.	MAX.	MIN.	MAX.	MIN.	MAX.	
Data setup time (reception)	tsu: DAT	2.7 V ≤ EV <sub>DD0</sub> ≤ 5.5 V, C <sub>b</sub> = 50 pF, R <sub>b</sub> = 2.7 kΩ	1/f <sub>MCK</sub> + 85 Note 2		1/f <sub>MCK</sub> + 145 Note 2		1/f <sub>MCK</sub> + 145 Note 2		ns
		1.8 V ≤ EV <sub>DD0</sub> ≤ 5.5 V, C <sub>b</sub> = 100 pF, R <sub>b</sub> = 3 kΩ	1/f <sub>MCK</sub> + 145 Note 2		1/f <sub>MCK</sub> + 145 Note 2		1/f <sub>MCK</sub> + 145 Note 2		ns
		1.8 V ≤ EV <sub>DD0</sub> < 2.7 V, C <sub>b</sub> = 100 pF, R <sub>b</sub> = 5 kΩ	1/f <sub>MCK</sub> + 230 Note 2		1/f <sub>MCK</sub> + 230 Note 2		1/f <sub>MCK</sub> + 230 Note 2		ns
		1.7 V ≤ EV <sub>DD0</sub> < 1.8 V, C <sub>b</sub> = 100 pF, R <sub>b</sub> = 5 kΩ	1/f <sub>MCK</sub> + 290 Note 2		1/f <sub>MCK</sub> + 290 Note 2		1/f <sub>MCK</sub> + 290 Note 2		ns
		1.6 V ≤ EV <sub>DD0</sub> < 1.8 V, C <sub>b</sub> = 100 pF, R <sub>b</sub> = 5 kΩ	—		1/f <sub>MCK</sub> + 290 Note 2		1/f <sub>MCK</sub> + 290 Note 2		ns
Data hold time (transmission)	thd: DAT	2.7 V ≤ EV <sub>DD0</sub> ≤ 5.5 V, C <sub>b</sub> = 50 pF, R <sub>b</sub> = 2.7 kΩ	0	305	0	305	0	305	ns
		1.8 V ≤ EV <sub>DD0</sub> ≤ 5.5 V, C <sub>b</sub> = 100 pF, R <sub>b</sub> = 3 kΩ	0	355	0	355	0	355	ns
		1.8 V ≤ EV <sub>DD0</sub> < 2.7 V, C <sub>b</sub> = 100 pF, R <sub>b</sub> = 5 kΩ	0	405	0	405	0	405	ns
		1.7 V ≤ EV <sub>DD0</sub> < 1.8 V, C <sub>b</sub> = 100 pF, R <sub>b</sub> = 5 kΩ	0	405	0	405	0	405	ns
		1.6 V ≤ EV <sub>DD0</sub> < 1.8 V, C <sub>b</sub> = 100 pF, R <sub>b</sub> = 5 kΩ	—		0	405	0	405	ns

**Note 1.** The value must also be equal to or less than f<sub>MCK</sub>/4.

**Note 2.** Set the f<sub>MCK</sub> value to keep the hold time of SCLr = "L" and SCLr = "H".

**Caution** Select the normal input buffer and the N-ch open drain output (V<sub>DD</sub> tolerance (for the 48-, 32-, 24-pin products)/EV<sub>DD</sub> tolerance (for the 64-, 36-pin products)) mode for the SDAr pin and the normal output mode for the SCLr pin by using port input mode register g (PIMg) and port output mode register h (POMh).

(Remarks are listed on the next page.)

**Simplified I<sup>2</sup>C mode connection diagram (during communication at same potential)**

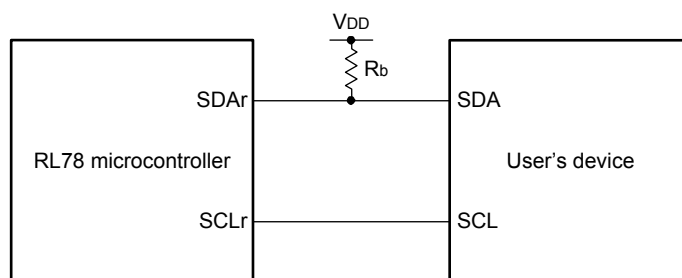

**Simplified I<sup>2</sup>C mode serial transfer timing (during communication at same potential)**

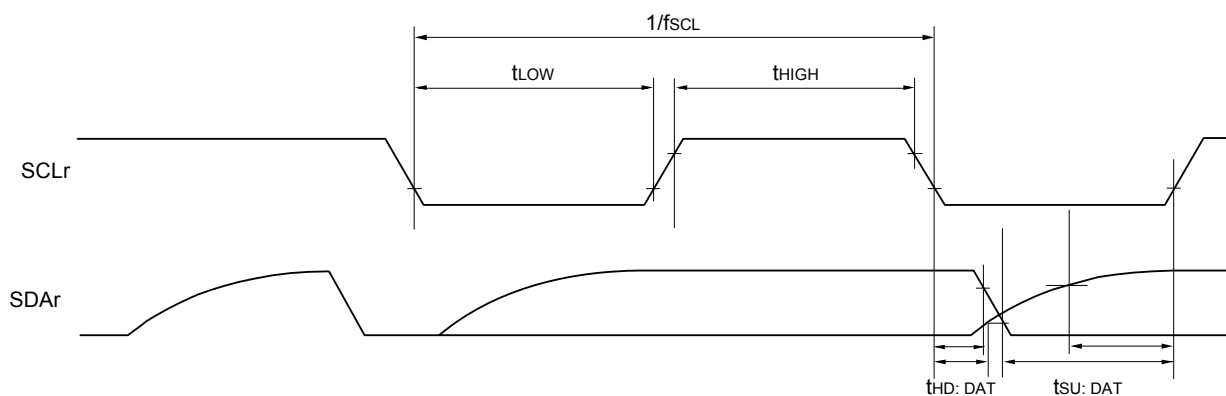

**Remark 1.** R<sub>b</sub>[Ω]: Communication line (SDAr) pull-up resistance, C<sub>b</sub>[F]: Communication line (SDAr, SCLr) load capacitance

**Remark 2.** r: IIC number (r = 00, 01, 10, 11, 20, 21), g: PIM number (g = 0, 1, 3, 5, 7),  
h: POM number (h = 0, 1, 3, 5, 7)

**Remark 3.** f<sub>MCK</sub>: Serial array unit operation clock frequency  
(Operation clock to be set by the CKSmn bit of serial mode register mn (SMRmn). m: Unit number (m = 0, 1),  
n: Channel number (n = 0 to 3), mn = 00 to 03, 10, 11)

**(6) Communication at different potential (1.8 V, 2.5 V, 3 V) (UART mode)****(TA = -40 to +85°C, 1.8 V ≤ EVDD0 ≤ VDD ≤ 5.5 V, VSS = EVSS0 = 0 V)**

Parameter	Symbol	Conditions	HS (high-speed main) mode		LS (low-speed main) mode		LV (low-voltage main) mode		Unit	
			MIN.	MAX.	MIN.	MAX.	MIN.	MAX.		
Transfer rate		reception	4.0 V ≤ EVDD0 ≤ 5.5 V, 2.7 V ≤ Vb ≤ 4.0 V		fMCK/6 Note 1		fMCK/6 Note 1		fMCK/6 Note 1	bps
			Theoretical value of the maximum transfer rate fMCK = fCLK Note 4		5.3		1.3		0.6	Mbps
			2.7 V ≤ EVDD0 < 4.0 V, 2.3 V ≤ Vb ≤ 2.7 V		fMCK/6 Note 1		fMCK/6 Note 1		fMCK/6 Note 1	bps
			Theoretical value of the maximum transfer rate fMCK = fCLK Note 4		5.3		1.3		0.6	Mbps
			1.8 V ≤ EVDD0 < 3.3 V, 1.6 V ≤ Vb ≤ 2.0 V		fMCK/6 Notes 1, 2, 3		fMCK/6 Notes 1, 2		fMCK/6 Notes 1, 2	bps
			Theoretical value of the maximum transfer rate fMCK = fCLK Note 4		5.3		1.3		0.6	Mbps

**Note 1.** Transfer rate in the SNOOZE mode is 4800 bps only.

However, the SNOOZE mode cannot be used when FRQSEL4 = 1.

**Note 2.** Use it with EVDD0 ≥ Vb.

**Note 3.** The following conditions are required for low voltage interface when EVDD0 < VDD.

2.4 V ≤ EVDD0 < 2.7 V: MAX. 2.6 Mbps

1.8 V ≤ EVDD0 < 2.4 V: MAX. 1.3 Mbps

**Note 4.** The maximum operating frequencies of the CPU/peripheral hardware clock (fCLK) are:

HS (high-speed main) mode: 32 MHz (2.7 V ≤ VDD ≤ 5.5 V)

16 MHz (2.4 V ≤ VDD ≤ 5.5 V)

LS (low-speed main) mode: 8 MHz (1.8 V ≤ VDD ≤ 5.5 V)

LV (low-voltage main) mode: 4 MHz (1.6 V ≤ VDD ≤ 5.5 V)

**Caution** Select the TTL input buffer for the RxDq pin and the N-ch open drain output (VDD tolerance (for the 48-, 32-, 24-pin products)/EVDD tolerance (for the 64-, 36-pin products)) mode for the TxDq pin by using port input mode register g (PIMg) and port output mode register g (POMg). For VIH and VIL, see the DC characteristics with TTL input buffer selected.

**Remark 1.** Vb [V]: Communication line voltage

**Remark 2.** q: UART number (q = 0 to 2), g: PIM and POM number (g = 0, 1, 5, 7)

**Remark 3.** fMCK: Serial array unit operation clock frequency

(Operation clock to be set by the CKSmn bit of serial mode register mn (SMRmn). m: Unit number,

n: Channel number (mn = 00 to 03, 10, 11)

**Remark 4.** UART2 cannot communicate at different potential when bit 1 (PIOR01) of peripheral I/O redirection register 0 (PIOR0) is 1.

**(6) Communication at different potential (1.8 V, 2.5 V, 3 V) (UART mode)**

**(TA = -40 to +85°C, 1.8 V ≤ EVDD0 ≤ VDD ≤ 5.5 V, VSS = EVSS0 = 0 V)**

**(2/2)**

Parameter	Symbol	Conditions	HS (high-speed main) mode		LS (low-speed main) mode		LV (low-voltage main) mode		Unit	
			MIN.	MAX.	MIN.	MAX.	MIN.	MAX.		
Transfer rate		transmission	4.0 V ≤ EVDD0 ≤ 5.5 V, 2.7 V ≤ Vb ≤ 4.0 V		Note 1		Note 1		Note 1	bps
			Theoretical value of the maximum transfer rate Cb = 50 pF, Rb = 1.4 kΩ, Vb = 2.7 V		2.8 Note 2		2.8 Note 2		2.8 Note 2	Mbps
			2.7 V ≤ EVDD0 < 4.0 V, 2.3 V ≤ Vb ≤ 2.7 V		Note 3		Note 3		Note 3	bps
			Theoretical value of the maximum transfer rate Cb = 50 pF, Rb = 2.7 kΩ, Vb = 2.3 V		1.2 Note 4		1.2 Note 4		1.2 Note 4	Mbps
			1.8 V ≤ EVDD0 < 3.3 V, 1.6 V ≤ Vb ≤ 2.0 V		Notes 5, 6		Notes 5, 6		Notes 5, 6	bps
			Theoretical value of the maximum transfer rate Cb = 50 pF, Rb = 5.5 kΩ, Vb = 1.6 V		0.43 Note 7		0.43 Note 7		0.43 Note 7	Mbps

**Note 1.** The smaller maximum transfer rate derived by using fmCK/6 or the following expression is the valid maximum transfer rate. Expression for calculating the transfer rate when 4.0 V ≤ EVDD0 ≤ 5.5 V and 2.7 V ≤ Vb ≤ 4.0 V

$$\text{Maximum transfer rate} = \frac{1}{\{-C_b \times R_b \times \ln(1 - \frac{2.2}{V_b})\} \times 3} \text{ [bps]}$$

$$\text{Baud rate error (theoretical value)} = \frac{\frac{1}{\text{Transfer rate} \times 2} - \{-C_b \times R_b \times \ln(1 - \frac{2.2}{V_b})\}}{(\frac{1}{\text{Transfer rate}}) \times \text{Number of transferred bits}} \times 100 \text{ [%]}$$

\* This value is the theoretical value of the relative difference between the transmission and reception sides.

**Note 2.** This value as an example is calculated when the conditions described in the “Conditions” column are met. Refer to **Note 1** above to calculate the maximum transfer rate under conditions of the customer.

**Note 3.** The smaller maximum transfer rate derived by using fmCK/6 or the following expression is the valid maximum transfer rate.

$$\text{Maximum transfer rate} = \frac{1}{\{-C_b \times R_b \times \ln(1 - \frac{2.0}{V_b})\} \times 3} \text{ [bps]}$$

$$\text{Baud rate error (theoretical value)} = \frac{\frac{1}{\text{Transfer rate} \times 2} - \{-C_b \times R_b \times \ln(1 - \frac{2.0}{V_b})\}}{(\frac{1}{\text{Transfer rate}}) \times \text{Number of transferred bits}} \times 100 \text{ [%]}$$

\* This value is the theoretical value of the relative difference between the transmission and reception sides.

Expression for calculating the transfer rate when 2.7 V ≤ EVDD0 < 4.0 V and 2.3 V ≤ Vb ≤ 2.7 V

**Note 4.** This value as an example is calculated when the conditions described in the “Conditions” column are met. Refer to **Note 3** above to calculate the maximum transfer rate under conditions of the customer.

**Note 5.** Use it with EVDD0 ≥ Vb.



**Note 6.** The smaller maximum transfer rate derived by using  $f_{mck}/6$  or the following expression is the valid maximum transfer rate.

Expression for calculating the transfer rate when  $1.8\text{ V} \leq EV_{DD} < 3.3\text{ V}$  and  $1.6\text{ V} \leq V_b \leq 2.0\text{ V}$

$$\text{Maximum transfer rate} = \frac{1}{\{-C_b \times R_b \times \ln(1 - \frac{1.5}{V_b})\} \times 3} \text{ [bps]}$$

$$\text{Baud rate error (theoretical value)} = \frac{\frac{1}{\text{Transfer rate} \times 2} - \{-C_b \times R_b \times \ln(1 - \frac{1.5}{V_b})\}}{\left(\frac{1}{\text{Transfer rate}}\right) \times \text{Number of transferred bits}} \times 100 \text{ [%]}$$

\* This value is the theoretical value of the relative difference between the transmission and reception sides.

**Note 7.** This value as an example is calculated when the conditions described in the "Conditions" column are met. Refer to **Note 6** above to calculate the maximum transfer rate under conditions of the customer.

**Caution** Select the TTL input buffer for the RxDq pin and the N-ch open drain output (V<sub>DD</sub> tolerance (for the 48-, 32-, 24-pin products)/EV<sub>DD</sub> tolerance (for the 64-, 36-pin products)) mode for the TxDq pin by using port input mode register g (PIMg) and port output mode register g (POMg). For V<sub>IH</sub> and V<sub>IL</sub>, see the DC characteristics with TTL input buffer selected.

(Remarks are listed on the next page.)

**UART mode connection diagram (during communication at different potential)**

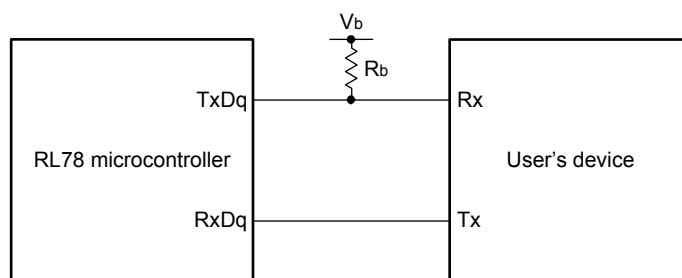

**UART mode bit width (during communication at different potential) (reference)**

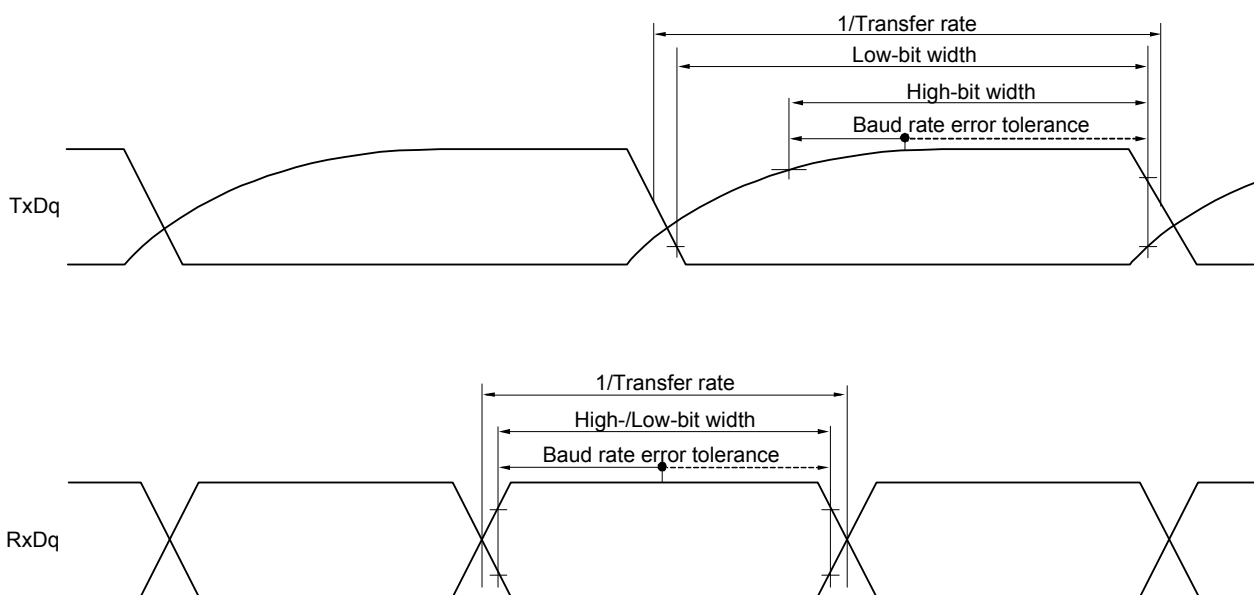

- Remark 1.**  $R_b[\Omega]$ : Communication line (TxDq) pull-up resistance,  
 $C_b[F]$ : Communication line (TxDq) load capacitance,  $V_b[V]$ : Communication line voltage
- Remark 2.** q: UART number (q = 0 to 2), g: PIM and POM number (g = 0, 1, 5, 7)
- Remark 3.**  $f_{mck}$ : Serial array unit operation clock frequency  
 (Operation clock to be set by the CKSmn bit of serial mode register mn (SMRmn).  
 m: Unit number, n: Channel number (mn = 00 to 03, 10, 11))
- Remark 4.** UART2 cannot communicate at different potential when bit 1 (PIOR01) of peripheral I/O redirection register 0 (PIOR0) is 1.

**(7) Communication at different potential (2.5 V, 3 V) (CSI mode) (master mode, SCKp... internal clock output, corresponding CSI00 only)****(TA = -40 to +85°C, 2.7 V ≤ EVDD0 ≤ VDD ≤ 5.5 V, VSS = EVSS0 = 0 V)**

Parameter	Symbol	Conditions	HS (high-speed main) mode		LS (low-speed main) mode		LV (low-voltage main) mode		Unit
			MIN.	MAX.	MIN.	MAX.	MIN.	MAX.	
SCKp cycle time	tkCY1	tkCY1 ≥ 2/fCLK 4.0 V ≤ EVDD0 ≤ 5.5 V, 2.7 V ≤ Vb ≤ 4.0 V, Cb = 20 pF, Rb = 1.4 kΩ	200		1150		1150		ns
			300		1150		1150		ns
SCKp high-level width	tkH1	4.0 V ≤ EVDD0 ≤ 5.5 V, 2.7 V ≤ Vb ≤ 4.0 V, Cb = 20 pF, Rb = 1.4 kΩ	tkCY1/2 - 50		tkCY1/2 - 50		tkCY1/2 - 50		ns
		2.7 V ≤ EVDD0 < 4.0 V, 2.3 V ≤ Vb ≤ 2.7 V, Cb = 20 pF, Rb = 2.7 kΩ	tkCY1/2 - 120		tkCY1/2 - 120		tkCY1/2 - 120		ns
SCKp low-level width	tkL1	4.0 V ≤ EVDD0 ≤ 5.5 V, 2.7 V ≤ Vb ≤ 4.0 V, Cb = 20 pF, Rb = 1.4 kΩ	tkCY1/2 - 7		tkCY1/2 - 50		tkCY1/2 - 50		ns
		2.7 V ≤ EVDD0 < 4.0 V, 2.3 V ≤ Vb ≤ 2.7 V, Cb = 20 pF, Rb = 2.7 kΩ	tkCY1/2 - 10		tkCY1/2 - 50		tkCY1/2 - 50		ns
Slp setup time (to SCKp↑) Note 1	tSIK1	4.0 V ≤ EVDD0 ≤ 5.5 V, 2.7 V ≤ Vb ≤ 4.0 V, Cb = 20 pF, Rb = 1.4 kΩ	58		479		479		ns
		2.7 V ≤ EVDD0 < 4.0 V, 2.3 V ≤ Vb ≤ 2.7 V, Cb = 20 pF, Rb = 2.7 kΩ	121		479		479		ns
Slp hold time (from SCKp↑) Note 1	tKSI1	4.0 V ≤ EVDD0 ≤ 5.5 V, 2.7 V ≤ Vb ≤ 4.0 V, Cb = 20 pF, Rb = 1.4 kΩ	10		10		10		ns
		2.7 V ≤ EVDD0 < 4.0 V, 2.3 V ≤ Vb ≤ 2.7 V, Cb = 20 pF, Rb = 2.7 kΩ	10		10		10		ns
Delay time from SCKp↓ to SOp out- put Note 1	tkSO1	4.0 V ≤ EVDD0 ≤ 5.5 V, 2.7 V ≤ Vb ≤ 4.0 V, Cb = 20 pF, Rb = 1.4 kΩ		60		60		60	ns
		2.7 V ≤ EVDD0 < 4.0 V, 2.3 V ≤ Vb ≤ 2.7 V, Cb = 20 pF, Rb = 2.7 kΩ		130		130		130	ns

(Notes, Caution, and Remarks are listed on the next page.)

**(7) Communication at different potential (2.5 V, 3 V) (CSI mode) (master mode, SCKp... internal clock output, corresponding CSI00 only)****(TA = -40 to +85°C, 2.7 V ≤ EVDD0 ≤ VDD ≤ 5.5 V, VSS = EVSS0 = 0 V)****(2/2)**

Parameter	Symbol	Conditions	HS (high-speed main) mode		LS (low-speed main) mode		LV (low-voltage main) mode		Unit
			MIN.	MAX.	MIN.	MAX.	MIN.	MAX.	
Slp setup time (to SCKp↓) Note 2	tSIK1	4.0 V ≤ EVDD0 ≤ 5.5 V, 2.7 V ≤ Vb ≤ 4.0 V, Cb = 20 pF, Rb = 1.4 kΩ	23		110		110		ns
		2.7 V ≤ EVDD0 < 4.0 V, 2.3 V ≤ Vb ≤ 2.7 V, Cb = 20 pF, Rb = 2.7 kΩ	33		110		110		ns
Slp hold time (from SCKp↓) Note 2	tKSI1	4.0 V ≤ EVDD0 ≤ 5.5 V, 2.7 V ≤ Vb ≤ 4.0 V, Cb = 20 pF, Rb = 1.4 kΩ	10		10		10		ns
		2.7 V ≤ EVDD0 < 4.0 V, 2.3 V ≤ Vb ≤ 2.7 V, Cb = 20 pF, Rb = 2.7 kΩ	10		10		10		ns
Delay time from SCKp↑ to SOp output Note 2	tKSO1	4.0 V ≤ EVDD0 ≤ 5.5 V, 2.7 V ≤ Vb ≤ 4.0 V, Cb = 20 pF, Rb = 1.4 kΩ		10		10		10	ns
		2.7 V ≤ EVDD0 < 4.0 V, 2.3 V ≤ Vb ≤ 2.7 V, Cb = 20 pF, Rb = 2.7 kΩ		10		10		10	ns

**Note 1.** When DAPmn = 0 and CKPmn = 0, or DAPmn = 1 and CKPmn = 1.

**Note 2.** When DAPmn = 0 and CKPmn = 1, or DAPmn = 1 and CKPmn = 0.

**Caution** Select the TTL input buffer for the Slp pin and the N-ch open drain output (VDD tolerance (for the 48-, 32-, 24-pin products)/EVDD tolerance (for the 64-, 36-pin products)) mode for the SOp pin and SCKp pin by using port input mode register g (PIMg) and port output mode register g (POMg). For VIH and VIL, see the DC characteristics with TTL input buffer selected.

**Remark 1.** Rb[Ω]: Communication line (SCKp, SOp) pull-up resistance, Cb[F]: Communication line (SCKp, SOp) load capacitance, Vb[V]: Communication line voltage

**Remark 2.** p: CSI number (p = 00), m: Unit number (m = 0), n: Channel number (n = 0), g: PIM and POM number (g = 3, 5)

**Remark 3.** fMCK: Serial array unit operation clock frequency

(Operation clock to be set by the CKSmn bit of serial mode register mn (SMRmn). m: Unit number, n: Channel number (mn = 00))

**Remark 4.** This value is valid only when CSI00's peripheral I/O redirect function is not used.

**(8) Communication at different potential (1.8 V, 2.5 V, 3 V) (CSI mode) (master mode, SCKp... internal clock output)****(TA = -40 to +85°C, 1.8 V ≤ EVDD0 ≤ VDD ≤ 5.5 V, VSS = EVSS0 = 0 V)****(1/3)**

Parameter	Symbol	Conditions	HS (high-speed main) mode		LS (low-speed main) mode		LV (low-voltage main) mode		Unit
			MIN.	MAX.	MIN.	MAX.	MIN.	MAX.	
SCKp cycle time	tkCY1	tkCY1 ≥ 4/fCLK 4.0 V ≤ EVDD0 ≤ 5.5 V, 2.7 V ≤ Vb ≤ 4.0 V, Cb = 30 pF, Rb = 1.4 kΩ	300		1150		1150		ns
			500		1150		1150		ns
			1150		1150		1150		ns
SCKp high-level width	tkH1	4.0 V ≤ EVDD0 ≤ 5.5 V, 2.7 V ≤ Vb ≤ 4.0 V, Cb = 30 pF, Rb = 1.4 kΩ	tkCY1/2 - 75		tkCY1/2 - 75		tkCY1/2 - 75		ns
			tkCY1/2 - 170		tkCY1/2 - 170		tkCY1/2 - 170		ns
			tkCY1/2 - 458		tkCY1/2 - 458		tkCY1/2 - 458		ns
SCKp low-level width	tkL1	4.0 V ≤ EVDD0 ≤ 5.5 V, 2.7 V ≤ Vb ≤ 4.0 V, Cb = 30 pF, Rb = 1.4 kΩ	tkCY1/2 - 12		tkCY1/2 - 50		tkCY1/2 - 50		ns
			tkCY1/2 - 18		tkCY1/2 - 50		tkCY1/2 - 50		ns
			tkCY1/2 - 50		tkCY1/2 - 50		tkCY1/2 - 50		ns

**Note** Use it with EVDD0 ≥ Vb.

**Caution** Select the TTL input buffer for the Slp pin and the N-ch open drain output (VDD tolerance (for the 48-, 32-, 24-pin products)/EVDD tolerance (for the 64-, 36-pin products)) mode for the SOp pin and SCKp pin by using port input mode register g (PIMg) and port output mode register g (POMg). For VIH and VIL, see the DC characteristics with TTL input buffer selected.

(Remarks are listed two pages after the next page.)

**(8) Communication at different potential (1.8 V, 2.5 V, 3 V) (CSI mode) (master mode, SCKp... internal clock output)****(TA = -40 to +85°C, 1.8 V ≤ EVDD0 ≤ VDD ≤ 5.5 V, VSS = EVSS0 = 0 V)****(2/3)**

Parameter	Symbol	Conditions	HS (high-speed main) mode		LS (low-speed main) mode		LV (low-voltage main) mode		Unit
			MIN.	MAX.	MIN.	MAX.	MIN.	MAX.	
Slp setup time (to SCKp↑) Note 1	tSIK1	4.0 V ≤ EVDD0 ≤ 5.5 V, 2.7 V ≤ Vb ≤ 4.0 V, Cb = 30 pF, Rb = 1.4 kΩ	81		479		479		ns
		2.7 V ≤ EVDD0 < 4.0 V, 2.3 V ≤ Vb ≤ 2.7 V, Cb = 30 pF, Rb = 2.7 kΩ	177		479		479		ns
		1.8 V ≤ EVDD0 < 3.3 V, 1.6 V ≤ Vb ≤ 2.0 V Note 2, Cb = 30 pF, Rb = 5.5 kΩ	479		479		479		ns
Slp hold time (from SCKp↑) Note 1	tKSI1	4.0 V ≤ EVDD0 ≤ 5.5 V, 2.7 V ≤ Vb ≤ 4.0 V, Cb = 30 pF, Rb = 1.4 kΩ	19		19		19		ns
		2.7 V ≤ EVDD0 < 4.0 V, 2.3 V ≤ Vb ≤ 2.7 V, Cb = 30 pF, Rb = 2.7 kΩ	19		19		19		ns
		1.8 V ≤ EVDD0 < 3.3 V, 1.6 V ≤ Vb ≤ 2.0 V Note 2, Cb = 30 pF, Rb = 5.5 kΩ	19		19		19		ns
Delay time from SCKp↓ to SOp output Note 1	tKSO1	4.0 V ≤ EVDD0 ≤ 5.5 V, 2.7 V ≤ Vb ≤ 4.0 V, Cb = 30 pF, Rb = 1.4 kΩ		100		100		100	ns
		2.7 V ≤ EVDD0 < 4.0 V, 2.3 V ≤ Vb ≤ 2.7 V, Cb = 30 pF, Rb = 2.7 kΩ		195		195		195	ns
		1.8 V ≤ EVDD0 < 3.3 V, 1.6 V ≤ Vb ≤ 2.0 V Note 2, Cb = 30 pF, Rb = 5.5 kΩ		483		483		483	ns

**Note 1.** When DAPmn = 0 and CKPmn = 0, or DAPmn = 1 and CKPmn = 1.**Note 2.** Use it with EVDD0 ≥ Vb.

**Caution** Select the TTL input buffer for the Slp pin and the N-ch open drain output (VDD tolerance (for the 48-, 32-, 24-pin products)/EVDD tolerance (for the 64-, 36-pin products)) mode for the SOp pin and SCKp pin by using port input mode register g (PIMg) and port output mode register g (POMg). For VIH and VIL, see the DC characteristics with TTL input buffer selected.

(Remarks are listed on the page after the next page.)

**(8) Communication at different potential (1.8 V, 2.5 V, 3 V) (CSI mode) (master mode, SCKp... internal clock output)****(TA = -40 to +85°C, 1.8 V ≤ EVDD0 ≤ VDD ≤ 5.5 V, VSS = EVSS0 = 0 V)****(3/3)**

Parameter	Symbol	Conditions	HS (high-speed main) mode		LS (low-speed main) mode		LV (low-voltage main) mode		Unit
			MIN.	MAX.	MIN.	MAX.	MIN.	MAX.	
Slp setup time (to SCKp↓) Note 1	tSIK1	4.0 V ≤ EVDD0 ≤ 5.5 V, 2.7 V ≤ Vb ≤ 4.0 V, Cb = 30 pF, Rb = 1.4 kΩ	44		110		110		ns
		2.7 V ≤ EVDD0 < 4.0 V, 2.3 V ≤ Vb ≤ 2.7 V, Cb = 30 pF, Rb = 2.7 kΩ	44		110		110		ns
		1.8 V ≤ EVDD0 < 3.3 V, 1.6 V ≤ Vb ≤ 2.0 V Note 2, Cb = 30 pF, Rb = 5.5 kΩ	110		110		110		ns
Slp hold time (from SCKp↓) Note 1	tKSI1	4.0 V ≤ EVDD0 ≤ 5.5 V, 2.7 V ≤ Vb ≤ 4.0 V, Cb = 30 pF, Rb = 1.4 kΩ	19		19		19		ns
		2.7 V ≤ EVDD0 < 4.0 V, 2.3 V ≤ Vb ≤ 2.7 V, Cb = 30 pF, Rb = 2.7 kΩ	19		19		19		ns
		1.8 V ≤ EVDD0 < 3.3 V, 1.6 V ≤ Vb ≤ 2.0 V Note 2, Cb = 30 pF, Rb = 5.5 kΩ	19		19		19		ns
Delay time from SCKp↑ to SOp output Note 1	tKSO1	4.0 V ≤ EVDD0 ≤ 5.5 V, 2.7 V ≤ Vb ≤ 4.0 V, Cb = 30 pF, Rb = 1.4 kΩ		25		25		25	ns
		2.7 V ≤ EVDD0 < 4.0 V, 2.3 V ≤ Vb ≤ 2.7 V, Cb = 30 pF, Rb = 2.7 kΩ		25		25		25	ns
		1.8 V ≤ EVDD0 < 3.3 V, 1.6 V ≤ Vb ≤ 2.0 V Note 2, Cb = 30 pF, Rb = 5.5 kΩ		25		25		25	ns

**Note 1.** When DAPmn = 0 and CKPmn = 1, or DAPmn = 1 and CKPmn = 0.**Note 2.** Use it with EVDD0 ≥ Vb.

**Caution** Select the TTL input buffer for the Slp pin and the N-ch open drain output (VDD tolerance (for the 48-, 32-, 24-pin products)/EVDD tolerance (for the 64-, 36-pin products)) mode for the SOp pin and SCKp pin by using port input mode register g (PIMg) and port output mode register g (POMg). For VIH and VIL, see the DC characteristics with TTL input buffer selected.

(Remarks are listed on the next page.)

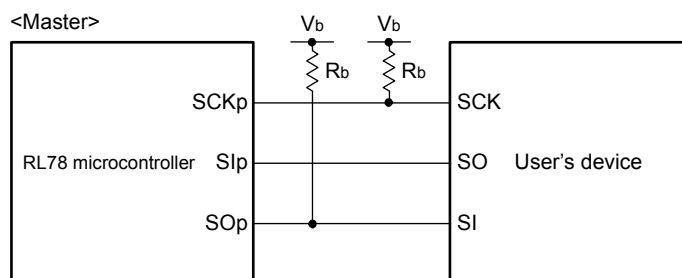
**CSI mode connection diagram (during communication at different potential)**

**Remark 1.**  $R_b[\Omega]$ : Communication line (SCKp, SOp) pull-up resistance,  $C_b[F]$ : Communication line (SCKp, SOp) load capacitance,  $V_b[V]$ : Communication line voltage

**Remark 2.** p: CSI number (p = 00, 01, 10, 20), m: Unit number (m = 0, 1), n: Channel number (n = 0 to 3), g: PIM and POM number (g = 0, 1, 3, 5, 7)

**Remark 3.**  $f_{mck}$ : Serial array unit operation clock frequency  
(Operation clock to be set by the CKSmn bit of serial mode register mn (SMRmn). m: Unit number, n: Channel number (mn = 00))

**Remark 4.** CSI01 of 48-, 64-pin products, and CSI11 and CSI21 cannot communicate at different potential. Use other CSI for communication at different potential.



**CSI mode serial transfer timing (master mode) (during communication at different potential)**  
**(When DAPmn = 0 and CKPmn = 0, or DAPmn = 1 and CKPmn = 1.)**

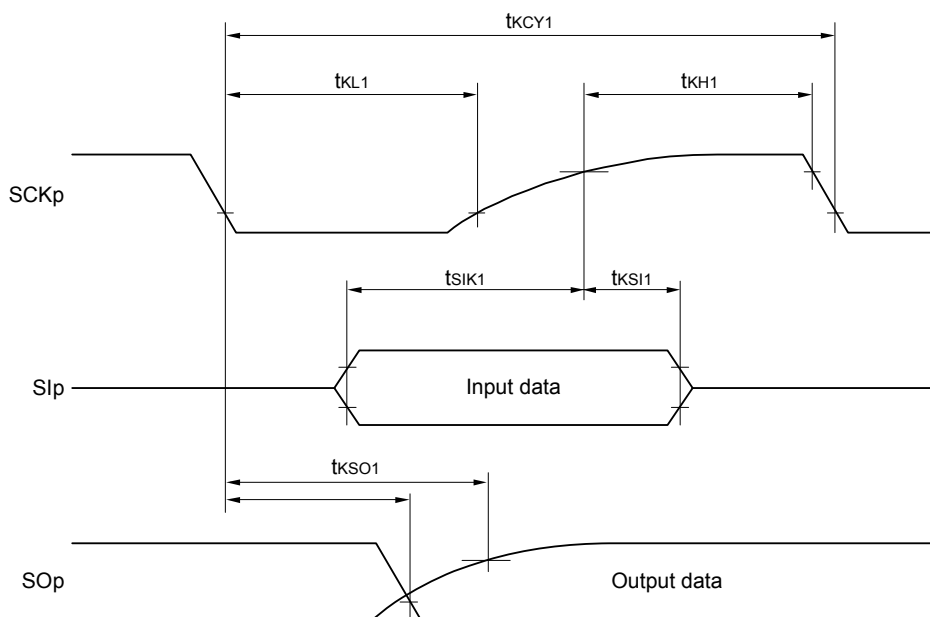

**CSI mode serial transfer timing (master mode) (during communication at different potential)**  
**(When DAPmn = 0 and CKPmn = 1, or DAPmn = 1 and CKPmn = 0.)**

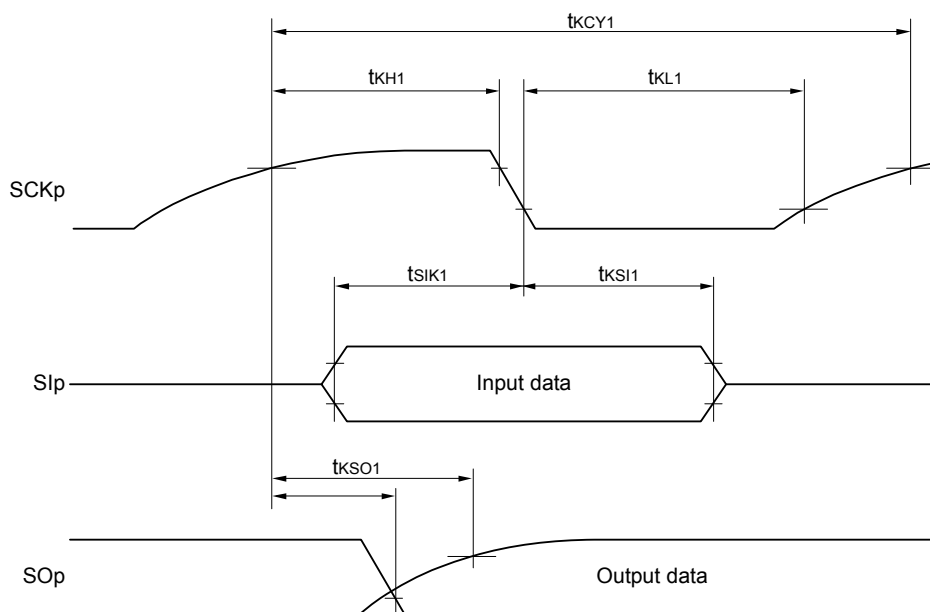

**Remark 1.** p: CSI number (p = 00, 01, 10, 20), m: Unit number (m = 0, 1), n: Channel number (n = 0 to 3),  
 g: PIM and POM number (g = 0, 1, 3, 5, 7)

**Remark 2.** CSI01 of 48-, 64-pin products, and CSI11 and CSI21 cannot communicate at different potential. Use other CSI for communication at different potential.

**(9) Communication at different potential (1.8 V, 2.5 V, 3 V) (CSI mode) (slave mode, SCKp... external clock input)****(TA = -40 to +85°C, 1.8 V ≤ EVDD0 ≤ VDD ≤ 5.5 V, VSS = EVSS0 = 0 V)**

Parameter	Symbol	Conditions	HS (high-speed main) mode		LS (low-speed main) mode		LV (low-voltage main) mode		Unit	
			MIN.	MAX.	MIN.	MAX.	MIN.	MAX.		
SCKp cycle time Note 1	tkcy2	4.0 V ≤ EVDD0 ≤ 5.5 V, 2.7 V ≤ Vb ≤ 4.0 V	24 MHz < fmck	14/fmck		—		—	ns	
			20 MHz < fmck ≤ 24 MHz	12/fmck		—		—	ns	
			8 MHz < fmck ≤ 20 MHz	10/fmck		—		—	ns	
			4 MHz < fmck ≤ 8 MHz	8/fmck		16/fmck		—	ns	
			fmck ≤ 4 MHz	6/fmck		10/fmck		10/fmck	ns	
		2.7 V ≤ EVDD0 < 4.0 V, 2.3 V ≤ Vb ≤ 2.7 V	24 MHz < fmck	20/fmck		—		—	ns	
			20 MHz < fmck ≤ 24 MHz	16/fmck		—		—	ns	
			16 MHz < fmck ≤ 20 MHz	14/fmck		—		—	ns	
			8 MHz < fmck ≤ 16 MHz	12/fmck		—		—	ns	
			4 MHz < fmck ≤ 8 MHz	8/fmck		16/fmck		—	ns	
		1.8 V ≤ EVDD0 < 3.3 V, 1.6 V ≤ Vb ≤ 2.0 V Note 2	24 MHz < fmck	48/fmck		—		—	ns	
			20 MHz < fmck ≤ 24 MHz	36/fmck		—		—	ns	
			16 MHz < fmck ≤ 20 MHz	32/fmck		—		—	ns	
			8 MHz < fmck ≤ 16 MHz	26/fmck		—		—	ns	
			4 MHz < fmck ≤ 8 MHz	16/fmck		16/fmck		—	ns	
SCKp high-/ low-level width	tkH2, tkL2	4.0 V ≤ EVDD0 ≤ 5.5 V, 2.7 V ≤ Vb ≤ 4.0 V	tkcy2/2		tkcy2/2		tkcy2/2		ns	
			- 12		- 50		- 50		ns	
			2.7 V ≤ EVDD0 < 4.0 V, 2.3 V ≤ Vb ≤ 2.7 V	tkcy2/2		tkcy2/2		tkcy2/2		ns
	1.8 V ≤ EVDD0 < 3.3 V, 1.6 V ≤ Vb ≤ 2.0 V Note 2	- 18		- 50		- 50		ns		
		tkcy2/2		tkcy2/2		tkcy2/2		ns		
		- 50		- 50		- 50		ns		
	Slp setup time (to SCKp↑) Note 3	tsik2	4.0 V ≤ EVDD0 ≤ 5.5 V, 2.7 V ≤ Vb ≤ 4.0 V	1/fmck		1/fmck		1/fmck		ns
				+ 20		+ 30		+ 30		ns
				2.7 V ≤ EVDD0 ≤ 4.0 V, 2.3 V ≤ Vb ≤ 2.7 V	1/fmck		1/fmck		1/fmck	
	1.8 V ≤ EVDD0 ≤ 3.3 V, 1.6 V ≤ Vb ≤ 2.0 V Note 2	+ 20		+ 30		+ 30		ns		
		1/fmck		1/fmck		1/fmck		ns		
		+ 30		+ 30		+ 30		ns		
	Slp hold time (from SCKp↑) Note 4	tksl2		1/fmck		1/fmck		1/fmck		ns
	Delay time from SCKp↓ to SOp output Note 5	tkso2	4.0 V ≤ EVDD0 ≤ 5.5 V, 2.7 V ≤ Vb ≤ 4.0 V, Cb = 30 pF, Rb = 1.4 kΩ	2/fmck		2/fmck		2/fmck		ns
				+ 120		+ 573		+ 573		ns
2.7 V ≤ EVDD0 < 4.0 V, 2.3 V ≤ Vb ≤ 2.7 V, Cb = 30 pF, Rb = 2.7 kΩ				2/fmck		2/fmck		2/fmck		ns
1.8 V ≤ EVDD0 < 3.3 V, 1.6 V ≤ Vb ≤ 2.0 V Note 2, Cb = 30 pF, Rv = 5.5 kΩ	+ 214		+ 573		+ 573		ns			
	2/fmck		2/fmck		2/fmck		ns			
+ 573		+ 573		+ 573		ns				

(Notes, Cautions, and Remarks are listed on the next page.)

- Note 1.** Transfer rate in the SNOOZE mode: MAX. 1 Mbps
- Note 2.** Use it with  $EV_{DD0} \geq V_b$ .
- Note 3.** When  $DAP_{mn} = 0$  and  $CKP_{mn} = 0$ , or  $DAP_{mn} = 1$  and  $CKP_{mn} = 1$ . The  $S_{lp}$  setup time becomes “to  $SCK_{p\downarrow}$ ” when  $DAP_{mn} = 0$  and  $CKP_{mn} = 1$ , or  $DAP_{mn} = 1$  and  $CKP_{mn} = 0$ .
- Note 4.** When  $DAP_{mn} = 0$  and  $CKP_{mn} = 0$ , or  $DAP_{mn} = 1$  and  $CKP_{mn} = 1$ . The  $S_{lp}$  hold time becomes “from  $SCK_{p\downarrow}$ ” when  $DAP_{mn} = 0$  and  $CKP_{mn} = 1$ , or  $DAP_{mn} = 1$  and  $CKP_{mn} = 0$ .
- Note 5.** When  $DAP_{mn} = 0$  and  $CKP_{mn} = 0$ , or  $DAP_{mn} = 1$  and  $CKP_{mn} = 1$ . The delay time to  $S_{Op}$  output becomes “from  $SCK_{p\uparrow}$ ” when  $DAP_{mn} = 0$  and  $CKP_{mn} = 1$ , or  $DAP_{mn} = 1$  and  $CKP_{mn} = 0$ .
- Caution** Select the TTL input buffer for the  $S_{lp}$  pin and  $SCK_{p}$  pin, and the N-ch open drain output ( $V_{DD}$  tolerance (for the 48-, 32-, 24-pin products)/ $EV_{DD}$  tolerance (for the 64-, 36-pin products)) mode for the  $S_{Op}$  pin by using port input mode register g (PIMg) and port output mode register g (POMg). For  $V_{IH}$  and  $V_{IL}$ , see the DC characteristics with TTL input buffer selected.

**CSI mode connection diagram (during communication at different potential)**

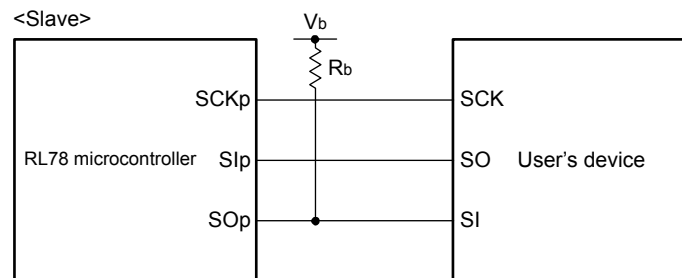

- Remark 1.**  $R_b[\Omega]$ : Communication line ( $S_{Op}$ ) pull-up resistance,  $C_b[F]$ : Communication line ( $S_{Op}$ ) load capacitance,  $V_b[V]$ : Communication line voltage
- Remark 2.** p: CSI number (p = 00, 01, 10, 20), m: Unit number (m = 0, 1), n: Channel number (n = 0 to 3), g: PIM and POM number (g = 0, 1, 3, 5, 7)
- Remark 3.**  $f_{mck}$ : Serial array unit operation clock frequency  
(Operation clock to be set by the  $CKS_{mn}$  bit of serial mode register mn ( $SMR_{mn}$ ).  
m: Unit number, n: Channel number (mn = 00, 01, 02, 10))
- Remark 4.** CSI01 of 48-, 64-pin products, and CSI11 and CSI21 cannot communicate at different potential. Use other CSI for communication at different potential.  
Also, communication at different potential cannot be performed during clock synchronous serial communication with the slave select function.

**CSI mode serial transfer timing (slave mode) (during communication at different potential)**  
**(When DAPmn = 0 and CKPmn = 0, or DAPmn = 1 and CKPmn = 1.)**

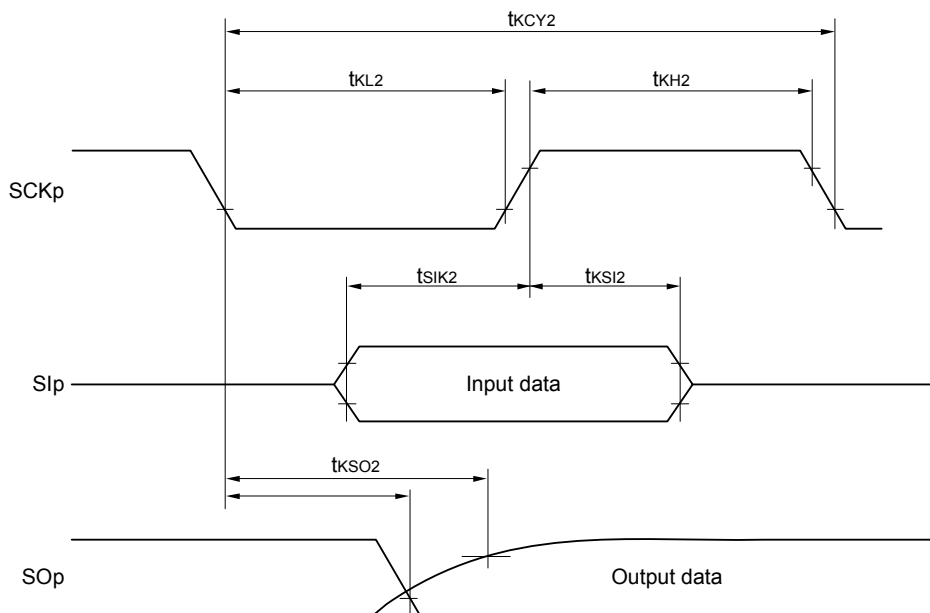

**CSI mode serial transfer timing (slave mode) (during communication at different potential)**  
**(When DAPmn = 0 and CKPmn = 1, or DAPmn = 1 and CKPmn = 0.)**

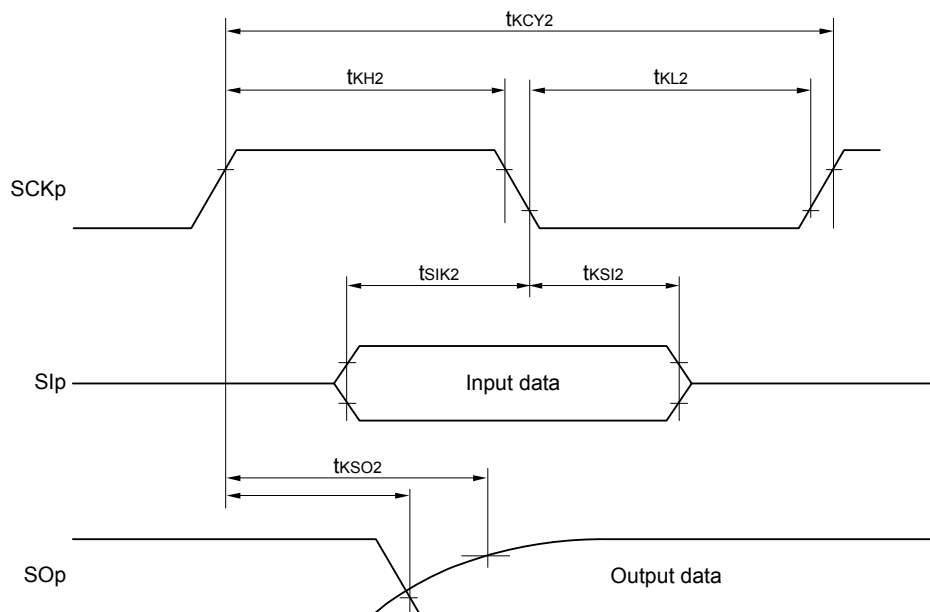

**Remark 1.** p: CSI number (p = 00, 01, 10, 20), m: Unit number (m = 0, 1), n: Channel number (n = 0 to 3),  
g: PIM and POM number (g = 0, 1, 3, 5, 7)

**Remark 2.** CSI01 of 48-, 64-pin products, and CSI11 and CSI21 cannot communicate at different potential. Use other CSI for communication at different potential.  
Also, communication at different potential cannot be performed during clock synchronous serial communication with the slave select function.

**(10) Communication at different potential (1.8 V, 2.5 V, 3 V) (simplified I<sup>2</sup>C mode)****(TA = -40 to +85°C, 1.8 V ≤ EVDD0 ≤ VDD ≤ 5.5 V, VSS = EVSS0 = 0 V)**

Parameter	Symbol	Conditions	HS (high-speed main) mode		LS (low-speed main) mode		LV (low-voltage main) mode		Unit
			MIN.	MAX.	MIN.	MAX.	MIN.	MAX.	
SCLr clock frequency	f <sub>SCL</sub>	4.0 V ≤ EVDD0 ≤ 5.5 V, 2.7 V ≤ Vb ≤ 4.0 V, Cb = 50 pF, Rb = 2.7 kΩ		1000 Note 1		300 Note 1		300 Note 1	kHz
		2.7 V ≤ EVDD0 < 4.0 V, 2.3 V ≤ Vb ≤ 2.7 V, Cb = 50 pF, Rb = 2.7 kΩ		1000 Note 1		300 Note 1		300 Note 1	kHz
		4.0 V ≤ EVDD0 ≤ 5.5 V, 2.7 V ≤ Vb ≤ 4.0 V, Cb = 100 pF, Rb = 2.8 kΩ		400 Note 1		300 Note 1		300 Note 1	kHz
		2.7 V ≤ EVDD0 < 4.0 V, 2.3 V ≤ Vb ≤ 2.7 V, Cb = 100 pF, Rb = 2.7 kΩ		400 Note 1		300 Note 1		300 Note 1	kHz
		1.8 V ≤ EVDD0 < 3.3 V, 1.6 V ≤ Vb ≤ 2.0 V Note 2, Cb = 100 pF, Rb = 5.5 kΩ		300 Note 1		300 Note 1		300 Note 1	kHz
Hold time when SCLr = "L"	t <sub>LOW</sub>	4.0 V ≤ EVDD0 ≤ 5.5 V, 2.7 V ≤ Vb ≤ 4.0 V, Cb = 50 pF, Rb = 2.7 kΩ	475		1550		1550		ns
		2.7 V ≤ EVDD0 < 4.0 V, 2.3 V ≤ Vb ≤ 2.7 V, Cb = 50 pF, Rb = 2.7 kΩ	475		1550		1550		ns
		4.0 V ≤ EVDD0 ≤ 5.5 V, 2.7 V ≤ Vb ≤ 4.0 V, Cb = 100 pF, Rb = 2.8 kΩ	1150		1550		1550		ns
		2.7 V ≤ EVDD0 < 4.0 V, 2.3 V ≤ Vb ≤ 2.7 V, Cb = 100 pF, Rb = 2.7 kΩ	1150		1550		1550		ns
		1.8 V ≤ EVDD0 < 3.3 V, 1.6 V ≤ Vb ≤ 2.0 V Note 2, Cb = 100 pF, Rb = 5.5 kΩ	1550		1550		1550		ns
Hold time when SCLr = "H"	t <sub>HIGH</sub>	4.0 V ≤ EVDD0 ≤ 5.5 V, 2.7 V ≤ Vb ≤ 4.0 V, Cb = 50 pF, Rb = 2.7 kΩ	245		610		610		ns
		2.7 V ≤ EVDD0 < 4.0 V, 2.3 V ≤ Vb ≤ 2.7 V, Cb = 50 pF, Rb = 2.7 kΩ	200		610		610		ns
		4.0 V ≤ EVDD0 ≤ 5.5 V, 2.7 V ≤ Vb ≤ 4.0 V, Cb = 100 pF, Rb = 2.8 kΩ	675		610		610		ns
		2.7 V ≤ EVDD0 < 4.0 V, 2.3 V ≤ Vb ≤ 2.7 V, Cb = 100 pF, Rb = 2.7 kΩ	600		610		610		ns
		1.8 V ≤ EVDD0 < 3.3 V, 1.6 V ≤ Vb ≤ 2.0 V Note 2, Cb = 100 pF, Rb = 5.5 kΩ	610		610		610		ns

**(10) Communication at different potential (1.8 V, 2.5 V, 3 V) (simplified I<sup>2</sup>C mode)****(TA = -40 to +85°C, 1.8 V ≤ EVDD0 ≤ VDD ≤ 5.5 V, VSS = EVSS0 = 0 V)****(2/2)**

Parameter	Symbol	Conditions	HS (high-speed main) mode		LS (low-speed main) mode		LV (low-voltage main) mode		Unit
			MIN.	MAX.	MIN.	MAX.	MIN.	MAX.	
Data setup time (reception)	tsu:DAT	4.0 V ≤ EVDD0 ≤ 5.5 V, 2.7 V ≤ Vb ≤ 4.0 V, Cb = 50 pF, Rb = 2.7 kΩ	1/fMCK + 135 Note 3		1/fMCK + 190 Note 3		1/fMCK + 190 Note 3		ns
		2.7 V ≤ EVDD0 < 4.0 V, 2.3 V ≤ Vb ≤ 2.7 V, Cb = 50 pF, Rb = 2.7 kΩ	1/fMCK + 135 Note 3		1/fMCK + 190 Note 3		1/fMCK + 190 Note 3		ns
		4.0 V ≤ EVDD0 ≤ 5.5 V, 2.7 V ≤ Vb ≤ 4.0 V, Cb = 100 pF, Rb = 2.8 kΩ	1/fMCK + 190 Note 3		1/fMCK + 190 Note 3		1/fMCK + 190 Note 3		ns
		2.7 V ≤ EVDD0 < 4.0 V, 2.3 V ≤ Vb ≤ 2.7 V, Cb = 100 pF, Rb = 2.7 kΩ	1/fMCK + 190 Note 3		1/fMCK + 190 Note 3		1/fMCK + 190 Note 3		ns
		1.8 V ≤ EVDD0 < 3.3 V, 1.6 V ≤ Vb ≤ 2.0 V Note 2, Cb = 100 pF, Rb = 5.5 kΩ	1/fMCK + 190 Note 3		1/fMCK + 190 Note 3		1/fMCK + 190 Note 3		ns
Data hold time (transmission)	tHD:DAT	4.0 V ≤ EVDD0 ≤ 5.5 V, 2.7 V ≤ Vb ≤ 4.0 V, Cb = 50 pF, Rb = 2.7 kΩ	0	305	0	305	0	305	ns
		2.7 V ≤ EVDD0 < 4.0 V, 2.3 V ≤ Vb ≤ 2.7 V, Cb = 50 pF, Rb = 2.7 kΩ	0	305	0	305	0	305	ns
		4.0 V ≤ EVDD0 ≤ 5.5 V, 2.7 V ≤ Vb ≤ 4.0 V, Cb = 100 pF, Rb = 2.8 kΩ	0	355	0	355	0	355	ns
		2.7 V ≤ EVDD0 < 4.0 V, 2.3 V ≤ Vb ≤ 2.7 V, Cb = 100 pF, Rb = 2.7 kΩ	0	355	0	355	0	355	ns
		1.8 V ≤ EVDD0 < 3.3 V, 1.6 V ≤ Vb ≤ 2.0 V Note 2, Cb = 100 pF, Rb = 5.5 kΩ	0	405	0	405	0	405	ns

**Note 1.** The value must also be equal to or less than fMCK/4.

**Note 2.** Use it with EVDD0 ≥ Vb.

**Note 3.** Set the fMCK value to keep the hold time of SCLr = "L" and SCLr = "H".

**Caution** Select the TTL input buffer and the N-ch open drain output (VDD tolerance (for the 48-, 32-, 24-pin products)/EVDD tolerance (for the 64-, 36-pin products)) mode for the SDAr pin and the N-ch open drain output (VDD tolerance (for the 48-, 32-, 24-pin products)/EVDD tolerance (for the 64-, 36-pin products)) mode for the SCLr pin by using port input mode register g (PIMg) and port output mode register g (POMg). For VIH and VIL, see the DC characteristics with TTL input buffer selected.

(Remarks are listed on the next page.)

**Simplified I<sup>2</sup>C mode connection diagram (during communication at different potential)**

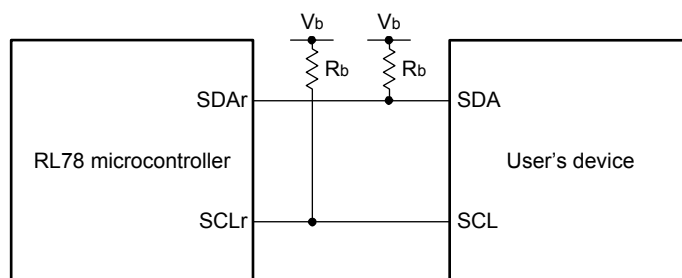

**Simplified I<sup>2</sup>C mode serial transfer timing (during communication at different potential)**

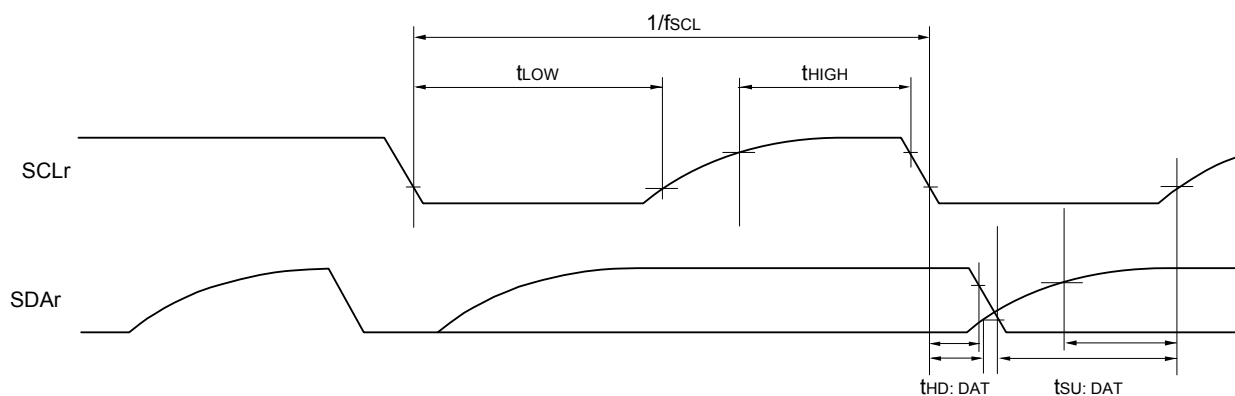

- Remark 1.**  $R_b[\Omega]$ : Communication line (SDAr, SCLr) pull-up resistance,  $C_b[F]$ : Communication line (SDAr, SCLr) load capacitance,  $V_b[V]$ : Communication line voltage
- Remark 2.** r: IIC number (r = 00, 01, 10, 11, 20), g: PIM, POM number (g = 0, 1, 3, 5, 7)
- Remark 3.**  $f_{mck}$ : Serial array unit operation clock frequency  
(Operation clock to be set by the CKSmn bit of serial mode register mn (SMRmn). m: Unit number (m = 0, 1), n: Channel number (n = 0, 2), mn = 00, 01, 02, 10)

## 2.5.2 Serial interface IICA

### (1) I<sup>2</sup>C standard mode

(TA = -40 to +85°C, 1.6 V ≤ EVDD0 ≤ VDD ≤ 5.5 V, VSS = EVSS0 = 0 V)

Parameter	Symbol	Conditions	HS (high-speed main) mode		LS (low-speed main) mode		LV (low-voltage main) mode		Unit	
			MIN.	MAX.	MIN.	MAX.	MIN.	MAX.		
SCLA0 clock frequency	f <sub>SCL</sub>	Standard mode: f <sub>CLK</sub> ≥ 1 MHz	2.7 V ≤ EVDD0 ≤ 5.5 V	0	100	0	100	0	100	kHz
			1.8 V ≤ EVDD0 ≤ 5.5 V	0	100	0	100	0	100	kHz
			1.7 V ≤ EVDD0 ≤ 5.5 V	0	100	0	100	0	100	kHz
			1.6 V ≤ EVDD0 ≤ 5.5 V	—		0	100	0	100	kHz
Setup time of restart condition	t <sub>SU: STA</sub>	2.7 V ≤ EVDD0 ≤ 5.5 V	4.7		4.7		4.7		μs	
		1.8 V ≤ EVDD0 ≤ 5.5 V	4.7		4.7		4.7		μs	
		1.7 V ≤ EVDD0 ≤ 5.5 V	4.7		4.7		4.7		μs	
		1.6 V ≤ EVDD0 ≤ 5.5 V	—		4.7		4.7		μs	
Hold time Note 1	t <sub>HD: STA</sub>	2.7 V ≤ EVDD0 ≤ 5.5 V	4.0		4.0		4.0		μs	
		1.8 V ≤ EVDD0 ≤ 5.5 V	4.0		4.0		4.0		μs	
		1.7 V ≤ EVDD0 ≤ 5.5 V	4.0		4.0		4.0		μs	
		1.6 V ≤ EVDD0 ≤ 5.5 V	—		4.0		4.0		μs	
Hold time when SCLA0 = "L"	t <sub>LOW</sub>	2.7 V ≤ EVDD0 ≤ 5.5 V	4.7		4.7		4.7		μs	
		1.8 V ≤ EVDD0 ≤ 5.5 V	4.7		4.7		4.7		μs	
		1.7 V ≤ EVDD0 ≤ 5.5 V	4.7		4.7		4.7		μs	
		1.6 V ≤ EVDD0 ≤ 5.5 V	—		4.7		4.7		μs	
Hold time when SCLA0 = "H"	t <sub>HIGH</sub>	2.7 V ≤ EVDD0 ≤ 5.5 V	4.0		4.0		4.0		μs	
		1.8 V ≤ EVDD0 ≤ 5.5 V	4.0		4.0		4.0		μs	
		1.7 V ≤ EVDD0 ≤ 5.5 V	4.0		4.0		4.0		μs	
		1.6 V ≤ EVDD0 ≤ 5.5 V	—		4.0		4.0		μs	

(Notes, Caution, and Remark are listed on the next page.)



**(1) I<sup>2</sup>C standard mode****(TA = -40 to +85°C, 1.6 V ≤ EVDD0 ≤ VDD ≤ 5.5 V, VSS = EVSS0 = 0 V)****(2/2)**

Parameter	Symbol	Conditions	HS (high-speed main) mode		LS (low-speed main) mode		LV (low-voltage main) mode		Unit
			MIN.	MAX.	MIN.	MAX.	MIN.	MAX.	
Data setup time (reception)	tsu: DAT	2.7 V ≤ EVDD0 ≤ 5.5 V	250		250		250		ns
		1.8 V ≤ EVDD0 ≤ 5.5 V	250		250		250		ns
		1.7 V ≤ EVDD0 ≤ 5.5 V	250		250		250		ns
		1.6 V ≤ EVDD0 ≤ 5.5 V	—		250		250		ns
Data hold time (transmission) Note 2	tHD: DAT	2.7 V ≤ EVDD0 ≤ 5.5 V	0	3.45	0	3.45	0	3.45	μs
		1.8 V ≤ EVDD0 ≤ 5.5 V	0	3.45	0	3.45	0	3.45	μs
		1.7 V ≤ EVDD0 ≤ 5.5 V	0	3.45	0	3.45	0	3.45	μs
		1.6 V ≤ EVDD0 ≤ 5.5 V	—		0	3.45	0	3.45	μs
Setup time of stop condition	tsu: STO	2.7 V ≤ EVDD0 ≤ 5.5 V	4.0		4.0		4.0		μs
		1.8 V ≤ EVDD0 ≤ 5.5 V	4.0		4.0		4.0		μs
		1.7 V ≤ EVDD0 ≤ 5.5 V	4.0		4.0		4.0		μs
		1.6 V ≤ EVDD0 ≤ 5.5 V	—		4.0		4.0		μs
Bus-free time	tBUF	2.7 V ≤ EVDD0 ≤ 5.5 V	4.7		4.7		4.7		μs
		1.8 V ≤ EVDD0 ≤ 5.5 V	4.7		4.7		4.7		μs
		1.7 V ≤ EVDD0 ≤ 5.5 V	4.7		4.7		4.7		μs
		1.6 V ≤ EVDD0 ≤ 5.5 V	—		4.7		4.7		μs

**Note 1.** The first clock pulse is generated after this period when the start/restart condition is detected.

**Note 2.** The maximum value (MAX.) of tHD: DAT is during normal transfer and a wait state is inserted in the ACK (acknowledge) timing.

**Caution** The values in the above table are applied even when bit 2 (PIOR02) in the peripheral I/O redirection register 0 (PIOR0) is 1. At this time, the pin characteristics (IOH1, IOL1, VOH1, VOL1) must satisfy the values in the redirect destination.

**Remark** The maximum value of C<sub>b</sub> (communication line capacitance) and the value of R<sub>b</sub> (communication line pull-up resistor) at that time in each mode are as follows.

Standard mode: C<sub>b</sub> = 400 pF, R<sub>b</sub> = 2.7 kΩ

(2) I<sup>2</sup>C fast mode

(TA = -40 to +85°C, 1.6 V ≤ EVDD0 ≤ VDD ≤ 5.5 V, VSS = EVSS0 = 0 V)

Parameter	Symbol	Conditions	HS (high-speed main) mode		LS (low-speed main) mode		LV (low-voltage main) mode		Unit	
			MIN.	MAX.	MIN.	MAX.	MIN.	MAX.		
SCLA0 clock frequency	fSCL	Fast mode: fCLK ≥ 3.5 MHz	2.7 V ≤ EVDD0 ≤ 5.5 V	0	400	0	400	0	400	kHz
			1.8 V ≤ EVDD0 ≤ 5.5 V	0	400	0	400	0	400	kHz
Setup time of restart condition	tsu: STA	2.7 V ≤ EVDD0 ≤ 5.5 V	0.6		0.6		0.6		μs	
		1.8 V ≤ EVDD0 ≤ 5.5 V	0.6		0.6		0.6		μs	
Hold time <sup>Note 1</sup>	tHD: STA	2.7 V ≤ EVDD0 ≤ 5.5 V	0.6		0.6		0.6		μs	
		1.8 V ≤ EVDD0 ≤ 5.5 V	0.6		0.6		0.6		μs	
Hold time when SCLA0 = "L"	tLOW	2.7 V ≤ EVDD0 ≤ 5.5 V	1.3		1.3		1.3		μs	
		1.8 V ≤ EVDD0 ≤ 5.5 V	1.3		1.3		1.3		μs	
Hold time when SCLA0 = "H"	tHIGH	2.7 V ≤ EVDD0 ≤ 5.5 V	0.6		0.6		0.6		μs	
		1.8 V ≤ EVDD0 ≤ 5.5 V	0.6		0.6		0.6		μs	
Data setup time (reception)	tsu: DAT	2.7 V ≤ EVDD0 ≤ 5.5 V	100		100		100		ns	
		1.8 V ≤ EVDD0 ≤ 5.5 V	100		100		100		ns	
Data hold time (transmission) <sup>Note 2</sup>	tHD: DAT	2.7 V ≤ EVDD0 ≤ 5.5 V	0	0.9	0	0.9	0	0.9	μs	
		1.8 V ≤ EVDD0 ≤ 5.5 V	0	0.9	0	0.9	0	0.9	μs	
Setup time of stop condition	tsu: STO	2.7 V ≤ EVDD0 ≤ 5.5 V	0.6		0.6		0.6		μs	
		1.8 V ≤ EVDD0 ≤ 5.5 V	0.6		0.6		0.6		μs	
Bus-free time	tBUF	2.7 V ≤ EVDD0 ≤ 5.5 V	1.3		1.3		1.3		μs	
		1.8 V ≤ EVDD0 ≤ 5.5 V	1.3		1.3		1.3		μs	

**Note 1.** The first clock pulse is generated after this period when the start/restart condition is detected.

**Note 2.** The maximum value (MAX.) of tHD: DAT is during normal transfer and a wait state is inserted in the ACK (acknowledge) timing.

**Caution** The values in the above table are applied even when bit 2 (PIOR02) in the peripheral I/O redirection register 0 (PIOR0) is 1. At this time, the pin characteristics (IOH1, IOL1, VOH1, VOL1) must satisfy the values in the redirect destination.

**Remark** The maximum value of C<sub>b</sub> (communication line capacitance) and the value of R<sub>b</sub> (communication line pull-up resistor) at that time in each mode are as follows.

Fast mode: C<sub>b</sub> = 320 pF, R<sub>b</sub> = 1.1 kΩ

**(3) I<sup>2</sup>C fast mode plus**

(TA = -40 to +85°C, 1.6 V ≤ EVDD0 ≤ VDD ≤ 5.5 V, VSS = EVSS0 = 0 V)

Parameter	Symbol	Conditions	HS (high-speed main) mode		LS (low-speed main) mode		LV (low-voltage main) mode		Unit
			MIN.	MAX.	MIN.	MAX.	MIN.	MAX.	
SCLA0 clock frequency	fSCL	Fast mode plus: fCLK ≥ 10 MHz 2.7 V ≤ EVDD0 ≤ 5.5 V	0	1000	—	—	—	—	kHz
Setup time of restart condition	tSU: STA	2.7 V ≤ EVDD0 ≤ 5.5 V	0.26		—	—	—	—	μs
Hold time Note 1	tHD: STA	2.7 V ≤ EVDD0 ≤ 5.5 V	0.26		—	—	—	—	μs
Hold time when SCLA0 = "L"	tLOW	2.7 V ≤ EVDD0 ≤ 5.5 V	0.5		—	—	—	—	μs
Hold time when SCLA0 = "H"	tHIGH	2.7 V ≤ EVDD0 ≤ 5.5 V	0.26		—	—	—	—	μs
Data setup time (reception)	tSU: DAT	2.7 V ≤ EVDD0 ≤ 5.5 V	50		—	—	—	—	ns
Data hold time (transmission) Note 2	tHD: DAT	2.7 V ≤ EVDD0 ≤ 5.5 V	0	0.45	—	—	—	—	μs
Setup time of stop condition	tSU: STO	2.7 V ≤ EVDD0 ≤ 5.5 V	0.26		—	—	—	—	μs
Bus-free time	tBUF	2.7 V ≤ EVDD0 ≤ 5.5 V	0.5		—	—	—	—	μs

**Note 1.** The first clock pulse is generated after this period when the start/restart condition is detected.

**Note 2.** The maximum value (MAX.) of tHD: DAT is during normal transfer and a wait state is inserted in the ACK (acknowledge) timing.

**Caution** The values in the above table are applied even when bit 2 (PIOR02) in the peripheral I/O redirection register 0 (PIOR0) is 1. At this time, the pin characteristics (IOH1, IOL1, VOH1, VOL1) must satisfy the values in the redirect destination.

**Remark** The maximum value of Cb (communication line capacitance) and the value of Rb (communication line pull-up resistor) at that time in each mode are as follows.

Fast mode plus: Cb = 120 pF, Rb = 1.1 kΩ

**I<sup>2</sup>C serial transfer timing**

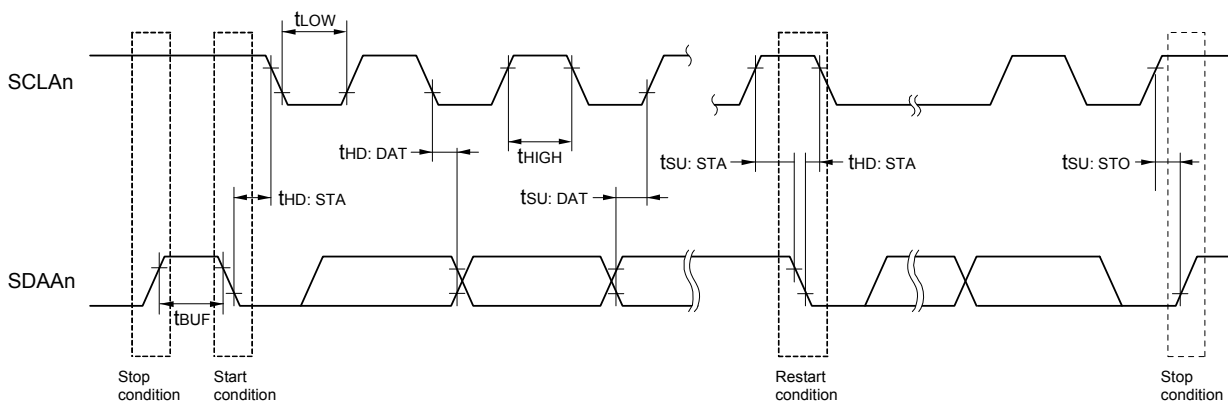

**Remark** n = 0, 1

## 2.6 Analog Characteristics

### 2.6.1 A/D converter characteristics

#### Classification of A/D converter characteristics

Input channel	Reference Voltage	Reference voltage (+) = AV <sub>REFP</sub> Reference voltage (-) = AV <sub>REFM</sub>	Reference voltage (+) = V <sub>DD</sub> Reference voltage (-) = V <sub>SS</sub>	Reference voltage (+) = V <sub>BGR</sub> Reference voltage (-) = AV <sub>REFM</sub>
ANI0 to ANI7		Refer to 2.6.1 (1).	Refer to 2.6.1 (3).	Refer to 2.6.1 (4).
ANI16 to ANI24		Refer to 2.6.1 (2).		
Internal reference voltage Temperature sensor output voltage		Refer to 2.6.1 (1).		

(1) When reference voltage (+) = AV<sub>REFP</sub>/ANI0 (ADREFP1 = 0, ADREFP0 = 1), reference voltage (-) = AV<sub>REFM</sub>/ANI1 (ADREFM = 1), target pin: ANI2 to ANI7, internal reference voltage, and temperature sensor output voltage

(TA = -40 to +85°C, 1.6 V ≤ AV<sub>REFP</sub> ≤ V<sub>DD</sub> ≤ 5.5 V, V<sub>SS</sub> = 0 V, Reference voltage (+) = AV<sub>REFP</sub>, Reference voltage (-) = AV<sub>REFM</sub> = 0 V)

Parameter	Symbol	Conditions	MIN.	TYP.	MAX.	Unit
Resolution	RES		8		10	bit
Overall error Note 1	AINL	10-bit resolution AV <sub>REFP</sub> = V <sub>DD</sub> Note 3	1.8 V ≤ AV <sub>REFP</sub> ≤ 5.5 V	1.2	±3.5	LSB
			1.6 V ≤ AV <sub>REFP</sub> ≤ 5.5 V Note 4	1.2	±7.0	LSB
Conversion time	t <sub>CONV</sub>	10-bit resolution Target pin: ANI2 to ANI14	3.6 V ≤ V <sub>DD</sub> ≤ 5.5 V	2.125	39	μs
			2.7 V ≤ V <sub>DD</sub> ≤ 5.5 V	3.1875	39	μs
			1.8 V ≤ V <sub>DD</sub> ≤ 5.5 V	17	39	μs
			1.6 V ≤ V <sub>DD</sub> ≤ 5.5 V	57	95	μs
		10-bit resolution Target pin: Internal reference voltage, and temperature sensor output voltage (HS (high-speed main) mode)	3.6 V ≤ V <sub>DD</sub> ≤ 5.5 V	2.375	39	μs
			2.7 V ≤ V <sub>DD</sub> ≤ 5.5 V	3.5625	39	μs
Zero-scale error Notes 1, 2	E <sub>ZS</sub>	10-bit resolution AV <sub>REFP</sub> = V <sub>DD</sub> Note 3	1.8 V ≤ AV <sub>REFP</sub> ≤ 5.5 V		±0.25	%FSR
			1.6 V ≤ AV <sub>REFP</sub> ≤ 5.5 V Note 4		±0.50	%FSR
Full-scale error Notes 1, 2	E <sub>FS</sub>	10-bit resolution AV <sub>REFP</sub> = V <sub>DD</sub> Note 3	1.8 V ≤ AV <sub>REFP</sub> ≤ 5.5 V		±0.25	%FSR
			1.6 V ≤ AV <sub>REFP</sub> ≤ 5.5 V Note 4		±0.50	%FSR
Integral linearity error Note 1	ILE	10-bit resolution AV <sub>REFP</sub> = V <sub>DD</sub> Note 3	1.8 V ≤ AV <sub>REFP</sub> ≤ 5.5 V		±2.5	LSB
			1.6 V ≤ AV <sub>REFP</sub> ≤ 5.5 V Note 4		±5.0	LSB
Differential linearity error Note 1	DLE	10-bit resolution AV <sub>REFP</sub> = V <sub>DD</sub> Note 3	1.8 V ≤ AV <sub>REFP</sub> ≤ 5.5 V		±1.5	LSB
			1.6 V ≤ AV <sub>REFP</sub> ≤ 5.5 V Note 4		±2.0	LSB
Analog input voltage	V <sub>AIN</sub>	ANI2 to ANI7	0		AV <sub>REFP</sub>	V
		Internal reference voltage (2.4 V ≤ V <sub>DD</sub> ≤ 5.5 V, HS (high-speed main) mode)			V <sub>BGR</sub> Note 5	V
		Temperature sensor output voltage (2.4 V ≤ V <sub>DD</sub> ≤ 5.5 V, HS (high-speed main) mode)			V <sub>TMPS25</sub> Note 5	V

**Note 1.** Excludes quantization error (±1/2 LSB).

**Note 2.** This value is indicated as a ratio (%FSR) to the full-scale value.

**Note 3.** When AV<sub>REFP</sub> < V<sub>DD</sub>, the MAX. values are as follows.

Overall error: Add ±1.0 LSB to the MAX. value when AV<sub>REFP</sub> = V<sub>DD</sub>.  
 Zero-scale error/Full-scale error: Add ±0.05%FSR to the MAX. value when AV<sub>REFP</sub> = V<sub>DD</sub>.  
 Integral linearity error/ Differential linearity error: Add ±0.5 LSB to the MAX. value when AV<sub>REFP</sub> = V<sub>DD</sub>.

**Note 4.** Values when the conversion time is set to 57 μs (min.) and 95 μs (max.).

**Note 5.** Refer to 2.6.2 Temperature sensor characteristics/internal reference voltage characteristic.

(2) When reference voltage (+) =  $AV_{REFP}/ANI0$  ( $ADREFP1 = 0$ ,  $ADREFP0 = 1$ ), reference voltage (-) =  $AV_{REFM}/ANI1$  ( $ADREFM = 1$ ), target pin: ANI16 to ANI24

(TA = -40 to +85°C,  $1.6\text{ V} \leq EV_{DD0} \leq V_{DD} \leq 5.5\text{ V}$ ,  $1.6\text{ V} \leq AV_{REFP} \leq V_{DD} \leq 5.5\text{ V}$ ,  $V_{SS} = EV_{SS0} = 0\text{ V}$ , Reference voltage (+) =  $AV_{REFP}$ , Reference voltage (-) =  $AV_{REFM} = 0\text{ V}$ )

Parameter	Symbol	Conditions	MIN.	TYP.	MAX.	Unit	
Resolution	RES		8		10	bit	
Overall error Note 1	AINL	10-bit resolution $EV_{DD0} \leq AV_{REFP} = V_{DD}$ Notes 3, 4	$1.8\text{ V} \leq AV_{REFP} \leq 5.5\text{ V}$		1.2	±5.0	LSB
			$1.6\text{ V} \leq AV_{REFP} \leq 5.5\text{ V}$ Note 5		1.2	±8.5	LSB
Conversion time	t <sub>CONV</sub>	10-bit resolution Target ANI pin: ANI16 to ANI24	$3.6\text{ V} \leq V_{DD} \leq 5.5\text{ V}$	2.125		39	μs
			$2.7\text{ V} \leq V_{DD} \leq 5.5\text{ V}$	3.1875		39	μs
			$1.8\text{ V} \leq V_{DD} \leq 5.5\text{ V}$		17	39	μs
			$1.6\text{ V} \leq V_{DD} \leq 5.5\text{ V}$		57	95	μs
Zero-scale error Notes 1, 2	E <sub>ZS</sub>	10-bit resolution $EV_{DD0} \leq AV_{REFP} = V_{DD}$ Notes 3, 4	$1.8\text{ V} \leq AV_{REFP} \leq 5.5\text{ V}$			±0.35	%FSR
			$1.6\text{ V} \leq AV_{REFP} \leq 5.5\text{ V}$ Note 5			±0.60	%FSR
Full-scale error Notes 1, 2	E <sub>FS</sub>	10-bit resolution $EV_{DD0} \leq AV_{REFP} = V_{DD}$ Notes 3, 4	$1.8\text{ V} \leq AV_{REFP} \leq 5.5\text{ V}$			±0.35	%FSR
			$1.6\text{ V} \leq AV_{REFP} \leq 5.5\text{ V}$ Note 5			±0.60	%FSR
Integral linearity error Note 1	ILE	10-bit resolution $EV_{DD0} \leq AV_{REFP} = V_{DD}$ Notes 3, 4	$1.8\text{ V} \leq AV_{REFP} \leq 5.5\text{ V}$			±3.5	LSB
			$1.6\text{ V} \leq AV_{REFP} \leq 5.5\text{ V}$ Note 5			±6.0	LSB
Differential linearity error Note 1	DLE	10-bit resolution $EV_{DD0} \leq AV_{REFP} = V_{DD}$ Notes 3, 4	$1.8\text{ V} \leq AV_{REFP} \leq 5.5\text{ V}$			±2.0	LSB
			$1.6\text{ V} \leq AV_{REFP} \leq 5.5\text{ V}$ Note 5			±2.5	LSB
Analog input voltage	V <sub>AIN</sub>	ANI16 to ANI24	0		$AV_{REFP}$ and $EV_{DD0}$	V	

**Note 1.** Excludes quantization error ( $\pm 1/2$  LSB).

**Note 2.** This value is indicated as a ratio (%FSR) to the full-scale value.

**Note 3.** When  $EV_{DD0} \leq AV_{REFP} \leq V_{DD}$ , the MAX. values are as follows.

Overall error: Add  $\pm 1.0$  LSB to the MAX. value when  $AV_{REFP} = V_{DD}$ .

Zero-scale error/Full-scale error: Add  $\pm 0.05\%$ FSR to the MAX. value when  $AV_{REFP} = V_{DD}$ .

Integral linearity error/ Differential linearity error: Add  $\pm 0.5$  LSB to the MAX. value when  $AV_{REFP} = V_{DD}$ .

**Note 4.** When  $AV_{REFP} < EV_{DD0} \leq V_{DD}$ , the MAX. values are as follows.

Overall error: Add  $\pm 4.0$  LSB to the MAX. value when  $AV_{REFP} = V_{DD}$ .

Zero-scale error/Full-scale error: Add  $\pm 0.20\%$ FSR to the MAX. value when  $AV_{REFP} = V_{DD}$ .

Integral linearity error/ Differential linearity error: Add  $\pm 2.0$  LSB to the MAX. value when  $AV_{REFP} = V_{DD}$ .

**Note 5.** When the conversion time is set to 57 μs (min.) and 95 μs (max.).

- (3) When reference voltage (+) = V<sub>DD</sub> (ADREFP1 = 0, ADREFP0 = 0), reference voltage (-) = V<sub>SS</sub> (ADREFM = 0), target pin: ANI0 to ANI17, ANI16 to ANI24, internal reference voltage, and temperature sensor output voltage

(TA = -40 to +85°C, 1.6 V ≤ EV<sub>DD0</sub> ≤ V<sub>DD</sub> ≤ 5.5 V, V<sub>SS</sub> = EV<sub>SS0</sub> = 0 V, Reference voltage (+) = V<sub>DD</sub>, Reference voltage (-) = V<sub>SS</sub>)

Parameter	Symbol	Conditions		MIN.	TYP.	MAX.	Unit
Resolution	RES			8		10	bit
Overall error Note 1	AINL	10-bit resolution	1.8 V ≤ V <sub>DD</sub> ≤ 5.5 V		1.2	±7.0	LSB
			1.6 V ≤ V <sub>DD</sub> ≤ 5.5 V Note 3		1.2	±10.5	LSB
Conversion time	t <sub>CONV</sub>	10-bit resolution Target pin: ANI0 to ANI7, ANI16 to ANI24	3.6 V ≤ V <sub>DD</sub> ≤ 5.5 V	2.125		39	μs
			2.7 V ≤ V <sub>DD</sub> ≤ 5.5 V	3.1875		39	μs
			1.8 V ≤ V <sub>DD</sub> ≤ 5.5 V	17		39	μs
			1.6 V ≤ V <sub>DD</sub> ≤ 5.5 V	57		95	μs
		10-bit resolution Target pin: internal reference voltage, and temperature sensor output voltage (HS (high-speed main) mode)	3.6 V ≤ V <sub>DD</sub> ≤ 5.5 V	2.375		39	μs
			2.7 V ≤ V <sub>DD</sub> ≤ 5.5 V	3.5625		39	μs
2.4 V ≤ V <sub>DD</sub> ≤ 5.5 V	17			39	μs		
Zero-scale error Notes 1, 2	E <sub>ZS</sub>	10-bit resolution	1.8 V ≤ V <sub>DD</sub> ≤ 5.5 V			±0.60	%FSR
			1.6 V ≤ V <sub>DD</sub> ≤ 5.5 V Note 3			±0.85	%FSR
Full-scale error Notes 1, 2	E <sub>FS</sub>	10-bit resolution	1.8 V ≤ V <sub>DD</sub> ≤ 5.5 V			±0.60	%FSR
			1.6 V ≤ V <sub>DD</sub> ≤ 5.5 V Note 3			±0.85	%FSR
Integral linearity error Note 1	ILE	10-bit resolution	1.8 V ≤ V <sub>DD</sub> ≤ 5.5 V			±4.0	LSB
			1.6 V ≤ V <sub>DD</sub> ≤ 5.5 V Note 3			±6.5	LSB
Differential linearity error Note 1	DLE	10-bit resolution	1.8 V ≤ V <sub>DD</sub> ≤ 5.5 V			±2.0	LSB
			1.6 V ≤ V <sub>DD</sub> ≤ 5.5 V Note 3			±2.5	LSB
Analog input voltage	V <sub>AIN</sub>	ANI0 to ANI7		0		V <sub>DD</sub>	V
		ANI16 to ANI24		0		EV <sub>DD0</sub>	V
		Internal reference voltage (2.4 V ≤ V <sub>DD</sub> ≤ 5.5 V, HS (high-speed main) mode)				V <sub>BGR</sub> Note 4	V
		Temperature sensor output voltage (2.4 V ≤ V <sub>DD</sub> ≤ 5.5 V, HS (high-speed main) mode)				V <sub>TMPS25</sub> Note 4	V

**Note 1.** Excludes quantization error (±1/2 LSB).

**Note 2.** This value is indicated as a ratio (% FSR) to the full-scale value.

**Note 3.** When the conversion time is set to 57 μs (min.) and 95 μs (max.).

**Note 4.** Refer to 2.6.2 Temperature sensor characteristics/internal reference voltage characteristic.

(4) When reference voltage (+) = Internal reference voltage (ADREFP1 = 1, ADREFP0 = 0), reference voltage (-) = AVREFM/ANI1 (ADREFM = 1), target pin: ANI0, ANI2 to ANI7, ANI16 to ANI24

(TA = -40 to +85°C, 2.4 V ≤ VDD ≤ 5.5 V, 1.6 V ≤ EVDD0 ≤ VDD, VSS = EVSS0 = 0 V, Reference voltage (+) = VBGR Note 3, Reference voltage (-) = AVREFM = 0 V Note 4, HS (high-speed main) mode)

Parameter	Symbol	Conditions		MIN.	TYP.	MAX.	Unit
Resolution	RES			8			bit
Conversion time	tCONV	8-bit resolution	2.4 V ≤ VDD ≤ 5.5 V	17		39	μs
Zero-scale error Notes 1, 2	Ezs	8-bit resolution	2.4 V ≤ VDD ≤ 5.5 V			±0.60	% FSR
Integral linearity error Note 1	ILE	8-bit resolution	2.4 V ≤ VDD ≤ 5.5 V			±2.0	LSB
Differential linearity error Note 1	DLE	8-bit resolution	2.4 V ≤ VDD ≤ 5.5 V			±1.0	LSB
Analog input voltage	VAIN			0		VBGR Note 3	V

**Note 1.** Excludes quantization error (±1/2 LSB).

**Note 2.** This value is indicated as a ratio (% FSR) to the full-scale value.

**Note 3.** Refer to **2.6.2 Temperature sensor characteristics/internal reference voltage characteristic**.

**Note 4.** When reference voltage (-) = VSS, the MAX. values are as follows.

Zero-scale error: Add ±0.35%FSR to the MAX. value when reference voltage (-) = AVREFM.

Integral linearity error: Add ±0.5 LSB to the MAX. value when reference voltage (-) = AVREFM.

Differential linearity error: Add ±0.2 LSB to the MAX. value when reference voltage (-) = AVREFM.

## 2.6.2 Temperature sensor characteristics/internal reference voltage characteristic

(TA = -40 to +85°C, 2.4 V ≤ VDD ≤ 5.5 V, VSS = EVSS0 = 0 V, HS (high-speed main) mode)

Parameter	Symbol	Conditions	MIN.	TYP.	MAX.	Unit
Temperature sensor output voltage	VTMPS25	Setting ADS register = 80H, TA = +25°C		1.05		V
Internal reference voltage	VBGR	Setting ADS register = 81H	1.38	1.45	1.5	V
Temperature coefficient	FVTMPS	Temperature sensor that depends on the temperature		-3.6		mV/°C
Operation stabilization wait time	tAMP		5			μs

## 2.6.3 D/A converter characteristics

(TA = -40 to +85°C, 1.6 V ≤ EVSS0 ≤ VDD ≤ 5.5 V, VSS = EVSS0 = 0 V)

Parameter	Symbol	Conditions		MIN.	TYP.	MAX.	Unit
Resolution	RES					8	bit
Overall error	AINL	Rload = 4 MΩ	1.8 V ≤ VDD ≤ 5.5 V			±2.5	LSB
		Rload = 8 MΩ	1.8 V ≤ VDD ≤ 5.5 V			±2.5	LSB
Settling time	tSET	Cload = 20 pF	2.7 V ≤ VDD ≤ 5.5 V			3	μs
			1.6 V ≤ VDD < 2.7 V			6	μs



## 2.6.4 Comparator

(TA = -40 to +85°C, 2.7 V ≤ VDD ≤ 5.5 V, VSS = 0 V)

Parameter	Symbol	Conditions	MIN.	TYP.	MAX.	Unit
Input offset voltage	V <sub>IOCOMP</sub>			±5	±40	mV
Input voltage range	V <sub>ICMP</sub>		0		V <sub>DD</sub>	V
Internal reference voltage deviation	ΔV <sub>IREF</sub>	CmRVM register value : 7FH to 80H (m = 0, 1)			±2	LSB
		Other than above			±1	LSB
Response Time	t <sub>CR</sub> , t <sub>CF</sub>	Input amplitude±100mV		70	150	ns
Operation stabilization time <sup>Note 1</sup>	t <sub>CMP</sub>	CMPn = 0→1	V <sub>DD</sub> = 3.3 to 5.5 V		1	μs
			V <sub>DD</sub> = 2.7 to 3.3 V		3	μs
Reference voltage stabilization wait time	t <sub>VR</sub>	CVRE : 0→1 <sup>Note 2</sup>			20	μs
Operation current	I <sub>COMPDD</sub>	Separately, it is defined as the operation current of peripheral functions.				

**Note 1.** Time taken until the comparator satisfies the DC/AC characteristics after the comparator operation enable signal is switched (CMPnEN = 0 → 1).

**Note 2.** Enable comparator output (CnOE bit = 1; n = 0 to 1) after enabling operation of the internal reference voltage generator (by setting the CVREm bit to 1; m = 0 to 1) and waiting for the operation stabilization time to elapse.

## 2.6.5 PGA

(TA = -40 to +85°C, 2.7 V ≤ VDD ≤ 5.5 V, VSS = 0 V)

Parameter	Symbol	Conditions	MIN.	TYP.	MAX.	Unit
Input offset voltage	V <sub>IOPGA</sub>				±10	mV
Input voltage range	V <sub>IPGA</sub>		0		0.9 × V <sub>DD</sub> /Gain	V
Output voltage range	V <sub>IOHPGA</sub>		0.93 × V <sub>DD</sub>			V
	V <sub>IOLPGA</sub>				0.07 × V <sub>DD</sub>	V
Gain error		x4, x8			±1	%
		x16			±1.5	%
		x32			±2	%
Slew rate	SR <sub>RPGA</sub>	Rising When Vin = 0.1V <sub>DD</sub> /gain to 0.9V <sub>DD</sub> /gain. 10 to 90% of output voltage amplitude	4.0 V ≤ V <sub>DD</sub> ≤ 5.5 V (Other than x32)	3.5		V/μs
			4.0 V ≤ V <sub>DD</sub> ≤ 5.5 V (x32)	3.0		
			2.7 V ≤ V <sub>DD</sub> ≤ 4.0V	0.5		
	SR <sub>FPGA</sub>	Falling When Vin = 0.1V <sub>DD</sub> /gain to 0.9V <sub>DD</sub> /gain. 90 to 10% of output voltage amplitude	4.0 V ≤ V <sub>DD</sub> ≤ 5.5 V (Other than x32)	3.5		
			4.0 V ≤ V <sub>DD</sub> ≤ 5.5 V (x32)	3.0		
			2.7 V ≤ V <sub>DD</sub> ≤ 4.0V	0.5		
Reference voltage stabilization wait time- Note 1	t <sub>PGA</sub>	x4, x8			5	μs
		x16, x32			10	μs
Operation current	I <sub>PGADD</sub>	Separately, it is defined as the operation current of peripheral functions.				

**Note 1.** Time required until a state is entered where the DC and AC specifications of the PGA are satisfied after the PGA operation has been enabled (PGAEN = 1).

### 2.6.6 POR circuit characteristics

(TA = -40 to +85°C, VSS = 0 V)

Parameter	Symbol	Conditions	MIN.	TYP.	MAX.	Unit
Power on/down reset threshold	V <sub>POR</sub>	Voltage threshold on V <sub>DD</sub> rising	1.47	1.51	1.55	V
	V <sub>PDR</sub>	Voltage threshold on V <sub>DD</sub> falling <sup>Note 1</sup>	1.46	1.50	1.54	V
Minimum pulse width <sup>Note 2</sup>	T <sub>PW</sub>		300			μs

**Note 1.** However, when the operating voltage falls while the LVD is off, enter STOP mode, or enable the reset status using the external reset pin before the voltage falls below the operating voltage range shown in **2.4 AC Characteristics**.

**Note 2.** Minimum time required for a POR reset when V<sub>DD</sub> exceeds below V<sub>PDR</sub>. This is also the minimum time required for a POR reset from when V<sub>DD</sub> exceeds below 0.7 V to when V<sub>DD</sub> exceeds V<sub>POR</sub> while STOP mode is entered or the main system clock is stopped through setting bit 0 (HIOS<sub>STOP</sub>) and bit 7 (MSTOP) in the clock operation status control register (CSC).

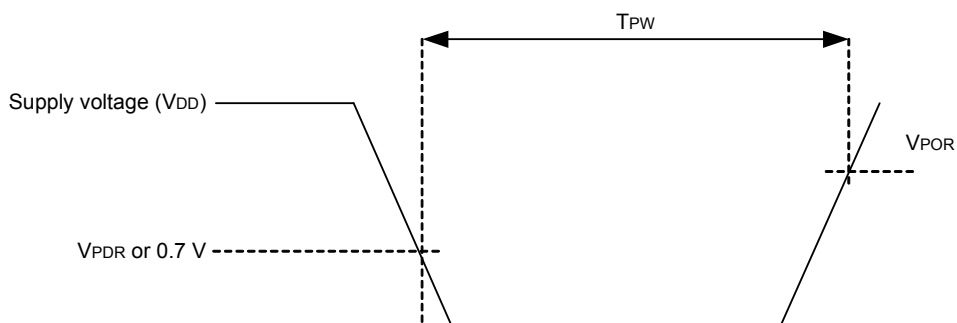

## 2.6.7 LVD circuit characteristics

### (1) Reset Mode and Interrupt Mode

(TA = -40 to +85°C, VPDR ≤ EVDD0 ≤ VDD ≤ 5.5 V, VSS = EVSS0 = 0 V)

Parameter		Symbol	Conditions	MIN.	TYP.	MAX.	Unit
Voltage detection threshold	Supply voltage level	VLVD0	Rising edge	3.98	4.06	4.14	V
			Falling edge	3.90	3.98	4.06	V
		VLVD1	Rising edge	3.68	3.75	3.82	V
			Falling edge	3.60	3.67	3.74	V
		VLVD2	Rising edge	3.07	3.13	3.19	V
			Falling edge	3.00	3.06	3.12	V
		VLVD3	Rising edge	2.96	3.02	3.08	V
			Falling edge	2.90	2.96	3.02	V
		VLVD4	Rising edge	2.86	2.92	2.97	V
			Falling edge	2.80	2.86	2.91	V
		VLVD5	Rising edge	2.76	2.81	2.87	V
			Falling edge	2.70	2.75	2.81	V
		VLVD6	Rising edge	2.66	2.71	2.76	V
			Falling edge	2.60	2.65	2.70	V
		VLVD7	Rising edge	2.56	2.61	2.66	V
			Falling edge	2.50	2.55	2.60	V
		VLVD8	Rising edge	2.45	2.50	2.55	V
			Falling edge	2.40	2.45	2.50	V
		VLVD9	Rising edge	2.05	2.09	2.13	V
			Falling edge	2.00	2.04	2.08	V
		VLVD10	Rising edge	1.94	1.98	2.02	V
			Falling edge	1.90	1.94	1.98	V
		VLVD11	Rising edge	1.84	1.88	1.91	V
			Falling edge	1.80	1.84	1.87	V
		VLVD12	Rising edge	1.74	1.77	1.81	V
			Falling edge	1.70	1.73	1.77	V
VLVD13	Rising edge	1.64	1.67	1.70	V		
	Falling edge	1.60	1.63	1.66	V		
Minimum pulse width		tLW		300			μs
Detection delay time						300	μs

**(2) Interrupt & Reset Mode****(TA = -40 to +85°C, VPDR ≤ EVDD0 ≤ VDD ≤ 5.5 V, VSS = EVSS0 = 0 V)**

Parameter	Symbol	Conditions	MIN.	TYP.	MAX.	Unit	
Voltage detection threshold	VLVDA0	VPOC2, VPOC1, VPOC0 = 0, 0, 0, falling reset voltage	1.60	1.63	1.66	V	
	VLVDA1	LVIS1, LVIS0 = 1, 0	Rising release reset voltage	1.74	1.77	1.81	V
			Falling interrupt voltage	1.70	1.73	1.77	V
	VLVDA2	LVIS1, LVIS0 = 0, 1	Rising release reset voltage	1.84	1.88	1.91	V
			Falling interrupt voltage	1.80	1.84	1.87	V
	VLVDA3	LVIS1, LVIS0 = 0, 0	Rising release reset voltage	2.86	2.92	2.97	V
			Falling interrupt voltage	2.80	2.86	2.91	V
	VLVDB0	VPOC2, VPOC1, VPOC0 = 0, 0, 1, falling reset voltage	1.80	1.84	1.87	V	
	VLVDB1	LVIS1, LVIS0 = 1, 0	Rising release reset voltage	1.94	1.98	2.02	V
			Falling interrupt voltage	1.90	1.94	1.98	V
	VLVDB2	LVIS1, LVIS0 = 0, 1	Rising release reset voltage	2.05	2.09	2.13	V
			Falling interrupt voltage	2.00	2.04	2.08	V
VLVDB3	LVIS1, LVIS0 = 0, 0	Rising release reset voltage	3.07	3.13	3.19	V	
		Falling interrupt voltage	3.00	3.06	3.12	V	
VLVDC0	VPOC2, VPOC1, VPOC0 = 0, 1, 0, falling reset voltage	2.40	2.45	2.50	V		
VLVDC1	LVIS1, LVIS0 = 1, 0	Rising release reset voltage	2.56	2.61	2.66	V	
		Falling interrupt voltage	2.50	2.55	2.60	V	
VLVDC2	LVIS1, LVIS0 = 0, 1	Rising release reset voltage	2.66	2.71	2.76	V	
		Falling interrupt voltage	2.60	2.65	2.70	V	
VLVDC3	LVIS1, LVIS0 = 0, 0	Rising release reset voltage	3.68	3.75	3.82	V	
		Falling interrupt voltage	3.60	3.67	3.74	V	
VLVDD0	VPOC2, VPOC1, VPOC0 = 0, 1, 1, falling reset voltage	2.70	2.75	2.81	V		
VLVDD1	LVIS1, LVIS0 = 1, 0	Rising release reset voltage	2.86	2.92	2.97	V	
		Falling interrupt voltage	2.80	2.86	2.91	V	
VLVDD2	LVIS1, LVIS0 = 0, 1	Rising release reset voltage	2.96	3.02	3.08	V	
		Falling interrupt voltage	2.90	2.96	3.02	V	
VLVDD3	LVIS1, LVIS0 = 0, 0	Rising release reset voltage	3.98	4.06	4.14	V	
		Falling interrupt voltage	3.90	3.98	4.06	V	

**2.6.8 Power supply voltage rising slope characteristics****(TA = -40 to +85°C, VSS = 0 V)**

Parameter	Symbol	Conditions	MIN.	TYP.	MAX.	Unit
Power supply voltage rising slope	SVDD				54	V/ms

**Caution** Make sure to keep the internal reset state by the LVD circuit or an external reset until VDD reaches the operating voltage range shown in 2.4 AC Characteristics.

## 2.7 RAM Data Retention Characteristics

(TA = -40 to +85°C, Vss = 0V)

Parameter	Symbol	Conditions	MIN.	TYP.	MAX.	Unit
Data retention supply voltage	VDDDR		1.46 Notes 1, 2		5.5	V

**Note 1.** The value depends on the POR detection voltage. When the voltage drops, the RAM data is retained before a POR reset is effected, but RAM data is not retained when a POR reset is effected.

**Note 2.** Enter STOP mode before the supply voltage falls below the recommended operating voltage.

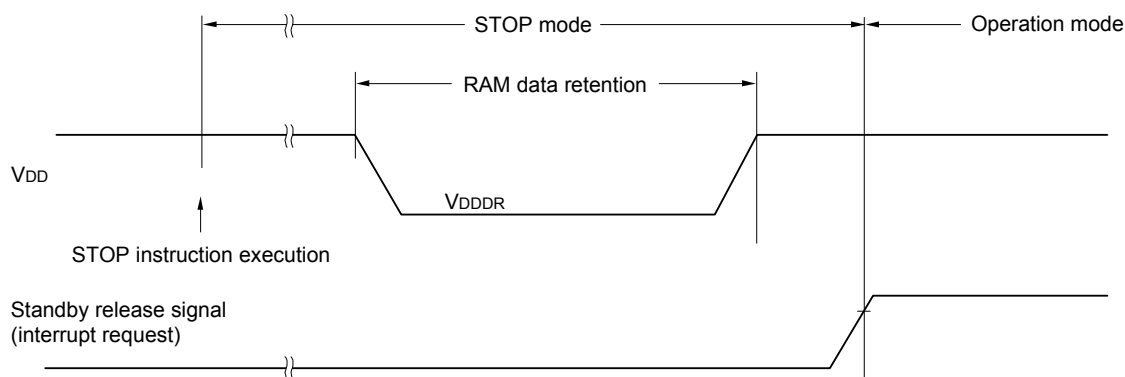

## 2.8 Flash Memory Programming Characteristics

(TA = -40 to +85°C, 1.8 V ≤ VDD ≤ 5.5 V, Vss = 0 V)

Parameter	Symbol	Conditions		MIN.	TYP.	MAX.	Unit
System clock frequency	fCLK	1.8 V ≤ VDD ≤ 5.5 V		1		32	MHz
Number of code flash rewrites Notes 1, 2, 3	C <sub>erwr</sub>	Retained for 20 years	TA = 85°C	1,000			Times
		Retained for 1 year	TA = 25°C		1,000,000		
Number of data flash rewrites Notes 1, 2, 3		Retained for 5 years	TA = 85°C	100,000			
		Retained for 20 years	TA = 85°C	10,000			

**Note 1.** 1 erase + 1 write after the erase is regarded as 1 rewrite. The retaining years are until next rewrite after the rewrite.

**Note 2.** When using flash memory programmer and Renesas Electronics self-programming library

**Note 3.** These are the characteristics of the flash memory and the results obtained from reliability testing by Renesas Electronics Corporation.

## 2.9 Dedicated Flash Memory Programmer Communication (UART)

(TA = -40 to +85°C, 1.8 V ≤ EVDD0 ≤ VDD ≤ 5.5 V, Vss = EVSS0 = 0 V)

Parameter	Symbol	Conditions	MIN.	TYP.	MAX.	Unit
Transfer rate		During serial programming	115,200		1,000,000	bps

## 2.10 Timing of Entry to Flash Memory Programming Modes

(TA = -40 to +85°C, 1.8 V ≤ EVDD0 ≤ VDD ≤ 5.5 V, VSS = EVSS0 = 0 V)

Parameter	Symbol	Conditions	MIN.	TYP.	MAX.	Unit
How long from when an external reset ends until the initial communication settings are specified	tsuINIT	POR and LVD reset must end before the external reset ends.			100	ms
How long from when the TOOL0 pin is placed at the low level until an external reset ends	tsu	POR and LVD reset must end before the external reset ends.	10			μs
How long the TOOL0 pin must be kept at the low level after an external reset ends (excluding the processing time of the firmware to control the flash memory)	tHD	POR and LVD reset must end before the external reset ends.	1			ms

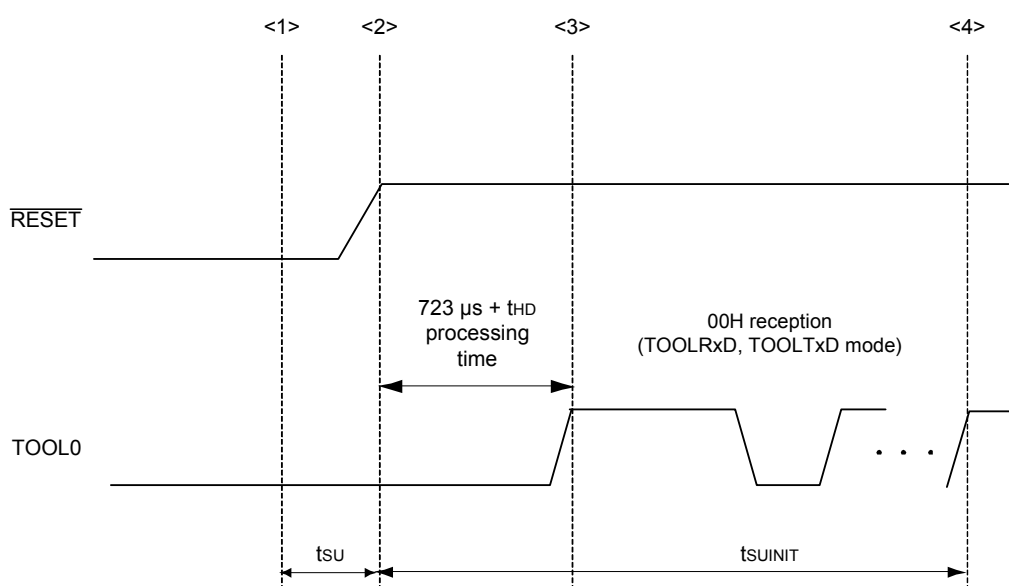

- <1> The low level is input to the TOOL0 pin.
- <2> The external reset ends (POR and LVD reset must end before the external reset ends).
- <3> The TOOL0 pin is set to the high level.
- <4> Setting of the flash memory programming mode by UART reception and complete the baud rate setting.

tsuINIT: The segment shows that it is necessary to finish specifying the initial communication settings within 100 ms from when the external resets end.

tsu: How long from when the TOOL0 pin is placed at the low level until a pin reset ends

tHD: How long to keep the TOOL0 pin at the low level from when the external resets end (excluding the processing time of the firmware to control the flash memory)

### 3. ELECTRICAL SPECIFICATIONS (G: TA = -40 to +105°C)

This chapter describes the following electrical specifications.

Target products G: Industrial applications TA = -40 to +105°C  
R5F11BxxGxx

**Caution 1.** The RL78 microcontrollers have an on-chip debug function, which is provided for development and evaluation. Do not use the on-chip debug function in products designated for mass production, because the guaranteed number of rewritable times of the flash memory may be exceeded when this function is used, and product reliability therefore cannot be guaranteed. Renesas Electronics is not liable for problems occurring when the on-chip debug function is used.

**Caution 2.** With products not provided with an EVDD0, or EVSS0 pin, replace EVDD0 with VDD, or replace EVSS0 with VSS.

**Caution 3.** The pins mounted depend on the product. Refer to 2.1 Port Functions to 2.2.1 Functions for each product in the RL78/G1F User's Manual.

**Caution 4.** Please contact Renesas Electronics sales office for derating of operation under TA = +85 to +105°C. Derating is the systematic reduction of load for the sake of improved reliability.

**Remark** When the products "G: Industrial applications" is used in the range of TA = -40 to +85°C, see 2. ELECTRICAL SPECIFICATIONS (TA = -40 to +85°C).

Operation of products rated “G: Industrial applications (TA = -40 to + 105°C)” at ambient operating temperatures above 85°C differs from that of products rated “A: Consumer applications” in the ways listed below.

Parameter	A: Consumer applications	G: Industrial applications
Operating ambient temperature	TA = -40 to +85°C	TA = -40 to +105°C
Operating mode Operating voltage range	HS (high-speed main) mode: 2.7 V ≤ V <sub>DD</sub> ≤ 5.5 V@1 MHz to 32 MHz 2.4 V ≤ V <sub>DD</sub> ≤ 5.5 V@1 MHz to 16 MHz LS (low-speed main) mode: 1.8 V ≤ V <sub>DD</sub> ≤ 5.5 V@1 MHz to 8 MHz LV (low-voltage main) mode: 2.4 V ≤ V <sub>DD</sub> ≤ 5.5 V@1 MHz to 4 MHz	HS (high-speed main) mode only: 2.7 V ≤ V <sub>DD</sub> ≤ 5.5 V@1 MHz to 32 MHz 2.4 V ≤ V <sub>DD</sub> ≤ 5.5 V@1 MHz to 16 MHz
High-speed on-chip oscillator clock accuracy	1.8 V ≤ V <sub>DD</sub> ≤ 5.5 V: ±1.0% @ TA = -20 to +85°C ±1.5% @ TA = -40 to -20°C 2.4 V ≤ V <sub>DD</sub> < 1.8 V: ±5.0% @ TA = -20 to +85°C ±5.5% @ TA = -40 to -20°C	2.4 V ≤ V <sub>DD</sub> ≤ 5.5 V: ±2.0% @ TA = +85 to +105°C ±1.0% @ TA = -20 to +85°C ±1.5% @ TA = -40 to -20°C
Serial array unit	UART CSI: f <sub>CLK</sub> /2 (16 Mbps supported), f <sub>CLK</sub> /4 Simplified I <sup>2</sup> C communication	UART CSI: f <sub>CLK</sub> /4 Simplified I <sup>2</sup> C communication
IICA	Standard mode Fast mode Fast mode plus	Standard mode Fast mode
Voltage detector	• Rising: 1.67 V to 4.06 V (14 stages) • Falling: 1.63 V to 3.98 V (14 stages)	• Rising: 2.61 V to 4.06 V (8 stages) • Falling: 2.55 V to 3.98 V (8 stages)

**Remark** The electrical characteristics of products rated “G: Industrial applications (TA = -40 to + 105°C)” at ambient operating temperatures above 85°C differ from those of products “A: Consumer applications”. For details, refer to 3.1 to 3.10.



### 3.1 Absolute Maximum Ratings

#### Absolute Maximum Ratings

(1/2)

Parameter	Symbols	Conditions	Ratings	Unit
Supply voltage	V <sub>DD</sub>		-0.5 to +6.5	V
	EV <sub>DD0</sub>		-0.5 to +6.5	V
REGC pin input voltage	V <sub>IREGC</sub>	REGC	-0.3 to +2.8 and -0.3 to V <sub>DD</sub> +0.3 Note 1	V
Input voltage	V <sub>I1</sub>	P00 to P06, P10 to P17, P30, P31, P40 to P43, P50 to P55, P70 to P77, P120, P140, P141, P146, P147	-0.3 to EV <sub>DD0</sub> +0.3 and -0.3 to V <sub>DD</sub> +0.3 Note 2	V
	V <sub>I2</sub>	P60 to P63 (N-ch open-drain)	-0.3 to +6.5	V
	V <sub>I3</sub>	P20 to P27, P121 to P124, P137, EXCLK, EXCLKS, RESET	-0.3 to V <sub>DD</sub> +0.3 Note 2	V
Output voltage	V <sub>O1</sub>	P00 to P06, P10 to P17, P30, P31, P40 to P43, P50 to P55, P60 to P63, P70 to P77, P120, P130, P140, P141, P146, P147	-0.3 to EV <sub>DD0</sub> +0.3 and -0.3 to V <sub>DD</sub> +0.3 Note 2	V
	V <sub>O2</sub>	P20 to P27	-0.3 to V <sub>DD</sub> +0.3 Note 2	V
Analog input voltage	V <sub>AI1</sub>	ANI16 to ANI24	-0.3 to EV <sub>DD0</sub> +0.3 and -0.3 to AV <sub>REF</sub> (+) +0.3 Notes 2, 3	V
	V <sub>AI2</sub>	ANI0 to ANI7	-0.3 to V <sub>DD</sub> +0.3 and -0.3 to AV <sub>REF</sub> (+) +0.3 Notes 2, 3	V

**Note 1.** Connect the REGC pin to V<sub>SS</sub> via a capacitor (0.47 to 1 μF). This value regulates the absolute maximum rating of the REGC pin. Do not use this pin with voltage applied to it.

**Note 2.** Must be 6.5 V or lower.

**Note 3.** Do not exceed AV<sub>REF</sub> (+) + 0.3 V in case of A/D conversion target pin.

**Caution** Product quality may suffer if the absolute maximum rating is exceeded even momentarily for any parameter. That is, the absolute maximum ratings are rated values at which the product is on the verge of suffering physical damage, and therefore the product must be used under conditions that ensure that the absolute maximum ratings are not exceeded.

**Remark 1.** Unless specified otherwise, the characteristics of alternate-function pins are the same as those of the port pins.

**Remark 2.** AV<sub>REF</sub> (+): + side reference voltage of the A/D converter.

**Remark 3.** V<sub>SS</sub>: Reference voltage

**Absolute Maximum Ratings****(2/2)**

Parameter	Symbols	Conditions		Ratings	Unit
Output current, high	IOH1	Per pin	P00 to P06, P10 to P17, P30, P31, P40 to P43, P50 to P55, P70 to P77, P120, P130, P140, P141, P146, P147	-40	mA
		Total of all pins -170 mA	P00 to P04, P40 to P43, P120, P130, P140, P141	-70	mA
			P05, P06, P10 to P17, P30, P31, P50 to P55, P70 to P77, P146, P147	-100	mA
	IOH2	Per pin	P20 to P27	-0.5	mA
		Total of all pins		-2	mA
	Output current, low	IOL1	Per pin	P00 to P06, P10 to P17, P30, P31, P40-P43, P50 to P55, P60 to P63, P70 to P77, P120, P130, P140, P141, P146, P147	40
Total of all pins 170 mA			P00 to P04, P40 to P47, P120, P130, P140, P141	70	mA
			P05, P06, P10 to P17, P30, P31, P50 to P55, P70 to P77, P146, P147	100	mA
IOL2		Per pin	P20 to P27	1	mA
		Total of all pins		5	mA
Operating ambient temperature		TA	In normal operation mode		-40 to +105
	In flash memory programming mode				
Storage temperature	Tstg			-65 to +150	°C

**Caution** Product quality may suffer if the absolute maximum rating is exceeded even momentarily for any parameter. That is, the absolute maximum ratings are rated values at which the product is on the verge of suffering physical damage, and therefore the product must be used under conditions that ensure that the absolute maximum ratings are not exceeded.

**Remark** Unless specified otherwise, the characteristics of alternate-function pins are the same as those of the port pins.

## 3.2 Oscillator Characteristics

### 3.2.1 X1, XT1 characteristics

(TA = -40 to +105°C, 2.4 V ≤ EVDD0 = VDD ≤ 5.5 V, VSS = 0 V)

Resonator	Resonator	Conditions	MIN.	TYP.	MAX.	Unit
X1 clock oscillation frequency (fX) <sup>Note</sup>	Ceramic resonator/ crystal resonator	2.7 V ≤ VDD ≤ 5.5 V	1.0		20.0	MHz
		2.4 V ≤ VDD < 2.7 V	1.0		16.0	
XT1 clock oscillation frequency (fXT) <sup>Note</sup>	Crystal resonator		32	32.768	35	kHz

**Note** Indicates only permissible oscillator frequency ranges. Refer to **AC Characteristics** for instruction execution time. Request evaluation by the manufacturer of the oscillator circuit mounted on a board to check the oscillator characteristics.

**Caution** Since the CPU is started by the high-speed on-chip oscillator clock after a reset release, check the X1 clock oscillation stabilization time using the oscillation stabilization time counter status register (OSTC) by the user. Determine the oscillation stabilization time of the OSTC register and the oscillation stabilization time select register (OSTS) after sufficiently evaluating the oscillation stabilization time with the resonator to be used.

**Remark** When using the X1 oscillator and XT1 oscillator, refer to 5.4 System Clock Oscillator in the RL78/G1F User's Manual.

### 3.2.2 On-chip oscillator characteristics

(TA = -40 to +105°C, 2.4 V ≤ EVDD0 = VDD ≤ 5.5 V, VSS = 0 V)

Oscillators	Parameters	Conditions	MIN.	TYP.	MAX.	Unit
High-speed on-chip oscillator clock frequency Notes 1, 2	f <sub>H</sub>	2.7 V ≤ VDD ≤ 5.5 V	1		32	MHz
		2.4 V ≤ VDD < 2.7 V	1		16	MHz
High-speed on-chip oscillator clock frequency accuracy		TA = +85 to +105°C	-2		2	%
		TA = -20 to +85°C	-1		1	%
		TA = -40 to -20°C	-1.5		1.5	%
Low-speed on-chip oscillator clock frequency	f <sub>L</sub>			15		kHz
Low-speed on-chip oscillator clock frequency accuracy			-15		+15	%

**Note 1.** High-speed on-chip oscillator frequency is selected with bits 0 to 4 of the option byte (000C2H/010C2H) and bits 0 to 2 of the HOCODIV register.

**Note 2.** This only indicates the oscillator characteristics. Refer to **AC Characteristics** for instruction execution time.

### 3.3 DC Characteristics

#### 3.3.1 Pin characteristics

(TA = -40 to +105°C, 2.4 V ≤ EVDD0 ≤ VDD ≤ 5.5 V, VSS = EVSS0 = 0 V)

Items	Symbol	Conditions	MIN.	TYP.	MAX.	Unit	
Output current, high <sup>Note 1</sup>	IOH1	Per pin for P00 to P06, P10 to P17, P30, P31, P40 to P47, P50 to P55, P70 to P77, P120, P130, P140, P141, P146, P147			-3.0 Note 2	mA	
		Total of P00 to P04, P40 to P43, P120, P130, P140, P141 (When duty ≤ 70% <sup>Note 3</sup> )	4.0 V ≤ EVDD0 ≤ 5.5 V		-30.0	mA	
			2.7 V ≤ EVDD0 < 4.0 V		-10.0	mA	
			2.4 V ≤ EVDD0 < 2.7 V		-5.0	mA	
		Total of P05, P06, P10 to P17, P30, P31, P50 to P53, P70 to P77, P146, P147 (When duty ≤ 70% <sup>Note 3</sup> )	4.0 V ≤ EVDD0 ≤ 5.5 V		-30.0	mA	
			2.7 V ≤ EVDD0 < 4.0 V		-19.0	mA	
	1.8 V ≤ EVDD0 < 2.7 V			-10.0	mA		
	Total of all pins (When duty ≤ 70% <sup>Note 3</sup> )				-60.0	mA	
	IOH2	Per pin for P20 to P27				-0.1 Note 2	mA
		Total of all pins (When duty ≤ 70% <sup>Note 3</sup> )	2.4 V ≤ VDD ≤ 5.5 V			-1.5	mA

**Note 1.** Value of current at which the device operation is guaranteed even if the current flows from the EVDD0, VDD pins to an output pin.

**Note 2.** Do not exceed the total current value.

**Note 3.** Specification under conditions where the duty factor ≤ 70%.

The output current value that has changed to the duty factor > 70% the duty ratio can be calculated with the following expression (when changing the duty factor from 70% to n%).

- Total output current of pins = (IOH × 0.7)/(n × 0.01)  
<Example> Where n = 80% and IOH = -10.0 mA  
Total output current of pins = (-10.0 × 0.7)/(80 × 0.01) ≈ -8.7 mA

However, the current that is allowed to flow into one pin does not vary depending on the duty factor.

A current higher than the absolute maximum rating must not flow into one pin.

**Caution** P00, P02 to P04, P10, P11, P13 to P15, P17, P30, P43, P50 to P55, P71, P74 do not output high level in N-ch open-drain mode.

**Remark** Unless specified otherwise, the characteristics of alternate-function pins are the same as those of the port pins.

(TA = -40 to +105°C, 2.4 V ≤ EVDD0 ≤ VDD ≤ 5.5 V, VSS = EVSS0 = 0 V)

(2/5)

Items	Symbol	Conditions	MIN.	TYP.	MAX.	Unit
Output current, low <sup>Note 1</sup>	IOL1	Per pin for P00 to P06, P10 to P17, P30, P31, P40 to P43, P50 to P55, P70 to P77, P120, P130, P140, P141, P146, P147			8.5 Note 2	mA
					15.0 Note 2	mA
		Total of P00 to P04, P40 to P43, P120, P130, P140, P141 (When duty ≤ 70% <sup>Note 3</sup> )	4.0 V ≤ EVDD0 ≤ 5.5 V		40.0	mA
			2.7 V ≤ EVDD0 < 4.0 V		15.0	mA
			2.4 V ≤ EVDD0 < 1.8 V		9.0	mA
		Total of P05, P06, P10 to P17, P30, P31, P50 to P55, P60 to P63, P70 to P77, P146, P147 (When duty ≤ 70% <sup>Note 3</sup> )	4.0 V ≤ EVDD0 ≤ 5.5 V		40.0	mA
			2.7 V ≤ EVDD0 < 4.0 V		35.0	mA
	2.4 V ≤ EVDD0 < 1.8 V			20.0	mA	
	Total of all pins (When duty ≤ 70% <sup>Note 3</sup> )			80.0	mA	
	IOL2	Per pin for P20 to P27			0.4 Note 2	mA
Total of all pins (When duty ≤ 70% <sup>Note 3</sup> )		2.4 V ≤ VDD ≤ 5.5 V		5.0	mA	

**Note 1.** Value of current at which the device operation is guaranteed even if the current flows from an output pin to the EVSS0 and VSS pins.

**Note 2.** Do not exceed the total current value.

**Note 3.** Specification under conditions where the duty factor ≤ 70%.

The output current value that has changed to the duty factor > 70% the duty ratio can be calculated with the following expression (when changing the duty factor from 70% to n%).

- Total output current of pins = (IOL × 0.7)/(n × 0.01)

<Example> Where n = 80% and IOL = 10.0 mA

$$\text{Total output current of pins} = (10.0 \times 0.7)/(80 \times 0.01) \approx 8.7 \text{ mA}$$

However, the current that is allowed to flow into one pin does not vary depending on the duty factor.

A current higher than the absolute maximum rating must not flow into one pin.

**Remark** Unless specified otherwise, the characteristics of alternate-function pins are the same as those of the port pins.

(TA = -40 to +105°C, 2.4 V ≤ EVDD0 ≤ VDD ≤ 5.5 V, VSS = EVSS0 = 0 V)

(3/5)

Items	Symbol	Conditions	MIN.	TYP.	MAX.	Unit	
Input voltage, high	V <sub>IH1</sub>	P00 to P06, P10 to P17, P30, P31, P40 to P43, P50 to P55, P70 to P77, P120, P140, P141, P146, P147	Normal input buffer	0.8 EVDD0		EVDD0	V
	V <sub>IH2</sub>	P01, P03, P04, P10, P14 to P17, P30, P43, P50, P53 to P55,	TTL input buffer 4.0 V ≤ EVDD0 ≤ 5.5 V	2.2		EVDD0	V
			TTL input buffer 3.3 V ≤ EVDD0 < 4.0 V	2.0		EVDD0	V
			TTL input buffer 2.4 V ≤ EVDD0 < 3.3 V	1.5		EVDD0	V
	V <sub>IH3</sub>	P20 to P27 (when P20 is used as a port pin)		0.7 VDD		VDD	V
	V <sub>IH4</sub>	P60 to P63		0.7 EVDD0		6.0	V
V <sub>IH5</sub>	P121 to P123, P137, EXCLK, EXCLKS, $\overline{\text{RESET}}$ (when P20 is used as INTP11 pin)		0.8 VDD		VDD	V	
Input voltage, low	V <sub>IL1</sub>	P00 to P06, P10 to P17, P30, P31, P40 to P43, P50 to P55, P70 to P77, P120, P140, P141, P146, P147	Normal input buffer	0		0.2 EVDD0	V
	V <sub>IL2</sub>	P01, P03, P04, P10, P14 to P17, P30, P43, P50, P53 to P55,	TTL input buffer 4.0 V ≤ EVDD0 ≤ 5.5 V	0		0.8	V
			TTL input buffer 3.3 V ≤ EVDD0 < 4.0 V	0		0.5	V
			TTL input buffer 2.4 V ≤ EVDD0 < 3.3 V	0		0.32	V
	V <sub>IL3</sub>	P20 to P27 (when P20 is used as a port pin)		0		0.3 VDD	V
	V <sub>IL4</sub>	P60 to P63		0		0.3 EVDD0	V
V <sub>IL5</sub>	P121 to P124, P137, EXCLK, EXCLKS, $\overline{\text{RESET}}$ (when P20 is used as INTP11 pin)		0		0.2 VDD	V	

**Caution** The maximum value of V<sub>IH</sub> of pins P00, P02 to P04, P10, P11, P13 to P15, P17, P30, P43, P50 to P55, P71, P74 is EVDD0, even in the N-ch open-drain mode.

**Remark** Unless specified otherwise, the characteristics of alternate-function pins are the same as those of the port pins.

(TA = -40 to +105°C, 2.4 V ≤ EVDD0 ≤ VDD ≤ 5.5 V, VSS = EVSS0 = 0 V)

(4/5)

Items	Symbol	Conditions	MIN.	TYP.	MAX.	Unit
Output voltage, high	VOH1	P00 to P06, P10 to P17, P30, P31, P40 to P43, P50 to P55, P70 to P77, P120, P130, P140, P141, P146, P147	4.0 V ≤ EVDD0 ≤ 5.5 V, IOH1 = -3.0 mA	EVDD0 - 0.7		V
			2.7 V ≤ EVDD0 ≤ 5.5 V, IOH1 = -2.0 mA	EVDD0 - 0.6		V
			2.4 V ≤ EVDD0 < 5.5 V, IOH1 = -1.5 mA	EVDD0 - 0.5		V
	VOH2	P20 to P27	2.4 V ≤ VDD ≤ 5.5 V, IOH2 = -100 μA	VDD - 0.5		V
Output voltage, low	VOL1	P00 to P06, P10 to P17, P30, P31, P40 to P43, P50 to P55, P70 to P77, P120, P130, P140, P141, P146, P147	4.0 V ≤ EVDD0 ≤ 5.5 V, IOL1 = 8.5 mA		0.7	V
			2.7 V ≤ EVDD0 ≤ 5.5 V, IOL1 = 3.0 mA		0.6	V
			2.7 V ≤ EVDD0 ≤ 5.5 V, IOL1 = 1.5 mA		0.4	V
			2.4 V ≤ EVDD0 ≤ 5.5 V, IOL1 = 0.6 mA		0.4	V
	VOL2	P20 to P27	2.4 V ≤ VDD ≤ 5.5 V, IOL2 = 400 μA		0.4	V
	VOL3	P60 to P63	4.0 V ≤ EVDD0 ≤ 5.5 V, IOL3 = 15.0 mA		2.0	V
			4.0 V ≤ EVDD0 ≤ 5.5 V, IOL3 = 5.0 mA		0.4	V
			2.7 V ≤ EVDD0 ≤ 5.5 V, IOL3 = 3.0 mA		0.4	V
			2.4 V ≤ EVDD0 ≤ 5.5 V, IOL3 = 2.0 mA		0.4	V

**Caution** P00, P02 to P04, P10, P11, P13 to P15, P17, P30, P43, P50 to P55, P71, P74 do not output high level in N-ch open-drain mode.

**Remark** Unless specified otherwise, the characteristics of alternate-function pins are the same as those of the port pins.

(TA = -40 to +105°C, 2.4 V ≤ EVDD0 ≤ VDD ≤ 5.5 V, VSS = EVSS0 = 0 V)

(5/5)

Items	Symbol	Conditions	MIN.	TYP.	MAX.	Unit		
Input leakage current, high	ILIH1	P00 to P06, P10 to P17, P30, P31, P40 to P43, P50 to P55, P70 to P77, P120, P140, P141, P146, P147	Vi = EVDD0			1	μA	
	ILIH2	P20 to P27, P137, $\overline{\text{RESET}}$	Vi = VDD			1	μA	
	ILIH3	P121 to P124 (X1, X2, EXCLK, XT1, XT2, EXCLKS)	Vi = VDD	In input port or external clock input		1	μA	
				In resonator connection		10	μA	
Input leakage current, low	ILIL1	P00 to P06, P10 to P17, P30, P31, P40 to P43, P50 to P55, P70 to P77, P120, P140, P141, P146, P147	Vi = EVSS0			-1	μA	
	ILIL2	P20 to P27, P137, $\overline{\text{RESET}}$	Vi = VSS			-1	μA	
	ILIL3	P121 to P124 (X1, X2, EXCLK, XT1, XT2, EXCLKS)	Vi = VSS	In input port or external clock input		-1	μA	
				In resonator connection		-10	μA	
On-chip pull-up resistance	Ru	P00 to P06, P10 to P17, P30, P31, P40 to P43, P50 to P55, P70 to P77, P120, P140, P141, P146, P147	Vi = EVSS0, In input port		10	20	100	kΩ

**Remark** Unless specified otherwise, the characteristics of alternate-function pins are the same as those of the port pins.



### 3.3.2 Supply current characteristics

(TA = -40 to +105°C, 2.4 V ≤ EVDD0 ≤ VDD ≤ 5.5 V, VSS = EVSS0 = 0 V)

(1/2)

Parameter	Symbol	Conditions				MIN.	TYP.	MAX.	Unit		
Supply current Note 1	IDD1	Operating mode	HS (high-speed main) mode Note 5	fHOCO = 64 MHz, fIH = 32 MHz Note 3	Basic operation	VDD = 5.0 V		2.4		mA	
						VDD = 3.0 V		2.4			
				fHOCO = 32 MHz, fIH = 32 MHz Note 3	Basic operation	VDD = 5.0 V		2.1			
				VDD = 3.0 V			2.1				
			HS (high-speed main) mode Note 5	fHOCO = 64 MHz, fIH = 32 MHz Note 3	Normal operation	VDD = 5.0 V		5.2	9.3		mA
						VDD = 3.0 V		5.2	9.3		
		fHOCO = 32 MHz, fIH = 32 MHz Note 3		Normal operation	VDD = 5.0 V		4.8	8.7			
					VDD = 3.0 V		4.8	8.7			
		fHOCO = 48 MHz, fIH = 24 MHz Note 3		Normal operation	VDD = 5.0 V		4.1	7.3			
					VDD = 3.0 V		4.1	7.3			
		HS (high-speed main) mode Note 5	fHOCO = 24 MHz, fIH = 24 MHz Note 3	Normal operation	VDD = 5.0 V		3.8	6.7	mA		
					VDD = 3.0 V		3.8	6.7			
			fHOCO = 16 MHz, fIH = 16 MHz Note 3	Normal operation	VDD = 5.0 V		2.8	4.9			
					VDD = 3.0 V		2.8	4.9			
		Subsystem clock operation	fSUB = 32.768 kHz Note 4 TA = -40°C	Normal operation	Square wave input		4.7	6.1	μA		
					Resonator connection		4.7	6.1			
			fSUB = 32.768 kHz Note 4 TA = +25°C	Normal operation	Square wave input		4.7	6.1			
					Resonator connection		4.7	6.1			
			fSUB = 32.768 kHz Note 4 TA = +50°C	Normal operation	Square wave input		4.8	6.7			
					Resonator connection		4.8	6.7			
			fSUB = 32.768 kHz Note 4 TA = +70°C	Normal operation	Square wave input		4.8	7.5			
	Resonator connection				4.8	7.5					
fSUB = 32.768 kHz Note 4 TA = +85°C	Normal operation	Square wave input		5.4	8.9						
		Resonator connection		5.4	8.9						
fSUB = 32.768 kHz Note 4 TA = +105°C	Normal operation	Square wave input		7.2	21.0						
		Resonator connection		7.3	21.1						

(Notes and Remarks are listed on the next page.)

- Note 1.** Total current flowing into V<sub>DD</sub> and EV<sub>DD0</sub>, including the input leakage current flowing when the level of the input pin is fixed to V<sub>DD</sub>, EV<sub>DD0</sub> or V<sub>SS</sub>, EV<sub>SS0</sub>. The values below the MAX. column include the peripheral operation current. However, not including the current flowing into the A/D converter, LVD circuit, I/O port, and on-chip pull-up/pull-down resistors and the current flowing during data flash rewrite.
- Note 2.** When high-speed on-chip oscillator and subsystem clock are stopped.
- Note 3.** When high-speed system clock and subsystem clock are stopped.
- Note 4.** When high-speed on-chip oscillator and high-speed system clock are stopped. When AMPHS1 = 1 (Ultra-low power consumption oscillation). However, not including the current flowing into the RTC, 12-bit interval timer, and watchdog timer.
- Note 5.** Relationship between operation voltage width, operation frequency of CPU and operation mode is as below.  
HS (high-speed main) mode: 2.7 V ≤ V<sub>DD</sub> ≤ 5.5 V@1 MHz to 32 MHz  
2.4 V ≤ V<sub>DD</sub> ≤ 5.5 V@1 MHz to 16 MHz

**Remark 1.** f<sub>MX</sub>: High-speed system clock frequency (X1 clock oscillation frequency or external main system clock frequency)

**Remark 2.** f<sub>HOCO</sub>: High-speed on-chip oscillator clock frequency (64 MHz max.)

**Remark 3.** f<sub>IH</sub>: High-speed on-chip oscillator clock frequency (32 MHz max.)

**Remark 4.** f<sub>SUB</sub>: Subsystem clock frequency (XT1 clock oscillation frequency)

**Remark 5.** Except subsystem clock operation, temperature condition of the TYP. value is TA = 25°C

(TA = -40 to +105°C, 2.4 V ≤ EVDD0 ≤ VDD ≤ 5.5 V, VSS = EVSS0 = 0 V)

(2/2)

Parameter	Symbol	Conditions		MIN.	TYP.	MAX.	Unit		
Supply current Note 1	IDD2 Note 2	HALT mode	HS (high-speed main) mode Note 7	fHOCO = 64 MHz, fIH = 32 MHz Note 4	VDD = 5.0 V		0.80	4.36	mA
					VDD = 3.0 V		0.80	4.36	
				fHOCO = 32 MHz, fIH = 32 MHz Note 4	VDD = 5.0 V		0.54	3.67	
					VDD = 3.0 V		0.54	3.67	
				fHOCO = 48 MHz, fIH = 24 MHz Note 4	VDD = 5.0 V		0.62	3.42	
					VDD = 3.0 V		0.62	3.42	
			fHOCO = 24 MHz, fIH = 24 MHz Note 4	VDD = 5.0 V		0.44	2.85		
				VDD = 3.0 V		0.44	2.85		
			fHOCO = 16 MHz, fIH = 16 MHz Note 4	VDD = 5.0 V		0.40	2.08		
				VDD = 3.0 V		0.40	2.08		
			HS (high-speed main) mode Note 7	fMX = 20 MHz Note 3, VDD = 5.0 V	Square wave input		0.28	2.45	mA
					Resonator connection		0.49	2.57	
	fMX = 20 MHz Note 3, VDD = 3.0 V	Square wave input			0.28	2.45			
		Resonator connection			0.49	2.57			
	fMX = 10 MHz Note 3, VDD = 5.0 V	Square wave input			0.19	1.28			
		Resonator connection			0.30	1.36			
	fMX = 10 MHz Note 3, VDD = 3.0 V	Square wave input			0.19	1.28			
		Resonator connection			0.30	1.36			
	Subsystem clock operation	fSUB = 32.768 kHz Note 5, TA = -40°C		Square wave input		0.25	0.57	μA	
				Resonator connection		0.44	0.76		
		fSUB = 32.768 kHz Note 5, TA = +25°C		Square wave input		0.30	0.57		
				Resonator connection		0.49	0.76		
		fSUB = 32.768 kHz Note 5, TA = +50°C	Square wave input		0.36	1.17			
		Resonator connection		0.59	1.36				
fSUB = 32.768 kHz Note 5, TA = +70°C	Square wave input		0.49	1.97					
	Resonator connection		0.72	2.16					
fSUB = 32.768 kHz Note 5, TA = +85°C	Square wave input		0.97	3.37					
	Resonator connection		1.16	3.56					
fSUB = 32.768 kHz Note 5, TA = +105°C	Square wave input		3.20	17.10					
	Resonator connection		3.40	17.50					
IDD3 Note 6	STOP mode Note 8	TA = -40°C			0.18	0.51	μA		
		TA = +25°C			0.24	0.51			
		TA = +50°C			0.29	1.10			
		TA = +70°C			0.41	1.90			
		TA = +85°C			0.90	3.30			
		TA = +105°C			3.10	17.00			

(Notes and Remarks are listed on the next page.)

- Note 1.** Total current flowing into V<sub>DD</sub> and EV<sub>DD0</sub>, including the input leakage current flowing when the level of the input pin is fixed to V<sub>DD</sub>, EV<sub>DD0</sub> or V<sub>SS</sub>, EV<sub>SS0</sub>. The values below the MAX. column include the peripheral operation current. However, not including the current flowing into the A/D converter, LVD circuit, I/O port, and on-chip pull-up/pull-down resistors and the current flowing during data flash rewrite.
- Note 2.** During HALT instruction execution by flash memory.
- Note 3.** When high-speed on-chip oscillator and subsystem clock are stopped.
- Note 4.** When high-speed system clock and subsystem clock are stopped.
- Note 5.** When high-speed on-chip oscillator and high-speed system clock are stopped. When RTCLPC = 1 and setting ultra-low current consumption (AMPHS1 = 1). The current flowing into the RTC is included. However, not including the current flowing into the 12-bit interval timer and watchdog timer.
- Note 6.** Not including the current flowing into the RTC, 12-bit interval timer, and watchdog timer.
- Note 7.** Relationship between operation voltage width, operation frequency of CPU and operation mode is as below.  
 HS (high-speed main) mode:  $2.7\text{ V} \leq V_{DD} \leq 5.5\text{ V}@1\text{ MHz to }32\text{ MHz}$   
 $2.4\text{ V} \leq V_{DD} \leq 5.5\text{ V}@1\text{ MHz to }16\text{ MHz}$
- Note 8.** Regarding the value for current to operate the subsystem clock in STOP mode, refer to that in HALT mode.
- Remark 1.** f<sub>MX</sub>: High-speed system clock frequency (X1 clock oscillation frequency or external main system clock frequency)
- Remark 2.** f<sub>HOCO</sub>: High-speed on-chip oscillator clock frequency (64 MHz max.)
- Remark 3.** f<sub>IH</sub>: High-speed on-chip oscillator clock frequency (32 MHz max.)
- Remark 4.** f<sub>SUB</sub>: Subsystem clock frequency (XT1 clock oscillation frequency)
- Remark 5.** Except subsystem clock operation and STOP mode, temperature condition of the TYP. value is TA = 25°C

(TA = -40 to +105°C, 2.4 V ≤ EVDD0 ≤ VDD ≤ 5.5 V, VSS = EVSS0 = 0 V)

Parameter	Symbol	Conditions		MIN.	TYP.	MAX.	Unit
Low-speed on-chip oscillator operating current	IFIL Note 1				0.2		μA
RTC operating current	IRTC Notes 1, 2, 3				0.02		μA
12-bit interval timer operating current	IIT Notes 1, 2, 4				0.02		μA
Watchdog timer operating current	IWDT Notes 1, 2, 5	fil = 15 kHz			0.22		μA
A/D converter operating current	IADC Notes 1, 6	When conversion at maximum speed	Normal mode, AVREFP = VDD = 5.0 V		1.3	1.7	mA
			Low voltage mode, AVREFP = VDD = 3.0 V		0.5	0.7	mA
A/D converter reference voltage current	IADREF Note 1				75		μA
Temperature sensor operating current	ITMPS Note 1				75		μA
D/A converter operating current	IDAC Notes 1, 11	Per D/A converter channel				1.5	mA
PGA operating current		Operation			480	700	μA
Comparator operating current	ICMP Notes 1, 12	Operation (per comparator channel, constant current for comparator included)	When the internal reference voltage is not in use		50	100	μA
			When the internal reference voltage is in use		60	110	μA
LVD operating current	ILVD Notes 1, 7				0.08		μA
Self-programming operating current	IFSP Notes 1, 9				2.50	12.2	mA
BGO operating current	IBGO Notes 1, 8				2.50	12.2	mA
SNOOZE operating current	ISNOZ Note 1	ADC operation	The mode is performed Note 10		0.50	1.10	mA
			The A/D conversion operations are performed, Low voltage mode, AVREFP = VDD = 3.0 V		1.20	2.04	
		CSI/UART operation		0.70	1.54		
		DTC operation		3.10			

**Note 1.** Current flowing to VDD.

**Note 2.** When high speed on-chip oscillator and high-speed system clock are stopped.

**Note 3.** Current flowing only to the real-time clock (RTC) (excluding the operating current of the low-speed on-chip oscillator and the XT1 oscillator). The supply current of the RL78 microcontrollers is the sum of the values of either IDD1 or IDD2, and IRTC, when the real-time clock operates in operation mode or HALT mode. When the low-speed on-chip oscillator is selected, IFIL should be added. IDD2 subsystem clock operation includes the operational current of the real-time clock.

**Note 4.** Current flowing only to the 12-bit interval timer (excluding the operating current of the low-speed on-chip oscillator and the XT1 oscillator). The supply current of the RL78 microcontrollers is the sum of the values of either IDD1 or IDD2, and IIT, when the 12-bit interval timer operates in operation mode or HALT mode. When the low-speed on-chip oscillator is selected, IFIL should be added.

**Note 5.** Current flowing only to the watchdog timer (including the operating current of the low-speed on-chip oscillator). The supply current of the RL78 microcontrollers is the sum of IDD1, IDD2 or IDD3 and IWDT when the watchdog timer is in operation.

**Note 6.** Current flowing only to the A/D converter. The supply current of the RL78 microcontrollers is the sum of IDD1 or IDD2 and IADC when the A/D converter operates in an operation mode or the HALT mode.

**Note 7.** Current flowing only to the LVD circuit. The supply current of the RL78 microcontrollers is the sum of IDD1, IDD2 or IDD3 and ILVD when the LVD circuit is in operation.

**Note 8.** Current flowing during programming of the data flash.

**Note 9.** Current flowing during self-programming.

**Note 10.** For shift time to the SNOOZE mode, see **26.3.3 SNOOZE mode** in the RL78/G1F User's Manual.

- Note 11.** Current flowing only to the D/A converter. The supply current of the RL78 microcontrollers is the sum of IDD1 or IDD2 and IDAC when the D/A converter operates in an operation mode or the HALT mode.
- Note 12.** Current flowing only to the comparator circuit. The supply current of the RL78 microcontrollers is the sum of IDD1, IDD2, or IDD3 and ICMP when the comparator circuit is in operation.
- Remark 1.** f<sub>IL</sub>: Low-speed on-chip oscillator clock frequency
- Remark 2.** f<sub>SUB</sub>: Subsystem clock frequency (XT1 clock oscillation frequency)
- Remark 3.** f<sub>CLK</sub>: CPU/peripheral hardware clock frequency
- Remark 4.** Temperature condition of the TYP. value is TA = 25°C

### 3.4 AC Characteristics

(TA = -40 to +105°C, 2.4 V ≤ EVDD0 ≤ VDD ≤ 5.5 V, VSS = EVSS0 = 0 V)

Items	Symbol	Conditions		MIN.	TYP.	MAX.	Unit	
Instruction cycle (minimum instruction execution time)	Tcy	Main system clock (fMAIN) operation	HS (high-speed main) mode	2.7 V ≤ VDD ≤ 5.5 V	0.03125		1	μs
				2.4 V ≤ VDD < 2.7 V	0.0625		1	μs
		Subsystem clock (fSUB) operation		2.4 V ≤ VDD ≤ 5.5 V	28.5	30.5	31.3	μs
		In the self-programming mode	HS (high-speed main) mode	2.7 V ≤ VDD ≤ 5.5 V	0.03125		1	μs
	2.4 V ≤ VDD < 2.7 V		0.0625		1	μs		
External system clock frequency	fEX	2.7 V ≤ VDD ≤ 5.5 V		1.0		20.0	MHz	
		2.4 V ≤ VDD ≤ 2.7 V		1.0		16.0	MHz	
	fEXS			32		35	kHz	
External system clock input high-level width, low-level width	tEXH,	2.7 V ≤ VDD ≤ 5.5 V		24			ns	
	tEXL	2.4 V ≤ VDD ≤ 2.7 V		30			ns	
	tEXHS, tEXLS			13.7			μs	
Ti00 to Ti03 input high-level width, low-level width	tTih, tTil			1/fMCK + 10 Note			ns	
Timer RJ input cycle	fc	TRJIO		2.7 V ≤ EVDD0 ≤ 5.5 V	100		ns	
				2.4 V ≤ EVDD0 < 2.7 V	300		ns	
Timer RJ input high-level width, low-level width	tTjH, tTjL	TRJIO		2.7 V ≤ EVDD0 ≤ 5.5 V	40		ns	
				2.4 V ≤ EVDD0 < 2.7 V	120		ns	

**Note** The following conditions are required for low voltage interface when EVDD0 < VDD  
2.4 V ≤ EVDD0 < 2.7 V: MIN. 125 ns

**Remark** fMCK: Timer array unit operation clock frequency  
(Operation clock to be set by the CKSmn bit of timer mode register mn (TMRmn). m: Unit number (m = 0, 1), n: Channel number (n = 0 to 3))

(TA = -40 to +105°C, 2.4 V ≤ EVDD0 ≤ VDD ≤ 5.5 V, VSS = EVSS0 = 0 V)

(2/2)

Items	Symbol	Conditions		MIN.	TYP.	MAX.	Unit
Timer RD input high-level width, low-level width	tTDIH, tTDIL	TRDIOA0, TRDIOA1, TRDIOB0, TRDIOB1, TRDIOC0, TRDIOC1, TRDIOD0, TRDIOD1		3/fCLK			ns
Timer RD forced cutoff signal input low-level width	tTDSIL	P130/INTP0	2MHz < fCLK ≤ 32 MHz	1			μs
			fCLK ≤ 2 MHz	1/fCLK + 1			
Timer RG input high-level width, low-level width	tTGIH, tTGIL	TRGIOA, TRGIOB		2.5/fCLK			ns
TO00 to TO03, TRJIO0, TRJO0, TRDIOA0, TRDIOA1, TRDIOB0, TRDIOB1, TRDIOC0, TRDIOC1, TRDIOD0, TRDIOD1, TRGIOA, TRGIOB output frequency	fTO	HS (high-speed main) mode	4.0 V ≤ EVDD0 ≤ 5.5 V			16	MHz
			2.7 V ≤ EVDD0 < 4.0 V			8	MHz
			2.4 V ≤ EVDD0 < 2.7 V			4	MHz
PCLBUZ0, PCLBUZ1 output frequency	fPCL	HS (high-speed main) mode	4.0 V ≤ EVDD0 ≤ 5.5 V			16	MHz
			2.7 V ≤ EVDD0 < 4.0 V			8	MHz
			2.4 V ≤ EVDD0 < 2.7 V			4	MHz
Interrupt input high-level width, low-level width	tINTH, tINTL	INTP0	2.4 V ≤ VDD ≤ 5.5 V	1			μs
		INTP1 to INTP11	2.4 V ≤ EVDD0 ≤ 5.5 V	1			μs
Key interrupt input low-level width	tKR	KR0 to KR7	2.4 V ≤ EVDD0 ≤ 5.5 V	250			ns
RESET low-level width	tRSL			10			μs



Minimum Instruction Execution Time during Main System Clock Operation

T<sub>cy</sub> vs V<sub>DD</sub> (HS (high-speed main) mode)

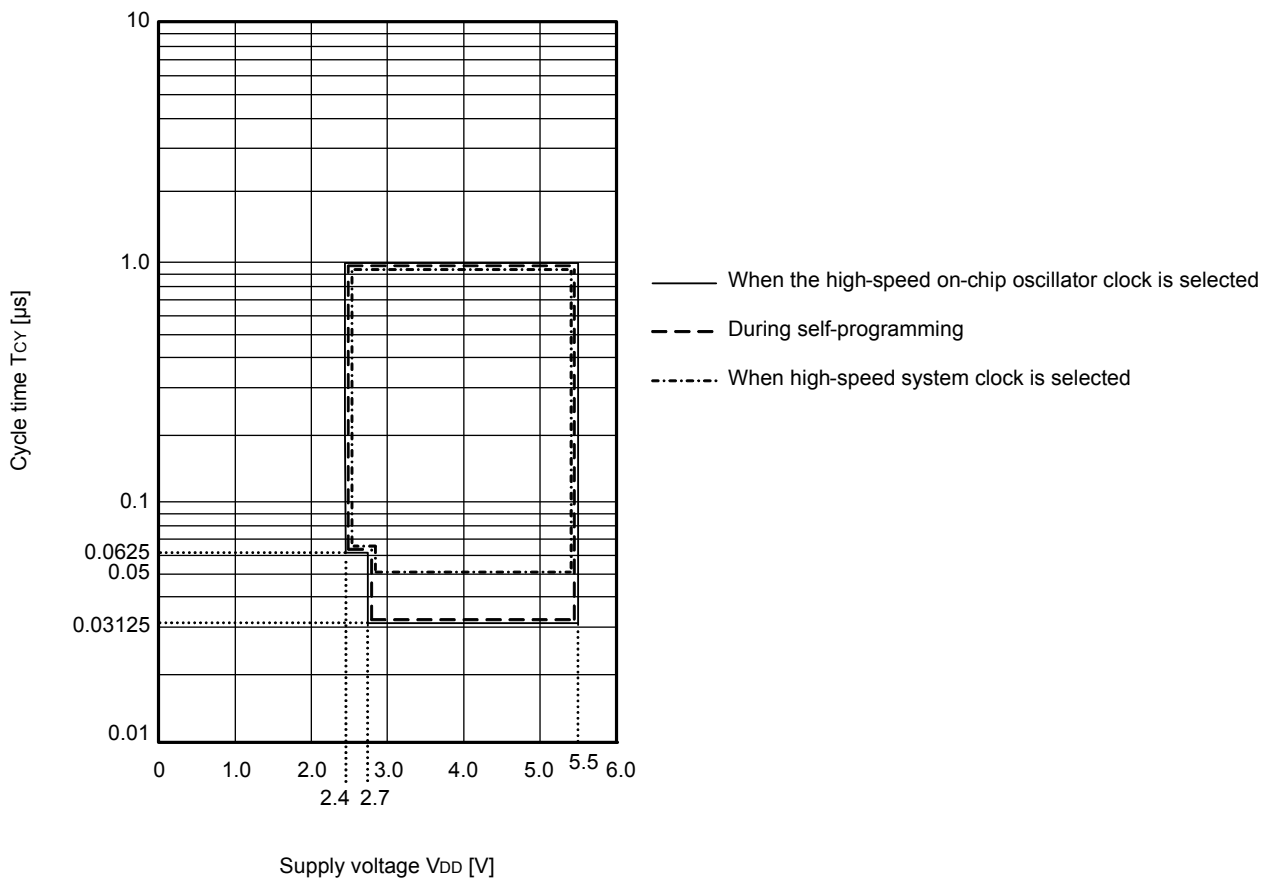

AC Timing Test Points

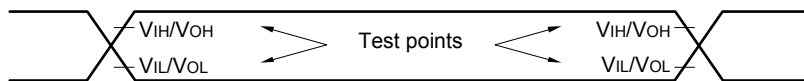

External System Clock Timing

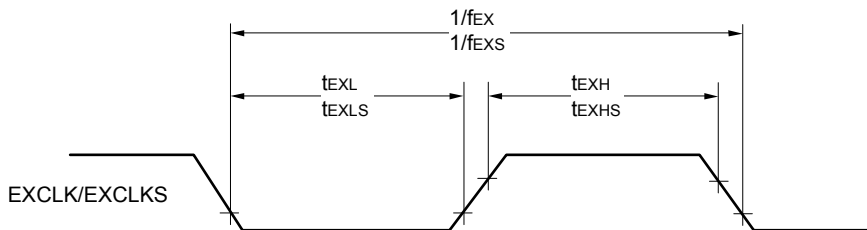

TI/TO Timing

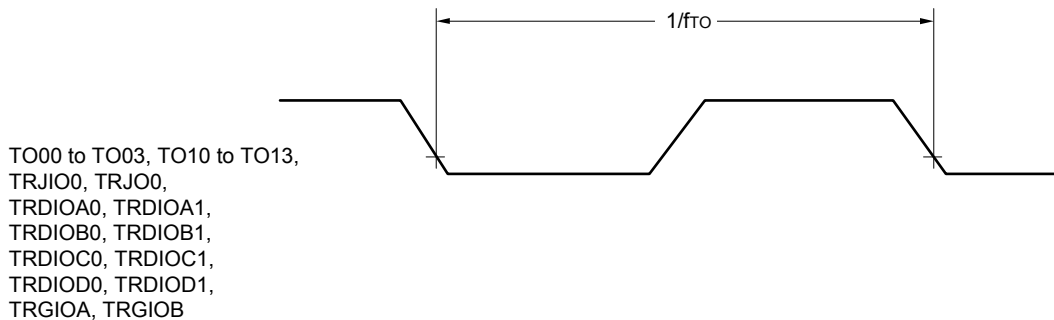
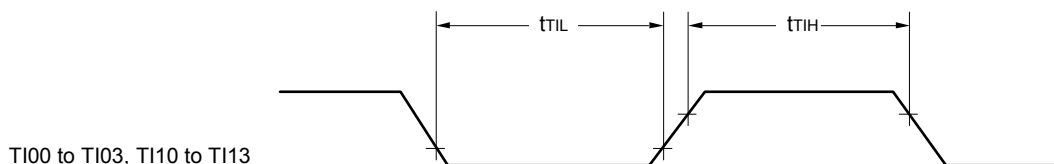

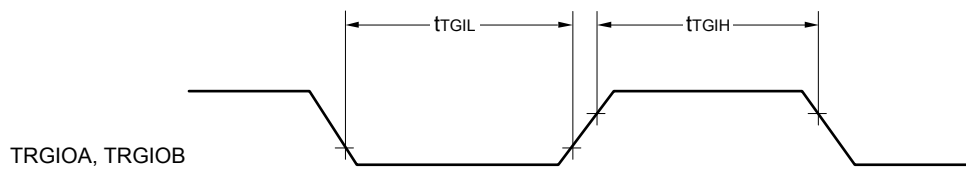
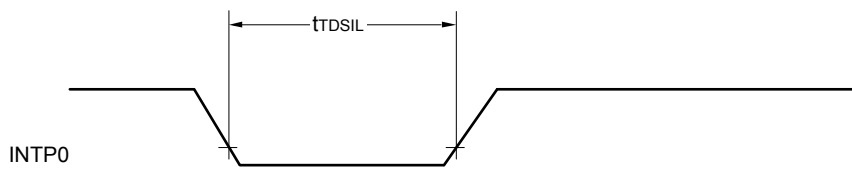
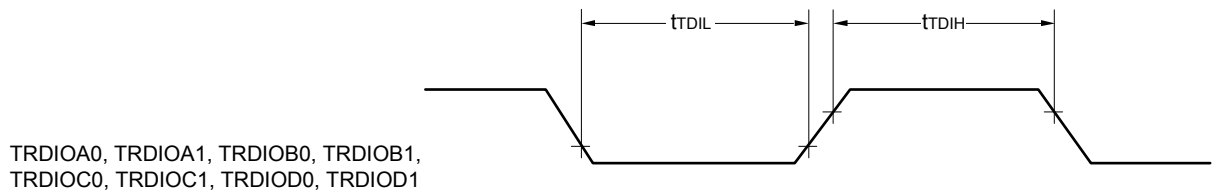
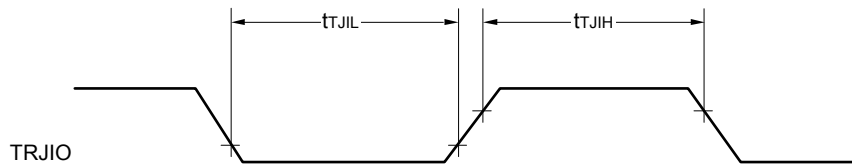

Interrupt Request Input Timing

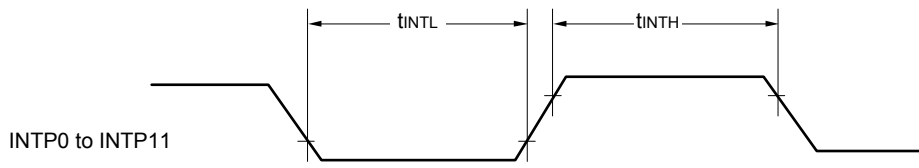

Key Interrupt Input Timing

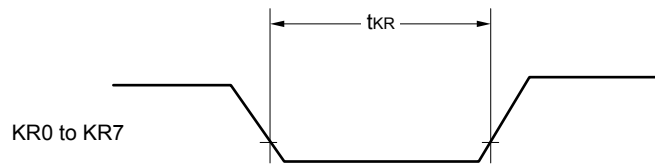

$\overline{\text{RESET}}$  Input Timing

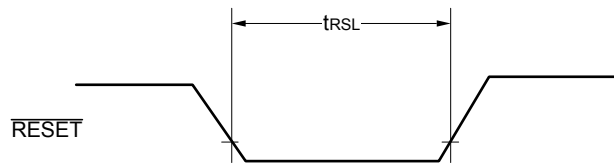

### 3.5 Peripheral Functions Characteristics

AC Timing Test Points

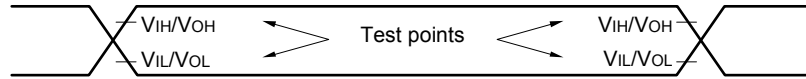

#### 3.5.1 Serial array unit

**(1) During communication at same potential (UART mode)**

(TA = -40 to +105°C, 2.4 V ≤ EVDD0 ≤ 5.5 V, VSS = EVSS0 = 0 V)

Parameter	Symbol	Conditions	HS (high-speed main) Mode		Unit
			MIN.	MAX.	
Transfer rate Note 1		2.4 V ≤ EVDD0 ≤ 5.5 V		fMCK/12 Note 2	bps
		Theoretical value of the maximum transfer rate fMCK = fCLK Note 3		2.6	Mbps

**Note 1.** Transfer rate in the SNOOZE mode is 4800 bps only.

However, the SNOOZE mode cannot be used when FRQSEL4 = 1.

**Note 2.** The following conditions are required for low voltage interface when EVDD0 < VDD.

2.4 V ≤ EVDD0 < 2.7 V: MAX.1.3 Mbps

**Note 3.** The maximum operating frequencies of the CPU/peripheral hardware clock (fCLK) are:

HS (high-speed main) mode: 32 MHz (2.7 V ≤ VDD ≤ 5.5 V)

16 MHz (2.4 V ≤ VDD ≤ 5.5 V)

**Caution** Select the normal input buffer for the RxDq pin and the normal output mode for the TxDq pin by using port input mode register g (PIMg) and port output mode register g (POMg).

**UART mode connection diagram (during communication at same potential)**

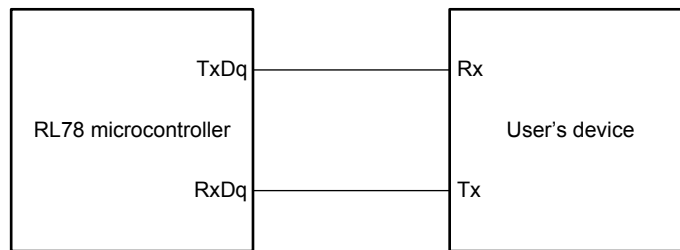

**UART mode bit width (during communication at same potential) (reference)**

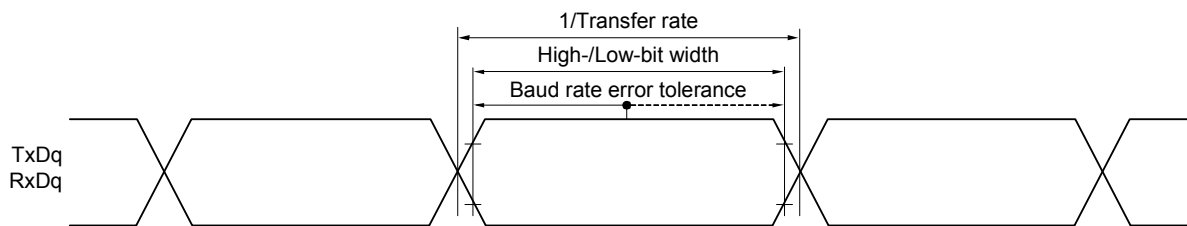

**Remark 1.** q: UART number (q = 0 to 2), g: PIM and POM number (g = 0, 1, 3, 5, 7)

**Remark 2.** f<sub>MCK</sub>: Serial array unit operation clock frequency

(Operation clock to be set by the CKSmn bit of serial mode register mn (SMRmn). m: Unit number, n: Channel number (mn = 00 to 03, 10, 11))

**(2) During communication at same potential (CSI mode) (master mode, SCKp... internal clock output)**  
**(TA = -40 to +105°C, 2.4 V ≤ EVDD0 ≤ VDD ≤ 5.5 V, VSS = EVSS0 = 0 V)**

Parameter	Symbol	Conditions	HS (high-speed main) mode		Unit
			MIN.	MAX.	
SCKp cycle time	tkCY1	tkCY1 ≥ 2/fCLK 2.7 V ≤ EVDD0 ≤ 5.5 V	250		ns
			500		ns
SCKp high-/low-level width	tkH1, tkL1	4.0 V ≤ EVDD0 ≤ 5.5 V	tkCY1/2 - 24		ns
		2.7 V ≤ EVDD0 ≤ 5.5 V	tkCY1/2 - 36		ns
		2.4 V ≤ EVDD0 ≤ 5.5 V	tkCY1/2 - 76		
Slp setup time (to SCKp↑) Note 1	tSIK1	4.0 V ≤ EVDD0 ≤ 5.5 V	66		ns
		2.7 V ≤ EVDD0 ≤ 5.5 V	66		ns
		2.4 V ≤ EVDD0 ≤ 5.5 V	113		
Slp hold time (from SCKp↑) Note 2	tKSI1	2.7 V ≤ EVDD0 ≤ 5.5 V	38		ns
Delay time from SCKp↓ to SOp output Note 3	tKSO1	C = 20 pF Note 4		50	ns

**Note 1.** When DAPmn = 0 and CKPmn = 0, or DAPmn = 1 and CKPmn = 1. The Slp setup time becomes “to SCKp↓” when DAPmn = 0 and CKPmn = 1, or DAPmn = 1 and CKPmn = 0.

**Note 2.** When DAPmn = 0 and CKPmn = 0, or DAPmn = 1 and CKPmn = 1. The Slp hold time becomes “from SCKp↓” when DAPmn = 0 and CKPmn = 1, or DAPmn = 1 and CKPmn = 0.

**Note 3.** When DAPmn = 0 and CKPmn = 0, or DAPmn = 1 and CKPmn = 1. The delay time to SOp output becomes “from SCKp↑” when DAPmn = 0 and CKPmn = 1, or DAPmn = 1 and CKPmn = 0.

**Note 4.** C is the load capacitance of the SCKp and SOp output lines.

**Caution** Select the normal input buffer for the Slp pin and the normal output mode for the SOp pin and SCKp pin by using port input mode register g (PIMg) and port output mode register g (POMg).

**Remark 1.** p: CSI number (p = 00, 01, 10, 11, 20, 21), m: Unit number (m = 0, 1), n: Channel number (n = 0 to 3), g: PIM number (g = 0, 1, 3, 5, 7)

**Remark 2.** fMCK: Serial array unit operation clock frequency  
 (Operation clock to be set by the CKSmn bit of serial mode register mn (SMRmn). m: Unit number, n: Channel number (mn = 00 to 03, 10, 11))

**(3) During communication at same potential (CSI mode) (slave mode, SCKp... external clock input)**  
**(TA = -40 to +105°C, 2.4 V ≤ EVDD0 ≤ VDD ≤ 5.5 V, VSS = EVSS0 = 0 V)**

Parameter	Symbol	Conditions		HS (high-speed main) mode		Unit
				MIN.	MAX.	
SCKp cycle time Note 5	tkCY2	4.0 V ≤ EVDD0 ≤ 5.5 V	20 MHz < fMCK	16/fMCK		ns
			fMCK ≤ 20 MHz	12/fMCK		ns
		2.7 V ≤ EVDD0 ≤ 5.5 V	16 MHz < fMCK	16/fMCK		ns
			fMCK ≤ 16 MHz	12/fMCK		ns
		2.4 V ≤ EVDD0 ≤ 5.5 V		12/fMCK and 1000		ns
SCKp high-/low-level width	tkH2, tkL2	4.0 V ≤ EVDD0 ≤ 5.5 V		tkCY2/2 - 14		ns
		2.7 V ≤ EVDD0 ≤ 5.5 V		tkCY2/2 - 16		ns
		2.4 V ≤ EVDD0 ≤ 5.5 V		1/fMCK + 36		ns
Slp setup time (to SCKp↑) Note 1	tsIK2	2.7 V ≤ EVDD0 ≤ 5.5 V		1/fMCK + 40		ns
		2.4 V ≤ EVDD0 ≤ 5.5 V		1/fMCK + 60		ns
Slp hold time (from SCKp↑) Note 2	tkSI2			1/fMCK + 62		ns
Delay time from SCKp↓ to SOp output Note 3	tkSO2	C = 30 pF Note 4	2.7 V ≤ EVDD0 ≤ 5.5 V		2/fMCK + 66	ns
			2.4 V ≤ EVDD0 ≤ 5.5 V		2/fMCK + 113	ns

**Note 1.** When DAPmn = 0 and CKPmn = 0, or DAPmn = 1 and CKPmn = 1. The Slp setup time becomes “to SCKp↓” when DAPmn = 0 and CKPmn = 1, or DAPmn = 1 and CKPmn = 0.

**Note 2.** When DAPmn = 0 and CKPmn = 0, or DAPmn = 1 and CKPmn = 1. The Slp hold time becomes “from SCKp↓” when DAPmn = 0 and CKPmn = 1, or DAPmn = 1 and CKPmn = 0.

**Note 3.** When DAPmn = 0 and CKPmn = 0, or DAPmn = 1 and CKPmn = 1. The delay time to SOp output becomes “from SCKp↑” when DAPmn = 0 and CKPmn = 1, or DAPmn = 1 and CKPmn = 0.

**Note 4.** C is the load capacitance of the SOp output lines.

**Note 5.** The maximum transfer rate when using the SNOOZE mode is 1 Mbps.

**Caution** Select the normal input buffer for the Slp pin and SCKp pin and the normal output mode for the SOp pin by using port input mode register g (PIMg) and port output mode register g (POMg).

**Remark 1.** p: CSI number (p = 00, 01, 10, 11, 20, 21), m: Unit number (m = 0, 1),  
n: Channel number (n = 0 to 3), g: PIM number (g = 0, 1, 3, 5, 7)

**Remark 2.** fMCK: Serial array unit operation clock frequency  
(Operation clock to be set by the CKSmn bit of serial mode register mn (SMRmn). m: Unit number,  
n: Channel number (mn = 00 to 03, 10, 11))



**(3) During communication at same potential (CSI mode) (slave mode, SCKp... external clock input)**  
**(TA = -40 to +105°C, 2.4 V ≤ EVDD0 ≤ VDD ≤ 5.5 V, VSS = EVSS0 = 0 V)(2/2)**

Parameter	Symbol	Conditions	HS (high-speed main) mode		Unit	
			MIN.	MAX.		
SSIO0 setup time	tSSIK	DAPmn = 0	2.7 V ≤ EVDD0 ≤ 5.5 V	240		ns
			2.4 V ≤ EVDD0 ≤ 5.5 V	400		ns
		DAPmn = 1	2.7 V ≤ EVDD0 ≤ 5.5 V	1/fMCK + 240		ns
			2.4 V ≤ EVDD0 ≤ 5.5 V	1/fMCK + 400		ns
SSIO0 hold time	tKSSI	DAPmn = 0	2.7 V ≤ EVDD0 ≤ 5.5 V	1/fMCK + 240		ns
			2.4 V ≤ EVDD0 ≤ 5.5 V	1/fMCK + 400		ns
		DAPmn = 1	2.7 V ≤ EVDD0 ≤ 5.5 V	240		ns
			2.4 V ≤ EVDD0 ≤ 5.5 V	400		ns

**Caution** Select the normal input buffer for the Slp pin and SCKp pin and the normal output mode for the SOp pin by using port input mode register g (PIMg) and port output mode register g (POMg).

**Remark** p: CSI number (p = 00), m: Unit number (m = 0), n: Channel number (n = 0), g: PIM number (g = 3, 5)

**CSI mode connection diagram (during communication at same potential)**

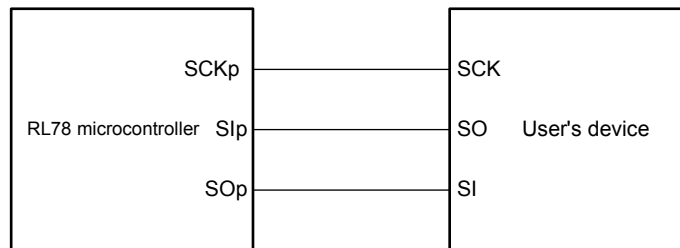

**CSI mode connection diagram (during communication at same potential)**  
**(Slave Transmission of slave select input function (CSI00))**

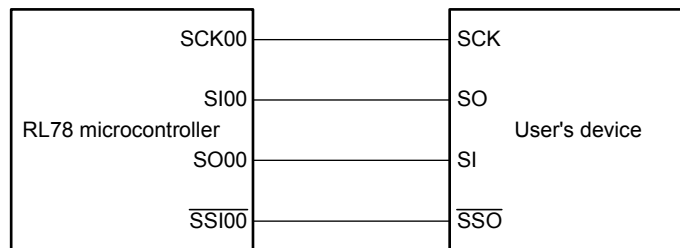

**Remark 1.** p: CSI number (p = 00, 01, 10, 11, 20, 21)

**Remark 2.** m: Unit number, n: Channel number (mn = 00 to 03, 10, 11)

**CSI mode serial transfer timing (during communication at same potential)**  
**(When DAPmn = 0 and CKPmn = 0, or DAPmn = 1 and CKPmn = 1.)**

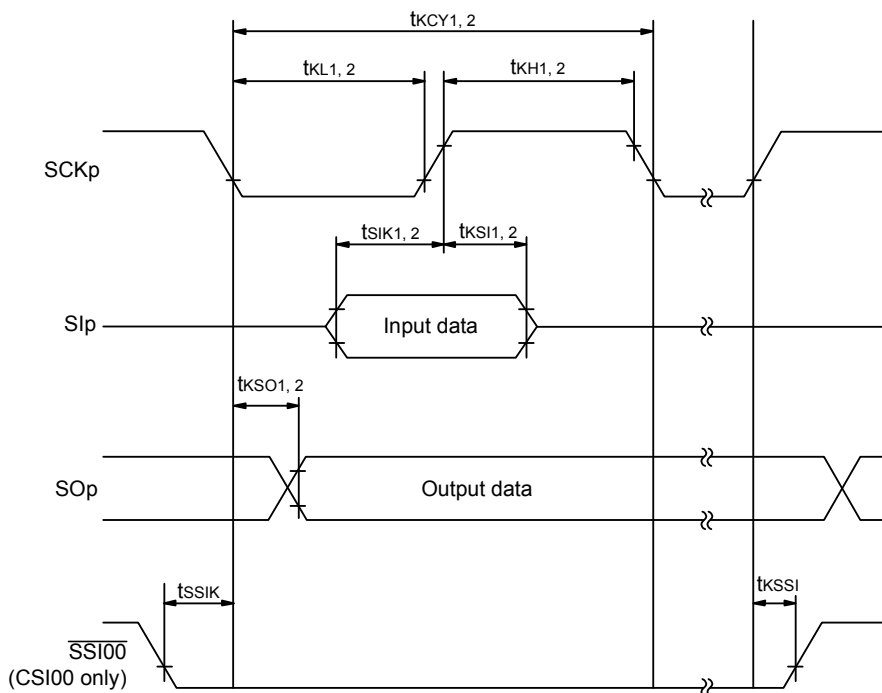

**CSI mode serial transfer timing (during communication at same potential)**  
**(When DAPmn = 0 and CKPmn = 1, or DAPmn = 1 and CKPmn = 0.)**

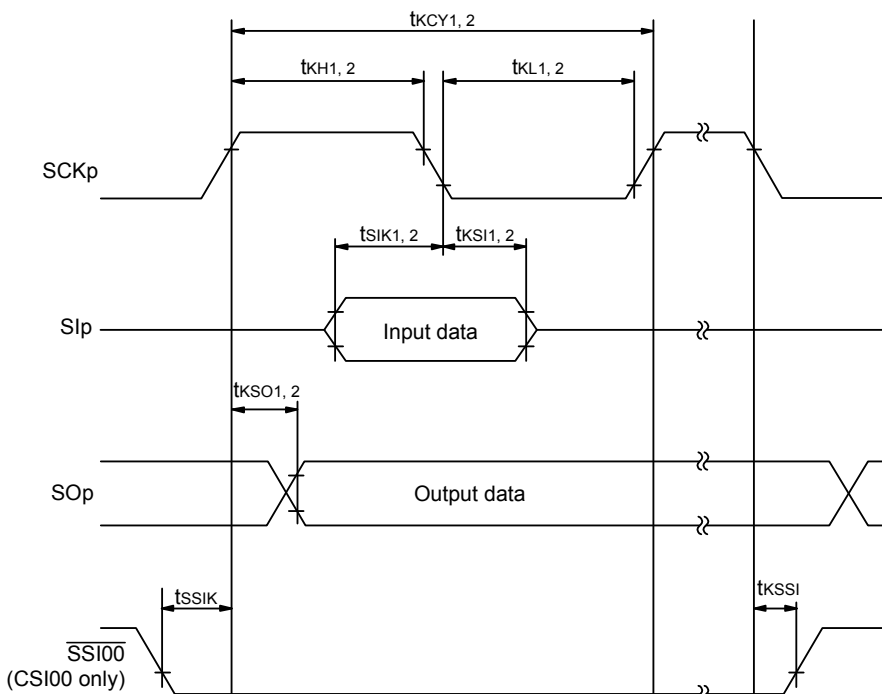

**Remark 1.** p: CSI number (p = 00, 01, 10, 11, 20, 21)

**Remark 2.** m: Unit number, n: Channel number (mn = 00 to 03, 10, 11)

**(4) During communication at same potential (simplified I<sup>2</sup>C mode)****(TA = -40 to +105°C, 2.4 V ≤ EV<sub>DD0</sub> ≤ V<sub>DD</sub> ≤ 5.5 V, V<sub>SS</sub> = EV<sub>SS0</sub> = 0 V)**

Parameter	Symbol	Conditions	HS (high-speed main) mode		Unit
			MIN.	MAX.	
SCLr clock frequency	f <sub>SCL</sub>	2.7 V ≤ EV <sub>DD0</sub> ≤ 5.5 V, C <sub>b</sub> = 50 pF, R <sub>b</sub> = 2.7 kΩ		400 Note 1	kHz
		2.4 V ≤ EV <sub>DD0</sub> ≤ 5.5 V, C <sub>b</sub> = 100 pF, R <sub>b</sub> = 3 kΩ		100 Note 1	kHz
Hold time when SCLr = "L"	t <sub>LOW</sub>	2.7 V ≤ EV <sub>DD0</sub> ≤ 5.5 V, C <sub>b</sub> = 50 pF, R <sub>b</sub> = 2.7 kΩ	1200		ns
		2.4 V ≤ EV <sub>DD0</sub> ≤ 5.5 V, C <sub>b</sub> = 100 pF, R <sub>b</sub> = 3 kΩ	4600		ns
Hold time when SCLr = "H"	t <sub>HIGH</sub>	2.7 V ≤ EV <sub>DD0</sub> ≤ 5.5 V, C <sub>b</sub> = 50 pF, R <sub>b</sub> = 2.7 kΩ	1200		ns
		2.4 V ≤ EV <sub>DD0</sub> ≤ 5.5 V, C <sub>b</sub> = 100 pF, R <sub>b</sub> = 3 kΩ	4600		ns
Data setup time (reception)	t <sub>SU: DAT</sub>	2.7 V ≤ EV <sub>DD0</sub> ≤ 5.5 V, C <sub>b</sub> = 50 pF, R <sub>b</sub> = 2.7 kΩ	1/f <sub>MCK</sub> + 220 Note 2		ns
		2.4 V ≤ EV <sub>DD0</sub> ≤ 5.5 V, C <sub>b</sub> = 100 pF, R <sub>b</sub> = 3 kΩ	1/f <sub>MCK</sub> + 580 Note 2		ns
Data hold time (transmission)	t <sub>HD: DAT</sub>	2.7 V ≤ EV <sub>DD0</sub> ≤ 5.5 V, C <sub>b</sub> = 50 pF, R <sub>b</sub> = 2.7 kΩ	0	770	ns
		2.4 V ≤ EV <sub>DD0</sub> ≤ 5.5 V, C <sub>b</sub> = 100 pF, R <sub>b</sub> = 3 kΩ	0	1420	ns

**Note 1.** The value must also be equal to or less than f<sub>MCK</sub>/4.**Note 2.** Set the f<sub>MCK</sub> value to keep the hold time of SCLr = "L" and SCLr = "H".

**Caution** Select the normal input buffer and the N-ch open drain output (V<sub>bd</sub> tolerance (for the 48-, 32-, 24-pin products)/EV<sub>DD</sub> tolerance (for the 64-, 36-pin products)) mode for the SDAr pin and the normal output mode for the SCLr pin by using port input mode register g (PIMg) and port output mode register h (POMh).

(Remarks are listed on the next page.)

**Simplified I<sup>2</sup>C mode connection diagram (during communication at same potential)**

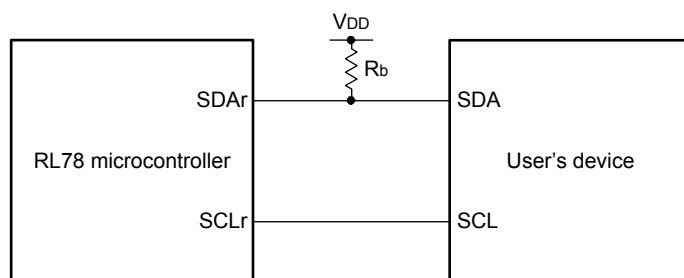

**Simplified I<sup>2</sup>C mode serial transfer timing (during communication at same potential)**

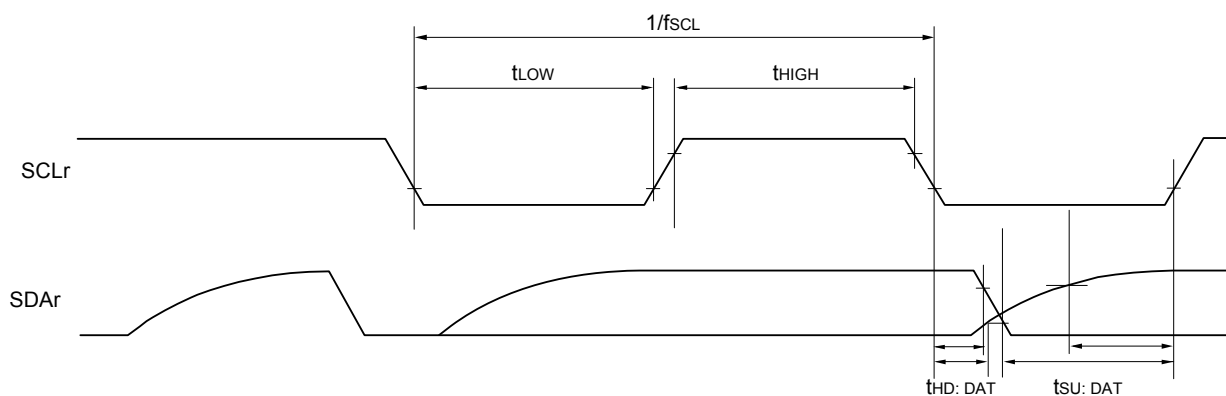

**Remark 1.** R<sub>b</sub>[Ω]: Communication line (SDAr) pull-up resistance, C<sub>b</sub>[F]: Communication line (SDAr, SCLr) load capacitance

**Remark 2.** r: IIC number (r = 00, 01, 10, 11, 20, 21), g: PIM number (g = 0, 1, 3, 5, 7),  
h: POM number (h = 0, 1, 3, 5, 7)

**Remark 3.** f<sub>MCK</sub>: Serial array unit operation clock frequency  
(Operation clock to be set by the CKSMn bit of serial mode register mn (SMRmn). m: Unit number (m = 0, 1),  
n: Channel number (n = 0 to 3), mn = 00 to 03, 10, 11)

**(5) Communication at different potential (1.8 V, 2.5 V, 3 V) (UART mode)****(TA = -40 to +105°C, 2.4 V ≤ EVDD0 ≤ VDD ≤ 5.5 V, VSS = EVSS0 = 0 V)****(1/2)**

Parameter	Symbol	Conditions	HS (high-speed main) mode		Unit	
			MIN.	MAX.		
Transfer rate		reception	4.0 V ≤ EVDD0 ≤ 5.5 V, 2.7 V ≤ Vb ≤ 4.0 V		f <sub>mck</sub> /12 Note 1	bps
			Theoretical value of the maximum transfer rate f <sub>mck</sub> = f <sub>clk</sub> Note 3		2.6	Mbps
			2.7 V ≤ EVDD0 < 4.0 V, 2.3 V ≤ Vb ≤ 2.7 V		f <sub>mck</sub> /12 Note 1	bps
			Theoretical value of the maximum transfer rate f <sub>mck</sub> = f <sub>clk</sub> Note 3		2.6	Mbps
			2.4 V ≤ EVDD0 < 3.3 V, 1.6 V ≤ Vb ≤ 2.0 V		f <sub>mck</sub> /12 Notes 1, 2	bps
			Theoretical value of the maximum transfer rate f <sub>mck</sub> = f <sub>clk</sub> Note 3		1.3	Mbps

**Note 1.** Transfer rate in the SNOOZE mode is 4800 bps only.

However, the SNOOZE mode cannot be used when FRQSEL4 = 1.

**Note 2.** The following conditions are required for low voltage interface when EVDD0 < VDD.

2.4 V ≤ EVDD0 < 2.7 V: MAX. 2.6 Mbps

1.8 V ≤ EVDD0 < 2.4 V: MAX. 1.3 Mbps

**Note 3.** The maximum operating frequencies of the CPU/peripheral hardware clock (f<sub>clk</sub>) are:

HS (high-speed main) mode: 32 MHz (2.7 V ≤ VDD ≤ 5.5 V)

16 MHz (2.4 V ≤ VDD ≤ 5.5 V)

**Caution** Select the TTL input buffer for the RxDq pin and the N-ch open drain output (VDD tolerance (for the 48-, 32-, 24-pin products)/EVDD tolerance (for the 64-, 36-pin products)) mode for the TxDq pin by using port input mode register g (PIMg) and port output mode register g (POMg). For VIH and VIL, see the DC characteristics with TTL input buffer selected.

**Remark 1.** Vb [V]: Communication line voltage

**Remark 2.** q: UART number (q = 0 to 2), g: PIM and POM number (g = 0, 1, 5, 7)

**Remark 3.** f<sub>mck</sub>: Serial array unit operation clock frequency

(Operation clock to be set by the CKSmn bit of serial mode register mn (SMRmn). m: Unit number,

n: Channel number (mn = 00 to 03, 10, 11)

**Remark 4.** UART2 cannot communicate at different potential when bit 1 (PIOR01) of peripheral I/O redirection register 0 (PIOR0) is 1.

**(5) Communication at different potential (1.8 V, 2.5 V, 3 V) (UART mode)****(TA = -40 to +105°C, 2.4 V ≤ EVDD0 ≤ VDD ≤ 5.5 V, VSS = EVSS0 = 0 V)****(2/2)**

Parameter	Symbol	Conditions	HS (high-speed main) mode		Unit	
			MIN.	MAX.		
Transfer rate		transmission	4.0 V ≤ EVDD0 ≤ 5.5 V, 2.7 V ≤ Vb ≤ 4.0 V		Note 1	bps
			Theoretical value of the maximum transfer rate Cb = 50 pF, Rb = 1.4 kΩ, Vb = 2.7 V		2.6 Note 2	Mbps
		2.7 V ≤ EVDD0 < 4.0 V, 2.3 V ≤ Vb ≤ 2.7 V		Note 3	bps	
		Theoretical value of the maximum transfer rate Cb = 50 pF, Rb = 2.7 kΩ, Vb = 2.3 V		1.2 Note 4	Mbps	
		2.4 V ≤ EVDD0 < 3.3 V, 1.6 V ≤ Vb ≤ 2.0 V		Note 5	bps	
		Theoretical value of the maximum transfer rate Cb = 50 pF, Rb = 5.5 kΩ, Vb = 1.6 V		0.43 Note 6	Mbps	

**Note 1.** The smaller maximum transfer rate derived by using  $f_{MCK}/6$  or the following expression is the valid maximum transfer rate. Expression for calculating the transfer rate when  $4.0\text{ V} \leq \text{EVDD0} \leq 5.5\text{ V}$  and  $2.7\text{ V} \leq V_b \leq 4.0\text{ V}$

$$\text{Maximum transfer rate} = \frac{1}{\{-C_b \times R_b \times \ln(1 - \frac{2.2}{V_b})\} \times 3} \text{ [bps]}$$

$$\text{Baud rate error (theoretical value)} = \frac{\frac{1}{\text{Transfer rate} \times 2} - \{-C_b \times R_b \times \ln(1 - \frac{2.2}{V_b})\}}{(\frac{1}{\text{Transfer rate}}) \times \text{Number of transferred bits}} \times 100 \text{ [%]}$$

\* This value is the theoretical value of the relative difference between the transmission and reception sides.

**Note 2.** This value as an example is calculated when the conditions described in the "Conditions" column are met. Refer to **Note 1** above to calculate the maximum transfer rate under conditions of the customer.

**Note 3.** The smaller maximum transfer rate derived by using  $f_{MCK}/6$  or the following expression is the valid maximum transfer rate.

Expression for calculating the transfer rate when  $2.7\text{ V} \leq \text{EVDD0} < 4.0\text{ V}$  and  $2.3\text{ V} \leq V_b \leq 2.7\text{ V}$

$$\text{Maximum transfer rate} = \frac{1}{\{-C_b \times R_b \times \ln(1 - \frac{2.0}{V_b})\} \times 3} \text{ [bps]}$$

$$\text{Baud rate error (theoretical value)} = \frac{\frac{1}{\text{Transfer rate} \times 2} - \{-C_b \times R_b \times \ln(1 - \frac{2.0}{V_b})\}}{(\frac{1}{\text{Transfer rate}}) \times \text{Number of transferred bits}} \times 100 \text{ [%]}$$

\* This value is the theoretical value of the relative difference between the transmission and reception sides.

**Note 4.** This value as an example is calculated when the conditions described in the "Conditions" column are met. Refer to **Note 3** above to calculate the maximum transfer rate under conditions of the customer.

**Note 5.** The smaller maximum transfer rate derived by using  $f_{mck}/6$  or the following expression is the valid maximum transfer rate.

Expression for calculating the transfer rate when  $2.4\text{ V} \leq EV_{DD} < 3.3\text{ V}$  and  $1.6\text{ V} \leq V_b \leq 2.0\text{ V}$

$$\text{Maximum transfer rate} = \frac{1}{\{-C_b \times R_b \times \ln(1 - \frac{1.5}{V_b})\} \times 3} \text{ [bps]}$$

$$\text{Baud rate error (theoretical value)} = \frac{\frac{1}{\text{Transfer rate} \times 2} - \{-C_b \times R_b \times \ln(1 - \frac{1.5}{V_b})\}}{\left(\frac{1}{\text{Transfer rate}}\right) \times \text{Number of transferred bits}} \times 100 \text{ [%]}$$

\* This value is the theoretical value of the relative difference between the transmission and reception sides.

**Note 6.** This value as an example is calculated when the conditions described in the "Conditions" column are met. Refer to **Note 5** above to calculate the maximum transfer rate under conditions of the customer.

**Caution** Select the TTL input buffer for the RxDq pin and the N-ch open drain output ( $V_{DD}$  tolerance (for the 48-, 32-, 24-pin products)/ $EV_{DD}$  tolerance (for the 64-, 36-pin products)) mode for the TxDq pin by using port input mode register g (PIMg) and port output mode register g (POMg). For  $V_{IH}$  and  $V_{IL}$ , see the DC characteristics with TTL input buffer selected.

(Remarks are listed on the next page.)

**UART mode connection diagram (during communication at different potential)**

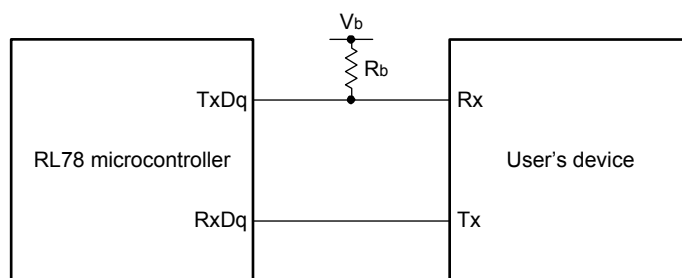

**UART mode bit width (during communication at different potential) (reference)**

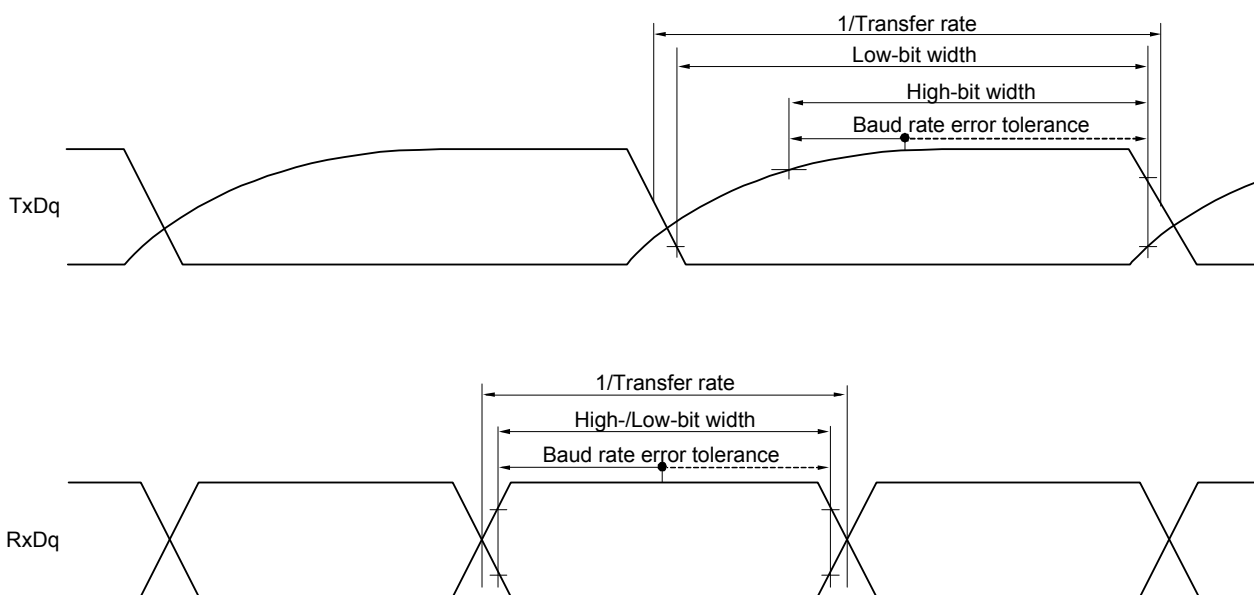

- Remark 1.**  $R_b[\Omega]$ : Communication line (TxDq) pull-up resistance,  
 $C_b[F]$ : Communication line (TxDq) load capacitance,  $V_b[V]$ : Communication line voltage
- Remark 2.** q: UART number (q = 0 to 2), g: PIM and POM number (g = 0, 1, 5, 7)
- Remark 3.**  $f_{mck}$ : Serial array unit operation clock frequency  
 (Operation clock to be set by the CKSmn bit of serial mode register mn (SMRmn).  
 m: Unit number, n: Channel number (mn = 00 to 03, 10, 11))
- Remark 4.** UART2 cannot communicate at different potential when bit 1 (PIOR01) of peripheral I/O redirection register 0 (PIOR0) is 1.



**(6) Communication at different potential (2.5 V, 3 V) (CSI mode) (master mode, SCKp... internal clock output)**  
**(TA = -40 to +105°C, 2.4 V ≤ EVDD0 ≤ VDD ≤ 5.5 V, VSS = EVSS0 = 0 V)**

Parameter	Symbol	Conditions	HS (high-speed main) mode		Unit
			MIN.	MAX.	
SCKp cycle time	tkCY1	tkCY1 ≥ 4/fCLK 4.0 V ≤ EVDD0 ≤ 5.5 V, 2.7 V ≤ Vb ≤ 4.0 V, Cb = 30 pF, Rb = 1.4 kΩ	600		ns
			1000		ns
			2300		ns
SCKp high-level width	tkH1	4.0 V ≤ EVDD0 ≤ 5.5 V, 2.7 V ≤ Vb ≤ 4.0 V, Cb = 30 pF, Rb = 1.4 kΩ	tkCY1/2 - 150		ns
		2.7 V ≤ EVDD0 < 4.0 V, 2.3 V ≤ Vb ≤ 2.7 V, Cb = 30 pF, Rb = 2.7 kΩ	tkCY1/2 - 340		ns
		2.4 V ≤ EVDD0 < 3.3 V, 1.6 V ≤ Vb ≤ 2.0 V, Cb = 30 pF, Rb = 5.5 kΩ	tkCY1/2 - 916		ns
SCKp low-level width	tkL1	4.0 V ≤ EVDD0 ≤ 5.5 V, 2.7 V ≤ Vb ≤ 4.0 V, Cb = 30 pF, Rb = 1.4 kΩ	tkCY1/2 - 24		ns
		2.7 V ≤ EVDD0 < 4.0 V, 2.3 V ≤ Vb ≤ 2.7 V, Cb = 30 pF, Rb = 2.7 kΩ	tkCY1/2 - 36		ns
		2.4 V ≤ EVDD0 < 3.3 V, 1.6 V ≤ Vb ≤ 2.0 V, Cb = 30 pF, Rb = 5.5 kΩ	tkCY1/2 - 100		ns

**Caution** Select the TTL input buffer for the SIp pin and the N-ch open drain output (VDD tolerance (for the 48-, 32-, 24-pin products)/EVDD tolerance (for the 64-, 36-pin products)) mode for the SOP pin and SCKp pin by using port input mode register g (PIMg) and port output mode register g (POMg). For VIH and VIL, see the DC characteristics with TTL input buffer selected.

(Remarks are listed two pages after the next page.)

**(6) Communication at different potential (1.8 V, 2.5 V, 3 V) (CSI mode) (master mode, SCKp... internal clock output)****(TA = -40 to +105°C, 1.8 V ≤ EVDD0 ≤ VDD ≤ 5.5 V, VSS = EVSS0 = 0 V)****(2/3)**

Parameter	Symbol	Conditions	HS (high-speed main) mode		Unit
			MIN.	MAX.	
Slp setup time (to SCKp↑) <sup>Note</sup>	tsIK1	4.0 V ≤ EVDD0 ≤ 5.5 V, 2.7 V ≤ Vb ≤ 4.0 V, Cb = 30 pF, Rb = 1.4 kΩ	162		ns
		2.7 V ≤ EVDD0 < 4.0 V, 2.3 V ≤ Vb ≤ 2.7 V, Cb = 30 pF, Rb = 2.7 kΩ	354		ns
		2.4 V ≤ EVDD0 < 3.3 V, 1.6 V ≤ Vb ≤ 2.0 V, Cb = 30 pF, Rb = 5.5 kΩ	958		ns
Slp hold time (from SCKp↑) <sup>Note</sup>	tkS11	4.0 V ≤ EVDD0 ≤ 5.5 V, 2.7 V ≤ Vb ≤ 4.0 V, Cb = 30 pF, Rb = 1.4 kΩ	38		ns
		2.7 V ≤ EVDD0 < 4.0 V, 2.3 V ≤ Vb ≤ 2.7 V, Cb = 30 pF, Rb = 2.7 kΩ	38		ns
		2.4 V ≤ EVDD0 < 3.3 V, 1.6 V ≤ Vb ≤ 2.0 V, Cb = 30 pF, Rb = 5.5 kΩ	38		ns
Delay time from SCKp↓ to SOp output <sup>Note</sup>	tkSO1	4.0 V ≤ EVDD0 ≤ 5.5 V, 2.7 V ≤ Vb ≤ 4.0 V, Cb = 30 pF, Rb = 1.4 kΩ		200	ns
		2.7 V ≤ EVDD0 < 4.0 V, 2.3 V ≤ Vb ≤ 2.7 V, Cb = 30 pF, Rb = 2.7 kΩ		390	ns
		2.4 V ≤ EVDD0 < 3.3 V, 1.6 V ≤ Vb ≤ 2.0 V, Cb = 30 pF, Rb = 5.5 kΩ		966	ns

**Note** When DAPmn = 0 and CKPmn = 0, or DAPmn = 1 and CKPmn = 1.

**Caution** Select the TTL input buffer for the Slp pin and the N-ch open drain output (VDD tolerance (for the 48-, 32-, 24-pin products)/EVDD tolerance (for the 64-, 36-pin products)) mode for the SOp pin and SCKp pin by using port input mode register g (PIMg) and port output mode register g (POMg). For VIH and VIL, see the DC characteristics with TTL input buffer selected.

(Remarks are listed on the page after the next page.)

**(6) Communication at different potential (1.8 V, 2.5 V, 3 V) (CSI mode) (master mode, SCKp... internal clock output)****(TA = -40 to +105°C, 1.8 V ≤ EVDD0 ≤ VDD ≤ 5.5 V, VSS = EVSS0 = 0 V)****(3/3)**

Parameter	Symbol	Conditions	HS (high-speed main) mode		Unit
			MIN.	MAX.	
Slp setup time (to SCKp↓) <sup>Note</sup>	tsIK1	4.0 V ≤ EVDD0 ≤ 5.5 V, 2.7 V ≤ Vb ≤ 4.0 V, Cb = 30 pF, Rb = 1.4 kΩ	88		ns
		2.7 V ≤ EVDD0 < 4.0 V, 2.3 V ≤ Vb ≤ 2.7 V, Cb = 30 pF, Rb = 2.7 kΩ	88		ns
		2.4 V ≤ EVDD0 < 3.3 V, 1.6 V ≤ Vb ≤ 2.0 V, Cb = 30 pF, Rb = 5.5 kΩ	220		ns
Slp hold time (from SCKp↓) <sup>Note</sup>	tkS11	4.0 V ≤ EVDD0 ≤ 5.5 V, 2.7 V ≤ Vb ≤ 4.0 V, Cb = 30 pF, Rb = 1.4 kΩ	38		ns
		2.7 V ≤ EVDD0 < 4.0 V, 2.3 V ≤ Vb ≤ 2.7 V, Cb = 30 pF, Rb = 2.7 kΩ	38		ns
		2.4 V ≤ EVDD0 < 3.3 V, 1.6 V ≤ Vb ≤ 2.0 V, Cb = 30 pF, Rb = 5.5 kΩ	38		ns
Delay time from SCKp↑ to SOp output <sup>Note</sup>	tkSO1	4.0 V ≤ EVDD0 ≤ 5.5 V, 2.7 V ≤ Vb ≤ 4.0 V, Cb = 30 pF, Rb = 1.4 kΩ		50	ns
		2.7 V ≤ EVDD0 < 4.0 V, 2.3 V ≤ Vb ≤ 2.7 V, Cb = 30 pF, Rb = 2.7 kΩ		50	ns
		2.4 V ≤ EVDD0 < 3.3 V, 1.6 V ≤ Vb ≤ 2.0 V, Cb = 30 pF, Rb = 5.5 kΩ		50	ns

**Note** When DAPmn = 0 and CKPmn = 1, or DAPmn = 1 and CKPmn = 0.

**Caution** Select the TTL input buffer for the Slp pin and the N-ch open drain output (VDD tolerance (for the 48-, 32-, 24-pin products)/EVDD tolerance (for the 64-, 36-pin products)) mode for the SOp pin and SCKp pin by using port input mode register g (PIMg) and port output mode register g (POMg). For VIH and VIL, see the DC characteristics with TTL input buffer selected.

(Remarks are listed on the next page.)

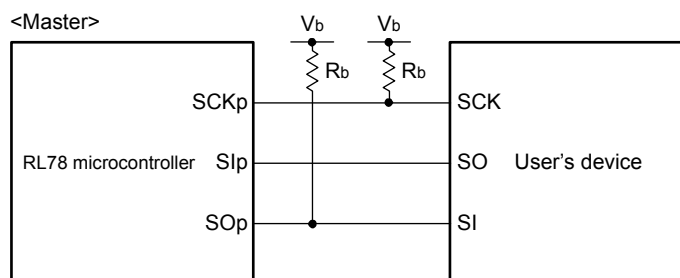
**CSI mode connection diagram (during communication at different potential)**

**Remark 1.**  $R_b[\Omega]$ : Communication line (SCK<sub>p</sub>, SOp) pull-up resistance,  $C_b[F]$ : Communication line (SCK<sub>p</sub>, SOp) load capacitance,  $V_b[V]$ : Communication line voltage

**Remark 2.** p: CSI number (p = 00, 01, 10, 20), m: Unit number (m = 0, 1), n: Channel number (n = 0 to 3), g: PIM and POM number (g = 0, 1, 3, 5, 7)

**Remark 3.**  $f_{MCK}$ : Serial array unit operation clock frequency  
(Operation clock to be set by the CKSmn bit of serial mode register mn (SMRmn). m: Unit number, n: Channel number (mn = 00))

**Remark 4.** CSI01 of 48-, 64-pin products, and CSI11 and CSI21 cannot communicate at different potential. Use other CSI for communication at different potential.

**CSI mode serial transfer timing (master mode) (during communication at different potential)  
(When DAPmn = 0 and CKPmn = 0, or DAPmn = 1 and CKPmn = 1.)**

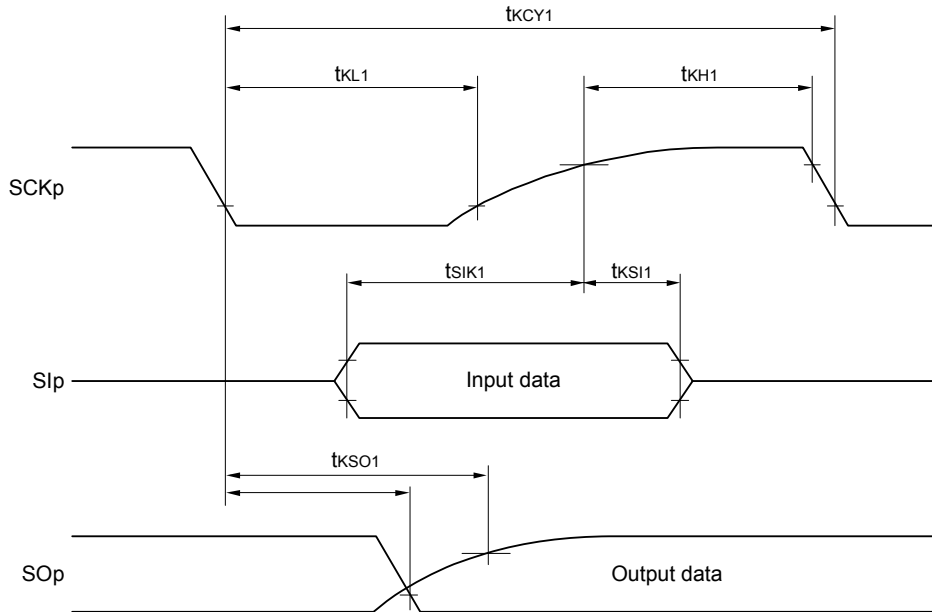

**CSI mode serial transfer timing (master mode) (during communication at different potential)  
(When DAPmn = 0 and CKPmn = 1, or DAPmn = 1 and CKPmn = 0.)**

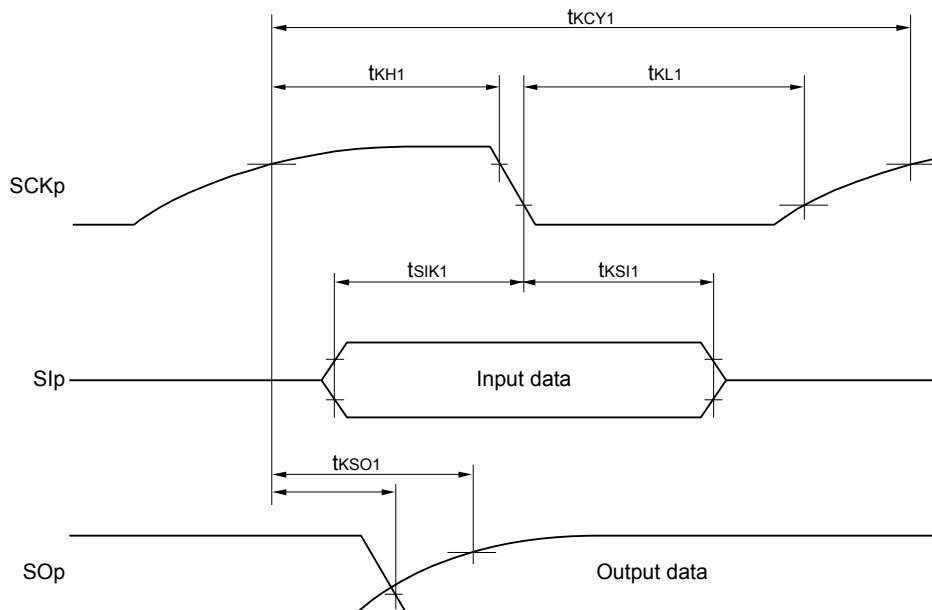

**Remark 1.** p: CSI number (p = 00, 01, 10, 20), m: Unit number (m = 0, 1), n: Channel number (n = 0 to 3),  
g: PIM and POM number (g = 0, 1, 3, 5, 7)

**Remark 2.** CSI01 of 48-, 64-pin products, and CSI11 and CSI21 cannot communicate at different potential. Use other CSI for communication at different potential.

**Remark 3.** Remark 3. fMCK: Serial array unit operation clock frequency  
(Operation clock to be set by the CKSmn bit of serial mode register mn (SMRmn). m: Unit number (m = 0, 1),  
n: Channel number (n = 0, 2), mn = 00, 01, 02, 10)

**(7) Communication at different potential (1.8 V, 2.5 V, 3 V) (CSI mode) (slave mode, SCKp... external clock input)****(TA = -40 to +105°C, 2.4 V ≤ EVDD0 ≤ VDD ≤ 5.5 V, VSS = EVSS0 = 0 V)**

Parameter	Symbol	Conditions	HS (high-speed main) mode		Unit	
			MIN.	MAX.		
SCKp cycle time <sup>Note 1</sup>	tkcy2	4.0 V ≤ EVDD0 ≤ 5.5 V, 2.7 V ≤ Vb ≤ 4.0 V	24 MHz < fmck	28/fmck		ns
			20 MHz < fmck ≤ 24 MHz	24/fmck		ns
			8 MHz < fmck ≤ 20 MHz	20/fmck		ns
			4 MHz < fmck ≤ 8 MHz	16/fmck		ns
			fmck ≤ 4 MHz	12/fmck		ns
		2.7 V ≤ EVDD0 < 4.0 V, 2.3 V ≤ Vb ≤ 2.7 V	24 MHz < fmck	40/fmck		ns
			20 MHz < fmck ≤ 24 MHz	32/fmck		ns
			16 MHz < fmck ≤ 20 MHz	28/fmck		ns
			8 MHz < fmck ≤ 16 MHz	24/fmck		ns
			4 MHz < fmck ≤ 8 MHz	16/fmck		ns
		2.4 V ≤ EVDD0 < 3.3 V, 1.6 V ≤ Vb ≤ 2.0 V	24 MHz < fmck	96/fmck		ns
			20 MHz < fmck ≤ 24 MHz	72/fmck		ns
			16 MHz < fmck ≤ 20 MHz	64/fmck		ns
			8 MHz < fmck ≤ 16 MHz	52/fmck		ns
			4 MHz < fmck ≤ 8 MHz	32/fmck		ns
		fmck ≤ 4 MHz	20/fmck		ns	
		SCKp high-/low-level width		tkcy2/2 - 24		ns
		4.0 V ≤ EVDD0 ≤ 5.5 V, 2.7 V ≤ Vb ≤ 4.0 V				
		2.7 V ≤ EVDD0 < 4.0 V, 2.3 V ≤ Vb ≤ 2.7 V				
		2.4 V ≤ EVDD0 < 3.3 V, 1.6 V ≤ Vb ≤ 2.0 V		tkcy2/2 - 100		ns
Slp setup time (to SCKp↑) <sup>Note 2</sup>	tslk2	2.7 V ≤ EVDD0 < 4.0 V, 2.3 V ≤ Vb ≤ 2.7 V	1/fmck + 40		ns	
		2.4 V ≤ EVDD0 < 3.3 V, 1.6 V ≤ Vb ≤ 2.0 V	1/fmck + 60		ns	
Slp hold time (from SCKp↑) <sup>Note 3</sup>	tksl2		1/fmck + 62		ns	
Delay time from SCKp↓ to SOP output <sup>Note 4</sup>	tkso2	4.0 V ≤ EVDD0 ≤ 5.5 V, 2.7 V ≤ Vb ≤ 4.0 V, Cb = 30 pF, Rb = 1.4 kΩ		2/fmck + 240	ns	
		2.7 V ≤ EVDD0 < 4.0 V, 2.3 V ≤ Vb ≤ 2.7 V, Cb = 30 pF, Rb = 2.7 kΩ		2/fmck + 428	ns	
		2.4 V ≤ EVDD0 < 3.3 V, 1.6 V ≤ Vb ≤ 2.0 V, Cb = 30 pF, Rv = 5.5 kΩ		2/fmck + 1146	ns	

(Notes and Remarks are listed on the next page.)

- Note 1.** Transfer rate in the SNOOZE mode: MAX. 1 Mbps
- Note 2.** When DAPmn = 0 and CKPmn = 0, or DAPmn = 1 and CKPmn = 1. The SIp setup time becomes “to SCKp↓” when DAPmn = 0 and CKPmn = 1, or DAPmn = 1 and CKPmn = 0.
- Note 3.** When DAPmn = 0 and CKPmn = 0, or DAPmn = 1 and CKPmn = 1. The SIp hold time becomes “from SCKp↓” when DAPmn = 0 and CKPmn = 1, or DAPmn = 1 and CKPmn = 0.
- Note 4.** When DAPmn = 0 and CKPmn = 0, or DAPmn = 1 and CKPmn = 1. The delay time to SOp output becomes “from SCKp↑” when DAPmn = 0 and CKPmn = 1, or DAPmn = 1 and CKPmn = 0.
- Note 5.** Select the TTL input buffer for the SIp pin and SCKp pin, and the N-ch open drain output (VDD tolerance (for the 48, 32, 24-pin products)/EVDD tolerance (for the 64, 36-pin products)) mode for the SOp pin by using port input mode register g (PIMg) and port output mode register g (POMg). For VIH and VIL, see the DC characteristics with TTL input buffer selected.

**CSI mode connection diagram (during communication at different potential)**

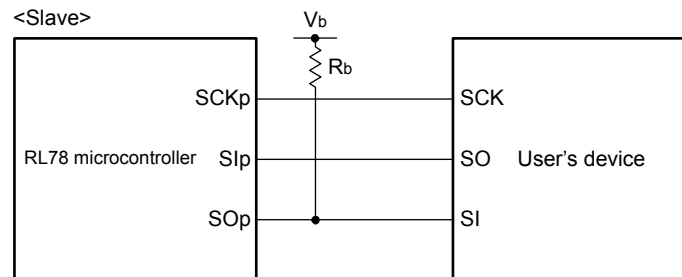

- Remark 1.** Rb[Ω]: Communication line (SO<sub>p</sub>) pull-up resistance, C<sub>b</sub>[F]: Communication line (SO<sub>p</sub>) load capacitance, V<sub>b</sub>[V]: Communication line voltage
- Remark 2.** p: CSI number (p = 00, 01, 10, 20), m: Unit number (m = 0, 1), n: Channel number (n = 0 to 3), g: PIM and POM number (g = 0, 1, 3, 5, 7)
- Remark 3.** f<sub>MCK</sub>: Serial array unit operation clock frequency  
(Operation clock to be set by the CKSmn bit of serial mode register mn (SMRmn).  
m: Unit number, n: Channel number (mn = 00, 01, 02, 10))
- Remark 4.** CSI01 of 48-, 64-pin products, and CSI11 and CSI21 cannot communicate at different potential. Use other CSI for communication at different potential.  
Also, communication at different potential cannot be performed during clock synchronous serial communication with the slave select function.

**CSI mode serial transfer timing (slave mode) (during communication at different potential)**  
**(When DAPmn = 0 and CKPmn = 0, or DAPmn = 1 and CKPmn = 1.)**

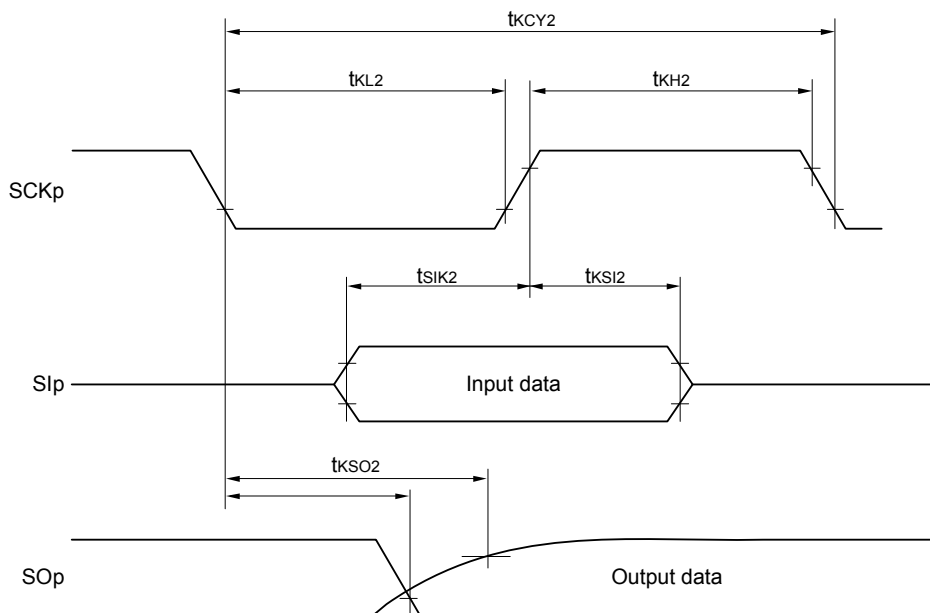

**CSI mode serial transfer timing (slave mode) (during communication at different potential)**  
**(When DAPmn = 0 and CKPmn = 1, or DAPmn = 1 and CKPmn = 0.)**

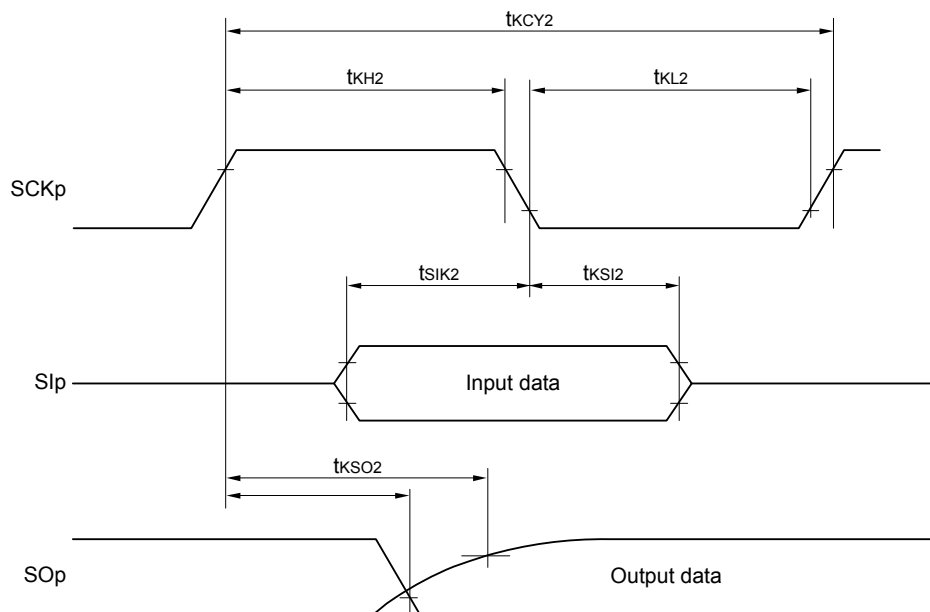

**Remark 1.** p: CSI number (p = 00, 01, 10, 20), m: Unit number (m = 0, 1), n: Channel number (n = 0 to 3),  
 g: PIM and POM number (g = 0, 1, 3, 5, 7)

**Remark 2.** CSI01 of 48-, 64-pin products, and CSI11 and CSI21 cannot communicate at different potential. Use other CSI for communication at different potential.  
 Also, communication at different potential cannot be performed during clock synchronous serial communication with the slave select function.



**(8) Communication at different potential (1.8 V, 2.5 V, 3 V) (simplified I<sup>2</sup>C mode)****(TA = -40 to +105°C, 2.4 V ≤ EV<sub>DD0</sub> ≤ V<sub>DD</sub> ≤ 5.5 V, V<sub>SS</sub> = EV<sub>SS0</sub> = 0 V)****(1/2)**

Parameter	Symbol	Conditions	HS (high-speed main) mode		Unit
			MIN.	MAX.	
SCLr clock frequency	f <sub>SCL</sub>	4.0 V ≤ EV <sub>DD0</sub> ≤ 5.5 V, 2.7 V ≤ V <sub>b</sub> ≤ 4.0 V, C <sub>b</sub> = 50 pF, R <sub>b</sub> = 2.7 kΩ		400 Note 1	kHz
		2.7 V ≤ EV <sub>DD0</sub> < 4.0 V, 2.3 V ≤ V <sub>b</sub> ≤ 2.7 V, C <sub>b</sub> = 50 pF, R <sub>b</sub> = 2.7 kΩ		400 Note 1	kHz
		4.0 V ≤ EV <sub>DD0</sub> ≤ 5.5 V, 2.7 V ≤ V <sub>b</sub> ≤ 4.0 V, C <sub>b</sub> = 100 pF, R <sub>b</sub> = 2.8 kΩ		100 Note 1	kHz
		2.7 V ≤ EV <sub>DD0</sub> < 4.0 V, 2.3 V ≤ V <sub>b</sub> ≤ 2.7 V, C <sub>b</sub> = 100 pF, R <sub>b</sub> = 2.7 kΩ		100 Note 1	kHz
		2.4 V ≤ EV <sub>DD0</sub> < 3.3 V, 1.6 V ≤ V <sub>b</sub> ≤ 2.0 V, C <sub>b</sub> = 100 pF, R <sub>b</sub> = 5.5 kΩ		100 Note 1	kHz
Hold time when SCLr = "L"	t <sub>LOW</sub>	4.0 V ≤ EV <sub>DD0</sub> ≤ 5.5 V, 2.7 V ≤ V <sub>b</sub> ≤ 4.0 V, C <sub>b</sub> = 50 pF, R <sub>b</sub> = 2.7 kΩ	1200		ns
		2.7 V ≤ EV <sub>DD0</sub> < 4.0 V, 2.3 V ≤ V <sub>b</sub> ≤ 2.7 V, C <sub>b</sub> = 50 pF, R <sub>b</sub> = 2.7 kΩ	1200		ns
		4.0 V ≤ EV <sub>DD0</sub> ≤ 5.5 V, 2.7 V ≤ V <sub>b</sub> ≤ 4.0 V, C <sub>b</sub> = 100 pF, R <sub>b</sub> = 2.8 kΩ	4600		ns
		2.7 V ≤ EV <sub>DD0</sub> < 4.0 V, 2.3 V ≤ V <sub>b</sub> ≤ 2.7 V, C <sub>b</sub> = 100 pF, R <sub>b</sub> = 2.7 kΩ	4600		ns
		2.4 V ≤ EV <sub>DD0</sub> < 3.3 V, 1.6 V ≤ V <sub>b</sub> ≤ 2.0 V, C <sub>b</sub> = 100 pF, R <sub>b</sub> = 5.5 kΩ	4650		ns
Hold time when SCLr = "H"	t <sub>HIGH</sub>	4.0 V ≤ EV <sub>DD0</sub> ≤ 5.5 V, 2.7 V ≤ V <sub>b</sub> ≤ 4.0 V, C <sub>b</sub> = 50 pF, R <sub>b</sub> = 2.7 kΩ	620		ns
		2.7 V ≤ EV <sub>DD0</sub> < 4.0 V, 2.3 V ≤ V <sub>b</sub> ≤ 2.7 V, C <sub>b</sub> = 50 pF, R <sub>b</sub> = 2.7 kΩ	500		ns
		4.0 V ≤ EV <sub>DD0</sub> ≤ 5.5 V, 2.7 V ≤ V <sub>b</sub> ≤ 4.0 V, C <sub>b</sub> = 100 pF, R <sub>b</sub> = 2.8 kΩ	2700		ns
		2.7 V ≤ EV <sub>DD0</sub> < 4.0 V, 2.3 V ≤ V <sub>b</sub> ≤ 2.7 V, C <sub>b</sub> = 100 pF, R <sub>b</sub> = 2.7 kΩ	2400		ns
		2.4 V ≤ EV <sub>DD0</sub> < 3.3 V, 1.6 V ≤ V <sub>b</sub> ≤ 2.0 V, C <sub>b</sub> = 100 pF, R <sub>b</sub> = 5.5 kΩ	1830		ns

**(8) Communication at different potential (1.8 V, 2.5 V, 3 V) (simplified I<sup>2</sup>C mode)****(TA = -40 to +105°C, 2.4 V ≤ EV<sub>DD0</sub> ≤ V<sub>DD</sub> ≤ 5.5 V, V<sub>SS</sub> = EV<sub>SS0</sub> = 0 V)****(2/2)**

Parameter	Symbol	Conditions	HS (high-speed main) mode		Unit
			MIN.	MAX.	
Data setup time (reception)	t <sub>SU:DAT</sub>	4.0 V ≤ EV <sub>DD0</sub> ≤ 5.5 V, 2.7 V ≤ V <sub>b</sub> ≤ 4.0 V, C <sub>b</sub> = 50 pF, R <sub>b</sub> = 2.7 kΩ	1/f <sub>MCK</sub> + 340 Note 2		ns
		2.7 V ≤ EV <sub>DD0</sub> < 4.0 V, 2.3 V ≤ V <sub>b</sub> ≤ 2.7 V, C <sub>b</sub> = 50 pF, R <sub>b</sub> = 2.7 kΩ	1/f <sub>MCK</sub> + 340 Note 2		ns
		4.0 V ≤ EV <sub>DD0</sub> ≤ 5.5 V, 2.7 V ≤ V <sub>b</sub> ≤ 4.0 V, C <sub>b</sub> = 100 pF, R <sub>b</sub> = 2.8 kΩ	1/f <sub>MCK</sub> + 760 Note 2		ns
		2.7 V ≤ EV <sub>DD0</sub> < 4.0 V, 2.3 V ≤ V <sub>b</sub> ≤ 2.7 V, C <sub>b</sub> = 100 pF, R <sub>b</sub> = 2.7 kΩ	1/f <sub>MCK</sub> + 760 Note 2		ns
		2.4 V ≤ EV <sub>DD0</sub> < 3.3 V, 1.6 V ≤ V <sub>b</sub> ≤ 2.0 V, C <sub>b</sub> = 100 pF, R <sub>b</sub> = 5.5 kΩ	1/f <sub>MCK</sub> + 570 Note 2		ns
Data hold time (transmission)	t <sub>HD:DAT</sub>	4.0 V ≤ EV <sub>DD0</sub> ≤ 5.5 V, 2.7 V ≤ V <sub>b</sub> ≤ 4.0 V, C <sub>b</sub> = 50 pF, R <sub>b</sub> = 2.7 kΩ	0	770	ns
		2.7 V ≤ EV <sub>DD0</sub> < 4.0 V, 2.3 V ≤ V <sub>b</sub> ≤ 2.7 V, C <sub>b</sub> = 50 pF, R <sub>b</sub> = 2.7 kΩ	0	770	ns
		4.0 V ≤ EV <sub>DD0</sub> ≤ 5.5 V, 2.7 V ≤ V <sub>b</sub> ≤ 4.0 V, C <sub>b</sub> = 100 pF, R <sub>b</sub> = 2.8 kΩ	0	1420	ns
		2.7 V ≤ EV <sub>DD0</sub> < 4.0 V, 2.3 V ≤ V <sub>b</sub> ≤ 2.7 V, C <sub>b</sub> = 100 pF, R <sub>b</sub> = 2.7 kΩ	0	1420	ns
		2.4 V ≤ EV <sub>DD0</sub> < 3.3 V, 1.6 V ≤ V <sub>b</sub> ≤ 2.0 V, C <sub>b</sub> = 100 pF, R <sub>b</sub> = 5.5 kΩ	0	1215	ns

**Note 1.** The value must also be equal to or less than f<sub>MCK</sub>/4.

**Note 2.** Set the f<sub>MCK</sub> value to keep the hold time of SCLr = "L" and SCLr = "H".

**Caution** Select the TTL input buffer and the N-ch open drain output (V<sub>DD</sub> tolerance (for the 48-, 32-, 24-pin products)/EV<sub>DD</sub> tolerance (for the 64-, 36-pin products)) mode for the SDAr pin and the N-ch open drain output (V<sub>DD</sub> tolerance (for the 48-, 32-, 24-pin products)/EV<sub>DD</sub> tolerance (for the 64-, 36-pin products)) mode for the SCLr pin by using port input mode register g (PIMg) and port output mode register g (POMg). For V<sub>IH</sub> and V<sub>IL</sub>, see the DC characteristics with TTL input buffer selected.

(Remarks are listed on the next page.)

**Simplified I<sup>2</sup>C mode connection diagram (during communication at different potential)**

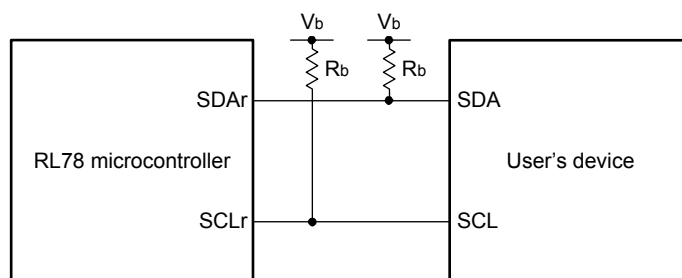

**Simplified I<sup>2</sup>C mode serial transfer timing (during communication at different potential)**

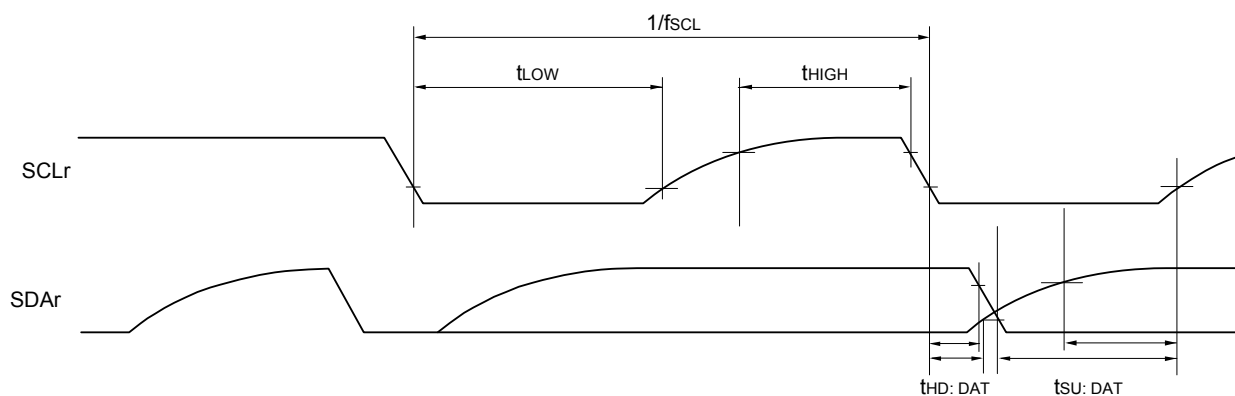

- Remark 1.**  $R_b[\Omega]$ : Communication line (SDAr, SCLr) pull-up resistance,  $C_b[F]$ : Communication line (SDAr, SCLr) load capacitance,  $V_b[V]$ : Communication line voltage
- Remark 2.** r: IIC number (r = 00, 01, 10, 11, 20), g: PIM, POM number (g = 0, 1, 3, 5, 7)
- Remark 3.**  $f_{MCK}$ : Serial array unit operation clock frequency  
(Operation clock to be set by the CKSmn bit of serial mode register mn (SMRmn). m: Unit number (m = 0, 1), n: Channel number (n = 0, 2), mn = 00, 01, 02, 10)

### 3.5.2 Serial interface IICA

(TA = -40 to +105°C, 2.4 V ≤ EVDD0 ≤ VDD ≤ 5.5 V, VSS = EVSS0 = 0 V)

Parameter	Symbol	Conditions	HS (high-speed main) mode				Unit
			Standard mode		Fast mode		
			MIN.	MAX.	MIN.	MAX.	
SCLA0 clock frequency	f <sub>SCL</sub>	Fast mode: f <sub>CLK</sub> ≥ 3.5 MHz	—	—	0	400	kHz
		Standard mode: f <sub>CLK</sub> ≥ 1 MHz	0	100	—	—	kHz
Setup time of restart condition	t <sub>SU: STA</sub>		4.7		0.6		μs
Hold time <sup>Note 1</sup>	t <sub>HD: STA</sub>		4.0		0.6		μs
Hold time when SCLA0 = "L"	t <sub>LOW</sub>		4.7		1.3		μs
Hold time when SCLA0 = "H"	t <sub>HIGH</sub>		4.0		0.6		μs
Data setup time (reception)	t <sub>SU: DAT</sub>		250		100		ns
Data hold time (transmission) <sup>Note 2</sup>	t <sub>HD: DAT</sub>		0	3.45	0	0.9	μs
Setup time of stop condition	t <sub>SU: STO</sub>		4.0		0.6		μs
Bus-free time	t <sub>BUF</sub>		4.7		1.3		μs

**Note 1.** The first clock pulse is generated after this period when the start/restart condition is detected.

**Note 2.** The maximum value (MAX.) of t<sub>HD: DAT</sub> is during normal transfer and a wait state is inserted in the ACK (acknowledge) timing.

**Caution** The values in the above table are applied even when bit 2 (PIOR02) in the peripheral I/O redirection register 0 (PIOR0) is 1. At this time, the pin characteristics (I<sub>OH1</sub>, I<sub>OL1</sub>, V<sub>OH1</sub>, V<sub>OL1</sub>) must satisfy the values in the redirect destination.

**Remark** The maximum value of C<sub>b</sub> (communication line capacitance) and the value of R<sub>b</sub> (communication line pull-up resistor) at that time in each mode are as follows.

Standard mode: C<sub>b</sub> = 400 pF, R<sub>b</sub> = 2.7 kΩ

Fast mode: C<sub>b</sub> = 320 pF, R<sub>b</sub> = 1.1 kΩ

IICA serial transfer timing

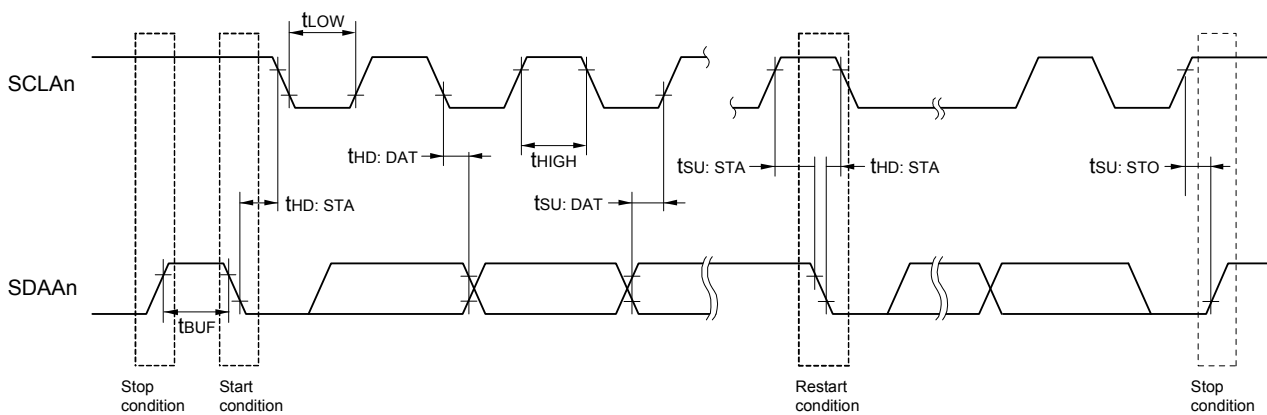

**Remark** n = 0, 1

## 3.6 Analog Characteristics

### 3.6.1 A/D converter characteristics

#### Classification of A/D converter characteristics

Input channel	Reference Voltage	Reference voltage (+) = AVREFP Reference voltage (-) = AVREFM	Reference voltage (+) = VDD Reference voltage (-) = VSS	Reference voltage (+) = VBGR Reference voltage (-) = AVREFM
ANI0 to ANI7		Refer to 3.6.1 (1).	Refer to 3.6.1 (3).	Refer to 3.6.1 (4).
ANI16 to ANI24		Refer to 3.6.1 (2).		
Internal reference voltage Temperature sensor output voltage		Refer to 3.6.1 (1).		

(1) When reference voltage (+) = AVREFP/ANI0 (ADREFP1 = 0, ADREFP0 = 1), reference voltage (-) = AVREFM/ANI1 (ADREFM = 1), target pin: ANI2 to ANI7, internal reference voltage, and temperature sensor output voltage

(TA = -40 to +105°C, 2.4 V ≤ AVREFP ≤ VDD ≤ 5.5 V, VSS = 0 V, Reference voltage (+) = AVREFP,  
Reference voltage (-) = AVREFM = 0 V)

Parameter	Symbol	Conditions	MIN.	TYP.	MAX.	Unit
Resolution	RES		8		10	bit
Overall error Note 1	AINL	10-bit resolution AVREFP = VDD Note 3	2.4 V ≤ AVREFP ≤ 5.5 V	1.2	±3.5	LSB
Conversion time	tCONV	10-bit resolution Target pin: ANI2 to ANI14	3.6 V ≤ VDD ≤ 5.5 V	2.125	39	μs
			2.7 V ≤ VDD ≤ 5.5 V	3.1875	39	μs
			2.4 V ≤ VDD ≤ 5.5 V	17	39	μs
		10-bit resolution Target pin: Internal reference voltage, and temperature sensor output voltage (HS (high-speed main) mode)	3.6 V ≤ VDD ≤ 5.5 V	2.375	39	μs
			2.7 V ≤ VDD ≤ 5.5 V	3.5625	39	μs
			2.4 V ≤ VDD ≤ 5.5 V	17	39	μs
Zero-scale error Notes 1, 2	EZS	10-bit resolution AVREFP = VDD Note 3	2.4 V ≤ AVREFP ≤ 5.5 V		±0.25	%FSR
Full-scale error Notes 1, 2	EFS	10-bit resolution AVREFP = VDD Note 3	2.4 V ≤ AVREFP ≤ 5.5 V		±0.25	%FSR
Integral linearity error Note 1	ILE	10-bit resolution AVREFP = VDD Note 3	2.4 V ≤ AVREFP ≤ 5.5 V		±2.5	LSB
Differential linearity error Note 1	DLE	10-bit resolution AVREFP = VDD Note 3	2.4 V ≤ AVREFP ≤ 5.5 V		±1.5	LSB
Analog input voltage	VAIN	ANI2 to ANI7	0		AVREFP	V
		Internal reference voltage output (2.4 V ≤ VDD ≤ 5.5 V, HS (high-speed main) mode)			VBGR Note 4	V
		Temperature sensor output voltage (2.4 V ≤ VDD ≤ 5.5 V, HS (high-speed main) mode)			VTMPS25 Note 4	V

**Note 1.** Excludes quantization error (±1/2 LSB).

**Note 2.** This value is indicated as a ratio (%FSR) to the full-scale value.

**Note 3.** When AVREFP < VDD, the MAX. values are as follows.

Overall error: Add ±1.0 LSB to the MAX. value when AVREFP = VDD.

Zero-scale error/Full-scale error: Add ±0.05%FSR to the MAX. value when AVREFP = VDD.

Integral linearity error/ Differential linearity error: Add ±0.5 LSB to the MAX. value when AVREFP = VDD.

**Note 4.** Refer to 3.6.2 Temperature sensor characteristics/internal reference voltage characteristic.

(2) When reference voltage (+) =  $AV_{REFP}/ANI0$  ( $ADREFP1 = 0$ ,  $ADREFP0 = 1$ ), reference voltage (-) =  $AV_{REFM}/ANI1$  ( $ADREFM = 1$ ), target pin: ANI16 to ANI24

(TA = -40 to +105°C,  $2.4\text{ V} \leq EV_{DD0} \leq V_{DD} \leq 5.5\text{ V}$ ,  $2.4\text{ V} \leq AV_{REFP} \leq V_{DD} \leq 5.5\text{ V}$ ,

VSS = EVSS0 = 0 V, Reference voltage (+) =  $AV_{REFP}$ , Reference voltage (-) =  $AV_{REFM} = 0\text{ V}$ )

Parameter	Symbol	Conditions		MIN.	TYP.	MAX.	Unit
Resolution	RES			8		10	bit
Overall error Note 1	AINL	10-bit resolution $EV_{DD0} \leq AV_{REFP} = V_{DD}$ Notes 3, 4	$2.4\text{ V} \leq AV_{REFP} \leq 5.5\text{ V}$		1.2	$\pm 5.0$	LSB
Conversion time	tCONV	10-bit resolution Target ANI pin: ANI16 to ANI20	$3.6\text{ V} \leq V_{DD} \leq 5.5\text{ V}$	2.125		39	$\mu\text{s}$
			$2.7\text{ V} \leq V_{DD} \leq 5.5\text{ V}$	3.1875		39	$\mu\text{s}$
			$2.4\text{ V} \leq V_{DD} \leq 5.5\text{ V}$	17		39	$\mu\text{s}$
Zero-scale error Notes 1, 2	E <sub>ZS</sub>	10-bit resolution $EV_{DD0} \leq AV_{REFP} = V_{DD}$ Notes 3, 4	$2.4\text{ V} \leq AV_{REFP} \leq 5.5\text{ V}$			$\pm 0.35$	%FSR
Full-scale error Notes 1, 2	E <sub>FS</sub>	10-bit resolution $EV_{DD0} \leq AV_{REFP} = V_{DD}$ Notes 3, 4	$2.4\text{ V} \leq AV_{REFP} \leq 5.5\text{ V}$			$\pm 0.35$	%FSR
Integral linearity error Note 1	ILE	10-bit resolution $EV_{DD0} \leq AV_{REFP} = V_{DD}$ Notes 3, 4	$2.4\text{ V} \leq AV_{REFP} \leq 5.5\text{ V}$			$\pm 3.5$	LSB
Differential linearity error Note 1	DLE	10-bit resolution $EV_{DD0} \leq AV_{REFP} = V_{DD}$ Notes 3, 4	$2.4\text{ V} \leq AV_{REFP} \leq 5.5\text{ V}$			$\pm 2.0$	LSB
Analog input voltage	V <sub>AIN</sub>	ANI16 to ANI24		0		$AV_{REFP}$ and $EV_{DD0}$	V

**Note 1.** Excludes quantization error ( $\pm 1/2$  LSB).

**Note 2.** This value is indicated as a ratio (%FSR) to the full-scale value.

**Note 3.** When  $EV_{DD0} \leq AV_{REFP} \leq V_{DD}$ , the MAX. values are as follows.

Overall error: Add  $\pm 1.0$  LSB to the MAX. value when  $AV_{REFP} = V_{DD}$ .

Zero-scale error/Full-scale error: Add  $\pm 0.05\%$ FSR to the MAX. value when  $AV_{REFP} = V_{DD}$ .

Integral linearity error/ Differential linearity error: Add  $\pm 0.5$  LSB to the MAX. value when  $AV_{REFP} = V_{DD}$ .

**Note 4.** When  $AV_{REFP} < EV_{DD0} \leq V_{DD}$ , the MAX. values are as follows.

Overall error: Add  $\pm 4.0$  LSB to the MAX. value when  $AV_{REFP} = V_{DD}$ .

Zero-scale error/Full-scale error: Add  $\pm 0.20\%$ FSR to the MAX. value when  $AV_{REFP} = V_{DD}$ .

Integral linearity error/ Differential linearity error: Add  $\pm 2.0$  LSB to the MAX. value when  $AV_{REFP} = V_{DD}$ .

- (3) When reference voltage (+) = V<sub>DD</sub> (ADREFP1 = 0, ADREFP0 = 0), reference voltage (-) = V<sub>SS</sub> (ADREFM = 0), target pin: ANI0 to ANI7, ANI16 to ANI24, internal reference voltage, and temperature sensor output voltage

(TA = -40 to +105°C, 2.4 V ≤ EV<sub>DD0</sub> ≤ V<sub>DD</sub> ≤ 5.5 V, V<sub>SS</sub> = EV<sub>SS0</sub> = 0 V, Reference voltage (+) = V<sub>DD</sub>, Reference voltage (-) = V<sub>SS</sub>)

Parameter	Symbol	Conditions		MIN.	TYP.	MAX.	Unit	
Resolution	RES			8		10	bit	
Overall error Note 1	AINL	10-bit resolution	2.4 V ≤ V <sub>DD</sub> ≤ 5.5 V		1.2	±7.0	LSB	
Conversion time	t <sub>CONV</sub>	10-bit resolution Target pin: ANI0 to ANI14, ANI16 to ANI20	3.6 V ≤ V <sub>DD</sub> ≤ 5.5 V	2.125		39	μs	
			2.7 V ≤ V <sub>DD</sub> ≤ 5.5 V	3.1875		39	μs	
			2.4 V ≤ V <sub>DD</sub> ≤ 5.5 V	17		39	μs	
		10-bit resolution Target pin: internal reference voltage, and temperature sensor output voltage (HS (high-speed main) mode)	3.6 V ≤ V <sub>DD</sub> ≤ 5.5 V	2.375		39	μs	
			2.7 V ≤ V <sub>DD</sub> ≤ 5.5 V	3.5625		39	μs	
			2.4 V ≤ V <sub>DD</sub> ≤ 5.5 V	17		39	μs	
Zero-scale error Notes 1, 2	E <sub>ZS</sub>	10-bit resolution	2.4 V ≤ V <sub>DD</sub> ≤ 5.5 V			±0.60	%FSR	
Full-scale error Notes 1, 2	E <sub>FS</sub>	10-bit resolution	2.4 V ≤ V <sub>DD</sub> ≤ 5.5 V			±0.60	%FSR	
Integral linearity error Note 1	ILE	10-bit resolution	2.4 V ≤ V <sub>DD</sub> ≤ 5.5 V			±4.0	LSB	
Differential linearity error Note 1	DLE	10-bit resolution	2.4 V ≤ V <sub>DD</sub> ≤ 5.5 V			±2.0	LSB	
Analog input voltage	V <sub>AIN</sub>	ANI0 to ANI7		0		V <sub>DD</sub>	V	
		ANI16 to ANI24		0		EV <sub>DD0</sub>	V	
		Internal reference voltage (2.4 V ≤ V <sub>DD</sub> ≤ 5.5 V, HS (high-speed main) mode)		V <sub>BGR</sub> Note 3				V
		Temperature sensor output voltage (2.4 V ≤ V <sub>DD</sub> ≤ 5.5 V, HS (high-speed main) mode)		V <sub>TMPS25</sub> Note 3				V

**Note 1.** Excludes quantization error (±1/2 LSB).

**Note 2.** This value is indicated as a ratio (% FSR) to the full-scale value.

**Note 3.** Refer to 3.6.2 Temperature sensor characteristics/internal reference voltage characteristic.

(4) When reference voltage (+) = Internal reference voltage (ADREFP1 = 1, ADREFP0 = 0), reference voltage (-) = AVREFM/ANI1 (ADREFM = 1), target pin: ANI0, ANI2 to ANI7, ANI16 to ANI24

(TA = -40 to +105°C, 2.4 V ≤ VDD ≤ 5.5 V, 2.4 V ≤ EVDD0 ≤ VDD, VSS = EVSS0 = 0 V, Reference voltage (+) = VBGR Note 3, Reference voltage (-) = AVREFM = 0 V Note 4, HS (high-speed main) mode)

Parameter	Symbol	Conditions		MIN.	TYP.	MAX.	Unit
Resolution	RES			8			bit
Conversion time	tCONV	8-bit resolution	2.4 V ≤ VDD ≤ 5.5 V	17		39	μs
Zero-scale error Notes 1, 2	Ezs	8-bit resolution	2.4 V ≤ VDD ≤ 5.5 V			±0.60	% FSR
Integral linearity error Note 1	ILE	8-bit resolution	2.4 V ≤ VDD ≤ 5.5 V			±2.0	LSB
Differential linearity error Note 1	DLE	8-bit resolution	2.4 V ≤ VDD ≤ 5.5 V			±1.0	LSB
Analog input voltage	VAIN			0		VBGR Note 3	V

**Note 1.** Excludes quantization error (±1/2 LSB).

**Note 2.** This value is indicated as a ratio (% FSR) to the full-scale value.

**Note 3.** Refer to **3.6.2 Temperature sensor characteristics/internal reference voltage characteristic**.

**Note 4.** When reference voltage (-) = VSS, the MAX. values are as follows.

Zero-scale error: Add ±0.35%FSR to the MAX. value when reference voltage (-) = AVREFM.

Integral linearity error: Add ±0.5 LSB to the MAX. value when reference voltage (-) = AVREFM.

Differential linearity error: Add ±0.2 LSB to the MAX. value when reference voltage (-) = AVREFM.



### 3.6.2 Temperature sensor characteristics/internal reference voltage characteristic

(TA = -40 to +105°C, 2.4 V ≤ VDD ≤ 5.5 V, VSS = EVSS0 = 0 V, HS (high-speed main) mode)

Parameter	Symbol	Conditions	MIN.	TYP.	MAX.	Unit
Temperature sensor output voltage	VTMPS25	Setting ADS register = 80H, TA = +25°C		1.05		V
Internal reference voltage	VBGR	Setting ADS register = 81H	1.38	1.45	1.5	V
Temperature coefficient	FVTMPS	Temperature sensor that depends on the temperature		-3.6		mV/°C
Operation stabilization wait time	tAMP		5			μs

### 3.6.3 D/A converter characteristics

(TA = -40 to +105°C, 2.4 V ≤ EVSS0 ≤ VDD ≤ 5.5 V, VSS = EVSS0 = 0 V)

Parameter	Symbol	Conditions		MIN.	TYP.	MAX.	Unit
Resolution	RES					8	bit
Overall error	AINL	Rload = 4 MΩ	2.4 V ≤ VDD ≤ 5.5 V			±2.5	LSB
		Rload = 8 MΩ	2.4 V ≤ VDD ≤ 5.5 V			±2.5	LSB
Settling time	tSET	Cload = 20 pF	2.7 V ≤ VDD ≤ 5.5 V			3	μs
			2.4 V ≤ VDD < 2.7 V			6	μs

### 3.6.4 Comparator

(TA = -40 to +105°C, 2.7 V ≤ VDD ≤ 5.5 V, VSS = 0 V)

Parameter	Symbol	Conditions	MIN.	TYP.	MAX.	Unit
Input offset voltage	V <sub>IOCOMP</sub>			±5	±40	mV
Input voltage range	V <sub>ICMP</sub>		0		V <sub>DD</sub>	V
Internal reference voltage deviation	ΔV <sub>IREF</sub>	CmRVM register value : 7FH to 80H (m = 0, 1)			±2	LSB
		Other than above			±1	LSB
Response Time	t <sub>CR</sub> , t <sub>CF</sub>	Input amplitude±100mV		70	150	ns
Operation stabilization time <sup>Note 1</sup>	t <sub>CMP</sub>	CMPn = 0→1	V <sub>DD</sub> = 3.3 to 5.5 V		1	μs
			V <sub>DD</sub> = 2.7 to 3.3 V		3	μs
Reference voltage stabilization wait time	t <sub>VR</sub>	CVRE : 0→1 <sup>Note 2</sup>			20	μs
Operation current	I <sub>COMPDD</sub>	Separately, it is defined as the operation current of peripheral functions.				

**Note 1.** Time taken until the comparator satisfies the DC/AC characteristics after the comparator operation enable signal is switched (CMPnEN = 0 → 1).

**Note 2.** Enable comparator output (CnOE bit = 1; n = 0 to 1) after enabling operation of the internal reference voltage generator (by setting the CVREm bit to 1; m = 0 to 1) and waiting for the operation stabilization time to elapse.

### 3.6.5 PGA

(TA = -40 to +105°C, 2.7 V ≤ VDD ≤ 5.5 V, VSS = 0 V)

Parameter	Symbol	Conditions	MIN.	TYP.	MAX.	Unit
Input offset voltage	V <sub>IOPGA</sub>				±10	mV
Input voltage range	V <sub>IPGA</sub>		0		0.9 × V <sub>DD</sub> /Gain	V
Output voltage range	V <sub>IOHPGA</sub>		0.93 × V <sub>DD</sub>			V
	V <sub>IOLPGA</sub>				0.07 × V <sub>DD</sub>	V
Gain error		x4, x8			±1	%
		x16			±1.5	%
		x32			±2	%
Slew rate	SR <sub>RPGA</sub>	Rising When Vin = 0.1V <sub>DD</sub> /gain to 0.9V <sub>DD</sub> /gain. 10 to 90% of output voltage amplitude	4.0 V ≤ V <sub>DD</sub> ≤ 5.5 V (Other than x32)	3.5		V/μs
			4.0 V ≤ V <sub>DD</sub> ≤ 5.5 V (x32)	3.0		
			2.7 V ≤ V <sub>DD</sub> ≤ 4.0V	0.5		
	SR <sub>FPGA</sub>	Falling When Vin = 0.1V <sub>DD</sub> /gain to 0.9V <sub>DD</sub> /gain. 90 to 10% of output voltage amplitude	4.0 V ≤ V <sub>DD</sub> ≤ 5.5 V (Other than x32)	3.5		
			4.0 V ≤ V <sub>DD</sub> ≤ 5.5 V (x32)	3.0		
			2.7 V ≤ V <sub>DD</sub> ≤ 4.0V	0.5		
Reference voltage stabilization wait time- <sup>Note 1</sup>	t <sub>PGA</sub>	x4, x8			5	μs
		x16, x32			10	μs
Operation current	I <sub>PGADD</sub>	Separately, it is defined as the operation current of peripheral functions.				

**Note 1.** Time required until a state is entered where the DC and AC specifications of the PGA are satisfied after the PGA operation has been enabled (PGAEN = 1).

### 3.6.6 POR circuit characteristics

(TA = -40 to +105°C, VSS = 0 V)

Parameter	Symbol	Conditions	MIN.	TYP.	MAX.	Unit
Power on/down reset threshold	V <sub>POR</sub>	Voltage threshold on V <sub>DD</sub> rising	1.45	1.51	1.55	V
	V <sub>PDR</sub>	Voltage threshold on V <sub>DD</sub> falling <sup>Note 1</sup>	1.44	1.50	1.54	V
Minimum pulse width <sup>Note 2</sup>	T <sub>PW</sub>		300			μs

**Note 1.** However, when the operating voltage falls while the LVD is off, enter STOP mode, or enable the reset status using the external reset pin before the voltage falls below the operating voltage range shown in **3.4 AC Characteristics**.

**Note 2.** Minimum time required for a POR reset when V<sub>DD</sub> exceeds below V<sub>PDR</sub>. This is also the minimum time required for a POR reset from when V<sub>DD</sub> exceeds below 0.7 V to when V<sub>DD</sub> exceeds V<sub>POR</sub> while STOP mode is entered or the main system clock is stopped through setting bit 0 (HIOS<sub>TOP</sub>) and bit 7 (MSTOP) in the clock operation status control register (CSC).

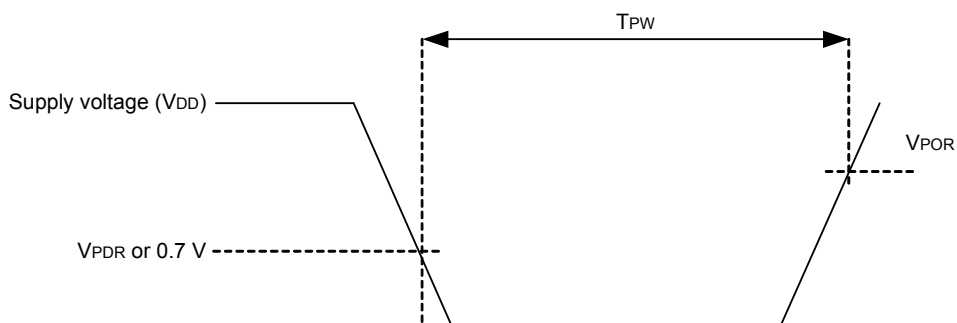

### 3.6.7 LVD circuit characteristics

#### (1) Reset Mode and Interrupt Mode

(TA = -40 to +105°C, VPDR ≤ VDD ≤ 5.5 V, VSS = 0 V)

Parameter		Symbol	Conditions	MIN.	TYP.	MAX.	Unit		
Voltage detection threshold	Supply voltage level	VLVD0	Rising edge	3.90	4.06	4.22	V		
			Falling edge	3.83	3.98	4.13	V		
		VLVD1	Rising edge	3.60	3.75	3.90	V		
			Falling edge	3.53	3.67	3.81	V		
		VLVD2	Rising edge	3.01	3.13	3.25	V		
			Falling edge	2.94	3.06	3.18	V		
		VLVD3	Rising edge	2.90	3.02	3.14	V		
			Falling edge	2.85	2.96	3.07	V		
		VLVD4	Rising edge	2.81	2.92	3.03	V		
			Falling edge	2.75	2.86	2.97	V		
		VLVD5	Rising edge	2.70	2.81	2.92	V		
			Falling edge	2.64	2.75	2.86	V		
		VLVD6	Rising edge	2.61	2.71	2.81	V		
			Falling edge	2.55	2.65	2.75	V		
		VLVD7	Rising edge	2.51	2.61	2.71	V		
			Falling edge	2.45	2.55	2.65	V		
		Minimum pulse width		tlw		300			μs
		Detection delay time						300	μs

**(2) Interrupt & Reset Mode**

(TA = -40 to +105°C, VPDR ≤ VDD ≤ 5.5 V, VSS = 0 V)

Parameter	Symbol	Conditions	MIN.	TYP.	MAX.	Unit	
Voltage detection threshold	VLVDD0	VPOC2, VPOC1, VPOC0 = 0, 1, 1, falling reset voltage	2.64	2.75	2.86	V	
	VLVDD1	LVIS1, LVIS0 = 1, 0	Rising release reset voltage	2.81	2.92	3.03	V
			Falling interrupt voltage	2.75	2.86	2.97	V
	VLVDD2	LVIS1, LVIS0 = 0, 1	Rising release reset voltage	2.90	3.02	3.14	V
			Falling interrupt voltage	2.85	2.96	3.07	V
	VLVDD3	LVIS1, LVIS0 = 0, 0	Rising release reset voltage	3.90	4.06	4.22	V
Falling interrupt voltage			3.83	3.98	4.13	V	

**3.6.8 Power supply voltage rising slope characteristics**

(TA = -40 to +105°C, VSS = 0 V)

Parameter	Symbol	Conditions	MIN.	TYP.	MAX.	Unit
Power supply voltage rising slope	SVDD				54	V/ms

**Caution** Make sure to keep the internal reset state by the LVD circuit or an external reset until VDD reaches the operating voltage range shown in 3.4 AC Characteristics.

**3.7 RAM Data Retention Characteristics**

(TA = -40 to +105°C, VSS = 0V)

Parameter	Symbol	Conditions	MIN.	TYP.	MAX.	Unit
Data retention supply voltage	VDDDR		1.44 Notes 1, 2		5.5	V

**Note 1.** The value depends on the POR detection voltage. When the voltage drops, the RAM data is retained before a POR reset is effected, but RAM data is not retained when a POR reset is effected.

**Note 2.** Enter STOP mode before the supply voltage falls below the recommended operating voltage.

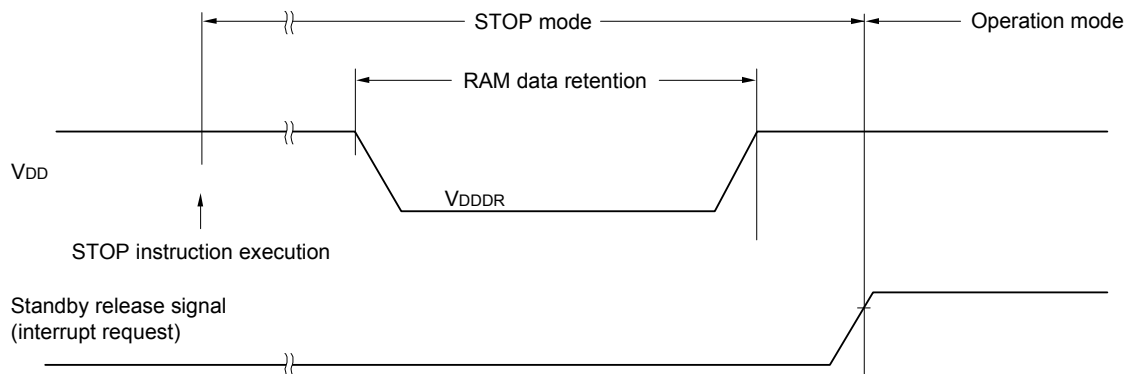

**3.8 Flash Memory Programming Characteristics**

(TA = -40 to +105°C, 2.4 V ≤ VDD ≤ 5.5 V, VSS = 0 V)

Parameter	Symbol	Conditions	MIN.	TYP.	MAX.	Unit
System clock frequency	fCLK	2.4 V ≤ VDD ≤ 5.5 V	1		32	MHz

(TA = -40 to +105°C, 2.4 V ≤ VDD ≤ 5.5 V, VSS = 0 V)

Parameter	Symbol	Conditions		MIN.	TYP.	MAX.	Unit
Number of code flash rewrites Notes 1, 2, 3	Cenwr	Retained for 20 years	TA = 85°C	1,000			Times
Number of data flash rewrites Notes 1, 2, 3		Retained for 1 year	TA = 25°C		1,000,000		
		Retained for 5 years	TA = 85°C	100,000			
		Retained for 20 years	TA = 85°C	10,000			

**Note 1.** 1 erase + 1 write after the erase is regarded as 1 rewrite. The retaining years are until next rewrite after the rewrite.

**Note 2.** When using flash memory programmer and Renesas Electronics self-programming library

**Note 3.** These are the characteristics of the flash memory and the results obtained from reliability testing by Renesas Electronics Corporation.

### 3.9 Dedicated Flash Memory Programmer Communication (UART)

(TA = -40 to +105°C, 2.4 V ≤ EVDD0 ≤ VDD ≤ 5.5 V, VSS = EVSS0 = 0 V)

Parameter	Symbol	Conditions	MIN.	TYP.	MAX.	Unit
Transfer rate		During serial programming	115,200		1,000,000	bps

### 3.10 Timing of Entry to Flash Memory Programming Modes

(TA = -40 to +105°C, 2.4 V ≤ EVDD0 ≤ VDD ≤ 5.5 V, VSS = EVSS0 = 0 V)

Parameter	Symbol	Conditions	MIN.	TYP.	MAX.	Unit
How long from when an external reset ends until the initial communication settings are specified	tsuINIT	POR and LVD reset must end before the external reset ends.			100	ms
How long from when the TOOL0 pin is placed at the low level until an external reset ends	tsu	POR and LVD reset must end before the external reset ends.	10			μs
How long the TOOL0 pin must be kept at the low level after an external reset ends (excluding the processing time of the firmware to control the flash memory)	tHD	POR and LVD reset must end before the external reset ends.	1			ms

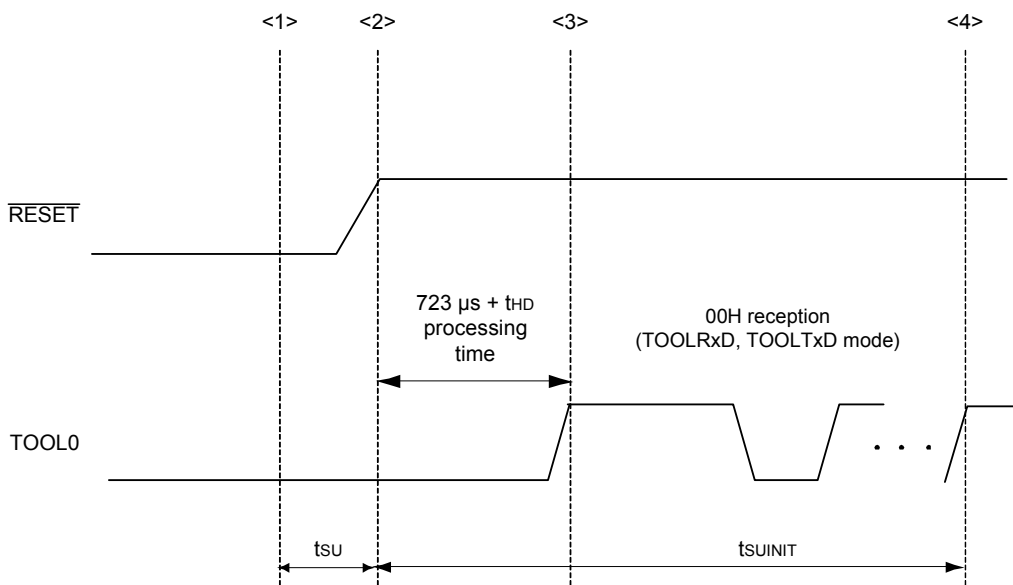

- <1> The low level is input to the TOOL0 pin.
- <2> The external reset ends (POR and LVD reset must end before the external reset ends).
- <3> The TOOL0 pin is set to the high level.
- <4> Setting of the flash memory programming mode by UART reception and complete the baud rate setting.

**Remark** tsuINIT: The segment shows that it is necessary to finish specifying the initial communication settings within 100 ms from when the external resets end.  
 tsu: How long from when the TOOL0 pin is placed at the low level until a pin reset ends  
 tHD: How long to keep the TOOL0 pin at the low level from when the external resets end (excluding the processing time of the firmware to control the flash memory)

## 4. PACKAGE DRAWINGS

### 4.1 24-pin products

R5F11B7CANA, R5F11B7EANA, R5F11B7CGNA, R5F11B7EGNA

JEITA Package Code	RENESAS Code	Previous Code	MASS (TYP.) [g]
P-HWQFN24-4x4-0.50	PWQN0024KE-A	P24K8-50-CAB-1	0.04

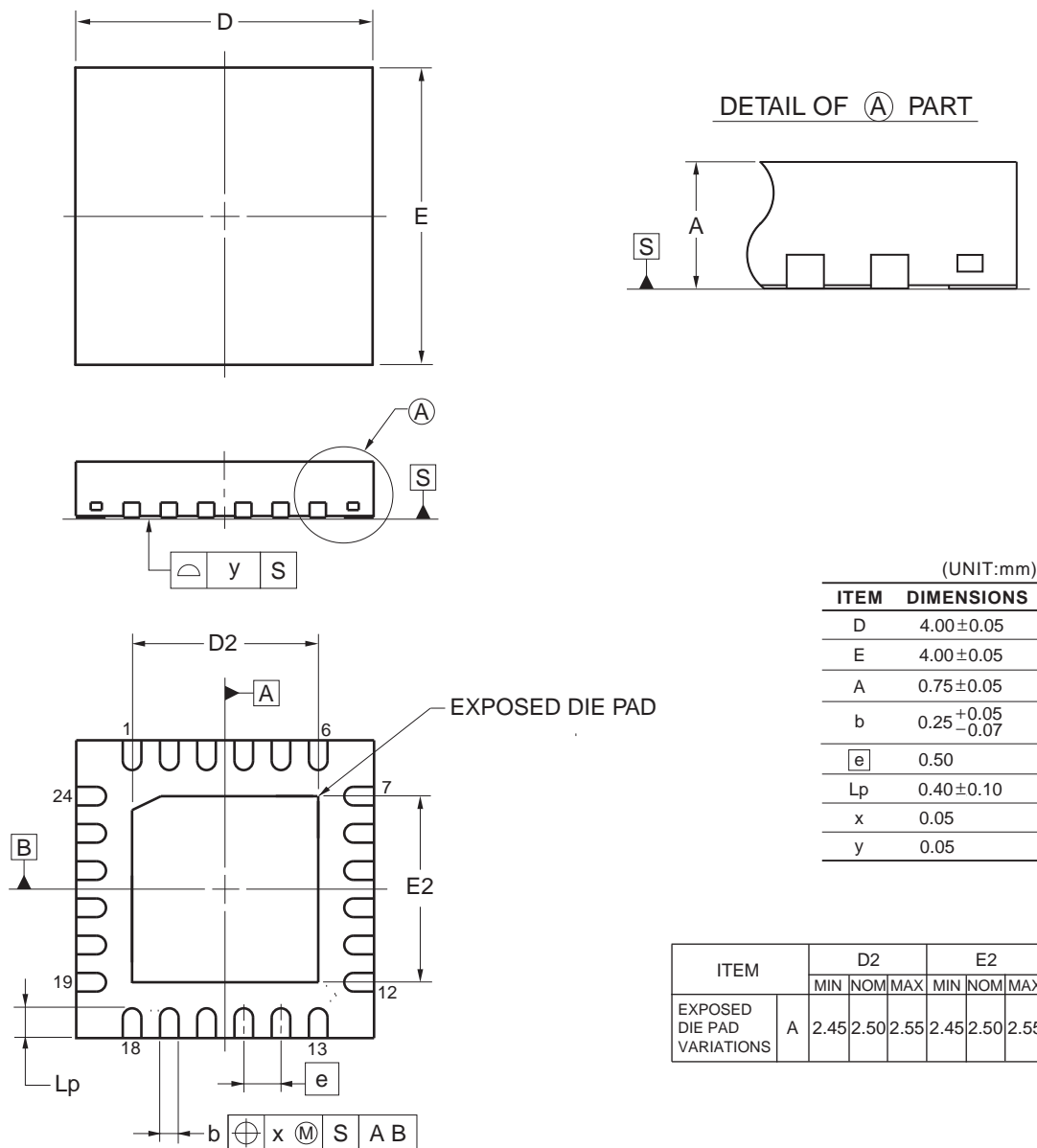

©2012 Renesas Electronics Corporation. All rights reserved.



### 4.2 32-pin products

R5F11BBCAFP, R5F11BBEAFP, R5F11BBCGFP, R5F11BBEGFP

JEITA Package Code	RENESAS Code	Previous Code	MASS (TYP.) [g]
P-LQFP32-7x7-0.80	PLQP0032GB-A	P32GA-80-GBT-1	0.2

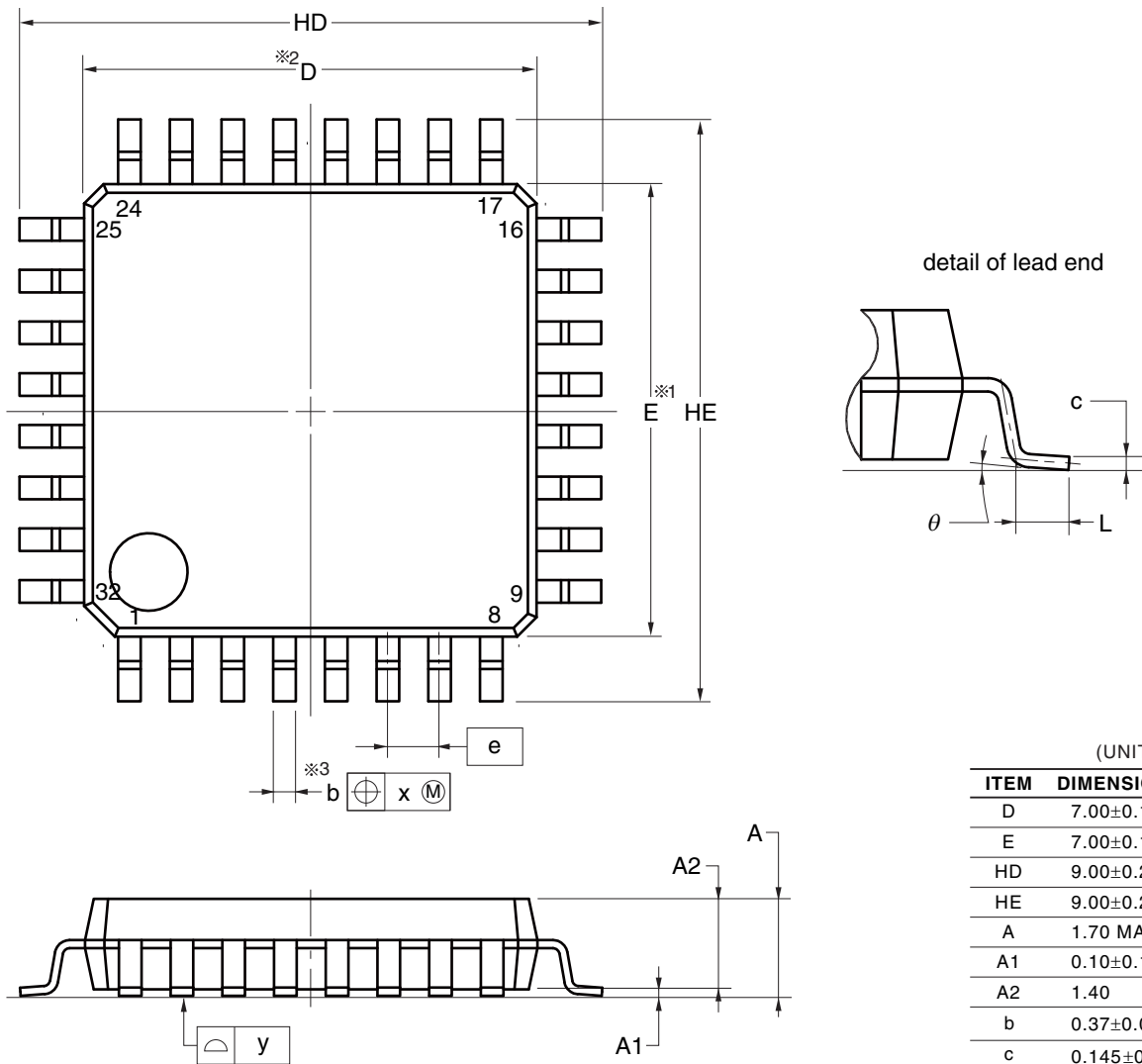

**NOTE**

1. Dimensions "※1" and "※2" do not include mold flash.
2. Dimension "※3" does not include trim offset.

© 2012 Renesas Electronics Corporation. All rights reserved.

### 4.3 36-pin products

R5F11BCCALA, R5F11BCEALA, R5F11BCCGLA, R5F11BCEGLA

JEITA Package Code	RENESAS Code	Previous Code	MASS (TYP.) [g]
P-WFLGA36-4x4-0.50	PWLG0036KA-A	P36FC-50-AA4-2	0.023

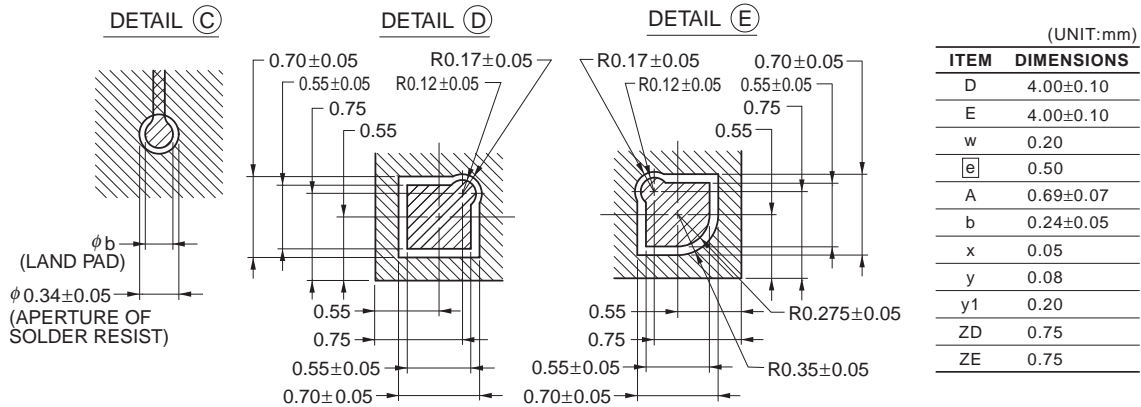
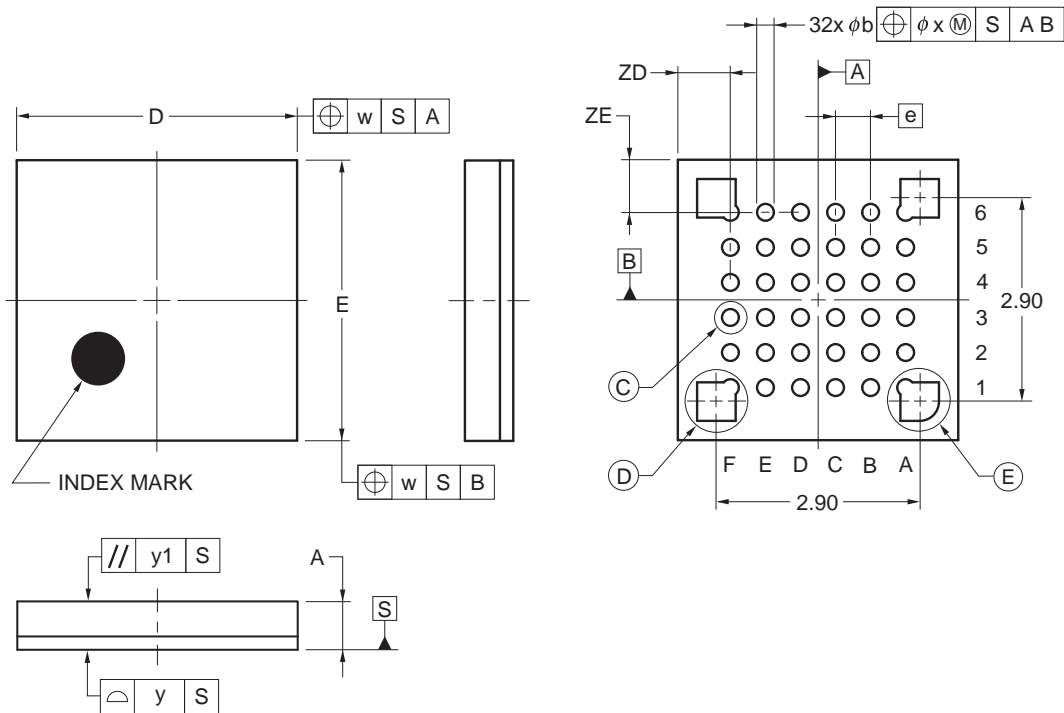

©2012 Renesas Electronics Corporation. All rights reserved.

### 4.4 48-pin products

R5F11BGCAFB, R5F11BGEAFB, R5F11BGCGFB, R5F11BGEGFB

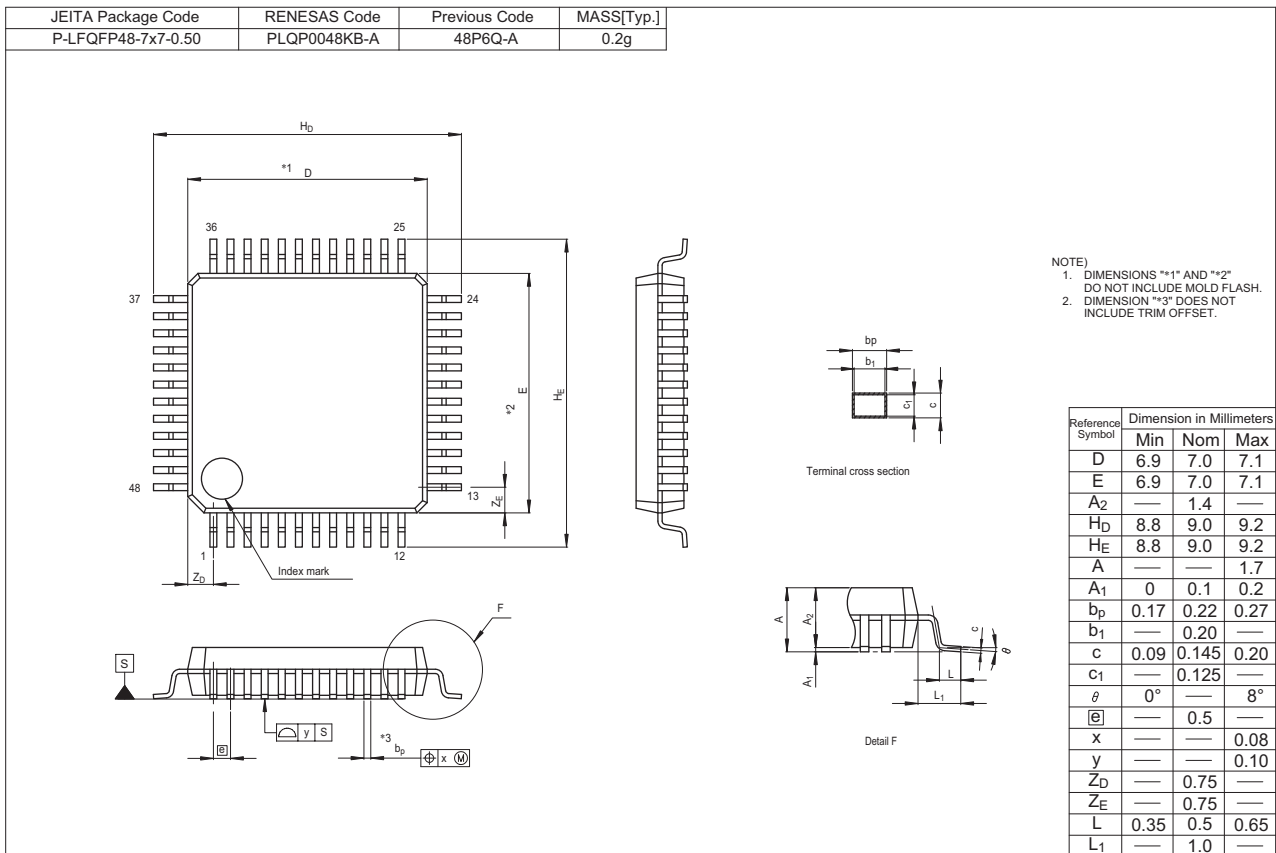

### 4.5 64-pin products

R5F11BLCAFB, R5F11BLEAFB, R5F11BLCGFB, R5F11BLEGFB

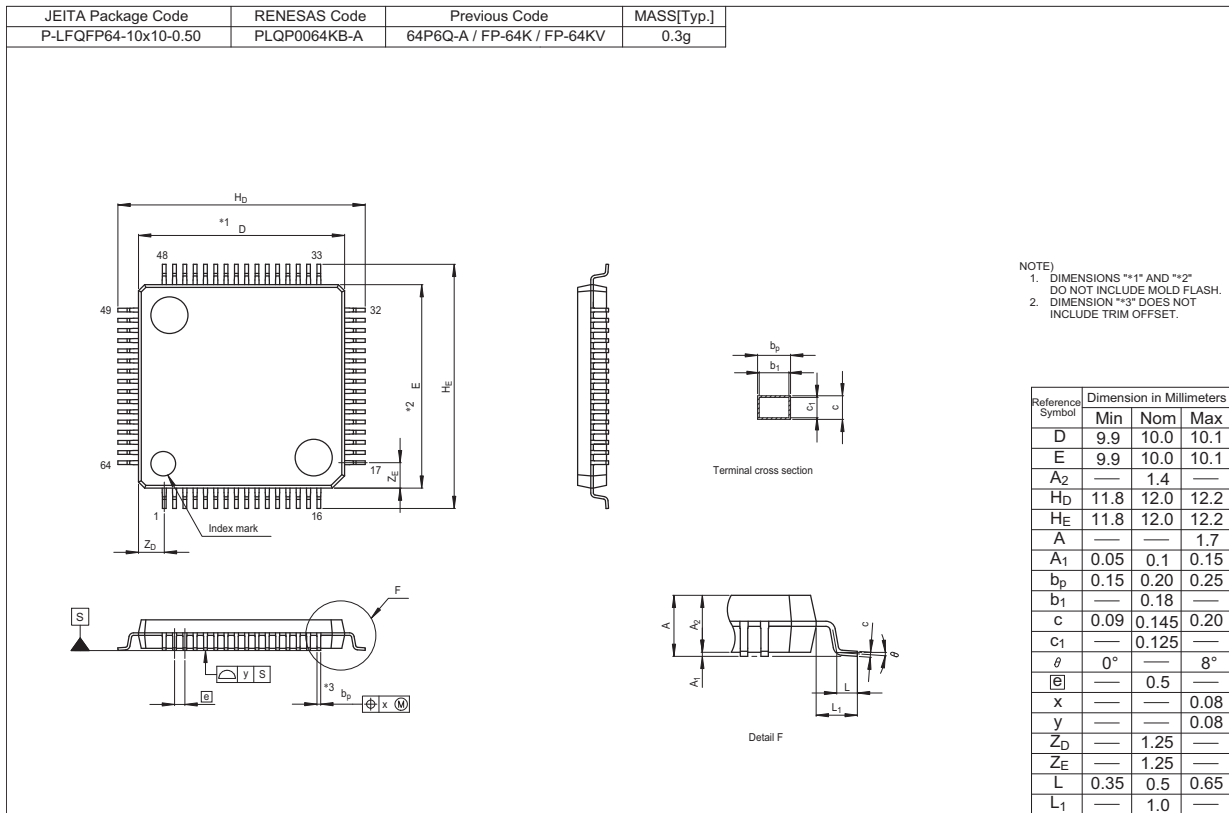

REVISION HISTORY	RL78/G1F Datasheet
------------------	--------------------

Rev.	Date	Description	
		Page	Summary
0.10		—	First Edition issued
0.50	Jan 14, 2015	3	Modification of description in Figure 1 - 1 Part Number, Memory Size, and Package of RL78/G1F
		10	Addition of description in 1.4 Pin Identification
		11	Modification of description in 1.5 Block Diagram
		12, 13	Modification of description in 1.6 Outline of Functions
		14	Addition of target products to the beginning
		17	Modification of 2.2.2 On-chip oscillator characteristics
		18	Addition of note 4 in 2.3.1 Pin characteristics
		23, 25, 27	Modification of 2.3.2 Supply current characteristics
		73	Modification of 2.6.4 Comparator
		73	Modification of 2.6.5 PGA
		77	Renamed to 2.7 RAM Data Retention Characteristics
		79	Addition of target products to the beginning
		83	Modification of 3.2.2 On-chip oscillator characteristics
		87	Modification of "Output voltage, low"
		89, 91, 93	Modification of 3.3.2 Supply current characteristics
		130	Modification of 3.6.4 Comparator
130	Modification of 3.6.5 PGA		
133	Renamed to 3.7 RAM Data Retention Characteristics		
1.00	Jan 14, 2015	All	Modification of the unit symbol (PWMOP into PWMOPA)
		1	Modification of descriptions in 1.1 Features
		10	Modification of 1.4 Pin Identification
		13	Modification of 1.6 Outline of Functions
		73	Modification of 2.6.5 PGA
		130	Modification of 3.6.5 PGA
1.10	Aug 12, 2016	5	Addition of product name (RL78/G1F) and description (Top View) in 1.3.1 24-pin products
		6	Addition of product name (RL78/G1F) and description (Top View) in 1.3.2 32-pin products
		8	Addition of product name (RL78/G1F) and description (Top View) in 1.3.4 48-pin products
		9	Addition of product name (RL78/G1F) and description (Top View) in 1.3.5 64-pin products

SuperFlash is a registered trademark of Silicon Storage Technology, Inc. in several countries including the United States and Japan.

Caution: This product uses SuperFlash® technology licensed from Silicon Storage Technology, Inc.

All trademarks and registered trademarks are the property of their respective owners.

## NOTES FOR CMOS DEVICES

- (1) **VOLTAGE APPLICATION WAVEFORM AT INPUT PIN:** Waveform distortion due to input noise or a reflected wave may cause malfunction. If the input of the CMOS device stays in the area between  $V_{IL}$  (MAX) and  $V_{IH}$  (MIN) due to noise, etc., the device may malfunction. Take care to prevent chattering noise from entering the device when the input level is fixed, and also in the transition period when the input level passes through the area between  $V_{IL}$  (MAX) and  $V_{IH}$  (MIN).
- (2) **HANDLING OF UNUSED INPUT PINS:** Unconnected CMOS device inputs can be cause of malfunction. If an input pin is unconnected, it is possible that an internal input level may be generated due to noise, etc., causing malfunction. CMOS devices behave differently than Bipolar or NMOS devices. Input levels of CMOS devices must be fixed high or low by using pull-up or pull-down circuitry. Each unused pin should be connected to VDD or GND via a resistor if there is a possibility that it will be an output pin. All handling related to unused pins must be judged separately for each device and according to related specifications governing the device.
- (3) **PRECAUTION AGAINST ESD:** A strong electric field, when exposed to a MOS device, can cause destruction of the gate oxide and ultimately degrade the device operation. Steps must be taken to stop generation of static electricity as much as possible, and quickly dissipate it when it has occurred. Environmental control must be adequate. When it is dry, a humidifier should be used. It is recommended to avoid using insulators that easily build up static electricity. Semiconductor devices must be stored and transported in an anti-static container, static shielding bag or conductive material. All test and measurement tools including work benches and floors should be grounded. The operator should be grounded using a wrist strap. Semiconductor devices must not be touched with bare hands. Similar precautions need to be taken for PW boards with mounted semiconductor devices.
- (4) **STATUS BEFORE INITIALIZATION:** Power-on does not necessarily define the initial status of a MOS device. Immediately after the power source is turned ON, devices with reset functions have not yet been initialized. Hence, power-on does not guarantee output pin levels, I/O settings or contents of registers. A device is not initialized until the reset signal is received. A reset operation must be executed immediately after power-on for devices with reset functions.
- (5) **POWER ON/OFF SEQUENCE:** In the case of a device that uses different power supplies for the internal operation and external interface, as a rule, switch on the external power supply after switching on the internal power supply. When switching the power supply off, as a rule, switch off the external power supply and then the internal power supply. Use of the reverse power on/off sequences may result in the application of an overvoltage to the internal elements of the device, causing malfunction and degradation of internal elements due to the passage of an abnormal current. The correct power on/off sequence must be judged separately for each device and according to related specifications governing the device.
- (6) **INPUT OF SIGNAL DURING POWER OFF STATE :** Do not input signals or an I/O pull-up power supply while the device is not powered. The current injection that results from input of such a signal or I/O pull-up power supply may cause malfunction and the abnormal current that passes in the device at this time may cause degradation of internal elements. Input of signals during the power off state must be judged separately for each device and according to related specifications governing the device.

## Notice

1. Descriptions of circuits, software and other related information in this document are provided only to illustrate the operation of semiconductor products and application examples. You are fully responsible for the incorporation of these circuits, software, and information in the design of your equipment. Renesas Electronics assumes no responsibility for any losses incurred by you or third parties arising from the use of these circuits, software, or information.
2. Renesas Electronics has used reasonable care in preparing the information included in this document, but Renesas Electronics does not warrant that such information is error free. Renesas Electronics assumes no liability whatsoever for any damages incurred by you resulting from errors in or omissions from the information included herein.
3. Renesas Electronics does not assume any liability for infringement of patents, copyrights, or other intellectual property rights of third parties by or arising from the use of Renesas Electronics products or technical information described in this document. No license, express, implied or otherwise, is granted hereby under any patents, copyrights or other intellectual property rights of Renesas Electronics or others.
4. You should not alter, modify, copy, or otherwise misappropriate any Renesas Electronics product, whether in whole or in part. Renesas Electronics assumes no responsibility for any losses incurred by you or third parties arising from such alteration, modification, copy or otherwise misappropriation of Renesas Electronics product.
5. Renesas Electronics products are classified according to the following two quality grades: "Standard" and "High Quality". The recommended applications for each Renesas Electronics product depends on the product's quality grade, as indicated below.  
"Standard": Computers; office equipment; communications equipment; test and measurement equipment; audio and visual equipment; home electronic appliances; machine tools; personal electronic equipment; and industrial robots etc.  
"High Quality": Transportation equipment (automobiles, trains, ships, etc.); traffic control systems; anti-disaster systems; anti-crime systems; and safety equipment etc.  
Renesas Electronics products are neither intended nor authorized for use in products or systems that may pose a direct threat to human life or bodily injury (artificial life support devices or systems, surgical implantations etc.), or may cause serious property damages (nuclear reactor control systems, military equipment etc.). You must check the quality grade of each Renesas Electronics product before using it in a particular application. You may not use any Renesas Electronics product for any application for which it is not intended. Renesas Electronics shall not be in any way liable for any damages or losses incurred by you or third parties arising from the use of any Renesas Electronics product for which the product is not intended by Renesas Electronics.
6. You should use the Renesas Electronics products described in this document within the range specified by Renesas Electronics, especially with respect to the maximum rating, operating supply voltage range, movement power voltage range, heat radiation characteristics, installation and other product characteristics. Renesas Electronics shall have no liability for malfunctions or damages arising out of the use of Renesas Electronics products beyond such specified ranges.
7. Although Renesas Electronics endeavors to improve the quality and reliability of its products, semiconductor products have specific characteristics such as the occurrence of failure at a certain rate and malfunctions under certain use conditions. Further, Renesas Electronics products are not subject to radiation resistance design. Please be sure to implement safety measures to guard them against the possibility of physical injury, and injury or damage caused by fire in the event of the failure of a Renesas Electronics product, such as safety design for hardware and software including but not limited to redundancy, fire control and malfunction prevention, appropriate treatment for aging degradation or any other appropriate measures. Because the evaluation of microcomputer software alone is very difficult, please evaluate the safety of the final products or systems manufactured by you.
8. Please contact a Renesas Electronics sales office for details as to environmental matters such as the environmental compatibility of each Renesas Electronics product. Please use Renesas Electronics products in compliance with all applicable laws and regulations that regulate the inclusion or use of controlled substances, including without limitation, the EU RoHS Directive. Renesas Electronics assumes no liability for damages or losses occurring as a result of your noncompliance with applicable laws and regulations.
9. Renesas Electronics products and technology may not be used for or incorporated into any products or systems whose manufacture, use, or sale is prohibited under any applicable domestic or foreign laws or regulations. You should not use Renesas Electronics products or technology described in this document for any purpose relating to military applications or use by the military, including but not limited to the development of weapons of mass destruction. When exporting the Renesas Electronics products or technology described in this document, you should comply with the applicable export control laws and regulations and follow the procedures required by such laws and regulations.
10. It is the responsibility of the buyer or distributor of Renesas Electronics products, who distributes, disposes of, or otherwise places the product with a third party, to notify such third party in advance of the contents and conditions set forth in this document, Renesas Electronics assumes no responsibility for any losses incurred by you or third parties as a result of unauthorized use of Renesas Electronics products.
11. This document may not be reproduced or duplicated in any form, in whole or in part, without prior written consent of Renesas Electronics.
12. Please contact a Renesas Electronics sales office if you have any questions regarding the information contained in this document or Renesas Electronics products, or if you have any other inquiries.

(Note 1) "Renesas Electronics" as used in this document means Renesas Electronics Corporation and also includes its majority-owned subsidiaries.

(Note 2) "Renesas Electronics product(s)" means any product developed or manufactured by or for Renesas Electronics.



### SALES OFFICES

Renesas Electronics Corporation

<http://www.renesas.com>

Refer to "<http://www.renesas.com/>" for the latest and detailed information.

#### Renesas Electronics America Inc.

2801 Scott Boulevard Santa Clara, CA 95050-2549, U.S.A.  
Tel: +1-408-588-6000, Fax: +1-408-588-6130

#### Renesas Electronics Canada Limited

9251 Yonge Street, Suite 8309 Richmond Hill, Ontario Canada L4C 9T3  
Tel: +1-905-237-2004

#### Renesas Electronics Europe Limited

Dukes Meadow, Millboard Road, Bourne End, Buckinghamshire, SL8 5FH, U.K.  
Tel: +44-1628-585-100, Fax: +44-1628-585-900

#### Renesas Electronics Europe GmbH

Arcadiastrasse 10, 40472 Düsseldorf, Germany  
Tel: +49-211-6503-0, Fax: +49-211-6503-1327

#### Renesas Electronics (China) Co., Ltd.

Room 1709, Quantum Plaza, No.27 ZhiChunLu Haidian District, Beijing 100191, P.R.China  
Tel: +86-10-8235-1155, Fax: +86-10-8235-7679

#### Renesas Electronics (Shanghai) Co., Ltd.

Unit 301, Tower A, Central Towers, 555 Langao Road, Putuo District, Shanghai, P. R. China 200333  
Tel: +86-21-2226-0888, Fax: +86-21-2226-0999

#### Renesas Electronics Hong Kong Limited

Unit 1601-1611, 16/F., Tower 2, Grand Century Place, 193 Prince Edward Road West, Mongkok, Kowloon, Hong Kong  
Tel: +852-2265-6688, Fax: +852 2886-9022

#### Renesas Electronics Taiwan Co., Ltd.

13F, No. 363, Fu Shing North Road, Taipei 10543, Taiwan  
Tel: +886-2-8175-9600, Fax: +886 2-8175-9670

#### Renesas Electronics Singapore Pte. Ltd.

80 Bendemeer Road, Unit #06-02 Hyflux Innovation Centre, Singapore 339949  
Tel: +65-6213-0200, Fax: +65-6213-0300

#### Renesas Electronics Malaysia Sdn.Bhd.

Unit 1207, Block B, Menara Amcorp, Amcorp Trade Centre, No. 18, Jln Persiaran Barat, 46050 Petaling Jaya, Selangor Darul Ehsan, Malaysia  
Tel: +60-3-7955-9390, Fax: +60-3-7955-9510

#### Renesas Electronics India Pvt. Ltd.

No.77C, 100 Feet Road, HAL II Stage, Indiranagar, Bangalore, India  
Tel: +91-80-67208700, Fax: +91-80-67208777

#### Renesas Electronics Korea Co., Ltd.

12F., 234 Teheran-ro, Gangnam-Gu, Seoul, 135-080, Korea  
Tel: +82-2-558-3737, Fax: +82-2-558-5141

# Mouser Electronics

Authorized Distributor

Click to View Pricing, Inventory, Delivery & Lifecycle Information:

## Renesas Electronics:

[R5F11BLCAFB#30](#) [R5F11BCCALA#U0](#) [R5F11BCEALA#U0](#) [R5F11B7EANA#U0](#) [R5F11B7CANA#U0](#)  
[R5F11BBCAFP#30](#) [R5F11BGEAFB#50](#) [R5F11BBCAFP#50](#) [R5F11BLEAFB#30](#) [R5F11BGCAFB#30](#)  
[R5F11BBEAFP#30](#) [R5F11BGEAFB#30](#) [R5F11BGCAFB#50](#) [R5F11B7CANA#W0](#) [R5F11B7CGNA#U0](#)  
[R5F11B7CGNA#W0](#) [R5F11B7EANA#W0](#) [R5F11B7EGNA#U0](#) [R5F11B7EGNA#W0](#) [R5F11BLEAFB#50](#)  
[R5F11BLEGFB#30](#) [R5F11BLEGFB#50](#) [R5F11BGCGFB#50](#) [R5F11BGEGFB#30](#) [R5F11BGEGFB#50](#)  
[R5F11BLCAFB#50](#) [R5F11BLCGFB#30](#) [R5F11BLCGFB#50](#) [R5F11BCCGLA#U0](#) [R5F11BCCGLA#W0](#)  
[R5F11BCEALA#W0](#) [R5F11BCEGLA#U0](#) [R5F11BCEGLA#W0](#) [R5F11BGCGFB#30](#) [R5F11BBCGFP#30](#)  
[R5F11BBCGFP#50](#) [R5F11BBEAFP#50](#) [R5F11BBEGFP#30](#) [R5F11BBEGFP#50](#) [R5F11BCCALA#W0](#)





**Стандарт  
Электрон  
Связь**

Мы молодая и активно развивающаяся компания в области поставок электронных компонентов. Мы поставляем электронные компоненты отечественного и импортного производства напрямую от производителей и с крупнейших складов мира.

Благодаря сотрудничеству с мировыми поставщиками мы осуществляем комплексные и плановые поставки широчайшего спектра электронных компонентов.

Собственная эффективная логистика и склад в обеспечивает надежную поставку продукции в точно указанные сроки по всей России.

Мы осуществляем техническую поддержку нашим клиентам и предпродажную проверку качества продукции. На все поставляемые продукты мы предоставляем гарантию .

Осуществляем поставки продукции под контролем ВП МО РФ на предприятия военно-промышленного комплекса России , а также работаем в рамках 275 ФЗ с открытием отдельных счетов в уполномоченном банке. Система менеджмента качества компании соответствует требованиям ГОСТ ISO 9001.

Минимальные сроки поставки, гибкие цены, неограниченный ассортимент и индивидуальный подход к клиентам являются основой для выстраивания долгосрочного и эффективного сотрудничества с предприятиями радиоэлектронной промышленности, предприятиями ВПК и научно-исследовательскими институтами России.

С нами вы становитесь еще успешнее!

**Наши контакты:**

**Телефон:** +7 812 627 14 35

**Электронная почта:** [sales@st-electron.ru](mailto:sales@st-electron.ru)

**Адрес:** 198099, Санкт-Петербург,  
Промышленная ул, дом № 19, литера Н,  
помещение 100-Н Офис 331