



## Highly Integrated and Performance Optimized 32-bit Microcontrollers for Automotive and Industrial Applications







## Contents

TriCore™ Family Concept	04
TriCore™ Based Product Roadmap	06
PRO-SIL™ Safety Concept	07
TriCore™ for Powertrain Applications	08
TriCore™ for Safety Applications	18
TriCore™ for Body Applications	28
TriCore™ for Industrial Applications	30
AUDO Family System Architecture	36
AURIX™ Family System Architecture	44
Embedded Software (AUTOSAR etc.)	48
Development Support	52
Tool Partners	54





## Evolution of TriCore™ Generations

In 1999, Infineon launched the first generation of AUDO (AUtomotive unified processOR) family. Based on a unified RISC/MCU/DSP processor core, this 32-bit TriCore™ microcontroller was a computational power horse. And the company has evolved and optimized the concept ever since – culminating in what is now the fourth TriCore™ generation. Based on the TriCore™ architecture, the new AUDO MAX family (version 1.6) sets a new performance standard for automotive microcontrollers. The TriCore™ success story is continuing with the introduction of the AURIX™ multicore family. AURIX™ combines easy-to-use functional safety support, strong increase in performance and a future-proven security solution in a highly scalable product family.



Infineon's AUDO families are designed to handle highly complex algorithms. They are the perfect match for gasoline and diesel engine management systems – meeting rising market demands for lower emissions and higher efficiency levels. These trends are being accelerated by the Euro 5 and Euro 6 standards and increasingly stringent CO<sub>2</sub> regulations. In addition to engine management, the AUDO family is also ideal for applications in hybrid and electric vehicles as well as for transmission, active and passive safety and chassis applications. TriCore™-based products also deliver the versatility required for the industrial sector, excelling in optimized motor control applications and signal processing.

Infineon's broad product portfolio allows engineers to choose from a wide range of memories, peripheral sets, frequencies, temperatures and packaging options. All of these features are fully compatible across generations. The new core is platform-compatible and can be used with software developed on existing controllers. Safety software is also available to help manufacturers meet SIL/ASIL safety standards. All members of the AUDO family are binary-compatible and share the same development tools. An AUTOSAR library that enables existing code ready for integration is also available.





## Family Highlights

- Compatibility and scalability
- Lowest system cost
- Industry benchmark system performance
- Easy to use
- Broad portfolio
- Certified to automotive standards

## Applications

### Powertrain



- Gasoline Direct Injection
- Gasoline Multi-Port Injection
- Diesel Direct Injection
- Automatic Transmission – Hydraulic Control
- Dry Double Clutch Transmission – Hydraulic Control
- Dry Double Clutch Transmission – Electrical Control
- Integrated (H)EV Control
- (H)EV Battery Management System

### Safety



- Chassis Domain Control
- Electric Power Steering (EPS)
- Active Suspension Control System
- Advanced Airbag System
- Braking ECU
- Multi-purpose Camera Configuration
- Short Range RADAR (24GHz) System
- Long Range RADAR (76/77GHz) System

### Body



- Body Domain Controller
- Gateway
- Advanced Body Applications

### Industrial & Multimarket



- Mobile Controller
- Inverter
- Wind Turbine Inverter
- Solar Panel

# TriCore™ Based Product Roadmap

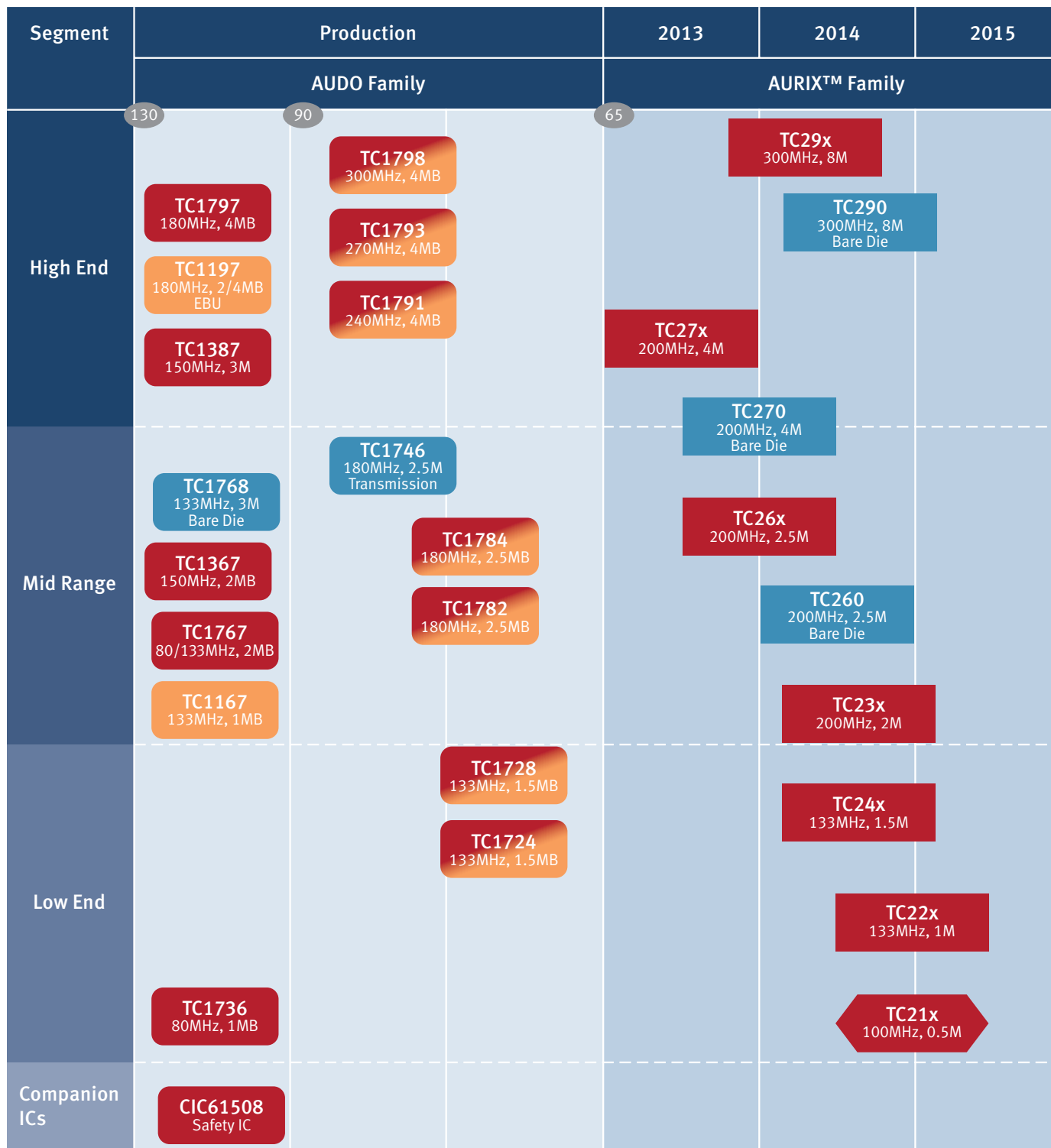

- Engine, Safety & Chassis Body
- Transmission
- Industrial & Multimarket
- Production
- Development
- Concept
- XX Technology

# PRO-SIL™

## Infineon's PRO-SIL™ Program, Designed to Protect

The functional complexity and levels of integration of real-time safety-critical applications continue to increase exponentially. In addition, the product life cycle of these applications has to meet stringent safety standards. Norms such as IEC 61508 and ISO 26262 mandate more robust and comprehensive product development processes and functional safety concepts in automotive and industrial applications.

Infineon's PRO-SIL™ safety program is designed to ease and speed up your automotive and industrial design to comply with such standards. Across the full certification spectrum from Safety Integrity Levels (SIL) 1 to 4 and Automotive Safety Integrity Levels (ASIL) A to D, our end-to-end PRO-SIL™ approach will help you select the right hardware, software and functional safety concepts to meet your design and compliance needs.

### PRO-SIL™ Highlights

- Broad hardware portfolio from sensors to microcontrollers, along with analog and power management ICs providing SIL-supporting features.
- For ISO 26262 PRO-SIL™ products, safety concepts are in place to enable the required safety measures, testing, monitoring and diagnostics capabilities for your safety architecture.
- Comprehensive safety software packages for seamless integration are in place, such as the SafeTlib software for Infineon's AURIX™ microcontroller family
- Full range of support services – from consulting and design advice, including training, documentation and technical support – can be provided.
- Safety-focused organization and project management based on Infineon's Zero Defect Program, Safety Culture and Quality Management System are in place.

Infineon's PRO-SIL™ logo guides you to our products (HW, SW, Safety Documentation) with SIL-supporting features. These products will simplify the implementation of customers' system design and improve time-to-market in achieving the desired functional safety level compliance.

### PRO-SIL™ Benefits

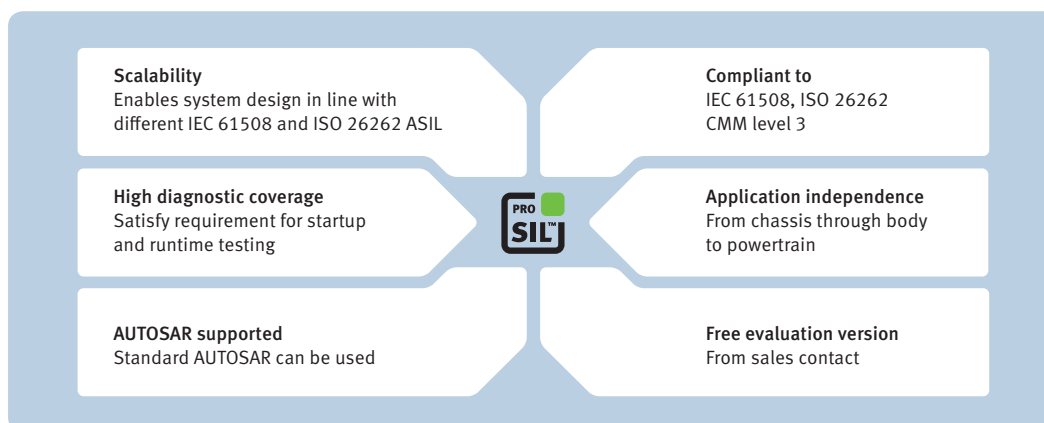





## TriCore™ for Powertrain Applications

### Energy Efficiency for Combustion Engine Vehicles

Electronic automotive components are key to raising fuel efficiency levels and cutting emissions. The latest environment protection agency standards – Euro 5 and Euro 6 for passenger cars and Euro 3 and Euro 4 for motorcycles – are driving developments in advanced engine management. TriCore™-based products can be found in improved combustion technologies such as Homogeneous Charge Compression Ignition (HCCI) as well as in direct injection, smart turbocharger and valve actuation applications. They are also ideal for a range of innovative transmission technologies such as Double Clutch Transmission (DCT) and modern Continuous Variable Transmission (CVT).

### Driving Hybrid and Electrification

While excelling in fuel economy, being fun-to-drive and reducing CO<sub>2</sub> emissions, Hybrid Electric Vehicles (HEV) and Electric Vehicles (EV) have the drawbacks of higher cost, limited drive-range and safety concerns (e.g. risk of battery over-charging). TriCore™ products, with their high performance, functional integration and application-based SW support, are the ideal solution for (H)EV motor drives. TriCore™ offers less than 6% CPU load at 180MHz frequency, for the complete Field Oriented Control (FOC) algorithm. TriCore™ AURIX™ family offers multicore architecture, allowing inverter control, hybrid torque management and DC/DC conversion to be done within one single microcontroller. Nevertheless, the TriCore™ AURIX™ family has built-in resolver functionality, saving customers the cost of implementing an external resolver IC.

Often seen as master micro in battery balancing topology, the TriCore™ AURIX™ family proposes a 32-bit standby domain combined with an integrated 8-bit standby controller, essential for battery balancing under low power mode (e.g. holiday parking). Its unique Secure Hardware Extension (SHE, details in next paragraph) feature prevents the main CPU from illegal manipulation, making the billing for battery charging more trustworthy.



### **In-Vehicle Security and Tamper-Proofing Electronic Control**

By introducing SHE (Secure Hardware Extension), Infineon has met the demand for improved tamper-proofing and anti-theft protection of automotive control units as expressed by the “HIS” (Manufacturers’ Software Initiative) Working Group on Security. This working group consists of Audi, BMW, Daimler, Porsche and Volkswagen. Security solutions have so far been confined to the software level or were coupled with additional external hardware, meaning they were easily circumvented. Infineon offers more than this basic software protection because AUDO MAX SHE monolithically integrates a secure keystore which cannot be read without access authorization.

In addition, SHE has a cryptographic module, which encrypts access codes with up to 128 bits. SHE is complemented by an array of hardware functions which, for example, prevent the application code from being illegitimately read and altered. Same risk can also apply to the identification of ECUs in the system network. These are important functions for tamper-proofing control units and protecting them against theft. Even if such an ECU were to be fitted in another identical vehicle, its engine performance characteristics could not be changed: the cryptographic individual key of an ECU has to match all the cryptographic keys within the ECU network of a vehicle. And that key is safely stored in the SHE.

The AUDO MAX microcontroller family incorporating SHE currently comprises three products, each with 4MB flash memory but differing in terms of clock frequency and package: TC1798 (300MHz, BGA-516), TC1793 (270MHz, BGA-416) and TC1791 (240MHz, BGA-292). Infineon’s future 65nm eFlash microcontrollers will offer and significantly extend the SHE functionality with a Hardware Security Module (HSM).

### Application Example

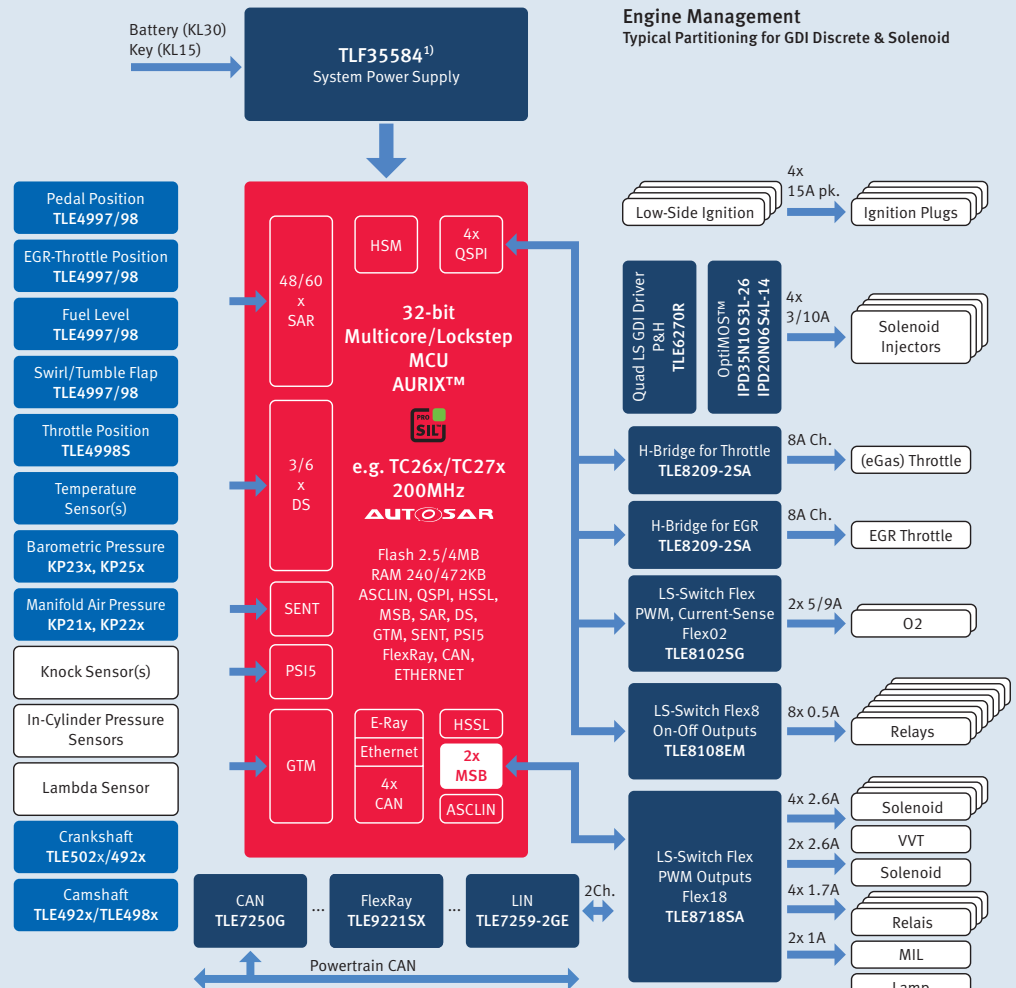

1) In development

## Gasoline Direct Injection

### Application Features

- Direct injection
- Scalable software-based knock detection
- Variable valve control
- Throttle and EGR control
- Turbo charging
- Catalyst after treatment
- Start/stop system

### System Benefits

- Microcontroller with best-in-class real-time performance
- Scalable platform – performance, memory size and I/Os
- Committed to reduce CO<sub>2</sub> by 20%
- Anti-theft protection and tuning protection
- Increased knock detection accuracy via DS-ADC
- Enhanced communication (Ethernet)
- Dedicated peripherals for powertrain

### Suggested Products

- TC27x – TriCore™ 32-bit Microcontroller
- TC26x – TriCore™ 32-bit Microcontroller





## Application Example

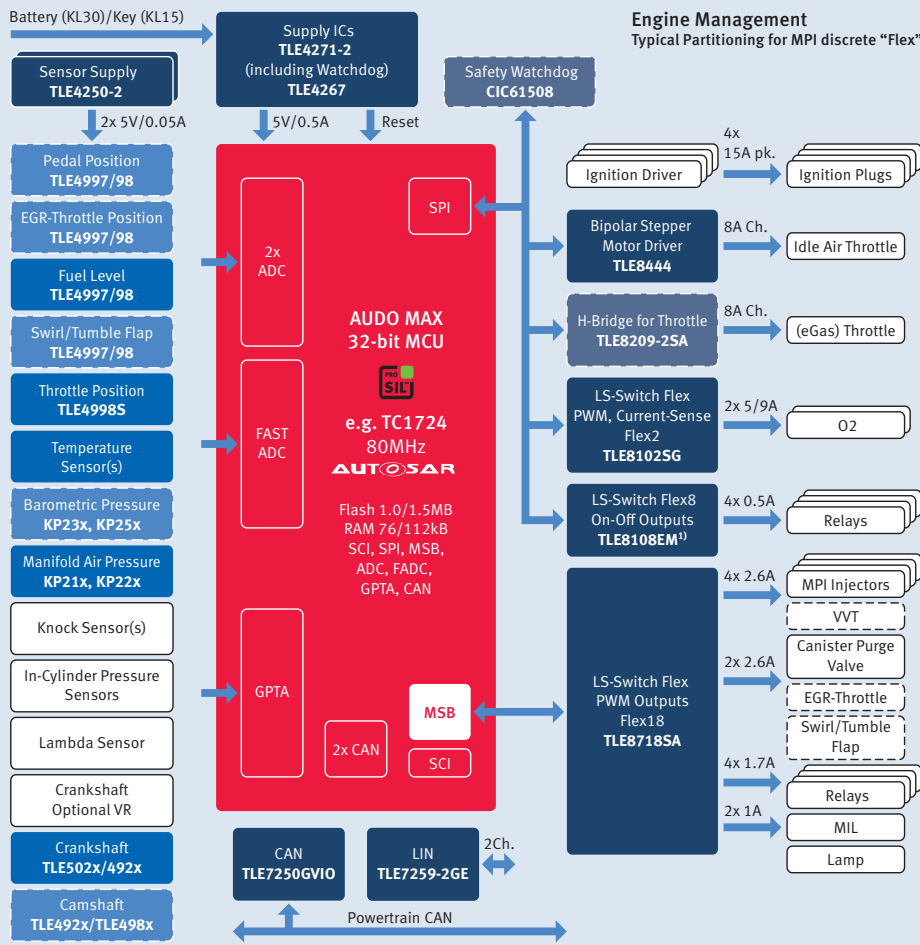

1) In development, samples available

## Gasoline Multi-Port Injection

### Application Features

- Gasoline port injection
- Scalable software-based knock detection
- Throttle and EGR control
- Catalyst after treatment
- Start/stop systems
- Cost-optimized for entry segment

### System Benefits

- Scalable platform – performance, memory size and I/Os
- Single voltage supply (EVR)
- Focus on reducing CO<sub>2</sub>
- Easy migration from ultra low-end to mid-range applications
- Best tool/partner support for all development phases within V-Cycle

### Suggested Products

- TC1724 – TriCore™ 32-bit Microcontroller
- TC1728 – TriCore™ 32-bit Microcontroller
- TC1736 – TriCore™ 32-bit Microcontroller



### Application Example

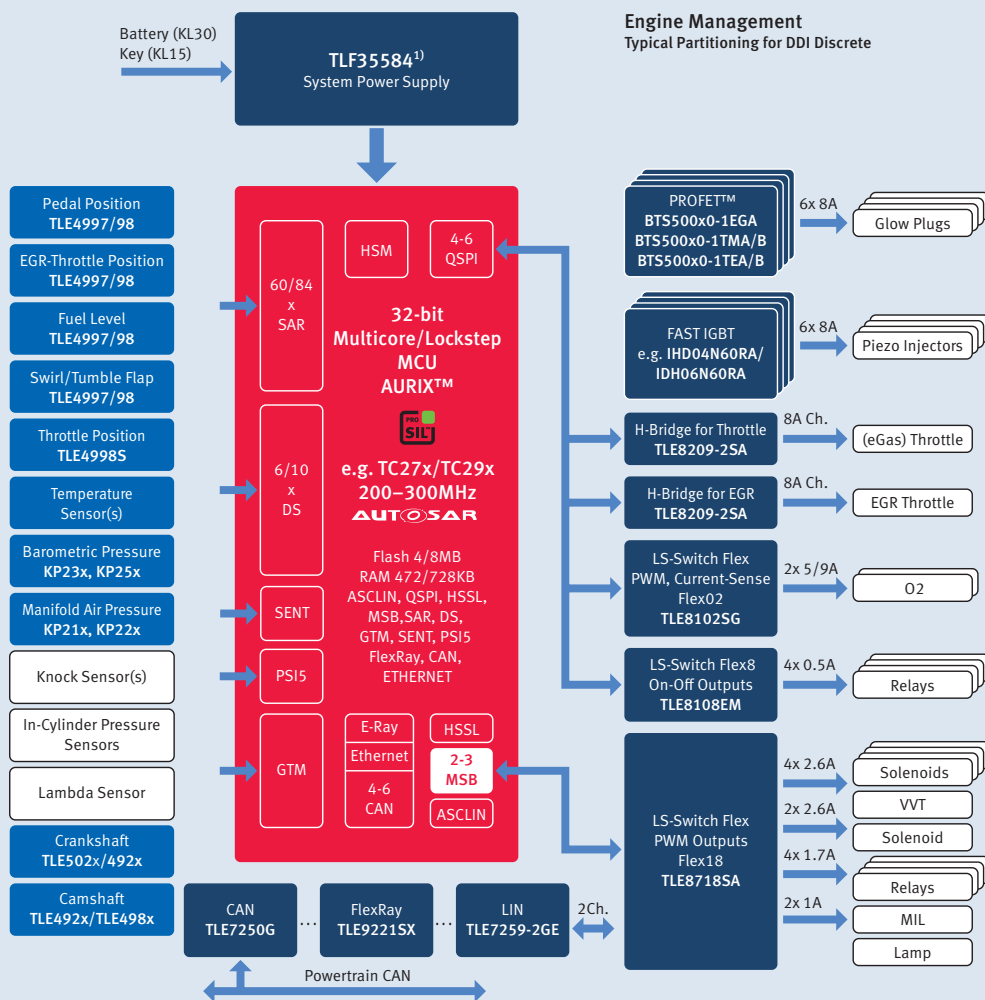

1) In development

## Diesel Direct Injection

### Application Features

- Direct injection (Piezo/Magnetic)
- In-cylinder pressure measurement
- Hardware-supported security enhancements
- Throttle and EGR control
- Turbo charging
- Diesel particulate filter
- ‘Blue’ after-treatment support (e.g. urea-based SCR)

### Suggested Products

- TC29x – TriCore™ 32-bit Microcontroller
- TC27x – TriCore™ 32-bit Microcontroller

### System Benefits

- Microcontroller with best-in-class real-time performance
- Scalable platform – performance, memory size and I/Os
- Committed to reduce NOx and particulate matter in line with Euro 6 standard
- Hardware-supported IP/anti-theft protection and tuning protection
- Increased accuracy with in-cylinder pressure sensing via DS-ADC
- Enhanced communication (Ethernet)
- Dedicated peripherals for powertrain



## Application Example

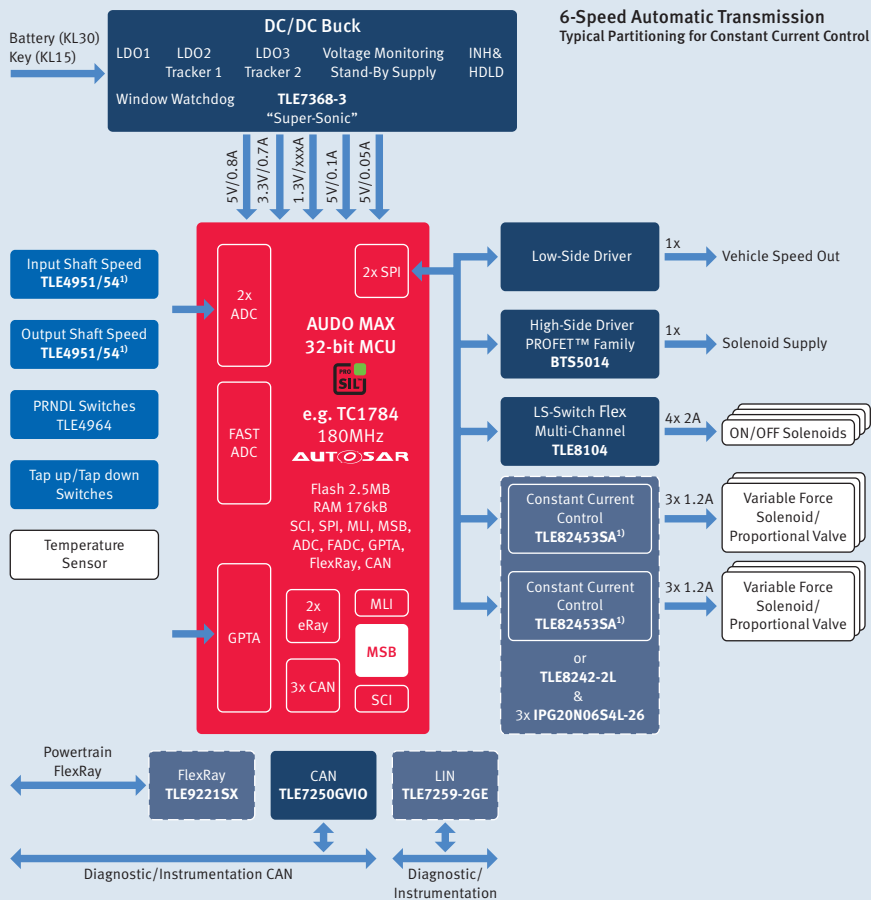

1) In development, samples available

## Automatic Transmission–Hydraulic Control

### Application Features

- Smooth gear shifting
- Closely coupled with engine control via high-speed CAN/FlexRay link
- Support for four 3-phase DC-brushless E-drives
- High microcontroller junction bare die temperature

### System Benefits

- Improved and fast clutch control
- Hot bare die supports modular temperature-optimized TCU design
- Hot bare die capabilities enable micro-controllers to be placed wherever they are needed in the system
- Digital Temperature Sensor (DTS) for increased accuracy
- Scalable product offering ensures perfect fit for individual application needs

### Suggested Products

- TC1746 – Bare Die TriCore™ 32-bit Microcontroller
- TC1748 – Bare Die TriCore™ 32-bit Microcontroller
- TC1784 – TriCore™ 32-bit Microcontroller





### Application Example

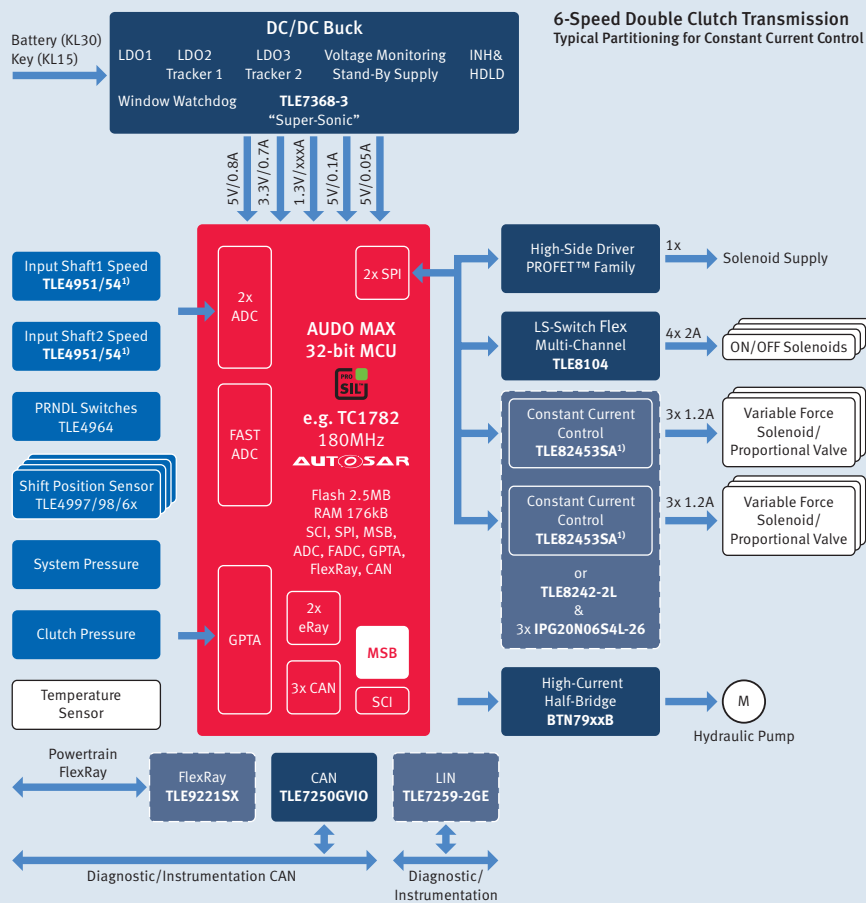

1) In development, samples available

## Dry Double Clutch Transmission– Hydraulic Control

### Application Features

- Ultra-fast gear switching
- Closely coupled with engine control via high-speed CAN/FlexRay link
- Support for four 3-phase DC-brushless
- E-drives (Dry-DCT)
- Microcontroller offered as bare die with junction temperature up to 170°C

### Suggested Products

- TC1746 – TriCore™ 32-bit Microcontroller
- TC1782 – TriCore™ 32-bit Microcontroller

### System Benefits

- Improved fast clutch control
- Feature set optimized for wet and dry DCT designs
- Continuous torque on wheels ensures a more fun driving experience
- Hot bare die capabilities enable micro-controllers to be placed directly where they are needed in the system
- Hot bare die supports modular temperature-optimized TCU design
- Digital Temperature Sensor (DTS) for increased accuracy



## Application Example

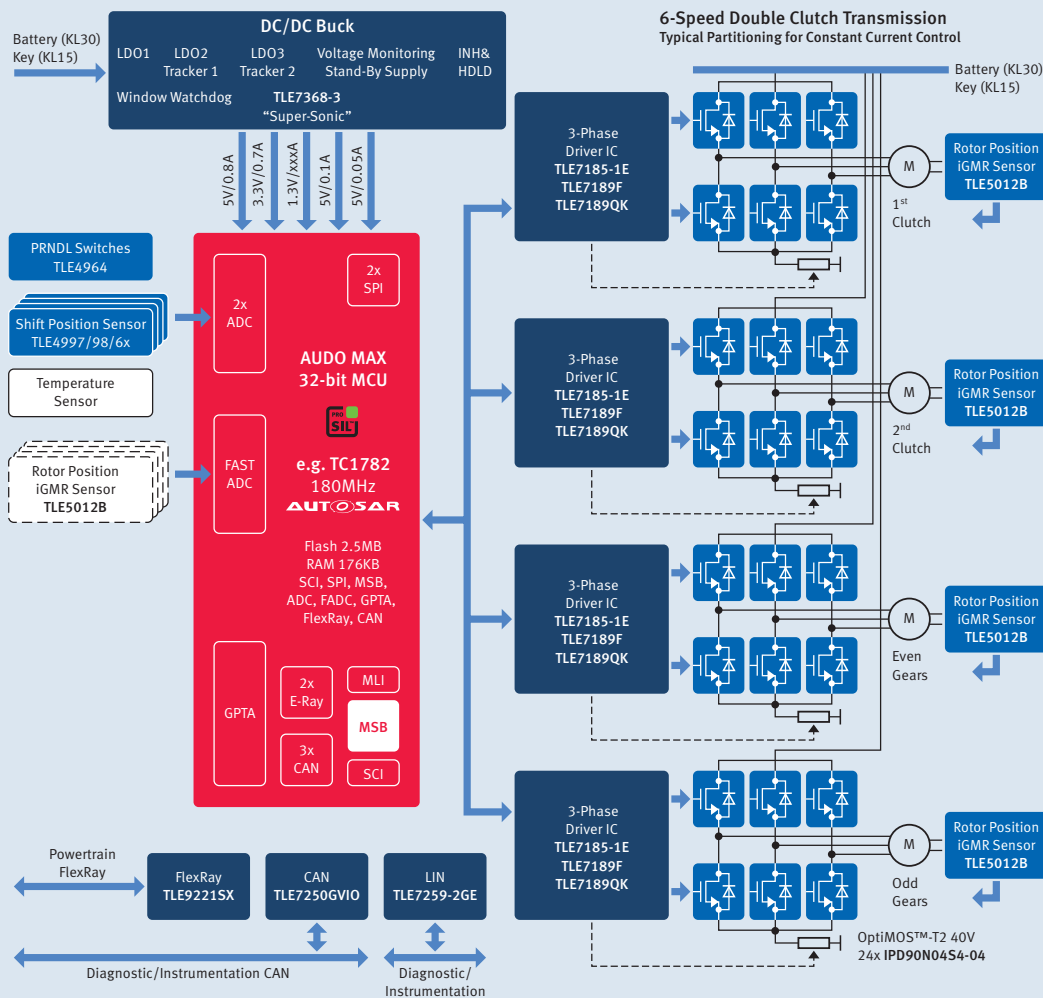

## Dry Double Clutch Transmission– Electrical Control

### Application Features

- Ultra-fast gear switching
- Closely coupled with engine control via high-speed CAN/FlexRay link
- Support for four 3-phase DC-brushless E-drives (Dry-DCT)
- Microcontroller offered as bare die with junction temperature of up to 170°C

### Suggested Products

- TC1746 – TriCore™ 32-bit Microcontroller
- TC1782 – TriCore™ 32-bit Microcontroller

### System Benefits

- Improved fast clutch control
- Feature set optimized for wet and dry DCT designs
- Continuous torque on wheels ensures a more enjoyable driving experience
- Hot bare die capabilities enable micro-controllers to be placed directly where they are needed in the system
- Hot bare die supports a modular temperature-optimized TCU design
- Digital Temperature Sensor (DTS) for increased accuracy
- Infineon e-Motor Driver



### Application Example

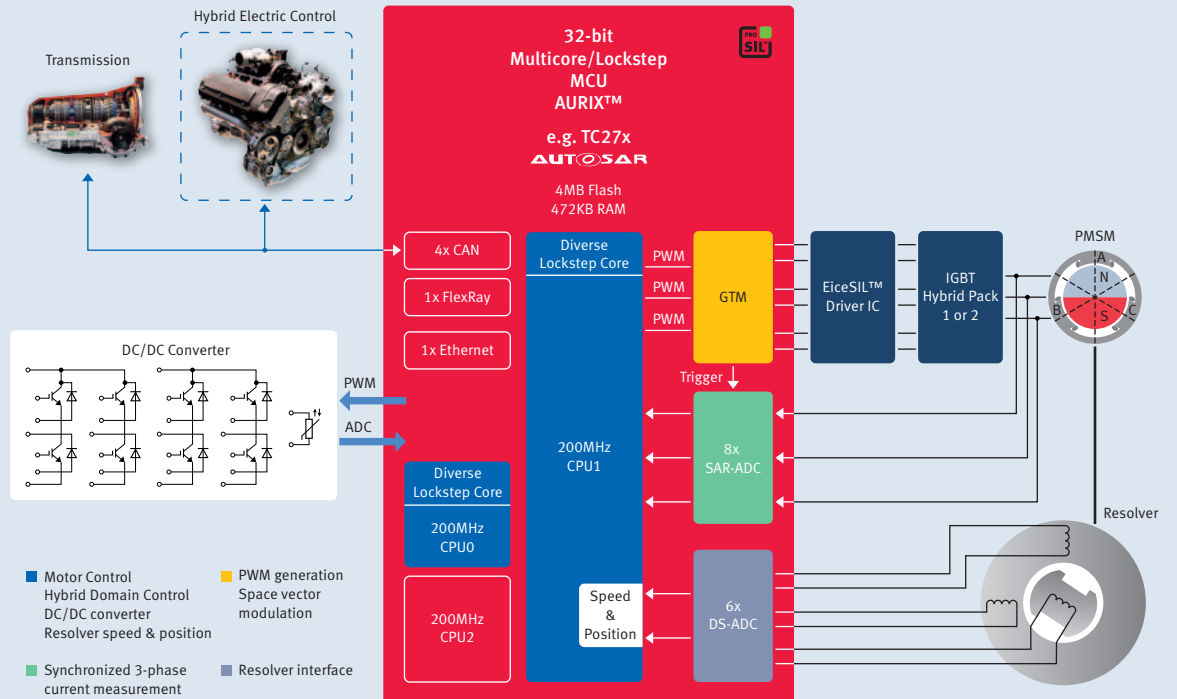

## Integrated (H)EV Control

### Application Features

- Multicore & Lockstep architecture
- Direct resolver-to-microcontroller
- Superior performance
- Customized PWM pattern generation

### System Benefits

- ISO 26262 ASIL-C/D compliant
- No resolver IC needed, lower system cost
- Enables sub-system integration (driving HCU + Inverter + DC/DC)
- Fine motor tuning

### Suggested Products

- TC27x – TriCore™ 32-bit Microcontroller
- TC26x – TriCore™ 32-bit Microcontroller



## Application Example

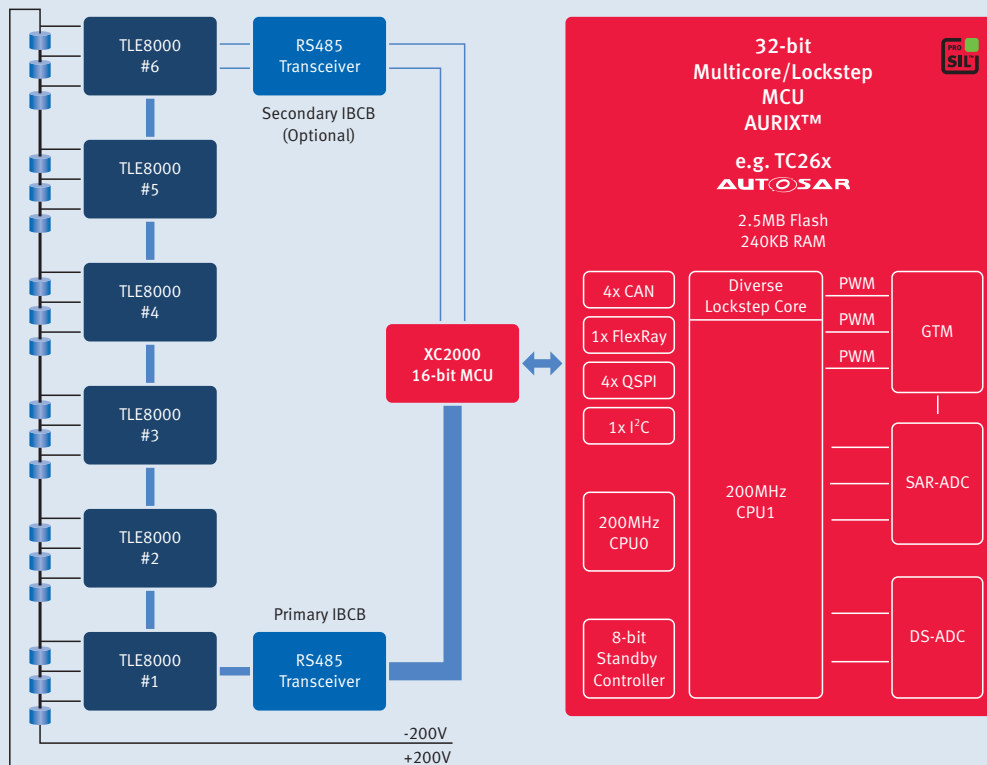

## (H)EV Battery Management System

### Application Features

- Multicore & Diverse Lockstep Core architecture
- Fast communication interface
- Integrated low-power 8-bit standby controller
- HW Security Module (HSM)

### System Benefits

- ISO 26262 ASIL-C/D compliant
- IBCB network architecture
- Ring topology in event of failure
- Balancing & monitoring over long parking period
- Charge-billing verification
- Active & passive balancing

### Suggested Products

- TC27x – TriCore™ 32-bit Microcontroller
- TC26x – TriCore™ 32-bit Microcontroller
- TLE8000 – battery balancing IC





## TriCore™ for Safety Applications

### **AURIX™ Made for Safety**

The AURIX™ architecture has been developed according to an audited ISO 26262 compliant process and designed to efficiently meet ASIL-D on an application level. The platform uses up to 2 cores in TriCore™ Diverse Lockstep Core technology, a diverse lockstep architecture combined with cutting-edge safety technology, such as safe internal communication buses or distributed memory protection system. Innovative encapsulation techniques allow the integration of software with various safety levels (QM to ASIL-D) from different sources, thereby significantly reducing system complexity. Thanks to this optimized approach, multiple applications and operating systems (such as steering, braking, airbag and advanced driver assistance systems) are seamlessly hosted on a unified platform. This leads to productivity gains of up to 30%, resulting in a smaller development outlay and reduced time-to-market for our customers.

Furthermore, Infineon extends the microcontroller safety roadmap with devices dedicated to the Advanced Driver Assistance System (ADAS) segment, such as radar or camera applications. Innovation has been focused on system partitioning in order to further integrate system functionality and consequently reduce the complexity and area, providing our customers with highly optimized solutions. The new devices include high-speed interfaces, integrated hardware acceleration and enhanced ECU validation and instrumentation tools. All ADAS devices have been designed in accordance with the ISO 26262 safety methodology, meaning that they can be involved in automatic decisions to assist drivers, such as emergency braking.





### **AURIX™ Made for Scalability**

Thanks to its market-leading expertise, Infineon has translated customer demands for individual scalability into a universal product roadmap. Designed to optimize its customers' investment, the AURIX™ family comes with a comprehensive range of fully modular components, thereby ensuring long-term design flexibility. The devices range in the ultra high-end from a 300MHz triple-core device with 8MB of embedded Flash to a 200MHz triple core with 4MB of embedded Flash to a 200MHz dual-core device with 2.5MB of embedded Flash right down to 130MHz and 80MHz single-core and single-core lockstep devices with 1.5MB, 1MB and 0.5MB of embedded Flash. The package portfolio includes a BGA-516 package with a ball-compatible BGA-292 package (I/O subset), and compatible QFP-176, QFP-144, QFP-100 to QFP-64 packages.

### Application Example

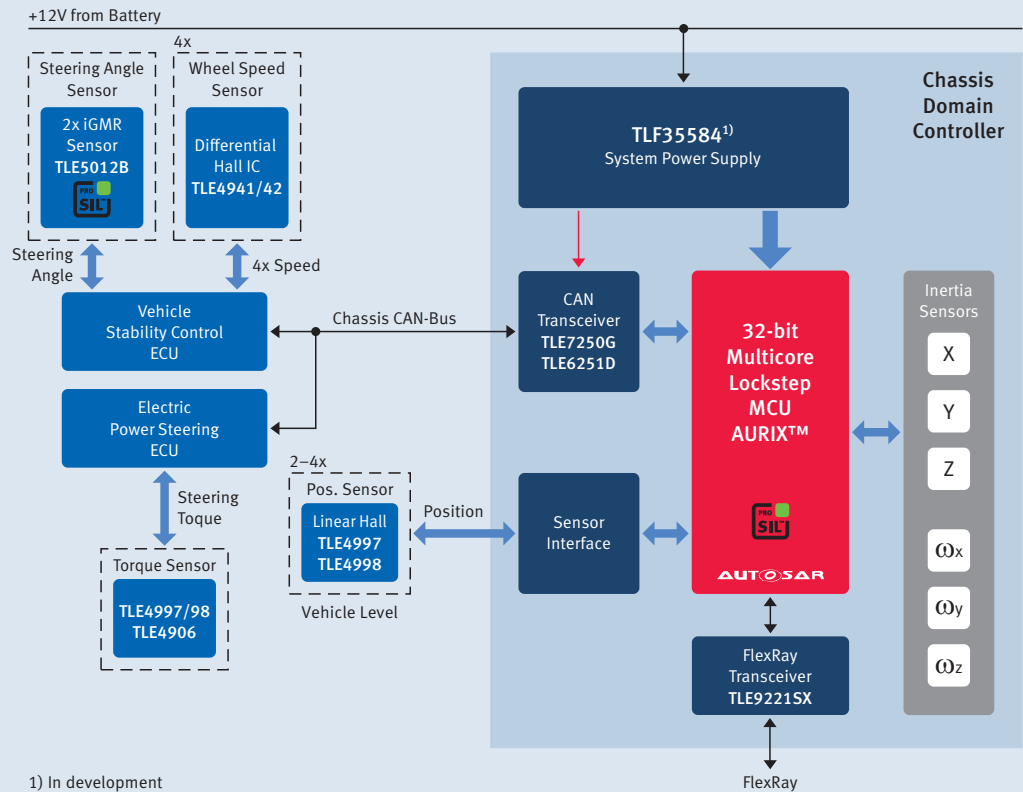

## Chassis Domain Control

The new TriCore™ family AURIX™ with state-of-the-art safety features enables systems to achieve the highest safety level ASIL-D, which is already required in contemporary domain control systems. The latest diverse lockstep technology with clock delay (Diverse Lockstep Core) reduces the software overhead significantly and enables fast time-to-market. Thanks to a scalable multicore system and innovative encapsulation techniques, this supports the integration of software with mixed-criticality levels from different sources, thereby allowing multiple applications and operating systems to be seamlessly hosted on a unified platform.

#### Application Features AURIX™

- TriCore™ DSP functionality
- Best-in-class performance: triple TriCore™ with up to 300MHz per core
- Supporting floating point and fix point with all cores
- Up to 2.7MB of internal RAM
- Communication peripherals: CAN, LIN, FlexRay, Ethernet
- Innovative single supply 5V or 3.3V
- External memory interface
- ISO 26262 conformance to support safety requirements up to ASIL-D
- Availability of AUTOSAR 4.x

#### System Benefits

- Advanced communication with FlexRay and Ethernet
- Highest available performance with integrated FPU
- Flexible DMA unit
- Scalability over Flash, RAM and peripherals
- Proven safety concept to support ISO 26262
- Innovative supply concept leads to best-in-class power consumption



## Application Example

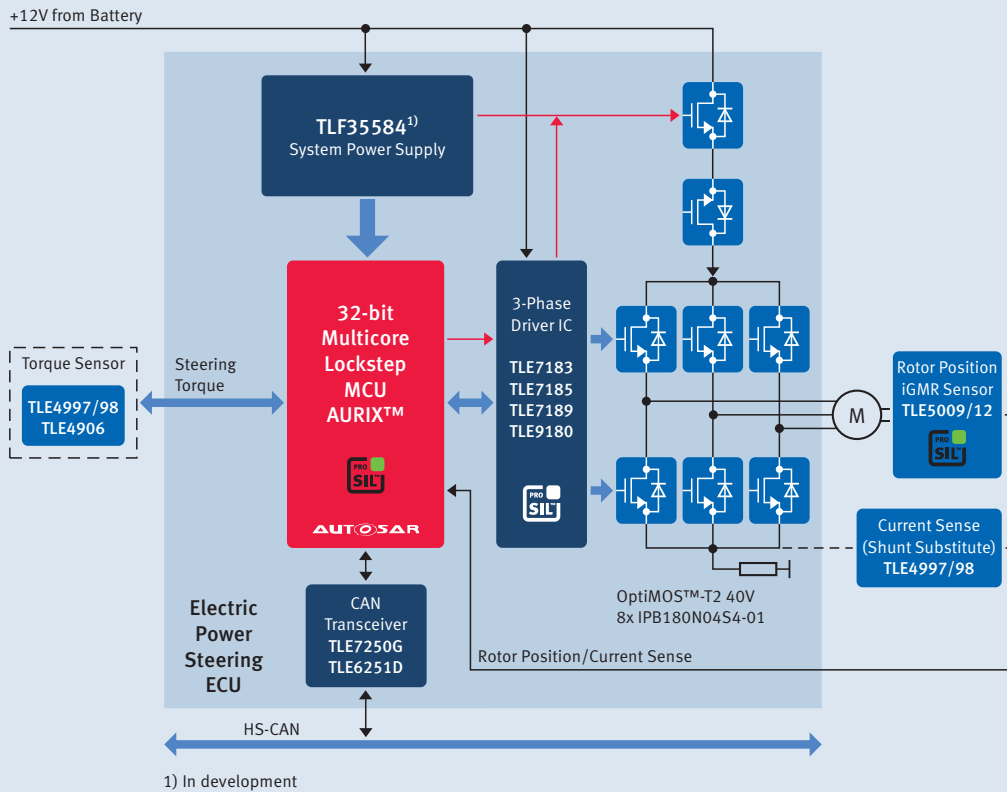

## Electric Power Steering (EPS)

The new TriCore™ family AURIX™ with state-of-the-art safety features enables systems to achieve the highest safety level ASIL-D, which is already required in contemporary steering systems.

The latest diverse lockstep technology with clock delay (Diverse Lockstep Core) reduces the software overhead significantly and enables fast time-to-market.

Its rich scalability meets a variety of different electric power steering system demands.

### Key Features AURIX™

- Flash 256KB–8MB
- Performance from 40MHz–3x 300MHz
- $T_a = -40^\circ\text{C} \dots 145^\circ\text{C}$
- Dedicated peripheral set: CAN, SPI, FlexRay
- Advanced timer unit for totally flexible PWM generation and hardware input capture
- Redundant flexible 12-bit ADC
- Hardware SENT interface for low CPU load
- Hardware-focused safety concept for reduced SW overhead
- Safety software: Infineon SafeTcore library
- ISO 26262 conformance to support safety requirements up to ASIL-D
- Availability of AUTOSAR 4.x

### System Benefits

- Scalability over Flash, RAM and peripherals offering the best cost-performance ratio
- Serves all kinds of EPS systems, such as column or belt drive
- Proven safety concept to support ISO 26262
- Innovative supply concept leads to best-in-class power consumption



## Application Example

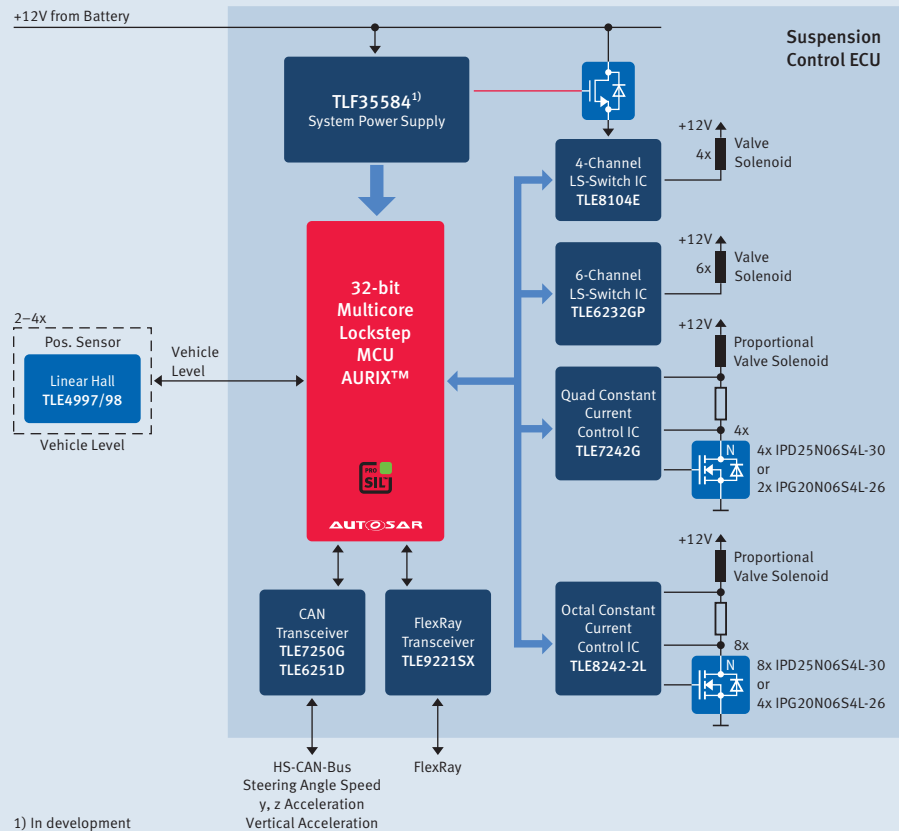

## Active Suspension Control System

The new TriCore™ family AURIX™ with state-of-the-art safety features enables systems to achieve the highest safety level ASIL-D, which is already required in contemporary suspension systems.

The latest diverse lockstep technology with clock delay (Diverse Lockstep Core) reduces the software overhead significantly and enables fast time-to-market.

The scalability supports an optimized fit in order to meet different OEM specifications.

### Application Features AURIX™

- TriCore™ DSP functionality
- Best-in-class performance: triple TriCore™ with up to 300MHz per core
- Supporting floating point and fix point with all cores
- Communication peripherals: CAN, LIN, FlexRay, Ethernet
- Innovative single supply 5V or 3.3V
- Wide range of packages from 64-Pin – 516-Pin
- ISO 26262 conformance to support safety requirements up to ASIL-D
- Availability of AUTOSAR 4.x

### System Benefits

- Scalability over Flash, RAM and peripherals offering the best cost-performance ratio
- Proven safety concept to support ISO 26262
- Innovative supply concept leads to best-in-class power consumption and saves external component costs





## Application Example

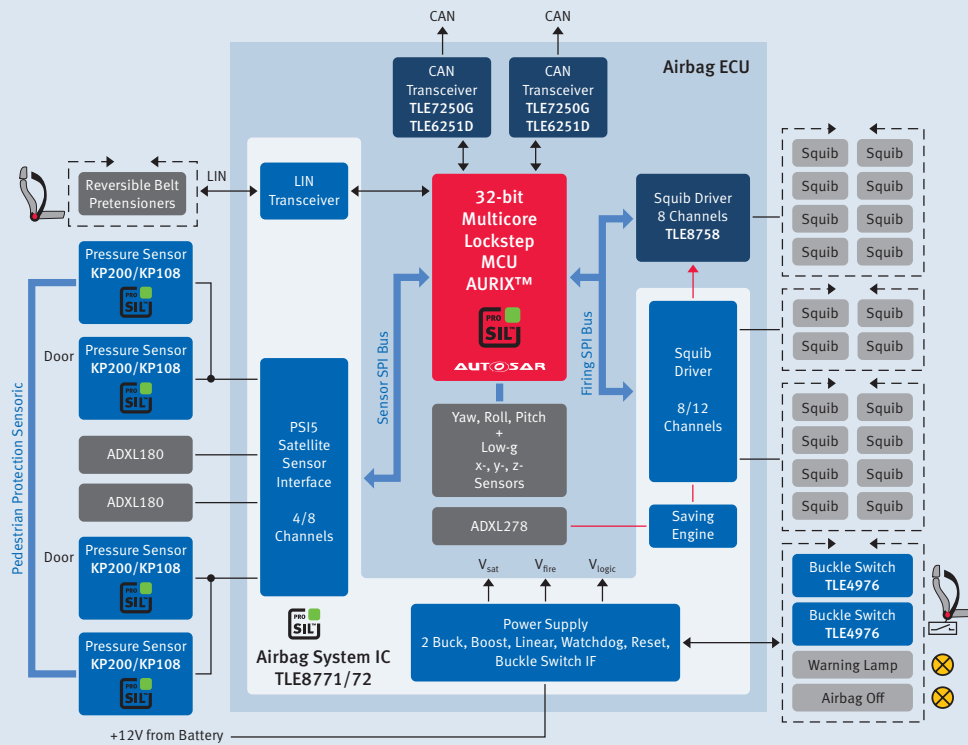

## Advanced Airbag System

The new TriCore™ family AURIX™ with state-of-the-art safety features enables systems to achieve the highest safety level up to ASIL-D.

The scalability allows the selection of a single-core solution for basic airbag systems and multicore solutions for airbag systems with an integrated sensor cluster.

The best cost-performance fit is offered by the wide range of Flash, performance and peripheral options available within the AURIX™ family.

### Application Features AURIX™

- Scalable MCU family from single to multicore
- Flash 256KB–8MB
- Embedded EEPROM
- Performance from 40MHz–3x 300MHz
- Dedicated peripheral set: CAN, SPI, FlexRay
- Hardware-focused safety concept for reduced SW overhead
- Safety software: Infineon SafeTcore library
- ISO 26262 conformance to support safety requirements up to ASIL-D
- Availability of AUTOSAR 4.x

### System Benefits

- Scalability over Flash, RAM and peripherals offering the best cost-performance ratio
- Proven safety concept to support ISO 26262
- Innovative supply concept leads to best-in-class power consumption



## Application Example

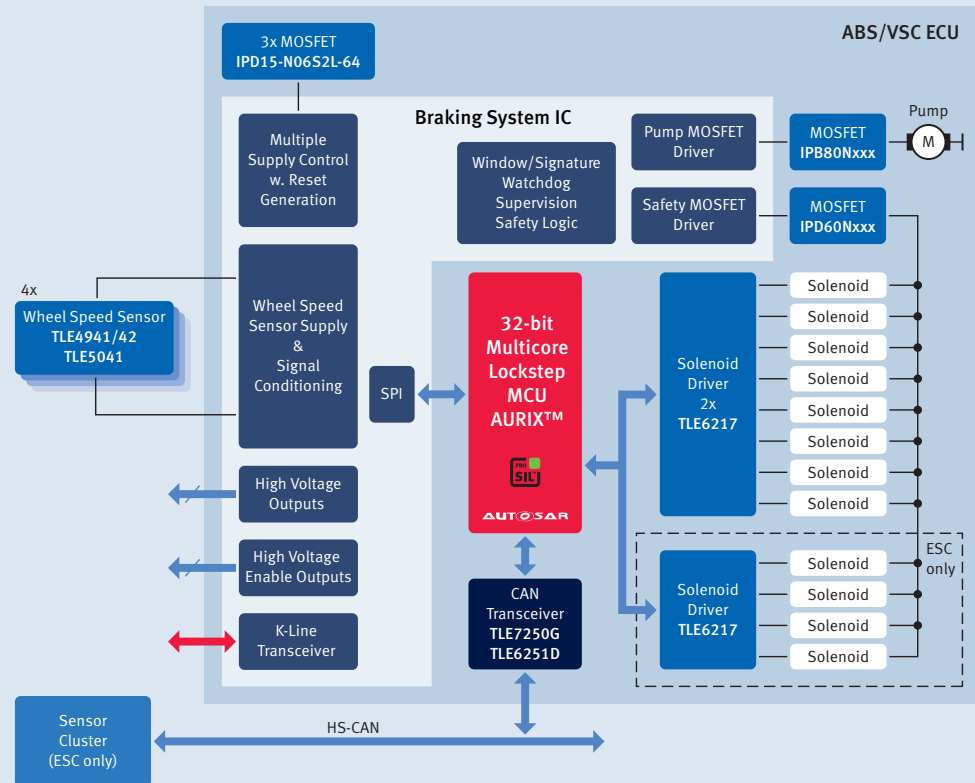

## Braking ECU

The new TriCore™ family AURIX™ with state-of-the-art safety features enables systems to achieve the highest safety level ASIL-D, which is already required in contemporary braking systems. The latest diverse lockstep technology with clock delay (Diverse Lockstep Core) reduces the software overhead significantly and enables fast time-to-market. The scalability supports an optimized cost-performance fit for basic ABS systems up to highly-integrated ESC systems.

### Key Features AURIX™

- Scalable MCU family with diverse lockstep
- Flash 256KB–8MB
- Performance from 40MHz–3x 300MHz
- Hardware-focused safety concept for reduced SW overhead
- SENT interface for low CPU load
- Safety software: Infineon SafeTcore library
- ISO 26262 conformance to support safety requirements up to ASIL-D
- Availability of AUTOSAR 4.x

### System Benefits

- Scalability over Flash, RAM, performance and peripherals leads to an optimized cost-performance fit
- Proven safety concept to support ISO 26262 validated by 3<sup>rd</sup> party
- Innovative supply concept leads to best-in-class power consumption and saves external component costs



## Application Example

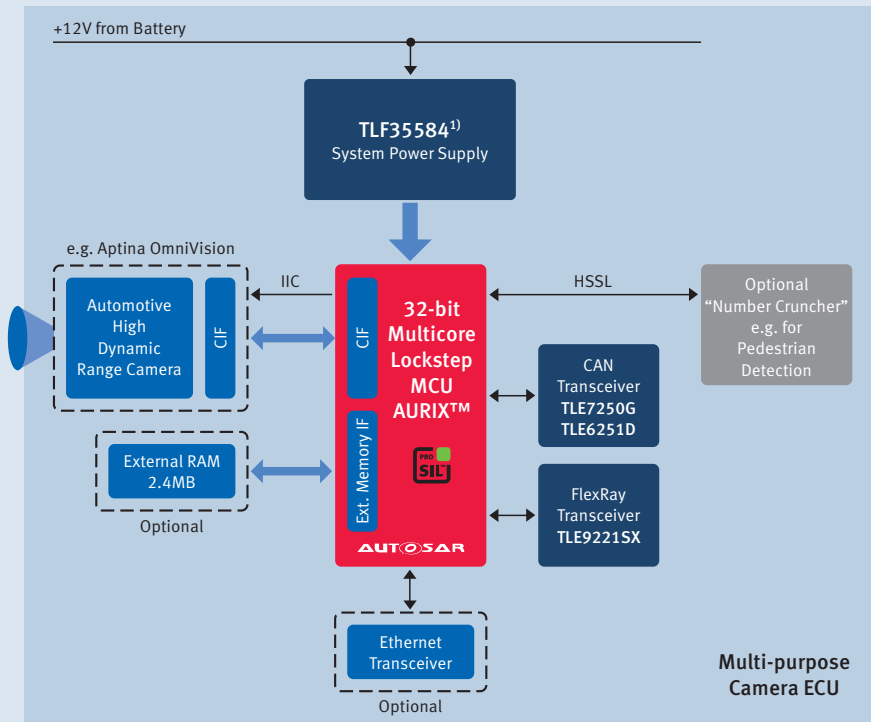

1) In development

## Multi-purpose Camera Configuration

The new TriCore™ family AURIX™ will enhance classic safety features with dedicated features to cater for multi-purpose camera systems.

The combination of new features, such as a picture pre-processing unit, camera interface, DSP functionality and increased SRAM, in conjunction with outstanding safety features enables a high level of scalability in order to achieve the best cost-performance ratio.

### Key Features AURIX™

- TriCore™ DSP functionality
- Best-in-class performance: triple TriCore™ with up to 300MHz per core
- Supporting floating point and fix point with all cores
- Up to 2.7MB of internal RAM for picture information storage
- Picture pre-processing unit
- Camera interface up to 100MHz
- Innovative single supply 5V or 3.3V
- External memory interface
- ISO 26262 conformance to support safety requirements up to ASIL-D
- Availability of AUTOSAR 4.x

### System Benefits

- High scalability option allows a dedicated performance feature fit for multiple camera applications from single automatic high beam systems up to multi-function systems (lane departure warning, forward collision warning, traffic sign recognition, pedestrian recognition etc.)
- High integration leads to reduced complexity
- Support for ISO 26262 decisions such as emergency braking
- Innovative supply concept leads to best-in-class power consumption



### Application Example

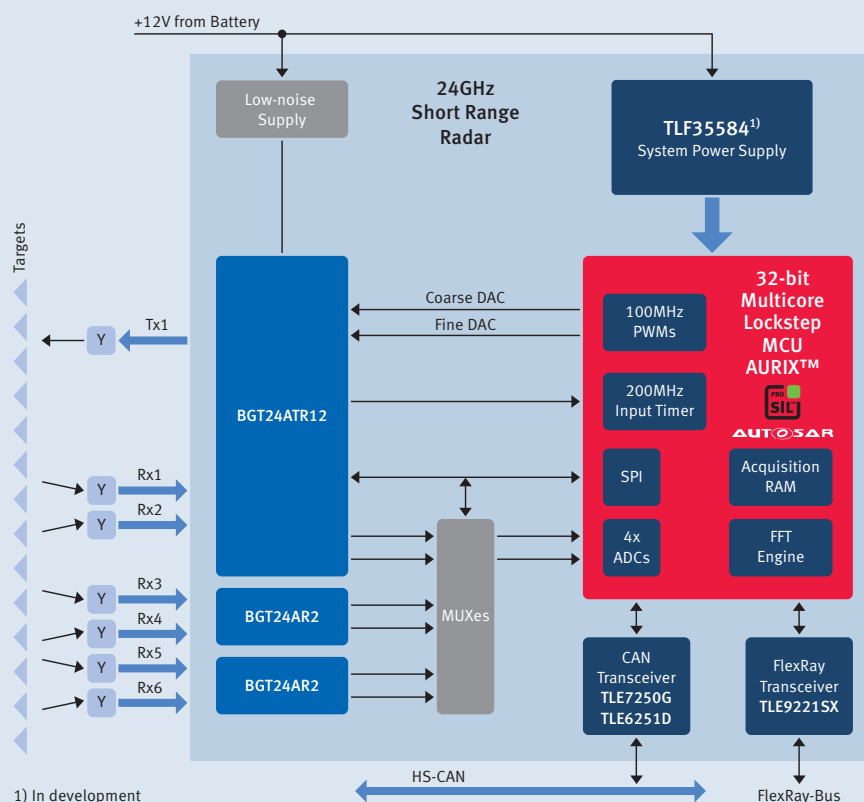

## Short Range RADAR (24GHz) System

The new TriCore™ family AURIX™ will enhance classic safety features with dedicated features to serve the needs of 24GHz RADAR systems.

The combination of new features and increased SRAM, in conjunction with outstanding safety features, enables a high level of integration and reduction of complexity.

#### Key Features AURIX™

- Up to 752KB RAM for RADAR image storage
- RADAR signal processing with windowing functionality
- Flexibility in RADAR signal acquisition with 4x internal ADCs
- Possibility to connect external ADCs (Interface to connect up to 16-bit ADCs)
- High-precision input timers
- High-precision output timers for DAC
- Innovative single supply 5V or 3.3V
- ISO 26262 compliance to support safety requirements up to ASIL-D
- Availability of AUTOSAR 4.x

#### System Benefits

- High integration leads to significant cost savings
- High integration leads to reduced complexity
- ISO 26262 compliance supports safe input for functions such as emergency braking
- Innovative supply concept leads to best-in-class power consumption





## Application Example

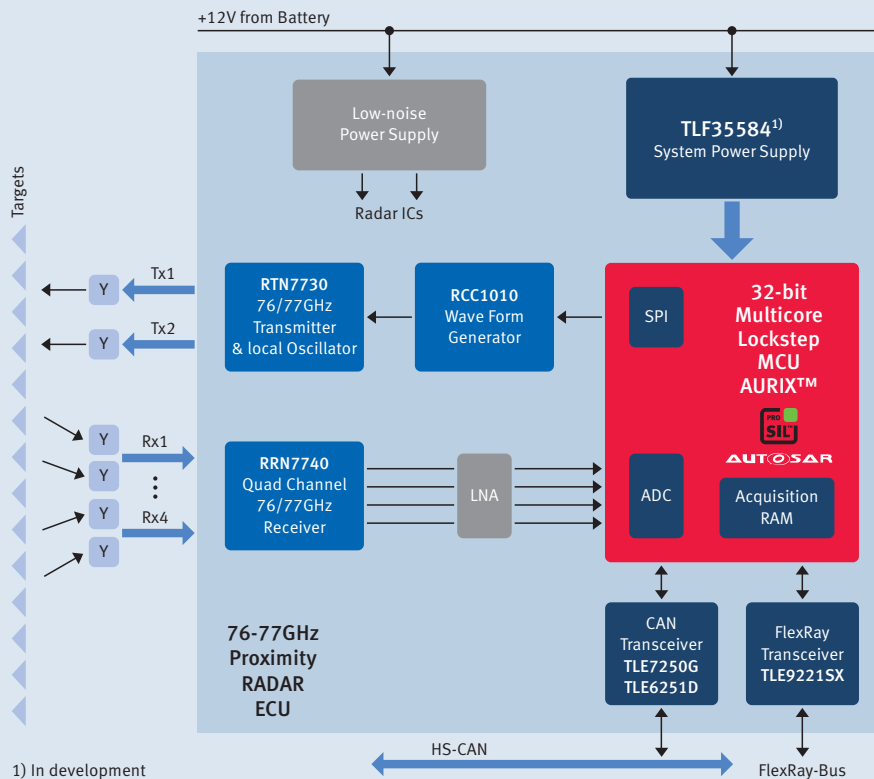

## Long Range RADAR (76/77GHz) System

The new TriCore™ family AURIX™ will enhance classic safety features with dedicated features to serve the needs of 77GHz RADAR systems.

The combination of new features and increased SRAM, in conjunction with outstanding safety features, enables a high level of integration and reduction of complexity.

### Application Features AURIX™

- TriCore™ DSP functionality
- Best-in-class performance: triple TriCore™ with up to 300MHz per core
- Up to 2.7MB RAM for RADAR image storage
- RADAR signal processing with windowing functionality
- Flexibility in RADAR signal acquisition with 4x internal ADCs
- Possibility to connect external ADCs (Interface to connect up to 16-bit ADCs)
- High-precision input timers
- High-precision output timers for DAC
- Innovative single supply 5V or 3.3V
- External memory interface
- ISO 26262 compliance to support safety requirements up to ASIL-D
- Availability of AUTOSAR 4.x

### System Benefits

- High integration leads to significant cost savings
- High integration leads to reduced complexity
- ISO 26262 compliance supports safe input for functions such as emergency braking
- Innovative supply concept leads to best-in-class power consumption





## TriCore™ for Body Applications

**Body electronics systems** embrace a broad variety of applications inside the car, covering comfort, safety and security as well as high-performance computing and in-vehicle networking. **This leads to the key strengths of the AURIX™ family:**

- **AUTOSAR** – With AUTOSAR 4, multicore architectures can be easily designed into vehicles. Infineon is one of the first implementers of a multicore architecture with AURIX™ ready for AUTOSAR 4.x. Furthermore, Infineon also provides the MCAL drivers developed according to CMM 3 level.
- **Power Consumption** – Innovative supply concept automatically adapts the power consumption to the actual performance needs. Furthermore, the new trend of pre-tended networking and ECU degradation is actively supported.
- **Enhanced communication** – As cars incorporate an increasing amount of electronics, the body electronics module's responsibilities increase to handle the additional components and message traffic. Because of the gateway functionality of the BCM, the AURIX™ has enhanced communication capabilities to support communication between CAN, LIN, FlexRay™ and Ethernet buses.
- **Safety** – The trend is toward the integration of safety targets in the requirements of advanced body systems such as lighting, BCM etc. To achieve the required ASIL level according to ISO2626, AURIX™ has the capability to cover targets up to the highest safety integrity level ASIL-D.
- **Security** – In the future, the need for a high level of security will also expand into body applications. Cars are expected to hold even more information as they become smart cards on wheels to simplify financial transactions at gas pumps, charging stations, parking lots, toll booths, drive-through shops and more. The vehicle will act as a smart card and pay your fee/fare – sometimes automatically. Hardware-based security is more robust than software-only security. AURIX™ provides a dedicated module, HSM (Hardware Secure Module), to cover the highest level of security.

## Application Example

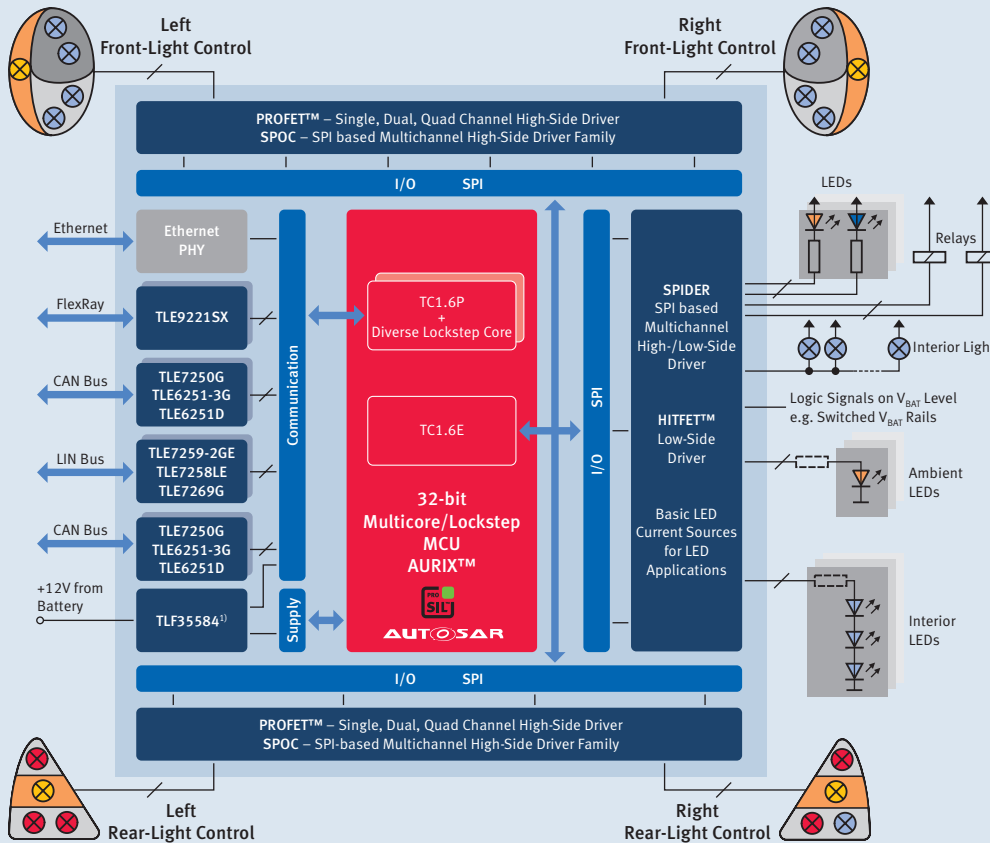

1) In development

# High-Feature Body Control Module with Integrated Gateway Functionality

Body Control Module (BCM) application comprising internal and external lighting systems, as well as control of relays and voltage rails and further comfort functions such as door and wiper control. The central gateway manages all internal interfaces (i.e. motor management, in-car entertainment, dashboard or convenience control) and communication with external interfaces for after-sales software updates. The AURIX™ multicore concept enables the integration of two applications in one device, e.g. BCM and Gateway

### Key Features

- Scalable MCU family from single to multicore
- Encapsulation feature allows software development without interference for multiple applications
- Embedded EEPROM
- Advanced communication peripherals: CAN, LIN, SPI, FlexRay, Ethernet
- ISO26262 conformance to support safety requirements up to ASIL-D
- Availability of AUTOSAR 4.x

### System Benefits

- Enables pretended networking and ECU degradation
- High integration leads to significant cost savings
- High integration leads to reduced complexity
- ISO26262 compliance supports ASIL requirements
- Innovative supply concept leads to best-in-class power consumption







## TriCore™ for Industrial Applications

### High Performance for Demanding Applications

While the primary focus of the TriCore™-based microcontrollers is on the automotive market, they also provide significant advantages for industrial applications. Featuring a combination of high calculation performance, large memory sizes, a comprehensive set of peripherals and integrated safety & security measures, the MCUs can meet even the most demanding application requirements.

The devices of the AUDDO MAX family reach more than 400 DMIPS at clock rates of up to 300MHz and combine MCU & DSP instructions with an integrated FPU. Memory sizes reach up to 4MB Flash and 192KB of SRAM and all memory is protected by hardware Error Correction Code (ECC).

The integrated peripheral set is primarily targeted toward motor control and power conversion providing up to 4 ADCs, an additional fast ADC and a full set of high-performance timers – namely the General Purpose Timer Array (GPTA). This is one of the very few in the industry that is able to drive the upcoming three-level inverter topologies.





### Providing Security and Functional Safety

In a global economy, IP protection plays an increasingly important role. This demand is accounted for by the integration of special security modules providing the required means of safe key storage, along with secure boot and encryption on the hardware level. As one of the leaders in functional safety, Infineon has designed the TriCore™ MCUs to meet the growing demand for functional safety in the industrial market as specified in IEC 61508. Via our cooperation partner Hitex, Infineon offers a complete package comprising a microcontroller, external signature watchdog (CIC61508), software and documentation, achieving safety integrity levels up to SIL3.

The next generation of TriCore™-based microcontrollers – AURIX™ – will provide another significant performance milestone by integrating up to three cores in one device. The multicore concept is targeted at running concurrent applications in parallel. Some of the integrated cores integrate lockstep functionality and the peripherals can be allocated to individual cores. This allows running a combination of safety-critical tasks, such as controlling an inverter, with non-critical tasks, such as network communication, on a single MCU.

### Application Example

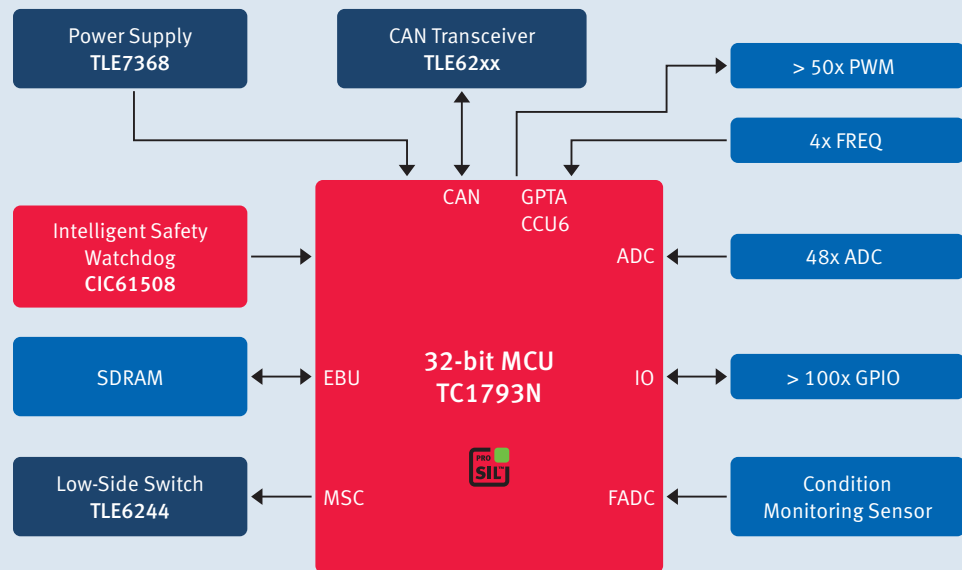

## Mobile Controller

### Application Features

- Closed-loop control of solenoid currents
- Multitasking to drive hydraulic and electric actuators
- IEC 61131-3 support
- GNU toolchain
- Ready for harsh environments
- Compliance with IEC 61508 for Safety
- Integrity Level (SIL) 1 to 3

### System Benefits

- High-speed 270MHz asymmetric dual core
- Up to 50 Pulse-Width-Modulated (PWM) outputs
- Three Analog to Digital Converters (ADC)
- 12-bit, up to 44 channels
- Four fast ADC inputs 10-bit (262.5ns @  $f_{FADC} = 80\text{MHz}$ )
- Four frequency inputs
- Fast, 10-bit ADC
- Industrial and automotive temperature range
- SAE J1939 supported by four CAN nodes
- 32KB EEPROM for parameter
- Hitex PRO-SIL™ support

### Suggested Products

- TC1793N – TriCore™ 32-bit Microcontroller
- TC1798N – TriCore™ 32-bit Microcontroller



## Application Example

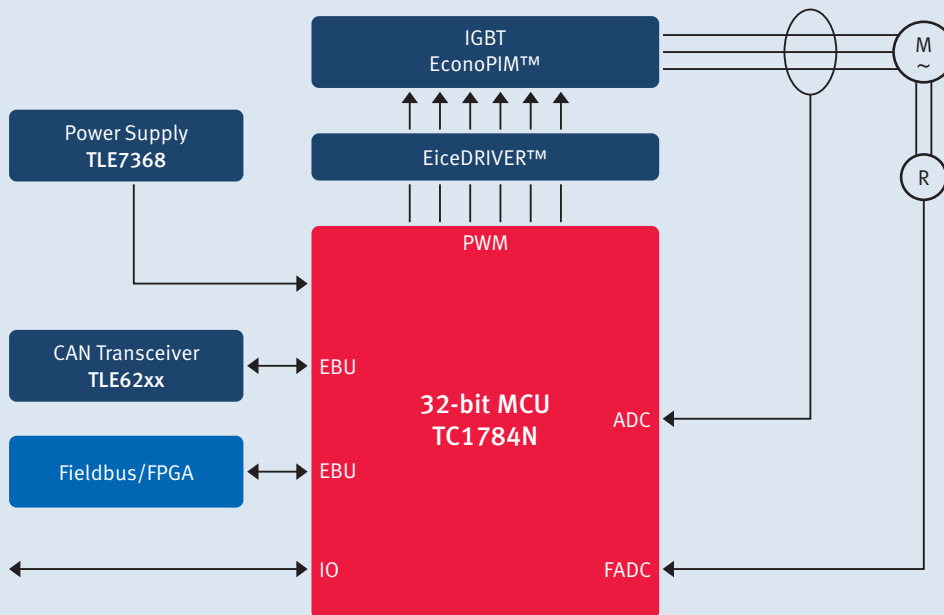

## Inverter

### Application Features

- Multi-axis controller for two 3-phase complementary PWMs
- Multiple modulation strategies (SVPWM, DPWM, Soft-PWM, direct torque control) to support requirements for reduced noise emissions and increased efficiency
- Ready for four Q-inverters, matrix-inverters
- Field-oriented control with less than 10% CPU load
- Multiprocessor support for reliability and safety
- Support for 3-Level inverter topologies

### System Benefits

- Generic flexibility timer (GPTA)
- Two Analog to Digital Converters (ADC) 12-bit, up to 32 channels
- Fast, 10-bit ADC (262.5ns @  $f_{FADC} = 80\text{MHz}$ )
- Resolver I/F
- Encoder I/F with digital noise filter
- Optimized motion control library
- Very fast control loop

### Suggested Products

- TC1784N – TriCore™ 32-bit Microcontroller

### Application Example

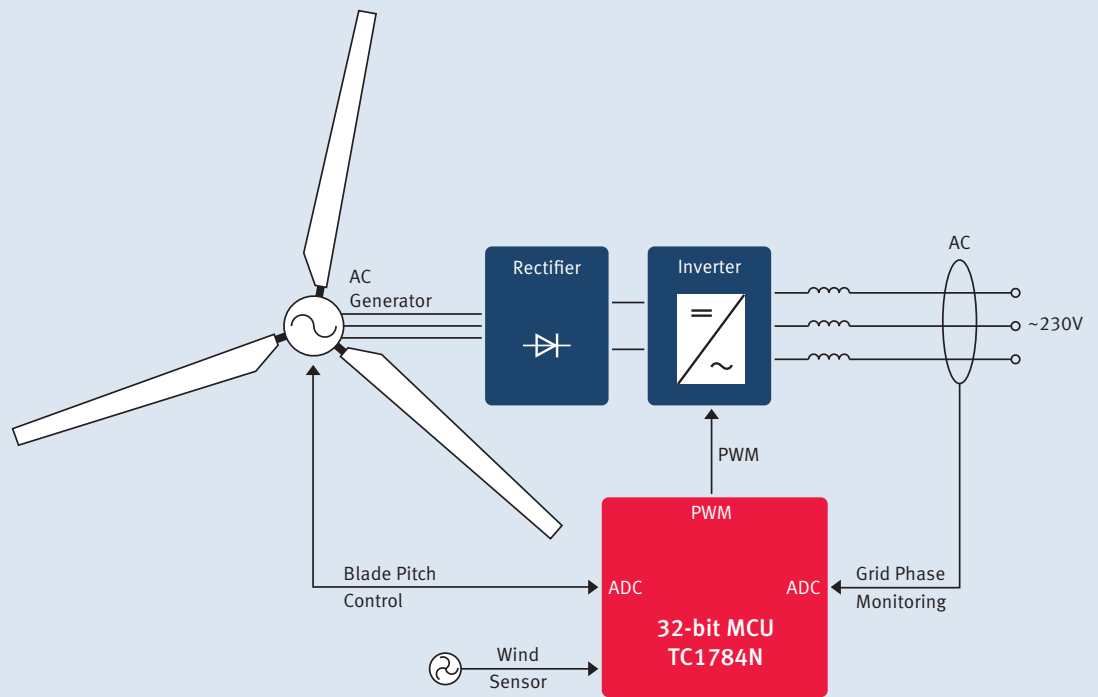

## Wind Turbine Inverter

### Application Features

- Reliable blade pitch control
- Increased wind turbine efficiency
- Multiple modulation strategies (SVPWM, DPWM, Soft-PWM, direct torque control) to support requirements for reduced noise emissions and increased efficiency
- Multiprocessor support for reliability and safety
- Support for 3-level inverter topologies

### System Benefits

- Generic flexibility timer (GPTA)
- Two Analog to Digital Converters (ADC) 12-bit, up to 36 channels
- Fast, 10-bit ADC (262.5ns @  $f_{FADC} = 80\text{MHz}$ )
- Resolver I/F
- Encoder I/F with digital noise filter
- Optimized motion control library

### Suggested Products

- TC1782N – TriCore™ 32-bit Microcontroller
- TC1784N – TriCore™ 32-bit Microcontroller

## Application Example

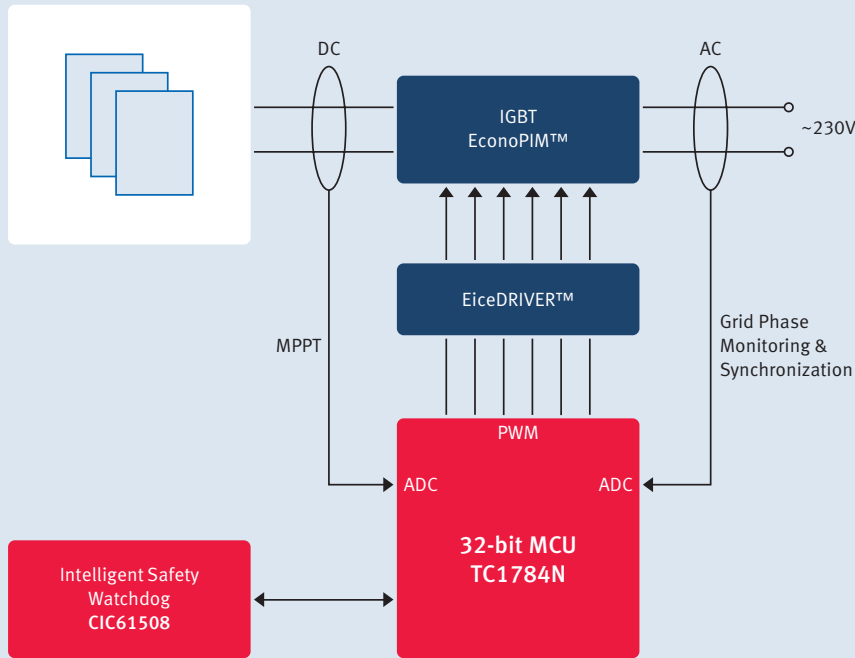

## Solar Panel

### Application Features

- Multi-phase PWM controller for single or multiple strings
- Runs multiple modulation strategies (SVPWM, DPWM, Soft-PWM, direct torque control) to support requirements for reduced noise emissions and increased efficiency
- Maximum Power Point Tracking (MPPT) to extract maximum power from solar panels
- Grid phase monitoring and synchronization to ensure power factor unity
- Current control to avoid disharmonics and to determine the feed in refund
- Support for 3-level inverter topologies

### Suggested Products

- TC1784N – TriCore™ 32-bit Microcontroller
- TC1793N – TriCore™ 32-bit Microcontroller

### System Benefits

- Generic flexibility timer (GPTA)
- Two Analog to Digital Converters (ADC) 12-bit, up to 36 channels
- Fast, 10-bit ADC (262.5ns @  $f_{FADC} = 80\text{MHz}$ )
- Optimized DSP library

### Maximum Power Point Tracking (MPPT)

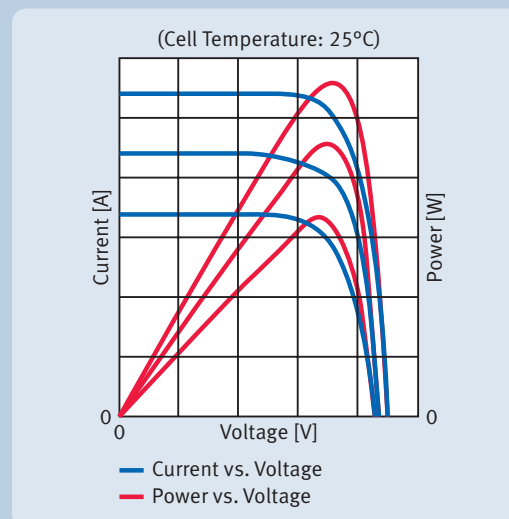



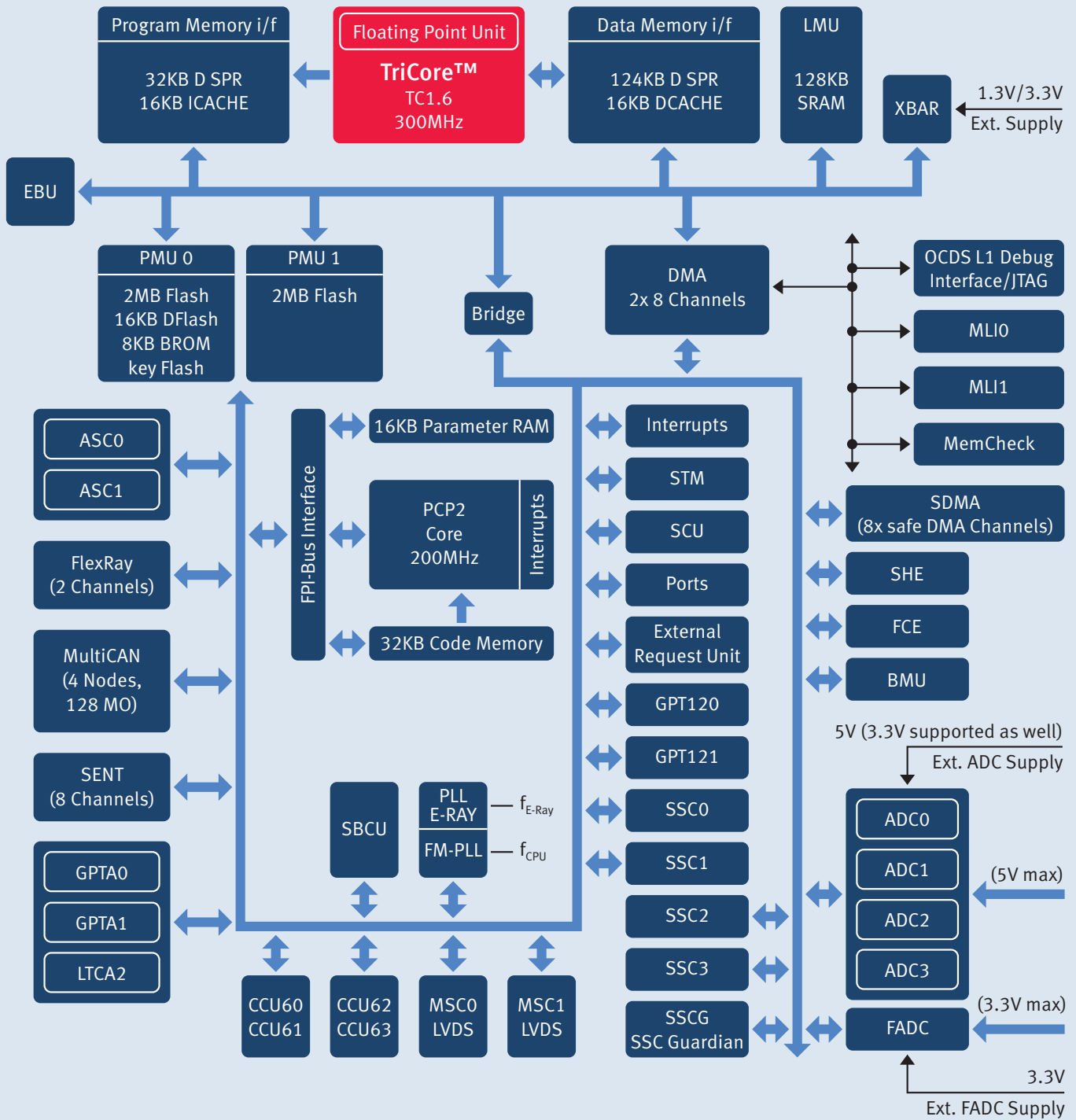

AUDO MAX TriCore™ TC1798 Architecture

# AUDO Family System Architecture

TriCore™ is the first unified, single-core 32-bit-microcontroller DSP architecture that has been optimized for real-time embedded systems. The TriCore™ Instruction Set Architecture (ISA) combines the real-time capability of a microcontroller, the computational power of a DSP plus the high performance and price features of an RISC load/store architecture in a compact reprogrammable core.

The ISA supports a uniform, 32-bit address space with optional virtual addressing and a memory-mapped I/O. It enables a wide range of implementations, from scalar to superscalar, and is capable of interacting with different system architectures, including multiprocessing environments. This flexibility at implementation and system level enables manufacturers to balance performance and cost requirements to meet individual needs.

The architecture supports both 16-bit and 32-bit instruction formats. 16-bit instructions are a subset of 32-bit instructions and were chosen due to their widespread popularity. They also significantly reduce code space and memory requirements, as well as system and power consumption.

Real-time responsiveness is largely determined by interrupt latency and context switch time. The high-performance architecture minimizes interrupt latency by avoiding long multi-cycle instructions and providing a flexible hardware-supported interrupt scheme. The architecture also supports fast context switching.

The Peripheral Control Processor (PCP2) is a programmable, single-cycle, 32-bit processing unit with its own code and data memory unit (Harvard architecture). It is used as an interrupt service provider, delivering hardware interrupt priority arbitration with 255 priority levels. Instead of static implementation, the PCP provides programmable improved peripheral intelligence.

The General Purpose Timer Array (GPTA) delivers extremely flexible filtering and high-resolution signal acquisition, as well as a digital PLL to generate higher resolution input signals. It enables all types of enhanced counting, capture/compare and PWM functionality thanks to its universal cell structure.

Floating Point Unit

**TriCore™**  
TC1.6  
300MHz

## TriCore™ TC1.6

---

### Features

- Up to 300MHz
- Six-stage pipeline
- Dedicated integer division unit in hardware
- Optimized Floating Point Unit (FPU)
- Enhanced branch prediction (branch history and target buffers)
- Optimized crossbar interconnect with 64-bit data width (shared resource interconnect)
- 16-bit and 32-bit instruction formats
- 32-bit load-store Harvard architecture
- Superscalar execution
- Sustained throughput by dual 16x32 MACs
- SIMD (Single Instruction Multiple Data) packed arithmetic
- Zero overhead loops (loop recognition buffer)

- DSP addressing modes and saturated math

### Benefits

- Highest performance for complex engine management systems
- Integrated MCU-DSP instructions in one core
- Very fast context switching for interrupt driven system
- Fast and efficient processing of multiple tasks on one engine
- Low code size and inherent high level language support
- One development toolset for both MCU and DSP tasks
- Higher flexibility and lower cost
- Support and supply of complete system chipset

## Peripheral Control Processor (PCP2)

---

### Features

- Moves data between any two memory or I/O locations
- Up to 200MHz
- Read-modify-write capabilities
- Full computation capabilities including basic MUL/DIV
- Reads/moves data and adds it to previously read data
- Reads two data values and performs arithmetic or logical operations and stores results

- Bit handling capabilities (testing, setting, clearing)
- Flow control instructions (conditional/unconditional jumps, breakpoint)

### Benefits

- Data preconditioning
- First level of defense for frequently occurring peripheral interrupts
- Programmable implementation of state machines
- Intelligent DMA assistance

PCP2  
Core  
200MHz

Interrupts

## SRAM

---

### Features

- Up to 288KB
- Overlay RAM
- Error Code Correction (ECC) with Single Error Correction (SEC) and Double Error Detection (DED)

### Benefits

- Fast memory access
- Safety

#### SRAM

288KB RAM  
32KB CACHE

## Data Flash

---

### Features

- 60k cycles EEPROM emulation and data retention for a minimum of five years
- Read-while-write feature supported for EEPROM emulation

### Benefits

- EEPROM emulations eliminate need for external EEPROM
- Alternative to stand-by RAM

#### Data Memory

EEPROM emulation  
192KB DFlash @ 60K  
w/e cycles

## Program Flash

---

### Features

- Two banks offering concurrent read/write/erase
- Dynamic error correction of single-bit errors and detection of double-bit errors (SEC-DED-ECC)
- Margin check control
- Flash read/write protection for each sector with three levels
- Flash read/write protection based on two-tier password

- One-Time Programmable (OTP)
- Tuning protection
- End-to-end protection of Flash data with ECC
- Detection of addressing errors

### Benefits

- Fast end-of-line programming
- Faster access speeds
- Safety and security

#### Program Memory

4MB PFlash  
16KB Boot ROM

## MultiCAN

---

### Features & Benefits

- Full CAN with CAN 2.0B active
- Up to four independent CAN nodes
- Up to 128 message objects
- Programmable acceptance filtering
- Data transfer rate of up to 1Mbit/s individually programmable for each node
- Powerful analysis capability
- FIFO data handling support
- Automatic gateway support
- Flexible interrupt handling

MultiCAN  
(4 Nodes,  
128 MO)

## Direct Memory Access (DMA)

---

### Features

- Up to 16 independent DMA channels
- Programmable priority of DMA sub-blocks on bus interfaces
- Buffer capability for move actions on buses (at least one move per bus is buffered)
- Individually programmable operation modes for each DMA channel
- Full 32-bit addressing capability of each DMA channel
- Programmable data width of DMA transfer/transaction: 8-bit, 16-bit or 32-bit
- Micro link bus interface support
- One register set for each DMA channel
- Flexible interrupt generation
- Memory check unit built in
- DMA controller operates as bus bridge between system peripheral bus and remote peripheral bus (AUDO NG) or to LMB bus (AUDO Future)

### Benefits

- Flexible use for single event or continuous transfer operation
- Flexible interrupt generation
- Maximum flexibility to adapt to customer needs
- Maximum adaptation to application requirements

## General Purpose Timer Array (GPTA)

---

### Features & Benefits

- Very flexible digital input filtering
- Tracking of all kinds of rotating shafts
- Scalable high resolution
- Independent access to time and angle domain
- All types of PWM generation supported\* thanks to Local Timer Cell (LTC) array
- Digital PLL for fine grain angle resolution
- PCP2 is the ideal coprocessor to handle critical short and real-time GPTA interrupt tasks from the GPTA
- Ideal for field test and repair work

## Enhanced Analog-Digital Converter (ADC)

---

### Features & Benefits

- 1–4 synchronizable A/D converters with up to 64 channels
- 8/10/12-bit resolution,  $\pm 2\text{LSB}$  @ 10-bit
- Conversion time down to 1.0 $\mu\text{s}$
- Data reduction pre-processing
- Result accumulation and limit check
- External or internal trigger events and automatic conversion sequencing SSC0

GPTA0

GPTA1

LTCA2

ADC0

ADC1

ADC2

ADC3



## Fast Analog to Digital Converter (FADC)

FADC

### Features & Benefits

- Unique solution for knock detection without external ASICs or dedicated DSP
- Reduced software load for FIR filter thanks to integrated decimation comb filter (e.g. data reduction by a factor of six from 1200 to 200k samples)
- Quick adaptation of overall filter quality to meet application requirements
- Increased ADC accuracy thanks to data reduction filter and by moving averaging filter (e.g. from 10-bit to 11-bit by selected oversampling by a factor of four)

## Asynchronous Serial Channel (ASC)

ASC0

ASC1

### Features & Benefits

- Convenient off-board communication via LIN or K-line
- Full-duplex asynchronous communication up to 5.625Mbit/s
- Half-duplex synchronous communication up to 11.25Mbit/s

## Micro Second Channel (MSC)

MSC0  
LVDS

MSC1  
LVDS

The MSC module sets a new open standard for serial high-speed communication when powering ASIC modules such as multi-switches (for ignition or injection drivers). It transfers command frames, data frames and asynchronous diagnosis feedback from the

device. The MSC module helps designers reduce EMC for high bandrates (up to 45Mbit/s) by supporting low-voltage differential swing (LVDS) for high-speed downstream data and clock rates.

## Multiprocessor Link Interface (MLI)

MLI0

MLI1

### Features & Benefits

- Serial high-speed interface up to MLI/2 (e.g. 45Mbit/s for TC1797) used for inter-processor key Flash communication between the AUDO family members, thus enabling scalable processing power within an application
- Fast interconnection to Infineon companion chips e.g. CIC310 FlexRay controller and CIC751 16-channel ADC

## SENT – New Digital Sensor Interface

---

### Features & Benefits

- SENT stands for Single (falling) Edge Nibble Transmission
- Eight SENT channels work independently in parallel
- Point-to-point digital protocol
- Less complex and lower cost alternative to CAN and LIN digital busses
- Good fit for environments with high noise level (e.g. powertrain) complies with SENT standard (unidirectional) as well as Short PWM Code (SPC) protocol extensions
- SPC enables use of enhanced protocol functionalities such as synchronous, range selection and ID selection
- Data rates of up to 65.8Kbit/s at 3µs tick length and six data nibbles on each channel

## Secure Hardware Extension (SHE)

---

### Features & Benefits

- Fulfills HIS consortium specifications (BMW, Audi, Daimler, Porsche, VW)
- Supports
  - Encoding/decoding of data
  - Secure hash
  - Secure keys stored in secure Flash
  - Prevention of access by hardware or software
- Key programming by OEM
- True random number generator
- Key exchange protocols
- Enables
  - Manipulation protection
  - Authentication
  - Secure boot

## General Purpose Timer 12 (GPT12)

---

### Features & Benefits

- Multifunctional timer structure
  - Timing
  - Event counting
  - Pulse width measurement
  - Pulse generation
  - Frequency multiplication
- Modes
  - Gated timer
  - Counter mode
  - Concatenation of different timers

## Capture/Compare Unit 6 (CCU 6)

### Features & Benefits

- High resolution 16-bit capture and compare unit
- Mainly for AC drive control
- Also supports BLDC control, block commutation and multi-phase machines
- Center-aligned and edge-aligned PWM can be generated

CCU60  
CCU61

CCU62  
CCU63

## FlexRay™ <sup>1)</sup>

### Features & Benefits

- Conformance with FlexRay protocol
- Specification V2.1
- Data rates of up to 10Mbit/s on each channel
- Up to 128 configurable message buffers
- 8KB of message RAM
- ERAY IP
- Supports demand for higher bandwidth (where CAN is bottleneck)
- Enables new vehicle partitioning concepts such as domain control
- Deterministic bus system (supports safety applications)

FlexRay  
(2 Channels)

## Synchronous Serial Channel (SSC)

### Features & Benefits

- Supports rates up to 45Mbit/s
- Communication link for power devices, memories and sensors
- Full-duplex and half-duplex serial synchronous communication
- Hardware support for up to six slave select lines

SSC0

SSC1

SSC2

SSC3

## Enhanced On-Chip Debug Support (OCDS)

TriCore™ V1.6 features enhanced On-Chip Debug Support (OCDS) with program flow and data access breakpoint capabilities. Debuggers can connect using JTAG or a high-speed Device Access Port (DAP) with

only two pins. Flexible cross triggering with internal and external sources and targets helps analyze and debug hard real-time systems.

OCDS L1 Debug  
Interface/JTAG

<sup>1)</sup> FlexRay™ is a trademark of the FlexRay Consortium and used under license.

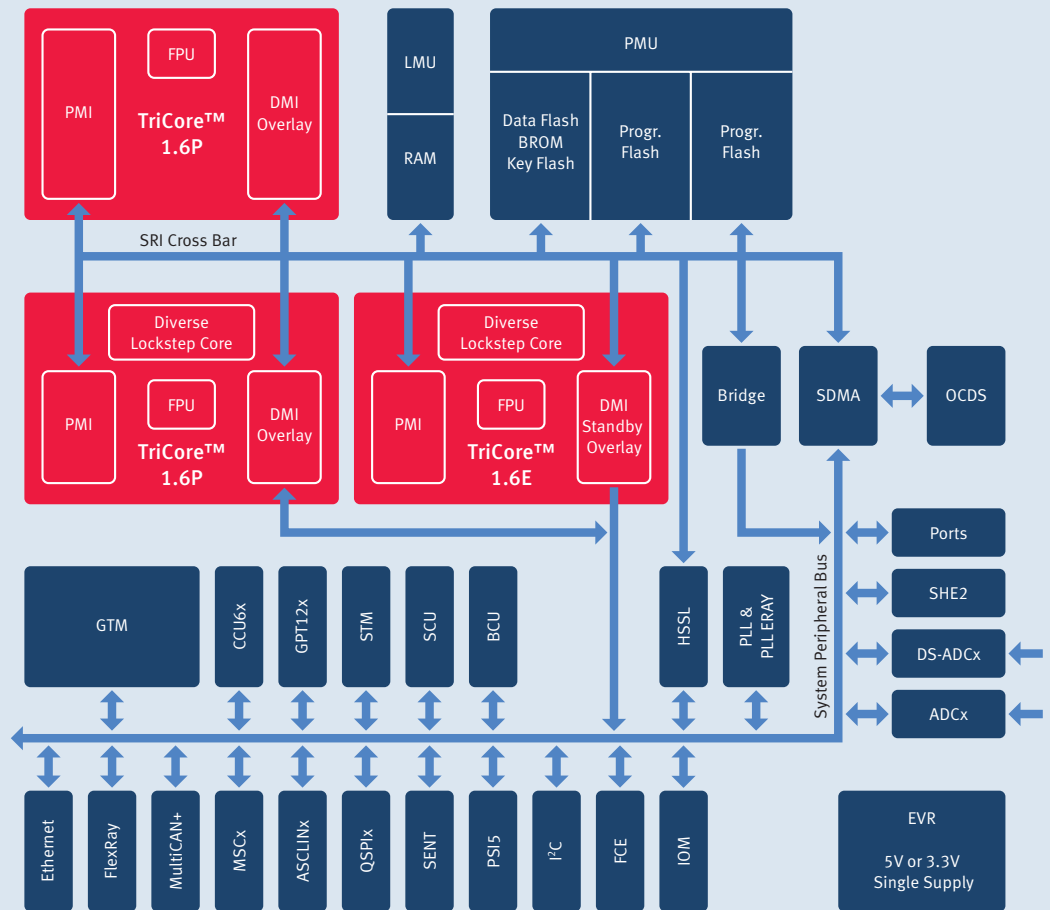

## AURIX™ Family System Architecture

AURIX™ is Infineon's brand new family of microcontrollers serving exactly the needs of the automotive industry in terms of performance and safety. Its innovative multicore architecture, based on up to three independent 32-bit TriCore™ CPUs, has been designed to meet the highest safety standards while significantly increasing performance at the same time.

Using the AURIX™ platform, automotive developers will be able to control powertrain and safety applications with one single MCU platform. Developments using AURIX™ will require less effort to achieve the ASIL-D standard than with a classical Lockstep architecture. Customers wanting to reduce their time-to-market can now cut down their MCU safety development by 30%. By the same token, a performance surplus of 50% up to 100% allows for more functionality and offers a sufficient resource buffer for future requirements, keeping the power consumption on the single-core microcontroller level. While protecting IP, and preventing theft and fraud, AURIX™ provides an already built-in Hardware Security Module.

With its special feature set, AURIX™ is the perfect match for powertrain applications (including hybrid and electrical vehicles) as well as safety applications (such as steering, braking, airbag and advanced driver assistance systems).

## AURIX™ Family Package Scalability

	LQFP-64	LQFP-100	LQFP-144	LQFP-176	LFBGA-292	LPGA-416	LFBGA-516
<b>9x Series</b> up to 8MB up to 300 MHz					TC297 <sup>1)</sup>	TC298	TC299 <sup>1)</sup>
<b>7x Series</b> up to 4MB up to 200MHz				TC275	TC277		
<b>6x Series</b> up to 1.5MB up to 133MHz			TC264	TC265			
<b>4x Series</b> up to 1.5MB		TC243 <sup>2)</sup>	TC244				
<b>3x Series</b> up to 2MB		TC233	TC234				
<b>2x Series</b> up to 1MB		TC223	TC224				
<b>1x Series</b> up to 512KB	TC211	TC213					

↕ Upgrade/Downgrade with pin-compatible packages

- Advanced package technologies deliver the best price/performance ratio
- Customers can choose between different devices in the same pin-compatible package

## TriCore™ Upgrade Paths

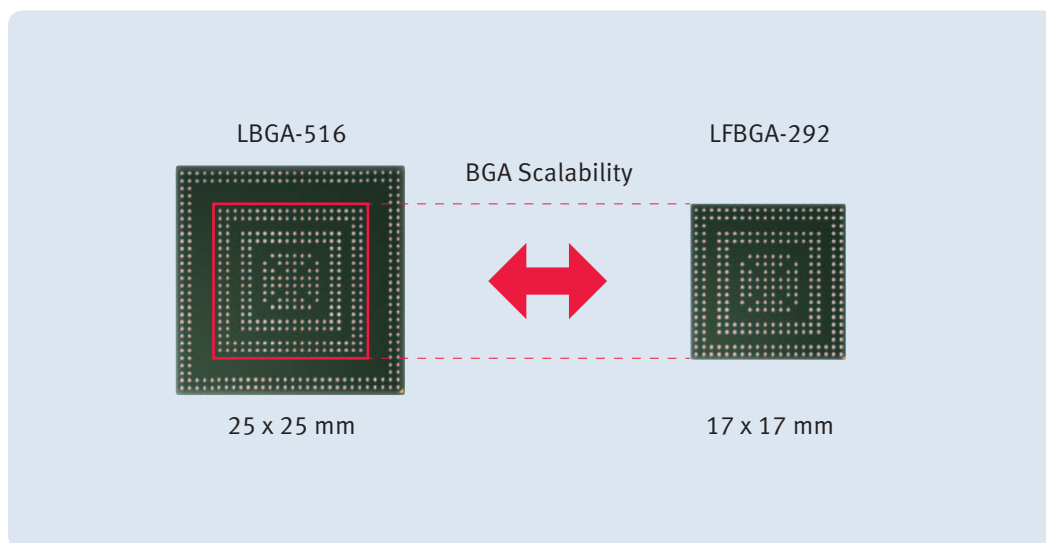

- LFBGA-292 and LPGA-516 are ball compatible so that customers can build one PCB for both packages

1) The LPGA-516 package is a superset of the LFBGA-292.  
Combination PCBs can be designed for I/O and feature upgrades.  
2) The TC24x device is also planned in LQFP-80.



## AURIX™ (HW and SW) Development According to ISO 26262 Process

- Independent Functional Safety Management established at Infineon
- Compliance certificate available
  - SDHB to ISO 26262 Gap Analysis performed by Exida
  - Close-the-gap activities performed by Infineon
  - Exida has issued a compliance certificate (Jan 2012) for Infineon HW and SW development processes for building systems up to ASIL-D

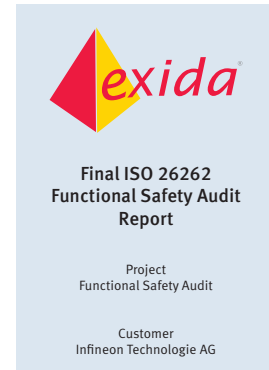

## Infineon® Diverse Lockstep Concept

- Lockstep architecture designed to control and mitigate common cause factors
  - Physical isolation
  - Instruction-level execution diversity: 2-cycle delay
  - Circuit-level design&timing diversity
- Layout-level diversity
- Diversity controlled and verified by state-of-the-art design methods
- Special design of clock&reset networks
- Careful design of lockstep comparator
- Main core and diverse lockstep core run the same software in parallel to detect computational errors
- Like normal locksteps, both cores are physically separated and have a time delay between their execution
- Diverse Lockstep core has been additionally transformed to provide architectural hardware diversity and further reduce common cause failures

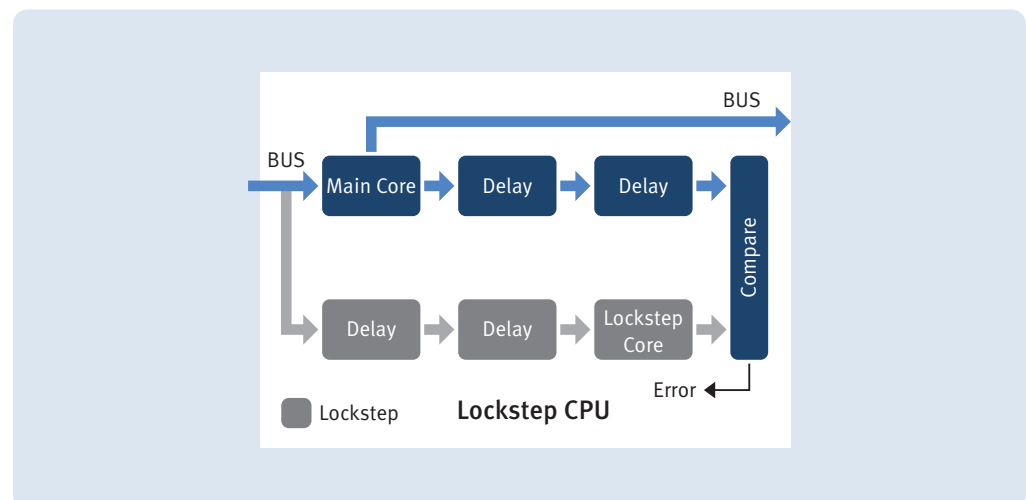

## Multi-AUTOSAR OS Support on One Microcontroller

- AURIX™ provides a memory protection system for each core plus an additional distributed hardware-based resource management system
- Each peripheral and shared SRAM has a resource management unit that works as a local access protection mechanism to allow or deny access
- When combined with the memory protection system, this hardware can be used to prevent selected direct access from certain tasks or cores to peripherals or regions of SRAMs and instead redirect the attempted access to a hypervisor function
- The hypervisor can arbitrate/grant/deny access and therefore provide paravirtualization of mixed-criticality tasks in a unified sub-system architecture with a minimal CPU overhead
- AURIX™ therefore provides the ability to run mixed-criticality software requiring real-time access while still enforcing encapsulation and freedom of interference between cores, even when the cores are not running time- and memory-protected operating systems

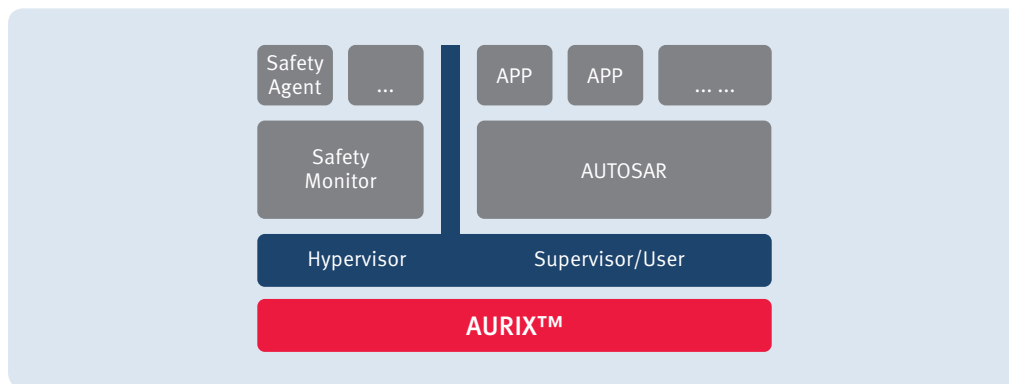

## AURIX™ Protection System Overview

- Hardware Support for Freedom of Interference
  - Between SW components
  - Between HW parts
  - Between HW parts & SW components
- Timing protection

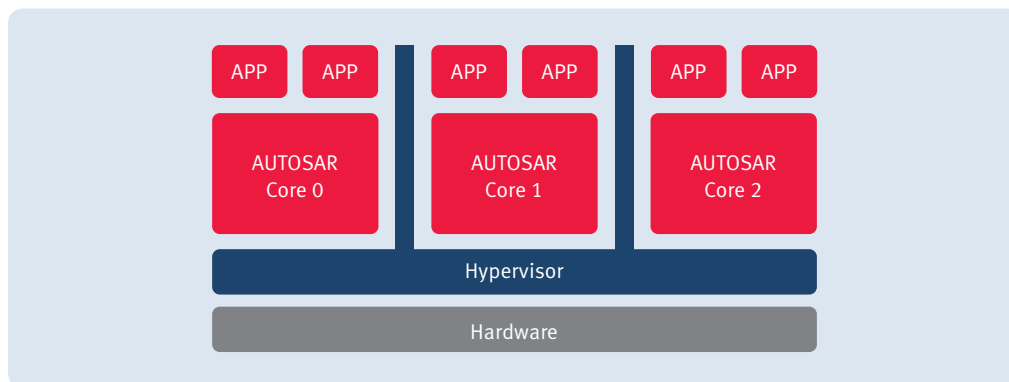

# Embedded Software

## TriCore™ Performance

Real-life application benchmark (software controlling a four-cylinder diesel engine)

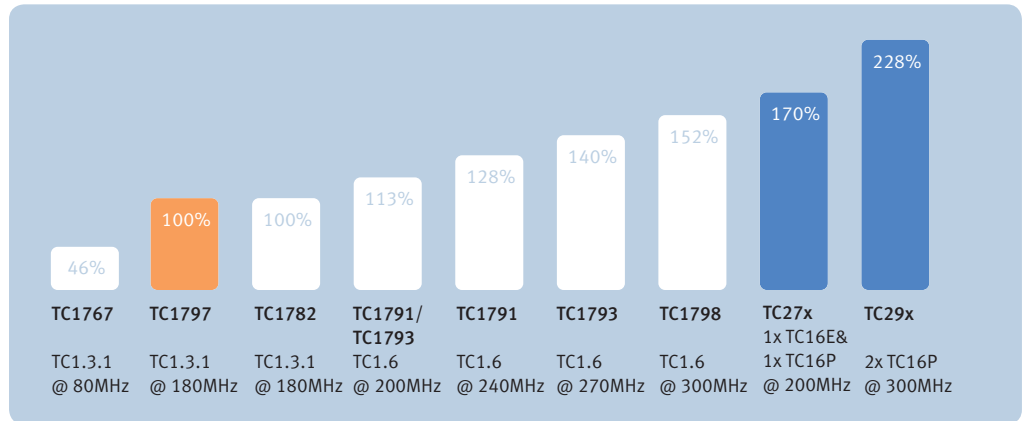

- Assuming multicore performance gain of 1.5 times

## Infineon Software Product Overview

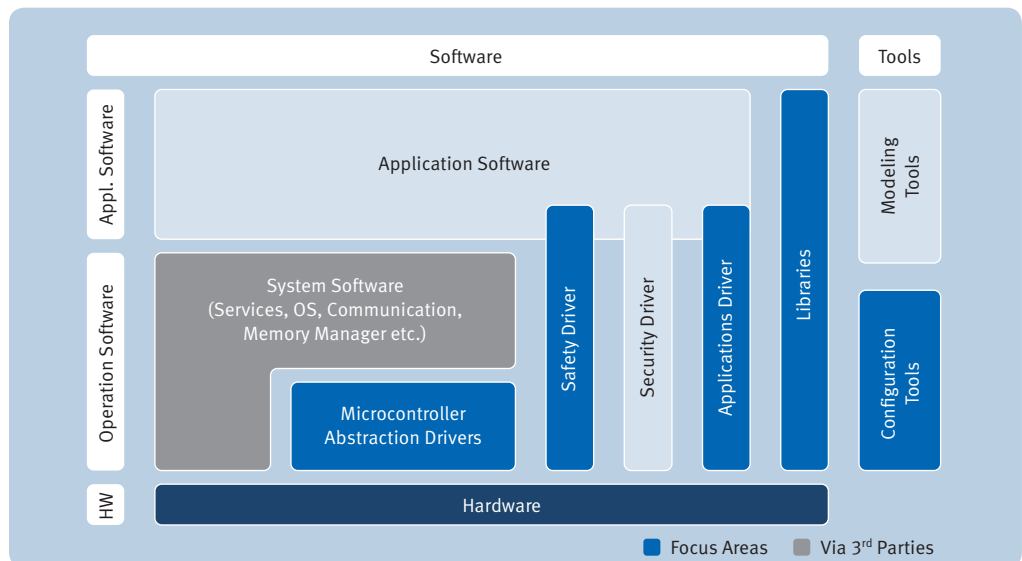

- Microcontroller abstraction drivers
  - AUTOSAR MCAL
  - DAVE™
- Safety driver
  - PRO-SIL™ SafeTcore (AUDO MAX)
  - PRO-SIL™ SafeTlib (AURIX)
- Application drivers
  - DAVE™ Drive (IMM)
  - 3-phase eMotor driver
- System software
- Configuration tool
  - DAVE™
- Libraries
  - TriLib
  - XC2000 DSP library
- Tools
  - MemTool etc.

# Infiniteon AUTOSAR MCAL Drivers

## MC-ISAR Product Overview

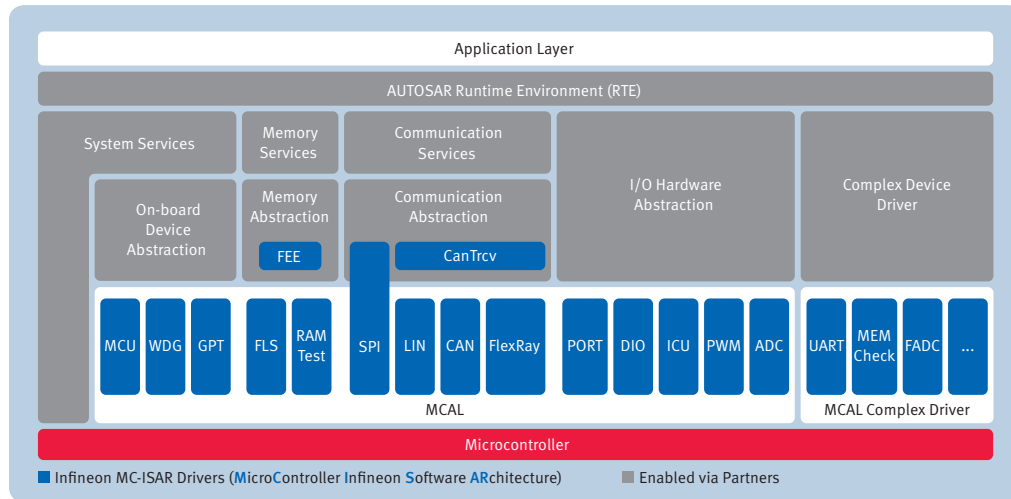

**MC-ISAR**      **MicroController – Infineon Software ARchitecture**  
 MC-ISAR:      MCU, WDG, GPT, SPI, PORT, DIO, ICU, PWM, ADC  
 MC-ISAR COM Basic:      CAN, CanTrcv, LIN  
 MC-ISAR COM Enhanced:      FlexRay, Ethernet  
 MC-ISAR MEM:      FLASH, FEE  
 MC-ISAR MCAL CD:      UART, MEMCheck, FADC, ect. for TriCore™



- Supported AUTOSAR releases and devices
  - V2.0: AUDO NG (TC1796, TC1766)
  - V2.1, V3.0: XC2287, AUDO Future (TC1797, TC1767), AUDO S
  - V3.1, V3.2: XC2000, AUDO MAX
  - V4.03: AUDO MAX
  - V3.2, V4.03: AURIX™
  - ISO 26262 support
- Complex driver for non-standardized modules (for TriCore™)
- CMM L3 process
- AUTOSAR BSW suite via partners: Electrobit, Vector, KPIT
- Delivery packages include: source code, user manual, Tresos configuration tool

## MC-ISAR Product Overview

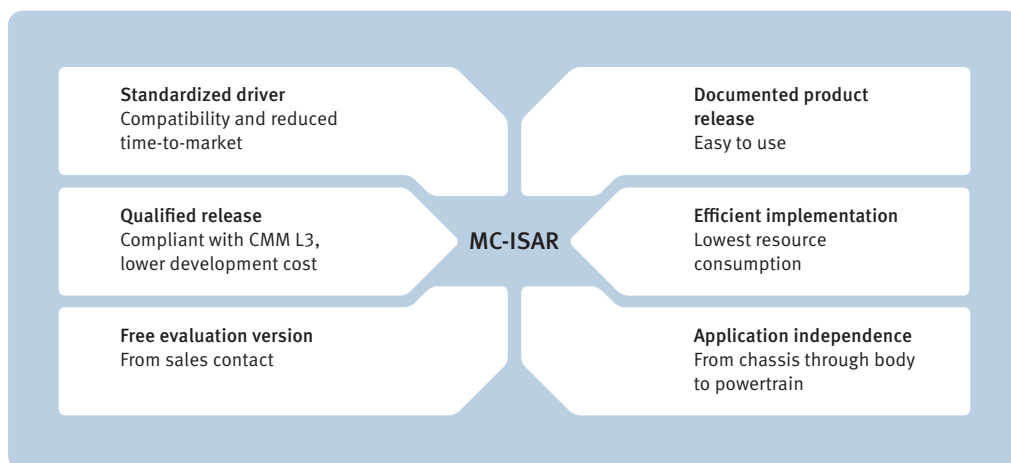

# Embedded Software

## Infineon's MC-ISAR eMotor Driver

---

### 3-Phase Motor Control for Mass Production

Electrical 3-phase motors, such as PMSM (Permanent Magnetic Synchronous Motors) and BLDC (Brushless DC) motors, are used across the automotive application domains (e.g. chassis control, (H)EV inverter, dry double clutch transmission etc.).

3-phase sinusoidal distributed and mechanically displaced windings are the characteristic of PMSM. The rotating magnetic field, activated by sinusoidal and time-displaced current, drives the motor. Three-phase current is switched into the motor windings via MOSFETs. The Field Oriented Control (FOC) algorithm generates the PWM pattern needed for the current control. The rotor position and current are continuously sensed. The high-performance microcontroller plays the key role in the FOC algorithm, allowing higher accuracy, safer execution and improved efficiency for motor control.

The MC-ISAR eMotor driver collects the common feature of current and torque control, acting as a perfect solution for motor drive applications. Position and speed control can be achieved on an application-specific basis, supporting multiple position acquisition modes and satisfying different customer needs.

#### Feature Highlights

- Control PMSM motors via Field Oriented Control (FOC), including Space Vector Modulation SVM
- Control BLDC motors via Block Communication (BC)
- Mixed control of FOC / BC motors
- Integrated with AUTOSAR drivers
- Supports safety applications

#### Sensors in FOC Mode

- Hall sensors/Incremental encoder
- Direct resolver mode (without resolver IC)
- Resolver mode (with resolver IC)
- Sensorless FOC
- Current Measurement: 3 phases, 2-phase parallel and sequential, DC link sequential

#### Sensors in BC Mode

- Hall sensors
- Sensorless via back EMF
- Current Measurement: DC link single

#### MC-ISAR eMotor Benefits:

- Developed for mass production, off-the-shelf implementation
- Limited software outlay
- Direct resolver mode (no external resolver IC), reduced system cost
- Compliant to ISO 26262 process and CMM level 3
- Seamless configuration under the same configuration tool for AUTOSAR MCAL driver
- Easy to use



### FOC Mode

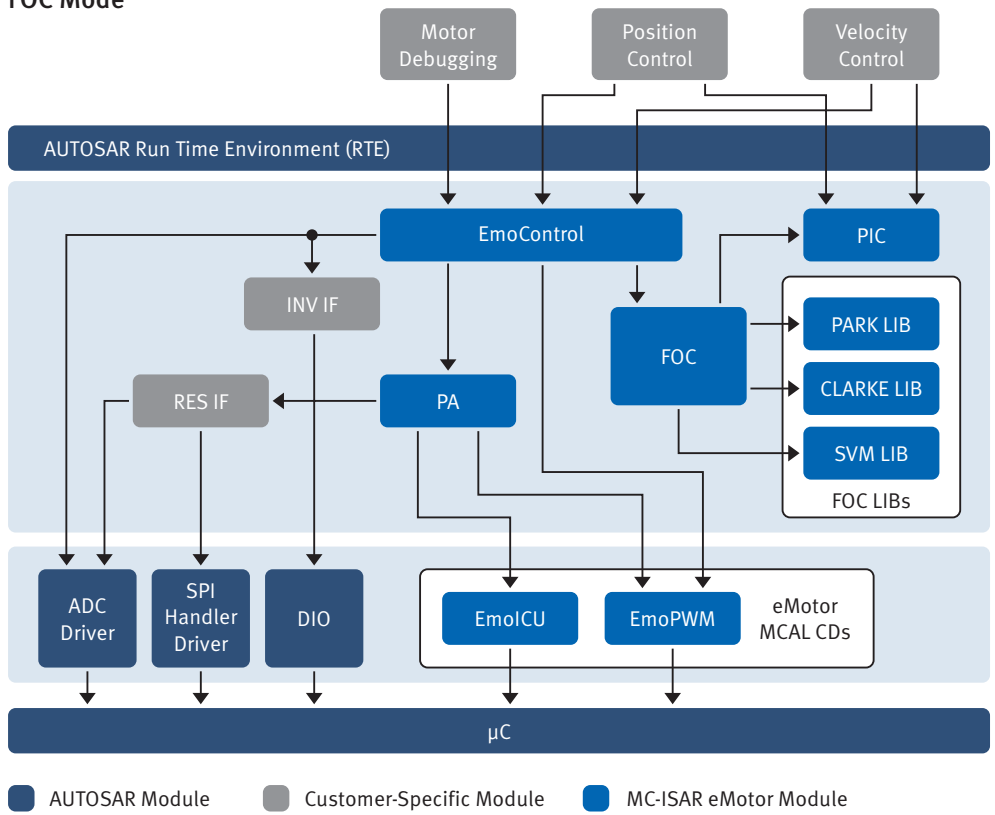

### BC Mode

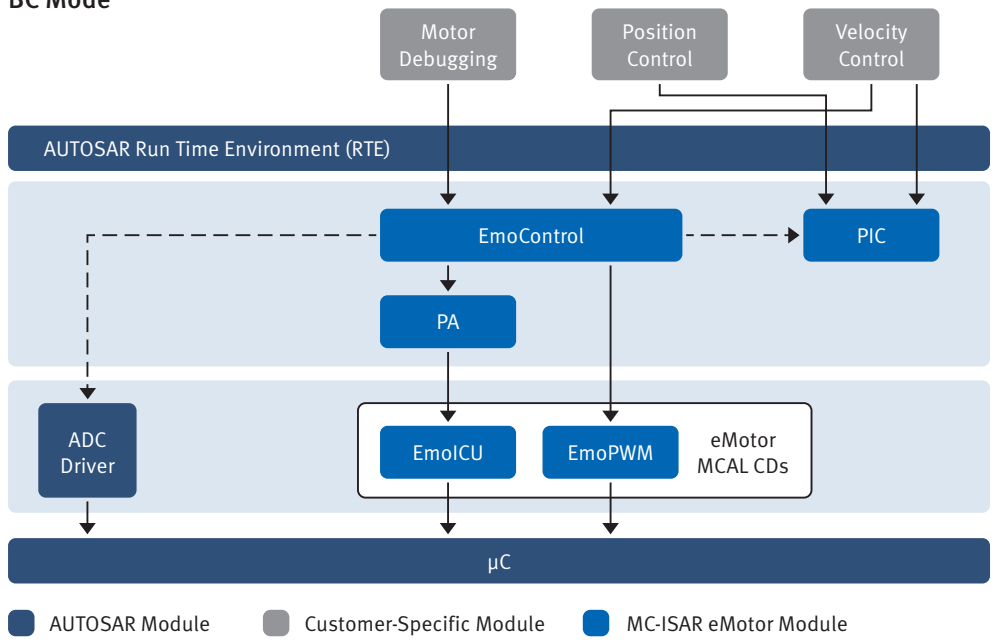

# Development Support

## Emulation Device

---

- Emulation Devices (ED) are a very powerful solution for calibration, measurement, rapid prototyping and debugging
- Emulation logic and RAM is added next to the unchanged Production Device (PD) part on the same chip
- Cost-optimized PD, feature rich ED
- Same package for ED and PD and minimum or no additional external circuitry allows highly cost-optimized ECU design
- Proven solution with broad tool support by leading automotive and debug tool vendors



PD and ED in same package

### AURIX™ Highlights

- Up to 2Mbyte RAM for calibration with same access speed as on-chip flash
- Cold start access via the regular two pin DAP interface when the ECU is unpowered
- Automotive measurement bandwidth (XCP) 15/30Mbyte/s via regular 2/3 pin DAP interface

## Trace and Measurement

---

Today's vehicles are designed to meet rising market demands for engine performance, engine responsiveness, torque, drivability, fuel economy and emissions. Infineon's proven Multicore Debug Solution (MCDS) enables manufacturers to design and optimize features to support these automotive trends.

### Multicore Debug Solution (MCDS)

#### Key Features

- Tracing of CPUs, busses, performance events and peripheral internal states
- Real-time, cycle-accurate and in parallel
- Up to 1Mbyte on-chip trace RAM (40Gbit/s bandwidth)
- Very powerful trigger capabilities
- No additional pins needed beside the DAP interface
- New Compact Function Trace (CFT) mode for continuous program trace via DAP
- New fine grained data trace qualification for automotive measurement

## DAVE™ – Digital Application Virtual Engineer

DAVE™ is a tool that helps engineers program Infineon microcontrollers. It provides intelligent wizards that configure chips to specific requirements and automatically generate C-code with appropriate driver functions for all on-chip peripherals and interrupt controls.

DAVE™ interacts directly with the IDEs from leading tool suppliers and with Infineon's free toolchain DAVE™ Bench.

The DAVE™ mother system and DIP file for the microcontroller in question are needed to use DAVE™.

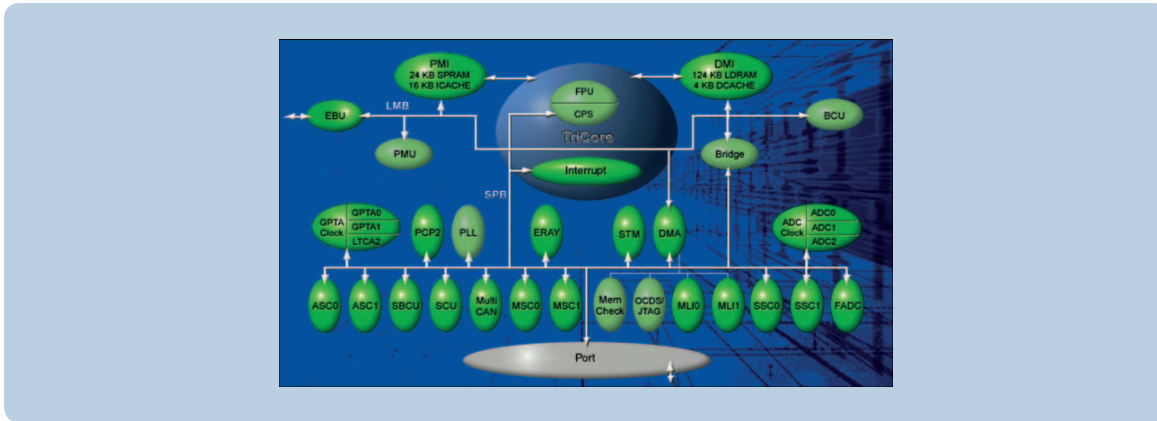

### Key Features

- DAVE™ generates initialization code for Infineon microcontrollers
- DAVE™ displays all available peripherals in a block diagram at the start
- Click on a peripheral to define its functionality

### Starter Kits

Infineon AUDO family starter kits are powerful evaluation systems that enable evaluation and development well before the target hardware is available. They offer a solid platform for both hardware and software engineers to evaluate and prototype designs that are closely aligned with their final applications.

#### Our Starter Kits include

- Full-Featured Evaluation Board
- USB cable
- Easy connectivity to all peripheral modules
- Extension Board
- Development tools for evaluation such as compilers, debuggers and DAVE™
- Technical documentation – user manuals, architecture manuals, application notes, data sheets, board documentation



Further information for TriCore™ Starter Kits: <http://ehitex.com/starter-kits/for-tricore>

# TriCore™ Tool Partners

## Embedded Software



## Simulation/Virtual Prototyping



## Integrated Compiler Environments



## Auto Code Generation Tools



## Timing/Scheduling Analysis



## Operating Systems



## Emulators/Debugger Development Systems



## Data Measurement/Calibration/Rapid Prototyping



## Programmer/Flash Tools



## Software Verification



## Training/Services



## Free Tooling

Free TriCore™ Entry Tool Chain [Compiler/Debugger/Eclipse IDE]



## Important Links/Contact

### **Local**

Field application

Engineers via Infineon, distributors and sales representatives

[www.infineon.com/sales](http://www.infineon.com/sales)

**Regional** Application engineering teams

Detroit, Munich, Shanghai, Singapore and Tokyo

**Global** Microcontroller R&D teams

Service center: [www.infineon.com/service](http://www.infineon.com/service)

Technical training: [www.infineon.com/mc-training](http://www.infineon.com/mc-training)

## Ask Infineon. Get connected with the answers.

Where you need it. When you need it.

Infineon offers its toll-free 0800/4001 service hotline as one central number, available 24/7 in English, Mandarin and German.

Our global connection service goes way beyond standard switchboard services by offering qualified support on the phone. Call us!

- Germany ..... 0800 951 951 951 (German/English)
- China, mainland ..... 4001 200 951 (Mandarin/English)
- India ..... 000 800 4402 951 (English)
- USA ..... 1-866 951 9519 (English/German)
- Other countries ..... 00\* 800 951 951 951 (English/German)
- Direct access ..... +49 89 234-0 (interconnection fee, German/English)

\* Please note: Some countries may require you to dial a code other than "00" to access this international number, please visit [www.infineon.com/service](http://www.infineon.com/service) for your country!

## Where to Buy

### Infineon Distribution Partners and Sales Offices

Please use our location finder to get in contact with your nearest Infineon distributor or sales office.

[www.infineon.com/WhereToBuy](http://www.infineon.com/WhereToBuy)

Infineon Technologies – innovative semiconductor solutions for energy efficiency, mobility and security.

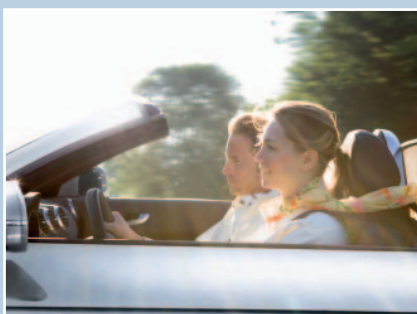

Published by  
Infineon Technologies AG  
85579 Neubiberg, Germany

© 2012 Infineon Technologies AG.  
All Rights Reserved.

Visit us:  
[www.infineon.com](http://www.infineon.com)

Order Number: B158-H9282-G3-X-7600  
Date: 08 / 2012

#### ATTENTION PLEASE!

The information given in this document shall in no event be regarded as a guarantee of conditions or characteristics ("Beschaffungsgarantie"). With respect to any examples or hints given herein, any typical values stated herein and/or any information regarding the application of the device, Infineon Technologies hereby disclaims any and all warranties and liabilities of any kind, including without limitation warranties of non-infringement of intellectual property rights of any third party.

#### INFORMATION

For further information on technology, delivery terms and conditions and prices please contact your nearest Infineon Technologies Office ([www.infineon.com](http://www.infineon.com)).

#### WARNINGS

Due to technical requirements components may contain dangerous substances. For information on the types in question please contact your nearest Infineon Technologies Office. Infineon Technologies Components may only be used in life-support devices or systems with the express written approval of Infineon Technologies, if a failure of such components can reasonably be expected to cause the failure of that life-support device or system, or to affect the safety or effectiveness of that device or system. Life support devices or systems are intended to be implanted in the human body, or to support and/or maintain and sustain and/or protect human life. If they fail, it is reasonable to assume that the health of the user or other persons may be endangered.





# Feature Overview TriCore™ Family

## TriCore™ Microcontroller for Automotive Applications

Product Type	Max Clock Frequency [MHz]	Program Memory [KByte]	SRAM (incl. Cache) [KByte]	Co-Processor <sup>1)</sup>	Digital I/O Lines	Number of ADC Channels	Timed IO Channels (PWM, CAPCOM, GPTA)	External Bus Interface	CAN Nodes	Communication Interfaces <sup>2)</sup>	Temperature Ranges <sup>3)</sup>	Packages	Additional Features/Remarks <sup>4)</sup>
<b>AUDO – Next Generation Family</b>													
TC1766	80	1500	88	FPU, PCP	81	32	48	no	2	2xASC, 2xSSC, MSC, 2xMLI	K	PG-LQFP-176	
TC1796	150	2000	192	FPU, PCP	123	44	126	yes	4	2xASC, 2xSSC, 2xMSC, 2xMLI	K	PG-BGA-416	
<b>AUDO – Future Family</b>													
TC1736	80	1000	48	FPU	70	24	53	no	2	2xASC, 2xSSC, MSC, MLI	K	PG-LQFP-144	
TC1767	133	2000	104	FPU, PCP	88	36	80	no	2	2xASC, 2xSSC, MSC, MLI	K	PG-LQFP-176	
TC1797	180	4000	176	FPU, PCP	221	48	118	yes	4	2xASC, 2xSSC, 2xMSC, 2xMLI, 2xFlexRay	K	PG-BGA-416	
<b>AUDO MAX – Family</b>													
TC1724	133	1500	152	FPU, PCP	89	28	77	no	3	2xASC, 4xSSC, MSC, MLI	K	PG-LQFP-144	EVR
TC1728	133	1500	152	FPU, PCP	113	36	94	no	3	2xASC, 4xSSC, MSC, MLI	K	PG-LQFP-176	EVR
TC1782	180	2500	176	FPU/PCP	88	36	80	no	3	2xASC, 3xSSC, MSC, MLI, FlexRay	K	PG-LQFP-176	
TC1784	180	2500	176	FPU/PCP	141	36	122	yes	3	2xASC, 3xSSC, MSC, MLI, FlexRay	K	PG-LFBGA-292	
TC1791	240	4000	288	FPU/PCP	130	48	100	no	4	2xASC, 4xSSC, 2xMSC, 2xMLI, 8xSENT, FlexRay	K	PG-LFBGA-292	
TC1793	270	4000	288	FPU/PCP	221	44	112	yes	4	2xASC, 4xSSC, 2xMSC, 2xMLI, 8xSENT, FlexRay	K	PG-LBGA-416	
TC1798	300	4000	288	FPU/PCP	238	72	138	yes	4	2xASC, 4xSSC, 2xMSC, 2xMLI, 8xSENT, FlexRay	K	PG-BGA-516	
<b>AURIX™ – Family</b>													
TC275T	200	4000	472	FPU	112	60 / 6 DS	110	no	4	4xASCLIN, 4xQSPI, 2xMSC, HSSL, I <sup>2</sup> C, 10xSENT, 3xPSI5, FlexRay, Ethernet	K	PG-LQFP-176	EVR
TC277T	200	4000	472	FPU	151	60 / 6 DS	134	no	4	4xASCLIN, 4xQSPI, 2xMSC, HSSL, I <sup>2</sup> C, 10xSENT, 3xPSI5, FlexRay, Ethernet	K	PG-LFBGA-292	EVR



# Feature Overview TriCore™ Family

## TriCore™ Microcontroller for Industrial Applications

Product Type	Max Clock Frequency [MHz]	Program Memory [KByte]	SRAM (incl. Cache) [KByte]	Co-Processor <sup>1)</sup>	Digital I/O Lines	Number of ADC Channels	Timed IO Channels (PWM, CAPCOM, GPTA)	External Bus Interface	CAN Nodes	Communication Interfaces <sup>2)</sup>	Temperature Ranges <sup>3)</sup>	Packages	Additional Features/Remarks <sup>4)</sup>
<b>TC1x Family</b>													
TC1167	133	1000	104	FPU, PCP	88	36	80	no	2	2xASC, 2xSSC, MSC, MLI	F	PG-LQFP-176	
TC1197	180	4000	176	FPU, PCP	221	48	118	yes	4	2xASC, 2xSSC, 2xMSC, 2xMLI	K	PG-BGA-416	
<b>AUDO MAX – Family</b>													
TC1724	133	1500	152	FPU, PCP	89	28	77	no	3	2xASC, 4xSSC, MSC, MLI	K	PG-LQFP-144	EVR
TC1728	133	1500	152	FPU, PCP	113	36	94	no	3	2xASC, 4xSSC, MSC, MLI	K	PG-LQFP-176	EVR
TC1782	180	2500	176	FPU, PCP	88	36	80	no	3	2xASC, 4xSSC, MSC, MLI	K	PG-LQFP-176	
TC1784	180	2500	176	FPU, PCP	141	36	122	yes	3	2xASC, 4xSSC, MSC, MLI	K	PG-LFBGA-292	
TC1791	240	3000	288	FPU, PCP	130	48	100	no	4	2xASC, 4xSSC, 2xMSC, 2xMLI, 8xSENT	K	PG-LFBGA-292	
TC1793	270	4000	288	FPU, PCP	221	44	112	yes	4	2xASC, 4xSSC, 2xMSC, 2xMLI, 8xSENT	K	PG-BGA-416	
TC1798	300	4000	288	FPU, PCP	238	72	138	yes	4	2xASC, 4xSSC, 2xMSC, 2xMLI, 8xSENT	K	PG-BGA-516	

1) MAC = Multiply-Accumulate-Unit (DSP), FPU = Floating Point Unit, PCP = Peripheral Control Processor

2) I<sup>2</sup>C = Inter-Integrated Circuit, USART = Universal Synchronous Asynchronous Receiver Transmitter, UART = Universal Asynchronous Receiver Transmitter, SSC = Synchronous Serial Channel, ASC = Asynchronous Serial Channel, MLI = Micro Link Interface, MSC = Micro Second Channel, LIN = Local Interconnect Network

3) Ambient Temperature Range: B = 0 ... 70°C, F = -40 ... 85°C, X = -40 ... 105°C, K = -40 ... 125°C, A = -40 ... 140°C, L = -40 ... 150°C, H = -40 ... 110°C

4) ROM = Read Only Memory, EVR = Embedded Voltage Regulator

Published by  
Infineon Technologies AG  
85579 Neubiberg, Germany

© 2012 Infineon Technologies AG.  
All Rights Reserved.

Visit us:  
[www.infineon.com](http://www.infineon.com)

Date: 08 / 2012

### ATTENTION PLEASE!

The information given in this document shall in no event be regarded as a guarantee of conditions or characteristics ("Beschaffenheitsgarantie"). With respect to any examples or hints given herein, any typical values stated herein and/or any information regarding the application of the device, Infineon Technologies hereby disclaims any and all warranties and liabilities of any kind, including without limitation warranties of non-infringement of intellectual property rights of any third party.

### INFORMATION

For further information on technology, delivery terms and conditions and prices please contact your nearest Infineon Technologies Office ([www.infineon.com](http://www.infineon.com)).

### WARNINGS

Due to technical requirements components may contain dangerous substances. For information on the types in question please contact your nearest Infineon Technologies Office. Infineon Technologies Components may only be used in life-support devices or systems with the express written approval of Infineon Technologies, if a failure of such components can reasonably be expected to cause the failure of that life-support device or system, or to affect the safety or effectiveness of that device or system. Life support devices or systems are intended to be implanted in the human body, or to support and/or maintain and sustain and/or protect human life. If they fail, it is reasonable to assume that the health of the user or other persons may be endangered.



**Стандарт  
Электрон  
Связь**

Мы молодая и активно развивающаяся компания в области поставок электронных компонентов. Мы поставляем электронные компоненты отечественного и импортного производства напрямую от производителей и с крупнейших складов мира.

Благодаря сотрудничеству с мировыми поставщиками мы осуществляем комплексные и плановые поставки широчайшего спектра электронных компонентов.

Собственная эффективная логистика и склад в обеспечивает надежную поставку продукции в точно указанные сроки по всей России.

Мы осуществляем техническую поддержку нашим клиентам и предпродажную проверку качества продукции. На все поставляемые продукты мы предоставляем гарантию .

Осуществляем поставки продукции под контролем ВП МО РФ на предприятия военно-промышленного комплекса России , а также работаем в рамках 275 ФЗ с открытием отдельных счетов в уполномоченном банке. Система менеджмента качества компании соответствует требованиям ГОСТ ISO 9001.

Минимальные сроки поставки, гибкие цены, неограниченный ассортимент и индивидуальный подход к клиентам являются основой для выстраивания долгосрочного и эффективного сотрудничества с предприятиями радиоэлектронной промышленности, предприятиями ВПК и научно-исследовательскими институтами России.

С нами вы становитесь еще успешнее!

**Наши контакты:**

**Телефон:** +7 812 627 14 35

**Электронная почта:** [sales@st-electron.ru](mailto:sales@st-electron.ru)

**Адрес:** 198099, Санкт-Петербург,  
Промышленная ул, дом № 19, литера Н,  
помещение 100-Н Офис 331