

LOW-INPUT-VOLTAGE CURRENT-LIMITED LOAD SWITCHES WITH SHUT OFF AND AUTO-RESTART FEATURE

Check for Samples: [TPS22941](#) [TPS22942](#) [TPS22943](#) [TPS22944](#) [TPS22945](#)

FEATURES

- Input Voltage Range: 1.62 V to 5.5 V
- Low ON resistance
 - $r_{ON} = 0.4 \Omega$ at $V_{IN} = 5.5 V$
 - $r_{ON} = 0.5 \Omega$ at $V_{IN} = 3.3 V$
 - $r_{ON} = 0.6 \Omega$ at $V_{IN} = 2.5 V$
 - $r_{ON} = 0.8 \Omega$ at $V_{IN} = 1.8 V$
- Minimum Current Limit: 40 mA or 100 mA
- Undervoltage Lockout
- Thermal Shutdown
- Shutdown Current < 1 μA
- Fast Current Limit Response Time
- Fault Blanking
- Auto Restart
- 1.8-V Compatible Control Input Thresholds
- ESD Performance Tested Per JESD 22
 - 4000-V Human-Body Model (A114-B, Class II)
 - 1000-V Charged-Device Model (C101)
- Tiny SC-70 (DCK) Package

APPLICATIONS

- Low-Current Sensor Protection
- HDMI Connector Protection
- Notebooks
- PDAs
- GPS Devices
- MP3 Players
- Peripheral Ports

DESCRIPTION

The TPS2294x load switches provide protection to systems and loads in high-current conditions. The devices contain a 400-m Ω current-limited P-channel MOSFET that can operate over an input voltage range of 1.62 V to 5.5 V. Current is prevented from flowing when the MOSFET is off. The switch is controlled by an on/off input (ON), which is capable of interfacing directly with low-voltage control signals. The TPS2294x includes thermal shutdown protection that prevents damage to the device when a continuous over-current condition causes excessive heating by turning off the switch.

When the switch current reaches the maximum limit, the TPS22941/2/3/4/5 operates in a constant-current mode to prohibit excessive currents from causing damage. TPS22941/3 has a current limit of 40 mA and TPS22942/4/5 has a current limit of 100 mA.

For the TPS22941/2/5, if the constant current condition still persists after 10ms, these parts shut off the switch and pull the fault signal pin (OC) low. The TPS22941/2/5, have an auto-restart feature that turns the switch on again after 80 ms if the ON pin is still active. A current limit condition on the TPS22943 and on the TPS22944 immediately pull the fault signal pin low (OC pin) and the part remains in the constant-current mode until the switch current falls below the current limit.

The TPS2294x is available in a SC70-5 (DCK) package. It is characterized for operation over the free-air temperature range of $-40^{\circ}C$ to $85^{\circ}C$.

Table 1. Feature List

DEVICE	MINIMUM CURRENT LIMIT (mA)	CURRENT LIMIT BLANKING TIME (ms)	AUTO-RESTART TIME (ms)	ON PIN ACTIVITY
TPS22941	40	10	80	Active LOW
TPS22942	100	10	80	Active LOW
TPS22943	40	0	N/A	Active HIGH
TPS22944	100	0	N/A	Active HIGH
TPS22945	100	10	80	Active HIGH



Please be aware that an important notice concerning availability, standard warranty, and use in critical applications of Texas Instruments semiconductor products and disclaimers thereto appears at the end of this data sheet.

ORDERING INFORMATION⁽¹⁾

T _A	PACKAGE ⁽²⁾		ORDERABLE PART NUMBER	TOP-SIDE MARKING ⁽³⁾
-40°C to 85°C	SOT (SC70) – DCK	Tape and reel	TPS22941DCKR	4A_
			TPS22942DCKR	4B_
			TPS22943DCKR	4C_
			TPS22944DCKR	4D_
			TPS22945DCKR	4E_

- (1) For the most current package and ordering information, see the Package Option Addendum at the end of this document, or see the TI web site at www.ti.com.
- (2) Package drawings, thermal data, and symbolization are available at www.ti.com/packaging.
- (3) The actual top-side marking has one additional character that designates the wafer fab/assembly site.

BLOCK DIAGRAM

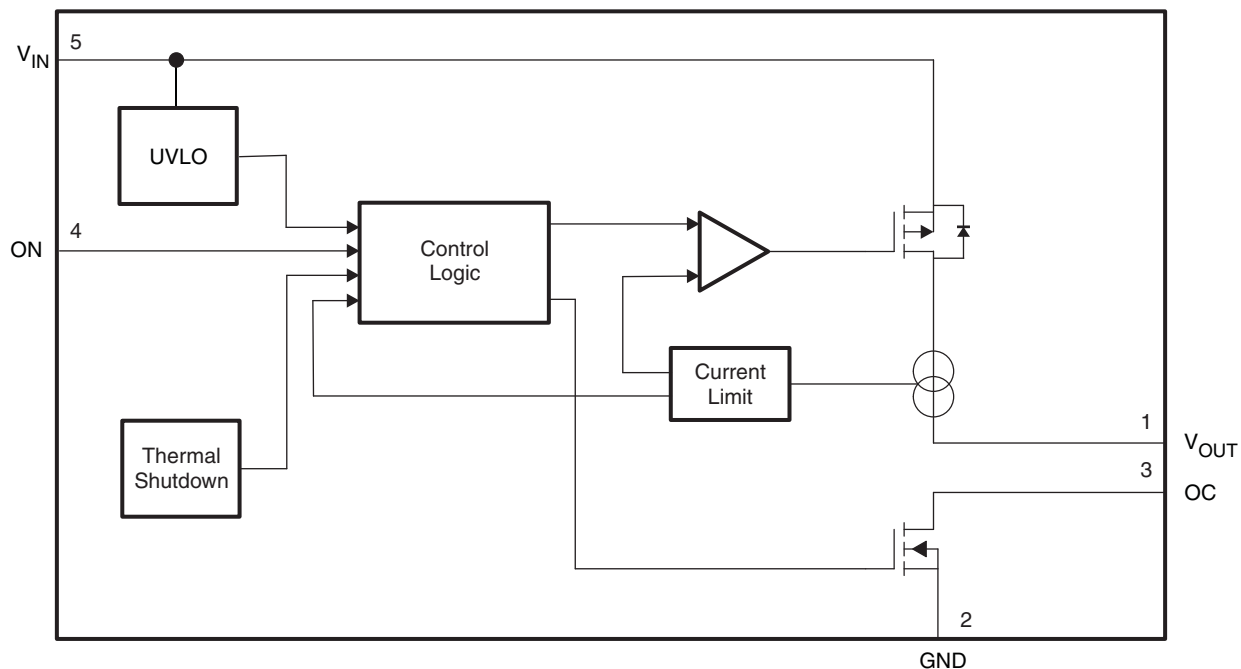

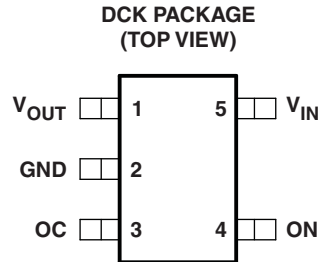
TERMINAL FUNCTIONS

TERMINAL		TYPE	DESCRIPTION
SOT (DCK) PIN NO.	NAME		
1	V_{OUT}	O	Switch output: output of the power switch
2	GND	–	Ground
3	OC	O	Over current output flag: active LOW, open drain output that indicates an over current, supply under voltage, or over temperature state.
4	ON	I	ON control input
5	V_{IN}	I	Supply input: input to the power switch and the supply voltage for the IC
–	DNU	–	Do not use

ABSOLUTE MAXIMUM RATINGS⁽¹⁾

			MIN	MAX	UNIT
V _I	Input voltage range	V _{IN} , V _{OUT} , ON	-0.3	6	V
T _J	Operating junction temperature range		-40	125	°C
T _{stg}	Storage temperature range		-65	150	°C
ESD	Electrostatic discharge protection	Human-Body Model (HBM)		4	kV
		Charged-Device Model (CDM)		1	

(1) Stresses beyond those listed under absolute maximum ratings may cause permanent damage to the device. These are stress ratings only, and functional operation of the device at these or any other conditions beyond those indicated under *Recommended Operating Conditions* is not implied. Exposure to absolute-maximum-rated conditions for extended periods may affect device reliability.

THERMAL IMPEDANCE RATINGS

			UNIT
θ _{JA}	Package thermal impedance ⁽¹⁾	DCK package	259 °C/W

(1) The package thermal impedance is calculated in accordance with JESD 51-7.

RECOMMENDED OPERATING CONDITIONS

		MIN	MAX	UNIT
V _{IN}	Input voltage	1.62	5.5	V
V _{OUT}	Output voltage		V _{IN}	
T _A	Ambient free-air temperature	-40	85	°C

ELECTRICAL CHARACTERISTICS

V_{IN} = 1.62 V to 5.5 V, T_A = -40°C to 85°C (unless otherwise noted)

PARAMETER	TEST CONDITIONS	T _A	MIN	TYP ⁽¹⁾	MAX	UNIT	
I _{IN}	Quiescent current I _{OUT} = 0 mA, V _{IN} = 1.62 V to 5.5 V	Full		40	80	µA	
I _{IN(OFF)}	OFF-State supply current V _{ON} = 0 V (TPS22943/4/5) or V _{ON} = V _{IN} (TPS22941/2) V _{IN} = 3.6 V, V _{OUT} open	Full			1	µA	
I _{OUT(LEAKAGE)}	OFF-State switch current V _{ON} = 0 V (TPS22943/4/5) or V _{ON} = V _{IN} (TPS22941/2) V _{IN} = 3.6 V, V _{OUT} short to GND	Full			1	µA	
r _{ON}	ON-state resistance I _{OUT} = 20 mA	25°C		0.4	0.5	Ω	
		Full			0.6		
		25°C		0.5	0.6		
		Full			0.7		
		25°C		0.6	0.7		
		Full			0.8		
		25°C		0.8	0.9		
		Full			1.1		
I _{ON}	ON input leakage current V _{ON} = V _{IN} or GND	Full			1	µA	
I _{LIM}	Current limit V _{IN} = 3.3 V, V _{OUT} = 3 V	TPS22941/3		40	65	80	mA
		TPS22942/4/5		100	150	200	
Thermal shutdown	Shutdown threshold	Full		140		°C	
	Return from shutdown			130			
	Hysteresis			10			

(1) Typical values are at V_{IN} = 3.3 V and T_A = 25°C.

ELECTRICAL CHARACTERISTICS (continued)
 $V_{IN} = 1.62\text{ V to }5.5\text{ V}$, $T_A = -40^\circ\text{C to }85^\circ\text{C}$ (unless otherwise noted)

PARAMETER		TEST CONDITIONS	T_A	MIN	TYP ⁽¹⁾	MAX	UNIT
UVLO	Undervoltage shutdown	V_{IN} increasing	Full	1.32	1.42	1.52	V
	Undervoltage shutdown hysteresis		Full	45			mV
Control Output (OC)							
Vol	OC output logic low voltage	$V_{IN} = 5\text{ V}$, $I_{SINK} = 10\text{ mA}$	Full	0.1		0.2	V
		$V_{IN} = 1.8\text{ V}$, $I_{SINK} = 10\text{ mA}$		0.1		0.3	
IoZ	OC output high leakage current voltage	$V_{IN} = 5\text{ V}$, Switch ON	Full			0.5	μA
Control Input (ON)							
Vih	ON high-level input voltage	$V_{IN} = 1.8\text{ V}$	Full	1.1			V
		$V_{IN} = 2.5\text{ V}$	Full	1.3			V
		$V_{IN} = 3.3\text{ V}$	Full	1.4			V
		$V_{IN} = 5.5\text{ V}$	Full	1.7			V
Vil	ON low-level input voltage	$V_{IN} = 1.8\text{ V}$	Full			0.5	V
		$V_{IN} = 2.5\text{ V}$	Full			0.7	V
		$V_{IN} = 3.3\text{ V}$	Full			0.8	V
		$V_{IN} = 5.5\text{ V}$	Full			0.9	V
li	ON high-level input leakage current	$V_{IN} = 1.8\text{ V to }5\text{ V}$, Switch ON	Full			1	μA

SWITCHING CHARACTERISTICS
 $V_{IN} = 3.3\text{ V}$, $R_L = 500\ \Omega$, $C_L = 0.1\ \mu\text{F}$, $T_A = 25^\circ\text{C}$ (unless otherwise noted)

PARAMETER		TEST CONDITIONS	MIN	TYP	MAX	UNIT
t_{ON}	Turn-ON time	$R_L = 500\ \Omega$, $C_L = 0.1\ \mu\text{F}$	60			μs
t_{OFF}	Turn-OFF time	$R_L = 500\ \Omega$, $C_L = 0.1\ \mu\text{F}$	30			μs
t_r	V_{OUT} rise time	$R_L = 500\ \Omega$, $C_L = 0.1\ \mu\text{F}$	10			μs
t_f	V_{OUT} fall time	$R_L = 500\ \Omega$, $C_L = 0.1\ \mu\text{F}$	90			μs
t_{BLANK}	Over current blanking time	TPS22941/2/5	5	10	20	ms
t_{RSTART}	Auto-restart time	TPS22941/2/5	40	80	160	ms
	Short-circuit response time	$V_{IN} = V_{ON} = 3.3\text{ V}$, moderate overcurrent condition	9			μs
		$V_{IN} = V_{ON} = 3.3\text{ V}$, hard short	4			μs

TYPICAL PERFORMANCE

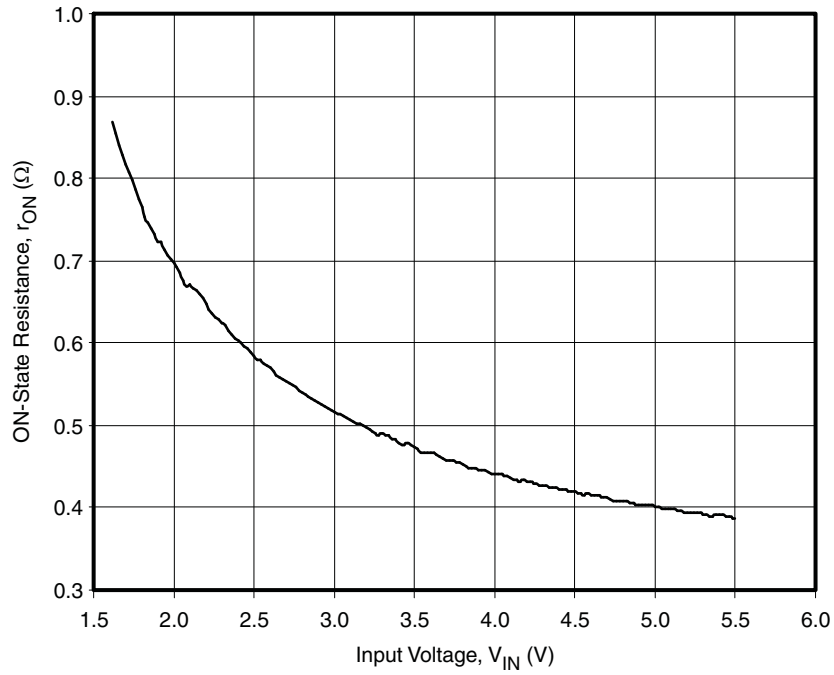

Figure 1. r_{ON} vs V_{IN}

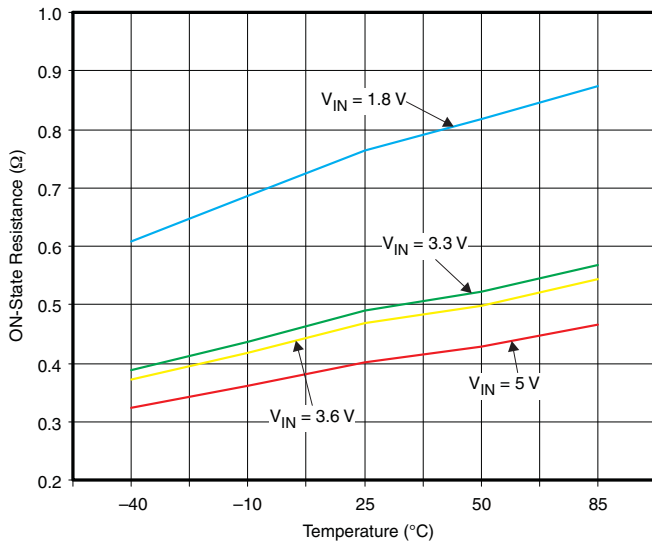

Figure 2. r_{ON} vs Temperature

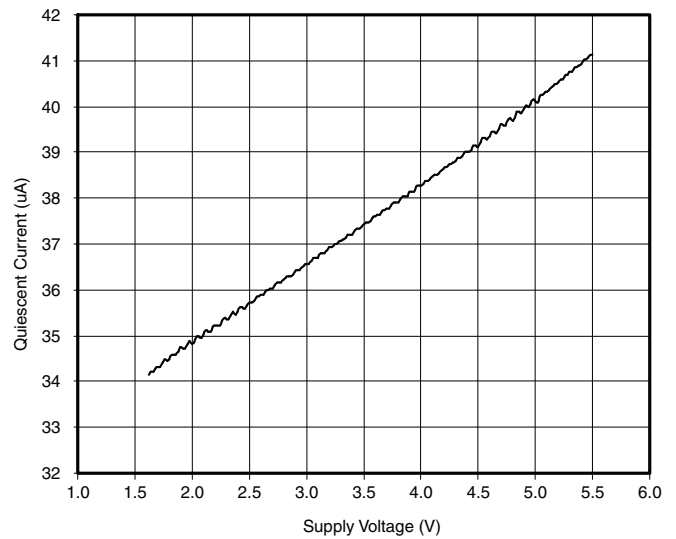

Figure 3. Quiescent Current vs V_{IN}

TYPICAL PERFORMANCE (continued)

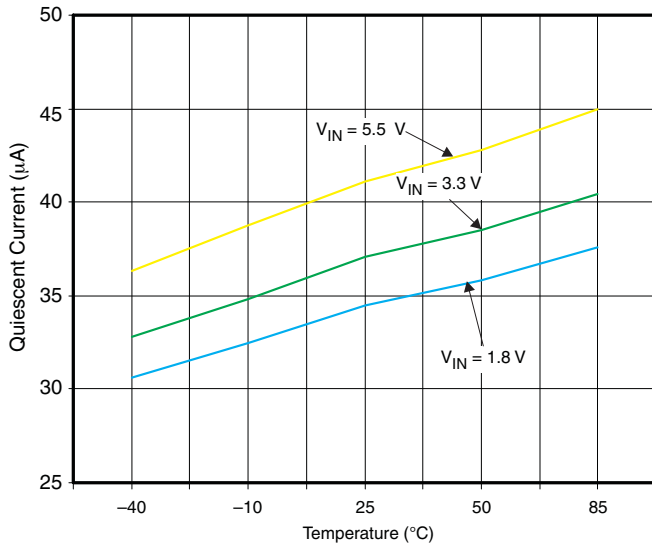

Figure 4. Quiescent Current vs Temperature

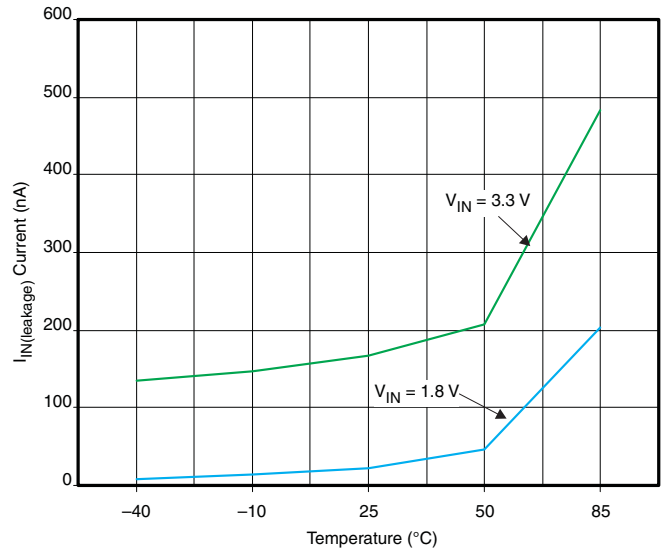

Figure 5. I_{IN(leakage)} vs Temperature

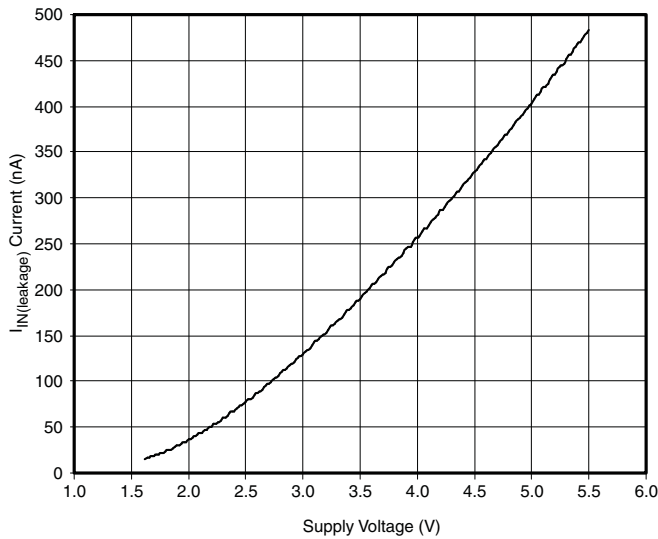

Figure 6. I_{IN(Leakage)} vs V_{IN}

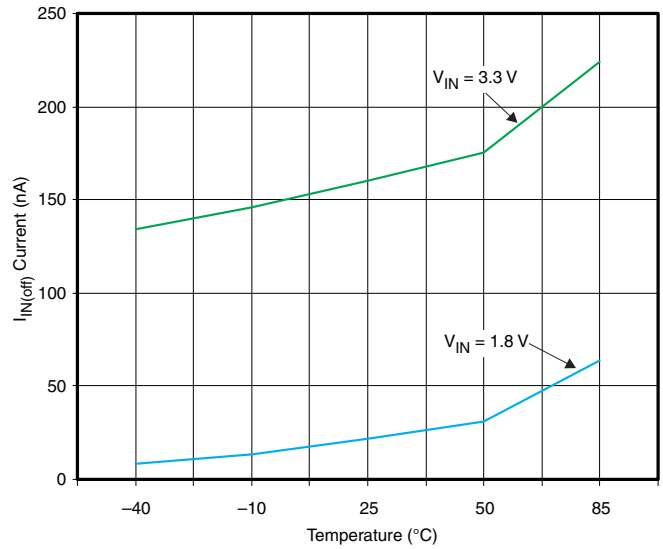

Figure 7. I_{IN(off)} vs Temperature

TYPICAL PERFORMANCE (continued)

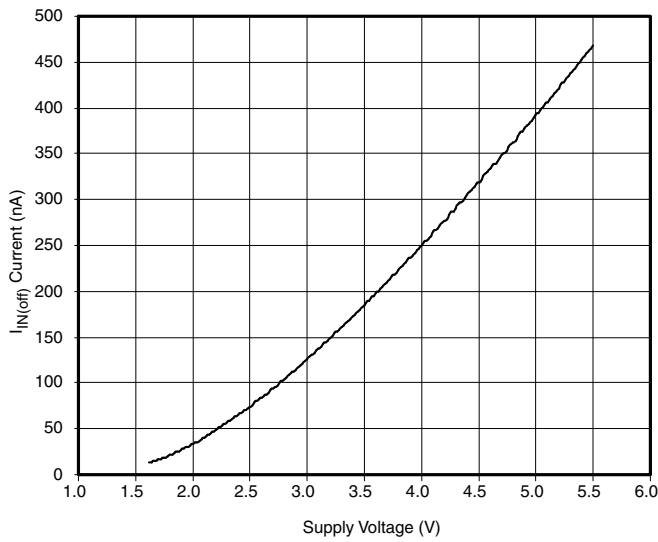

Figure 8. $I_{IN(off)}$ vs V_{IN}

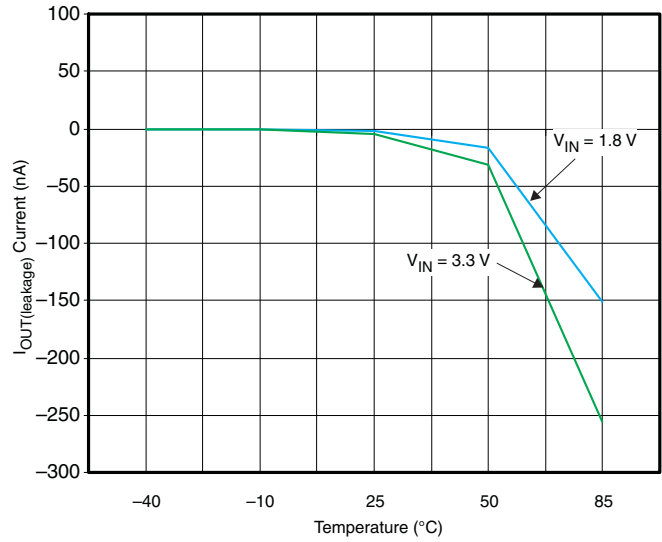

Figure 9. $I_{OUT(leakage)}$ vs Temperature

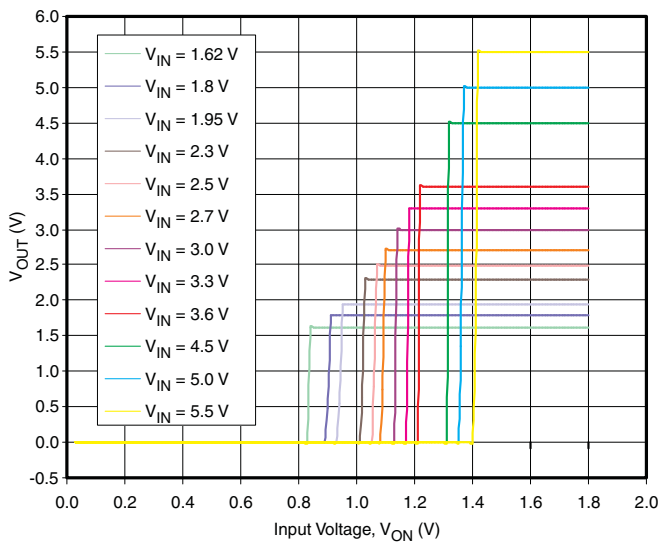

Figure 10. ON Threshold

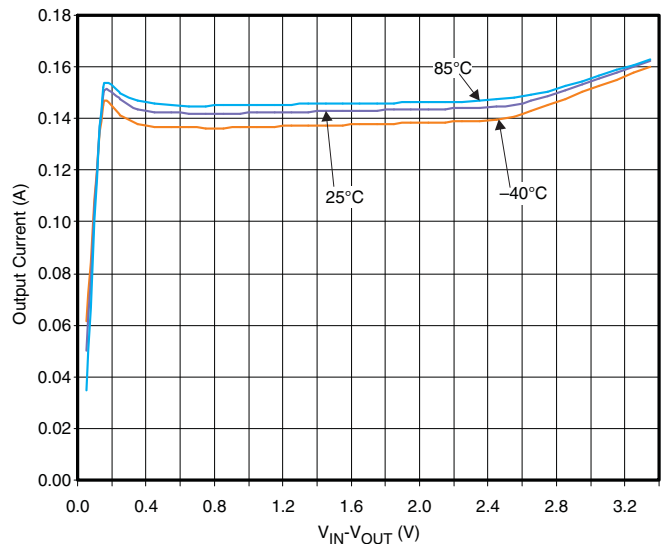

Figure 11. I_{LIM} vs Output Voltage (TPS22942, TPS22944, TPS22945)

TYPICAL PERFORMANCE (continued)

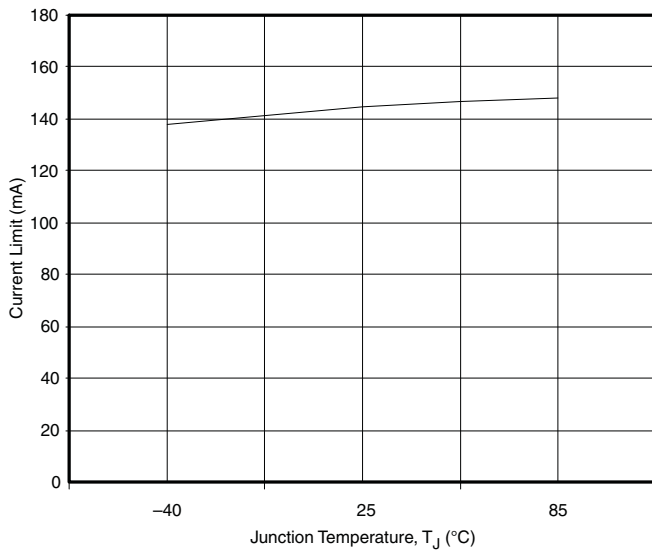

Figure 12. I_{LIM} vs Temperature (TPS22942, TPS22944, TPS22945)

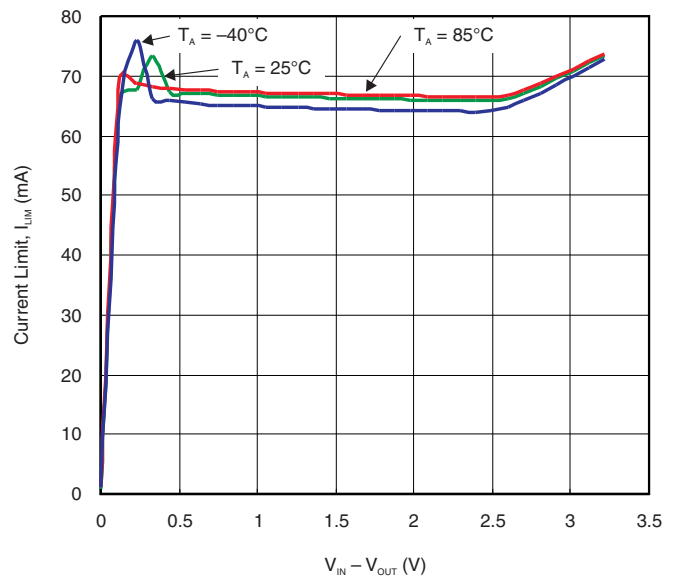

Figure 13. I_{LIM} vs Output Voltage (TPS22941, TPS22943)

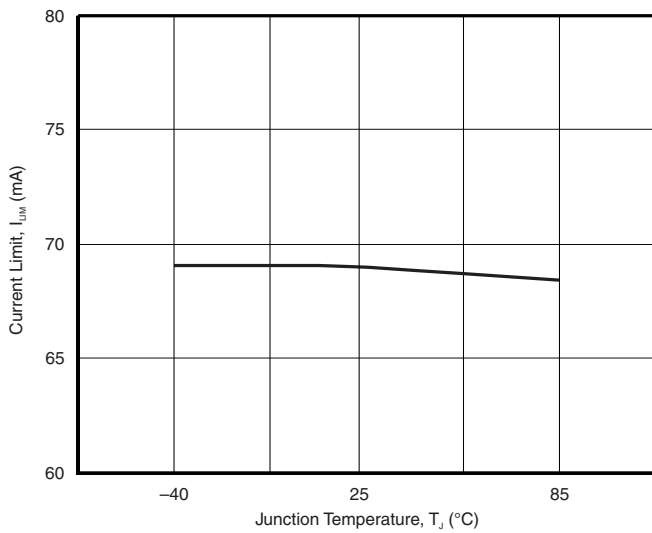

Figure 14. I_{LIM} vs Temperature (TPS22941, TPS22943)

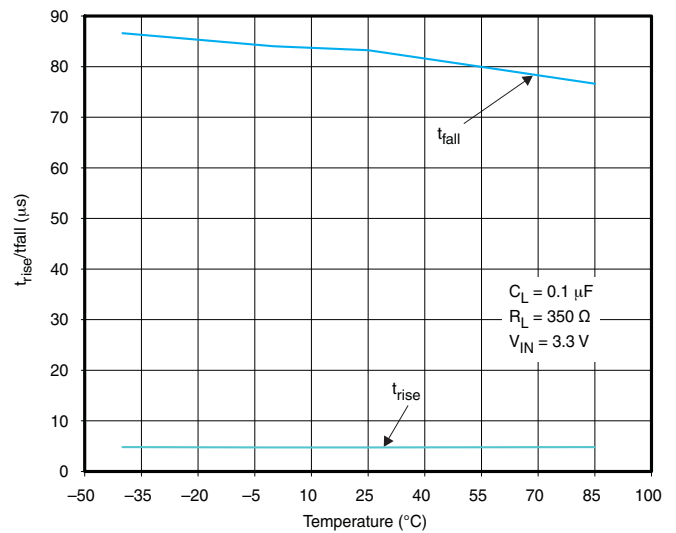

Figure 15. t_{rise}/t_{fall}

TYPICAL PERFORMANCE (continued)

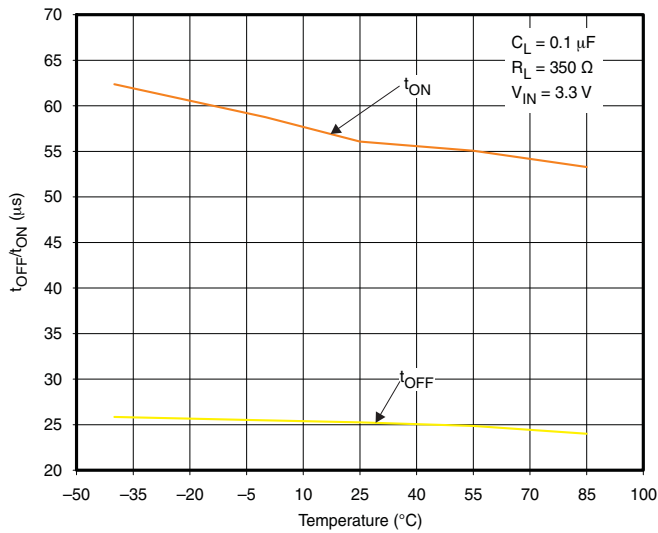

Figure 16. t_{ON}/t_{OFF}

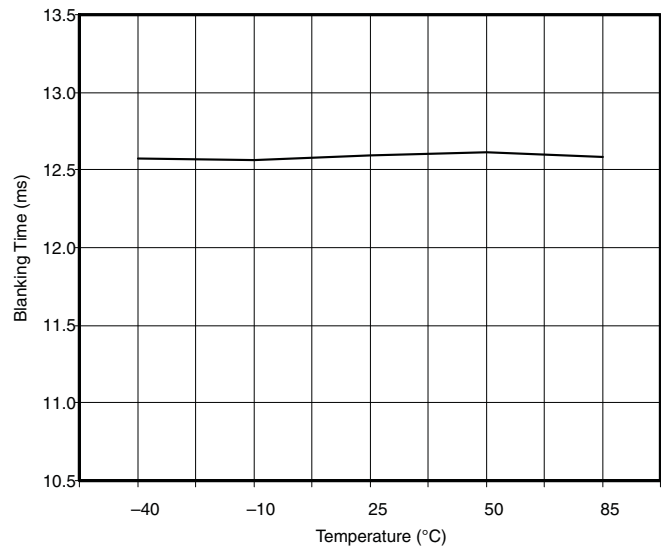

Figure 17. t_{BLANK} vs Temperature ($V_{IN} = 3.3 V$)

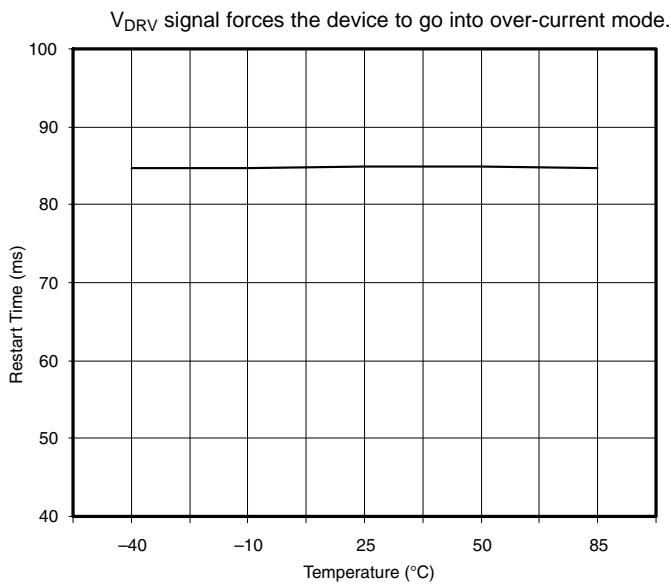

Figure 18. $t_{RESTART}$ vs Temperature ($V_{IN} = 3.3 V$)

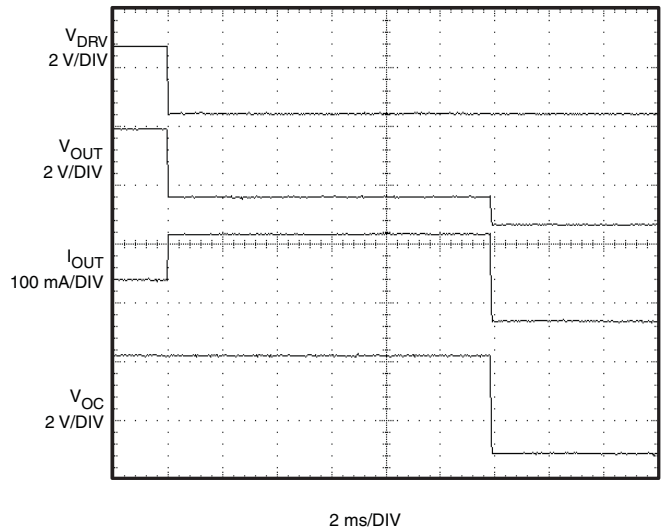

Figure 19. t_{BLANK} Response

V_{DRV} signal forces the device to go into over-current mode.

TYPICAL PERFORMANCE (continued)

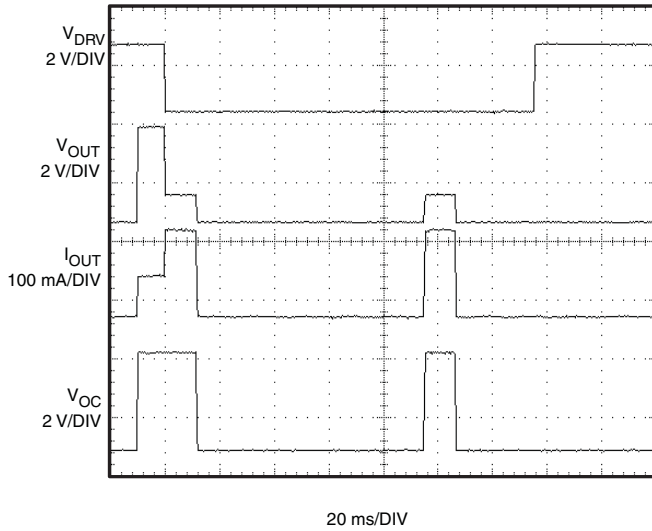

Figure 20. $t_{RESTART}$ Response

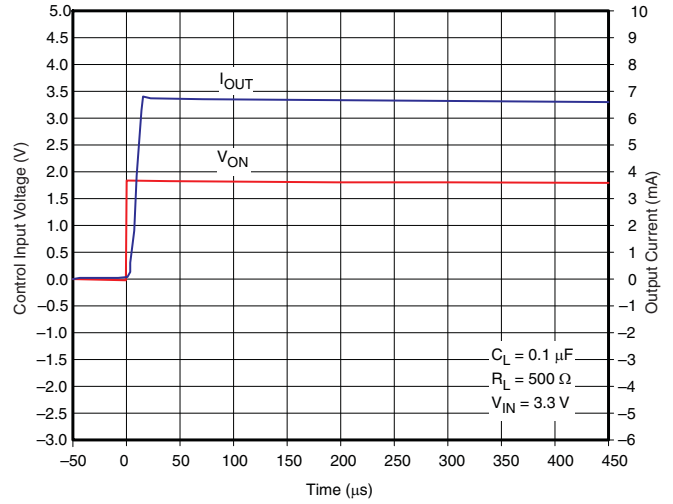

Figure 21. t_{ON} Response

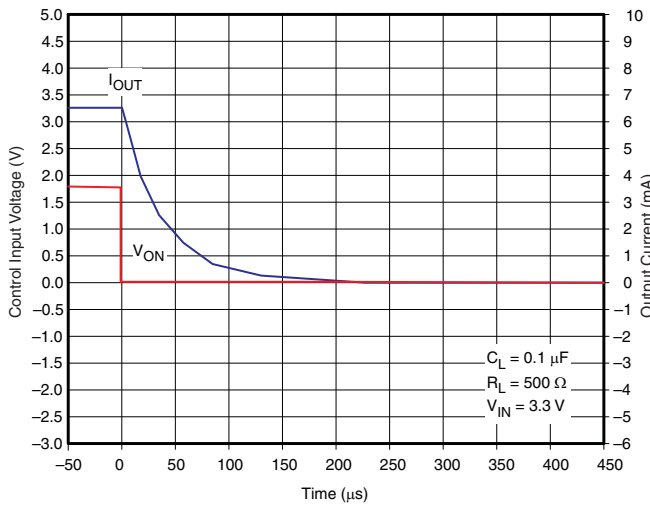

Figure 22. t_{ON} Response

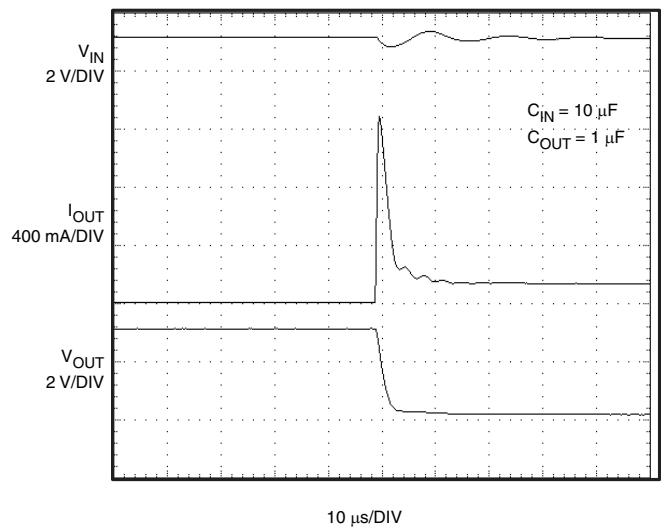

Figure 23. Short-Circuit Response Time (Output Shorted to Ground)

TYPICAL PERFORMANCE (continued)

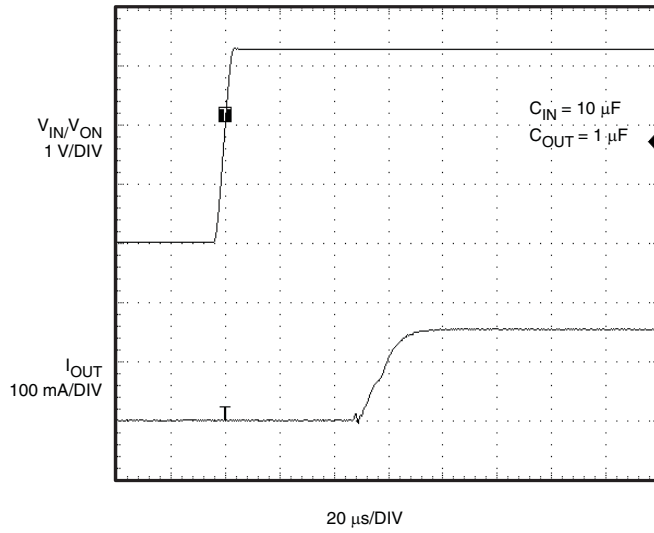

Figure 24. Short-Circuit Response Time (Switch Powerup to Hard Short)

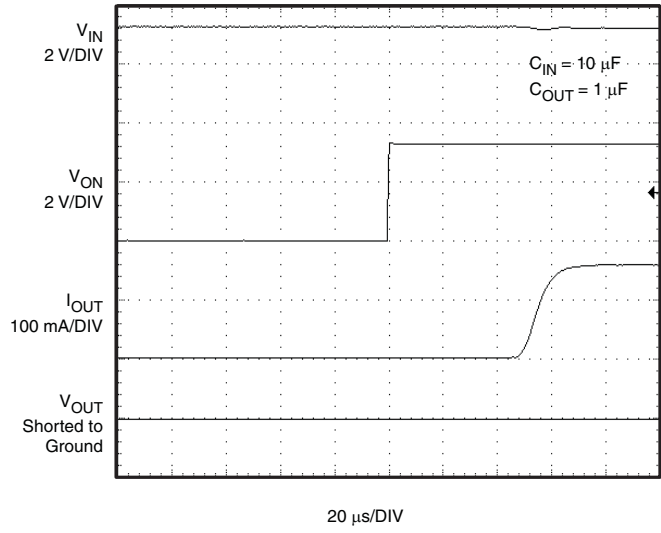

Figure 25. Current Limit Response Time

APPLICATION INFORMATION

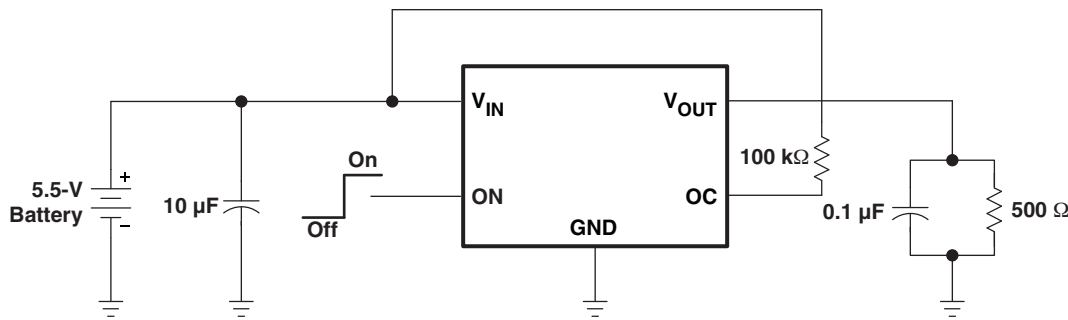

Figure 26. Typical Application Circuit, Active-High Enabled Device (TPS22943, TPS22944 and TPS22945 Only)

On/Off Control

The ON pin controls the state of the switch. Activating ON continuously holds the switch in the on state as long as there is no fault. An undervoltage on V_{IN} or a junction temperature in excess of 150°C overrides the ON control to turn off the switch. ON is active high and has a low threshold, making it capable of interfacing with low-voltage signals.

Undervoltage Lockout

The undervoltage lockout turns off the switch if the input voltage (V_{IN}) drops below the undervoltage lockout threshold. With the ON pin active, the input voltage rising above the undervoltage lockout threshold causes a controlled turn-on of the switch, which limits current overshoots.

Thermal Shutdown

Thermal shutdown protects the part from internally or externally generated excessive temperatures. During an overtemperature condition the switch is turned off. The switch automatically turns on again if the temperature of the die drops below the threshold temperature.

Reverse Voltage

If the voltage at the V_{OUT} pin is larger than the V_{IN} pin, large currents may flow and can cause permanent damage to the device. TPS2294x is designed to control current flow only from V_{IN} to V_{OUT} .

Fault Reporting

When an overcurrent, input undervoltage, or overtemperature condition is detected, OC is set active low to signal the fault mode. OC is an open-drain MOSFET and requires a pullup resistor between V_{IN} and OC. During shutdown, the pulldown on OC is disabled, reducing current draw from the supply.

Current Limiting

When the switch current reaches the maximum limit, the TPS22921/2/3/4/5 operates in a constant-current mode to prohibit excessive currents from causing damage. TPS22921/3 has a current limit of 40 mA and TPS22922/4/5 has a current limit of 100 mA. A current limit condition immediately pulls the fault signal pin low (OC pin), and the part remains in the constant-current mode until the switch current falls below the current limit.

Input Capacitor

To limit the voltage drop on the input supply caused by transient in-rush currents when the switch turns-on into a discharged load capacitor or a short-circuit, a capacitor needs to be placed between V_{IN} and GND. A 1-µF ceramic capacitor, C_{IN} , placed close to the pins is usually sufficient. Higher values of C_{IN} can be used to further reduce the voltage drop.

Output Capacitor

A 0.1- μ F capacitor, C_{OUT} , should be placed between V_{OUT} and GND. This capacitor will prevent parasitic board inductances from forcing V_{OUT} below GND when the switch turns off. For the TPS2294x, the total output capacitance needs to be kept below a maximum value, $C_{OUT(max)}$, to prevent the part from registering an over-current condition and turning-off the switch. The maximum output capacitance can be determined from the following formula, $C_{OUT} = I_{LIM(MAX)} \times t_{BLANK(MIN)} \div V_{IN}$

Due to the integral body diode in the PMOS switch, a C_{IN} greater than C_{OUT} is highly recommended. A C_{OUT} greater than C_{IN} can cause V_{OUT} to exceed V_{IN} when the system supply is removed. This could result in current flow through the body diode from V_{OUT} to V_{IN} .

Power Dissipation

During normal operation as a switch, the power dissipation is small and has little effect on the operating temperature of the part. The parts with the higher current limits will dissipate the most power and that will only be,

$$P = (I_{LIM})^2 \times r_{ON} = (0.2)^2 \times 0.4 = 16 \text{ mW when } V_{IN} = 5.5 \text{ V}$$

If the part goes into current limit the maximum power dissipation will occur when the output is shorted to ground. For TPS22941/2/5, the power dissipation scales by the auto-restart time ($t_{RESTART}$) and the overcurrent blanking time (t_{BLANK}) so that the maximum power dissipated is:

$$P(max) = (t_{BLANK} \div (t_{RESTART} + t_{BLANK})) \times (V_{IN(max)}) \times I_{LIM(max)} = (10 \div (80 + 10)) \times 5.5 \times 0.2 = 122 \text{ mW}$$

When using the TPS22943 and TPS22944, a short on the output causes the part to operate in a constant current state, dissipating a worst-case power as calculated above until the thermal shutdown activates. It then cycles in and out of thermal shutdown so long as the ON pin is active and the short is present.

Board Layout

For best performance, all traces should be as short as possible. To be most effective, the input and output capacitors should be placed close to the device to minimize the effects that parasitic trace inductances may have on normal and short-circuit operation. Using wide traces for V_{IN} , V_{OUT} , and GND will help minimize parasitic electrical effects along with minimizing the case to ambient thermal impedance.

PACKAGING INFORMATION

Orderable Device	Status (1)	Package Type	Package Drawing	Pins	Package Qty	Eco Plan (2)	Lead/Ball Finish	MSL Peak Temp (3)	Op Temp (°C)	Top-Side Markings (4)	Samples
TPS22941DCKR	ACTIVE	SC70	DCK	5	3000	Green (RoHS & no Sb/Br)	CU NIPDAU	Level-1-260C-UNLIM	-40 to 85	4AN	Samples
TPS22942DCKR	ACTIVE	SC70	DCK	5	3000	Green (RoHS & no Sb/Br)	CU NIPDAU	Level-1-260C-UNLIM	-40 to 85	(4BJ ~ 4BN)	Samples
TPS22942DCKRG4	ACTIVE	SC70	DCK	5	3000	Green (RoHS & no Sb/Br)	CU NIPDAU	Level-1-260C-UNLIM	-40 to 85	(4BJ ~ 4BN)	Samples
TPS22943DCKR	ACTIVE	SC70	DCK	5	3000	Green (RoHS & no Sb/Br)	CU NIPDAU	Level-1-260C-UNLIM	-40 to 85	4CN	Samples
TPS22944DCKR	ACTIVE	SC70	DCK	5	3000	Green (RoHS & no Sb/Br)	CU NIPDAU	Level-1-260C-UNLIM	-40 to 85	4DN	Samples
TPS22945DCKR	ACTIVE	SC70	DCK	5	3000	Green (RoHS & no Sb/Br)	CU NIPDAU	Level-1-260C-UNLIM	-40 to 85	(4EJ ~ 4EN)	Samples
TPS22945DCKRG4	ACTIVE	SC70	DCK	5	3000	Green (RoHS & no Sb/Br)	CU NIPDAU	Level-1-260C-UNLIM	-40 to 85	(4EJ ~ 4EN)	Samples

(1) The marketing status values are defined as follows:

ACTIVE: Product device recommended for new designs.

LIFEBUY: TI has announced that the device will be discontinued, and a lifetime-buy period is in effect.

NRND: Not recommended for new designs. Device is in production to support existing customers, but TI does not recommend using this part in a new design.

PREVIEW: Device has been announced but is not in production. Samples may or may not be available.

OBSELETE: TI has discontinued the production of the device.

(2) Eco Plan - The planned eco-friendly classification: Pb-Free (RoHS), Pb-Free (RoHS Exempt), or Green (RoHS & no Sb/Br) - please check <http://www.ti.com/productcontent> for the latest availability information and additional product content details.

TBD: The Pb-Free/Green conversion plan has not been defined.

Pb-Free (RoHS): TI's terms "Lead-Free" or "Pb-Free" mean semiconductor products that are compatible with the current RoHS requirements for all 6 substances, including the requirement that lead not exceed 0.1% by weight in homogeneous materials. Where designed to be soldered at high temperatures, TI Pb-Free products are suitable for use in specified lead-free processes.

Pb-Free (RoHS Exempt): This component has a RoHS exemption for either 1) lead-based flip-chip solder bumps used between the die and package, or 2) lead-based die adhesive used between the die and leadframe. The component is otherwise considered Pb-Free (RoHS compatible) as defined above.

Green (RoHS & no Sb/Br): TI defines "Green" to mean Pb-Free (RoHS compatible), and free of Bromine (Br) and Antimony (Sb) based flame retardants (Br or Sb do not exceed 0.1% by weight in homogeneous material)

(3) MSL, Peak Temp. -- The Moisture Sensitivity Level rating according to the JEDEC industry standard classifications, and peak solder temperature.

(4) Multiple Top-Side Markings will be inside parentheses. Only one Top-Side Marking contained in parentheses and separated by a "~" will appear on a device. If a line is indented then it is a continuation of the previous line and the two combined represent the entire Top-Side Marking for that device.

Important Information and Disclaimer: The information provided on this page represents TI's knowledge and belief as of the date that it is provided. TI bases its knowledge and belief on information provided by third parties, and makes no representation or warranty as to the accuracy of such information. Efforts are underway to better integrate information from third parties. TI has taken and continues to take reasonable steps to provide representative and accurate information but may not have conducted destructive testing or chemical analysis on incoming materials and chemicals. TI and TI suppliers consider certain information to be proprietary, and thus CAS numbers and other limited information may not be available for release.

In no event shall TI's liability arising out of such information exceed the total purchase price of the TI part(s) at issue in this document sold by TI to Customer on an annual basis.

TAPE AND REEL INFORMATION

QUADRANT ASSIGNMENTS FOR PIN 1 ORIENTATION IN TAPE

*All dimensions are nominal

Device	Package Type	Package Drawing	Pins	SPQ	Reel Diameter (mm)	Reel Width W1 (mm)	A0 (mm)	B0 (mm)	K0 (mm)	P1 (mm)	W (mm)	Pin1 Quadrant
TPS22941DCKR	SC70	DCK	5	3000	180.0	9.2	2.3	2.55	1.2	4.0	8.0	Q3
TPS22942DCKR	SC70	DCK	5	3000	180.0	9.2	2.3	2.55	1.2	4.0	8.0	Q3
TPS22943DCKR	SC70	DCK	5	3000	180.0	9.2	2.3	2.55	1.2	4.0	8.0	Q3
TPS22944DCKR	SC70	DCK	5	3000	180.0	9.2	2.3	2.55	1.2	4.0	8.0	Q3
TPS22945DCKR	SC70	DCK	5	3000	180.0	9.2	2.3	2.55	1.2	4.0	8.0	Q3

TAPE AND REEL BOX DIMENSIONS

*All dimensions are nominal

Device	Package Type	Package Drawing	Pins	SPQ	Length (mm)	Width (mm)	Height (mm)
TPS22941DCKR	SC70	DCK	5	3000	205.0	200.0	33.0
TPS22942DCKR	SC70	DCK	5	3000	205.0	200.0	33.0
TPS22943DCKR	SC70	DCK	5	3000	205.0	200.0	33.0
TPS22944DCKR	SC70	DCK	5	3000	205.0	200.0	33.0
TPS22945DCKR	SC70	DCK	5	3000	205.0	200.0	33.0

DCK (R-PDSO-G5)

PLASTIC SMALL-OUTLINE PACKAGE

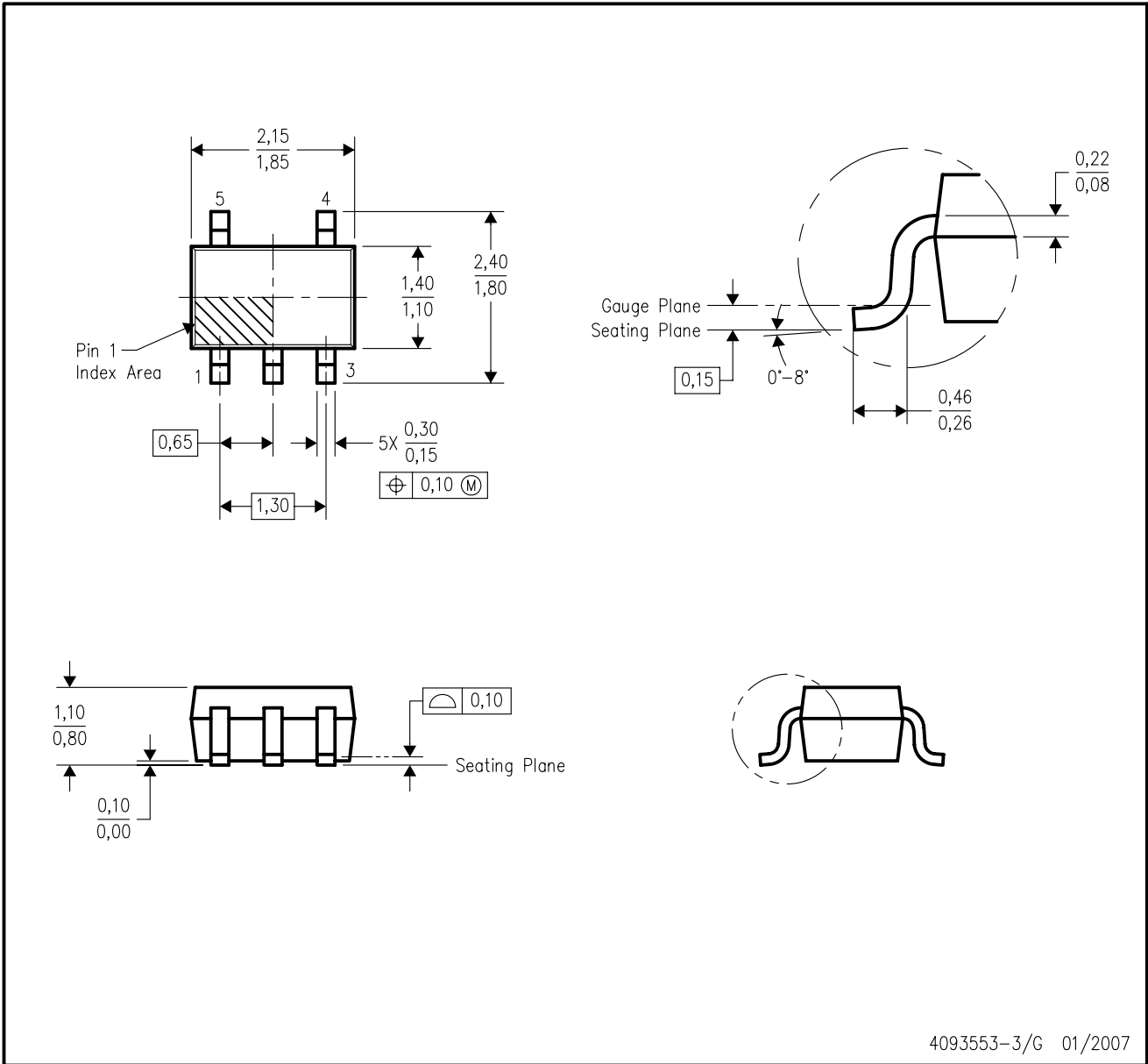

4093553-3/G 01/2007

- NOTES:
- A. All linear dimensions are in millimeters.
 - B. This drawing is subject to change without notice.
 - C. Body dimensions do not include mold flash or protrusion. Mold flash and protrusion shall not exceed 0.15 per side.
 - D. Falls within JEDEC MO-203 variation AA.

DCK (R-PDSO-G5)

PLASTIC SMALL OUTLINE



- NOTES:
- A. All linear dimensions are in millimeters.
 - B. This drawing is subject to change without notice.
 - C. Customers should place a note on the circuit board fabrication drawing not to alter the center solder mask defined pad.
 - D. Publication IPC-7351 is recommended for alternate designs.
 - E. Laser cutting apertures with trapezoidal walls and also rounding corners will offer better paste release. Customers should contact their board assembly site for stencil design recommendations. Example stencil design based on a 50% volumetric metal load solder paste. Refer to IPC-7525 for other stencil recommendations.

IMPORTANT NOTICE

Texas Instruments Incorporated and its subsidiaries (TI) reserve the right to make corrections, enhancements, improvements and other changes to its semiconductor products and services per JESD46, latest issue, and to discontinue any product or service per JESD48, latest issue. Buyers should obtain the latest relevant information before placing orders and should verify that such information is current and complete. All semiconductor products (also referred to herein as "components") are sold subject to TI's terms and conditions of sale supplied at the time of order acknowledgment.

TI warrants performance of its components to the specifications applicable at the time of sale, in accordance with the warranty in TI's terms and conditions of sale of semiconductor products. Testing and other quality control techniques are used to the extent TI deems necessary to support this warranty. Except where mandated by applicable law, testing of all parameters of each component is not necessarily performed.

TI assumes no liability for applications assistance or the design of Buyers' products. Buyers are responsible for their products and applications using TI components. To minimize the risks associated with Buyers' products and applications, Buyers should provide adequate design and operating safeguards.

TI does not warrant or represent that any license, either express or implied, is granted under any patent right, copyright, mask work right, or other intellectual property right relating to any combination, machine, or process in which TI components or services are used. Information published by TI regarding third-party products or services does not constitute a license to use such products or services or a warranty or endorsement thereof. Use of such information may require a license from a third party under the patents or other intellectual property of the third party, or a license from TI under the patents or other intellectual property of TI.

Reproduction of significant portions of TI information in TI data books or data sheets is permissible only if reproduction is without alteration and is accompanied by all associated warranties, conditions, limitations, and notices. TI is not responsible or liable for such altered documentation. Information of third parties may be subject to additional restrictions.

Resale of TI components or services with statements different from or beyond the parameters stated by TI for that component or service voids all express and any implied warranties for the associated TI component or service and is an unfair and deceptive business practice. TI is not responsible or liable for any such statements.

Buyer acknowledges and agrees that it is solely responsible for compliance with all legal, regulatory and safety-related requirements concerning its products, and any use of TI components in its applications, notwithstanding any applications-related information or support that may be provided by TI. Buyer represents and agrees that it has all the necessary expertise to create and implement safeguards which anticipate dangerous consequences of failures, monitor failures and their consequences, lessen the likelihood of failures that might cause harm and take appropriate remedial actions. Buyer will fully indemnify TI and its representatives against any damages arising out of the use of any TI components in safety-critical applications.

In some cases, TI components may be promoted specifically to facilitate safety-related applications. With such components, TI's goal is to help enable customers to design and create their own end-product solutions that meet applicable functional safety standards and requirements. Nonetheless, such components are subject to these terms.

No TI components are authorized for use in FDA Class III (or similar life-critical medical equipment) unless authorized officers of the parties have executed a special agreement specifically governing such use.

Only those TI components which TI has specifically designated as military grade or "enhanced plastic" are designed and intended for use in military/aerospace applications or environments. Buyer acknowledges and agrees that any military or aerospace use of TI components which have **not** been so designated is solely at the Buyer's risk, and that Buyer is solely responsible for compliance with all legal and regulatory requirements in connection with such use.

TI has specifically designated certain components as meeting ISO/TS16949 requirements, mainly for automotive use. In any case of use of non-designated products, TI will not be responsible for any failure to meet ISO/TS16949.

Products

Audio	www.ti.com/audio
Amplifiers	amplifier.ti.com
Data Converters	dataconverter.ti.com
DLP® Products	www.dlp.com
DSP	dsp.ti.com
Clocks and Timers	www.ti.com/clocks
Interface	interface.ti.com
Logic	logic.ti.com
Power Mgmt	power.ti.com
Microcontrollers	microcontroller.ti.com
RFID	www.ti-rfid.com
OMAP Applications Processors	www.ti.com/omap
Wireless Connectivity	www.ti.com/wirelessconnectivity

Applications

Automotive and Transportation	www.ti.com/automotive
Communications and Telecom	www.ti.com/communications
Computers and Peripherals	www.ti.com/computers
Consumer Electronics	www.ti.com/consumer-apps
Energy and Lighting	www.ti.com/energy
Industrial	www.ti.com/industrial
Medical	www.ti.com/medical
Security	www.ti.com/security
Space, Avionics and Defense	www.ti.com/space-avionics-defense
Video and Imaging	www.ti.com/video

TI E2E Community

e2e.ti.com



Стандарт Электрон Связь

Мы молодая и активно развивающаяся компания в области поставок электронных компонентов. Мы поставляем электронные компоненты отечественного и импортного производства напрямую от производителей и с крупнейших складов мира.

Благодаря сотрудничеству с мировыми поставщиками мы осуществляем комплексные и плановые поставки широчайшего спектра электронных компонентов.

Собственная эффективная логистика и склад в обеспечивает надежную поставку продукции в точно указанные сроки по всей России.

Мы осуществляем техническую поддержку нашим клиентам и предпродажную проверку качества продукции. На все поставляемые продукты мы предоставляем гарантию .

Осуществляем поставки продукции под контролем ВП МО РФ на предприятия военно-промышленного комплекса России , а также работаем в рамках 275 ФЗ с открытием отдельных счетов в уполномоченном банке. Система менеджмента качества компании соответствует требованиям ГОСТ ISO 9001.

Минимальные сроки поставки, гибкие цены, неограниченный ассортимент и индивидуальный подход к клиентам являются основой для выстраивания долгосрочного и эффективного сотрудничества с предприятиями радиоэлектронной промышленности, предприятиями ВПК и научно-исследовательскими институтами России.

С нами вы становитесь еще успешнее!

Наши контакты:

Телефон: +7 812 627 14 35

Электронная почта: sales@st-electron.ru

Адрес: 198099, Санкт-Петербург,
Промышленная ул, дом № 19, литера Н,
помещение 100-Н Офис 331