

JPS350 Series

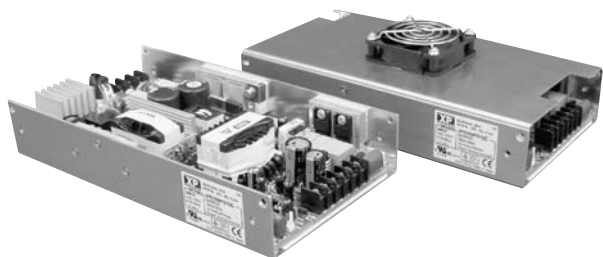

- 300 W with Convection Cooling
- High Efficiency - up to 90%
- Remote On/Off & Remote Sense
- Meets 1U, Low Profile Requirements
- Zero Voltage Switching Technology
- AC OK & DC OK Signals
- Current Sharing

Specification

Input

Input Voltage	• 85-264 VAC (170-370 VDC)
Input Frequency	• 47-63 Hz
Input Current	• 4 A/2 A max at 115 VAC/230 VAC
Inrush Current	• 30 A at 115 VAC, 60 A at 230 VAC
Power Factor	• 0.99 typical
Earth Leakage Current	• 2.0 mA max 264 VAC/60 Hz
Input Protection	• Internal 6.3 A, 250 V fuse

Output

Output Voltage	• See table
Output Voltage Trim	• $\pm 10\%$ single output models only
Initial Set Accuracy	• At 60% rated load $\pm 1\%$ output V1 & V2, $\pm 5\%$ on output V3 & V4
Minimum Load	• No minimum load required on single output models. For multi-output models see note 5
Start Up Delay	• 2 s typical
Start Up Rise Time	• 100 ms typical
Hold Up Time	• 20 ms min at low line
Line Regulation	• $\pm 0.5\%$ at rated load across input voltage range
Load Regulation	• $\pm 1\%$ for single output models & V1 & V2 of multi-output models $\pm 5\%$ for V3 & V4
Tolerance	• $\pm 1\%$
Transient Response	• 4% max deviation, recovery to within 1% in 500 μ s for a 25% load change
Ripple & Noise	• $\pm 1\%$ max pk-pk, 20 MHz BW
Overvoltage Protection	• 115-140%, recycle input to reset
Overtemperature Protection	• Shuts down at $+110^\circ\text{C}$, auto recovery
Overload Protection	• 120-150%, auto recovery
Short Circuit Protection	• Trip and restart (Hiccup mode)
Temperature Coefficient	• $\pm 0.05\%/^\circ\text{C}$
Remote Sense	• Compensates for up to 0.5 V drop
Remote On/Off	• On = Logic Low or Open Off = Logic High
Current Share	• Single wire current sharing (4 supplies can be paralleled)
Fan Output	• See mechanical detail notes

General

Efficiency	• Up to 90%
Isolation	• 3000 VAC Input to Output 1500 VAC Input to Ground 500 VAC Output to Ground
Switching Frequency	• 120 kHz typical for PFC & PWM
Power Density	• 4.96 W/In ³
Signals	• AC OK, DC OK and Remote On/Off (see control and supervisory signals)
MTBF	• 100 kHrs per MIL-HDBK-217F

Environmental

Operating Temperature	• 0°C to $+70^\circ\text{C}$, (see derating curve) Full power to $+50^\circ\text{C}$
Cooling	• 350 W with 18 CFM airflow 300 W convection cooling
Operating Humidity	• 5-95% RH, non-condensing
Storage Temperature	• -20°C to $+85^\circ\text{C}$
Operating Altitude	• 3000 m
Vibration	• 2 g, 10-55 Hz, 3 mins/cycle for 30 mins each axis

EMC & Safety

Emissions	• EN55022, level B conducted FCC 20780, level B conducted
Harmonic Currents	• EN61000-3-2
Voltage Flicker	• EN61000-3-3
ESD Immunity	• EN61000-4-2, level 3 Perf Criteria A
Radiated Immunity	• EN61000-4-3, 10 V/m Perf Criteria A
EFT/Burst	• EN61000-4-4, level 3 Perf Criteria A
Surge	• EN61000-4-5, level 3 Perf Criteria A
Safety Approvals	• EN60950-1:2001, UL60950-1, CSA C22.2 No. 60950-1, CE Mark LVD

Models and Ratings

JPS350 - Single Output XP

Output Power	Output Voltage	Output Current		Ripple & Noise Pk-Pk ⁽²⁾	Model Number ⁽¹⁾
		Convection-cooled	18 CFM		
315 W	5 V	54.0 A	63.0 A	50 mV	JPS350PS05C†^
350 W	12 V	25.0 A	30.0 A	120 mV	JPS350PS12C†^
	15 V	20.0 A	24.0 A	120 mV	JPS350PS15C†^
	24 V	13.0 A	15.0 A	200 mV	JPS350PS24C†^
	48 V	6.5 A	7.3 A	200 mV	JPS350PS48C†^

Notes

1. For non-current share version delete suffix 'C' from model number.

2. Ripple and noise measured over 15 MHz bandwidth with a 47 µF electrolytic capacitor and 0.47 µF ceramic capacitor.

† Available from Farnell. See pages 204-206.

^ Available from Newark. See pages 207-208.

Mechanical Details

All dimensions are in inches (mm)

Weight: 2.12 lbs (960 g) approx.

Tolerance: ±0.03 (0.8) max.

All models (except JPS350PS05)

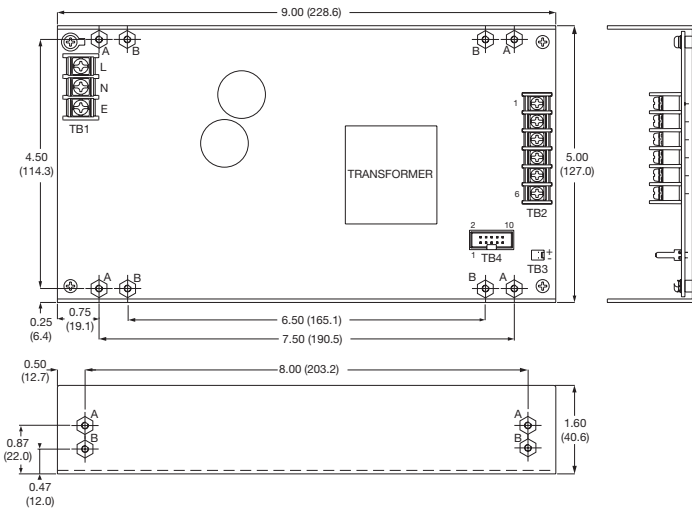

PIN CONNECTIONS			
Pin	TB2		TB4
	JPS350PS05	All other models	All models
1	+5 V	+V	N/C
2	+5 V	+V	N/C
3	0 V	+V	+Remote sense
4	0 V	0 V	DC OK
5	0 V	0 V	-Remote sense
6	0 V	0 V	N/C
7	+5 V		Current Share ⁽¹⁾
8	+5 V		Remote On/Off
9			AC OK
10			0 V

Notes:

- For current share operation, connect signal 0 V (pin 10) between units and current share (pin 7) between units. For non 'C' models pin 7 is not used.
- TB3 is for fan, with Molex 5045-02A or equivalent. 12 V at 200 mA (except JPS350PS05, 5 V at 500 mA).
- TB1 (AC input) and TB2 (DC output) are terminal blocks.
- TB4 signal connector is Molex 70246-10 or equivalent.
- Maximum mounting screw penetration is 0.16 (4.0) from chassis outer surface.
- Fan/Cover option available, order part number:
5 V models: JPS350 F/CVR 5†^
All other models: JPS350 F/CVR†^
Alternatively, add suffix '-E' to model number to receive cover fitted to the unit 4.95 x 8.92 x 2.48 (127.0 x 228.6 x 62.9).

Fixing Holes:

A = #6-32 screw mounting holes

B = M3 x 0.5 screw mounting holes

JPS350PS05

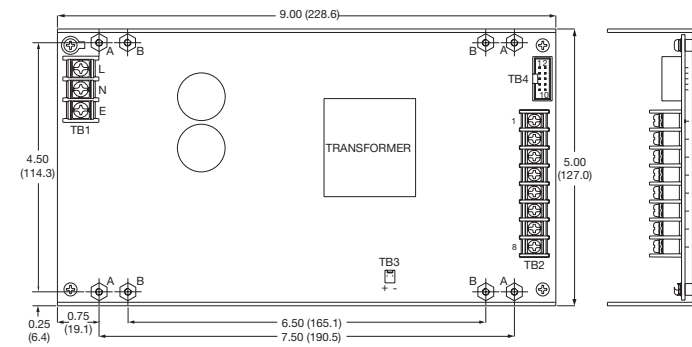

Application Notes

Derating Curve

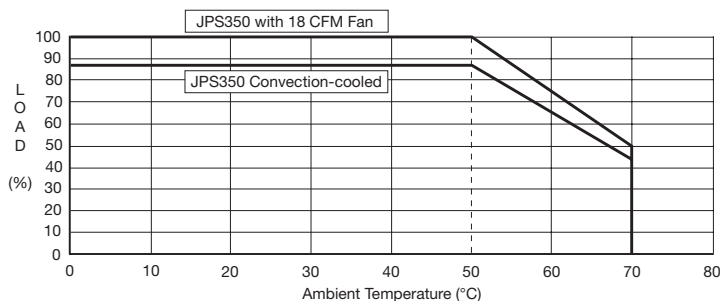

Signals

- To turn off the output, apply 5 V to the Remote On/Off.
- AC OK is a TTL signal which goes LOW when input falls below 60 VAC at rated load.
- DC OK is a TTL signal which goes LOW when PSU is in an overcurrent condition, overvoltage condition, disabled or when output falls out of regulation.
- For AC OK and DC OK signals, source current is 1 mA, sink current is 6 mA.

Models and Ratings

Output 1			Output 2			Output 3			Output 4			Model Number
Output V1	Conv. Cooled	Max 18 CFM	Output V2	Conv. Cooled	Max 18 CFM	Output V3	Conv. Cooled	Max 18 CFM	Output V4	Conv. Cooled	Max 18 CFM	
3.3 V	20 A	35 A	5 V	20 A	35 A	12 V	4.5 A	6 A	-12 V	1.0 A	3 A	JPS350PQ46 ⁽²⁾
5.0 V	25 A	35 A	12 V	10 A	14 A	-12 V	2.0 A	3 A	-5 V	1.0 A	2 A	JPS350PQ41
5.0 V	25 A	35 A	12 V	6 A	8 A	24 V	3.0 A	4 A	-12 V	2.0 A	3 A	JPS350PQ47
5.0 V	25 A	35 A	15 V	5 A	7 A	24 V	3.0 A	4 A	-15 V	1.6 A	3 A	JPS350PQ48

Notes

- Maximum power is 350 W with 18 CFM forced air or 300 W with convection cooling.
- JPS350PQ46 requires 22 CFM max. OVP on V2 (5 V output) not V1.
- For current share option add suffix 'C' to model number.
- Current share models are built to order.
- All models require 2 A minimum load on V1. On V2, JPS350PQ46 requires 1 A, PQ41 requires 0.5 A and PQ47/48 requires 2 A.

Mechanical Details

All dimensions are in inches (mm)
Tolerance: ±0.03 (0.8) max.

Weight: 2.12 lbs (960 g) approx.

JPS350PQ41/47/48

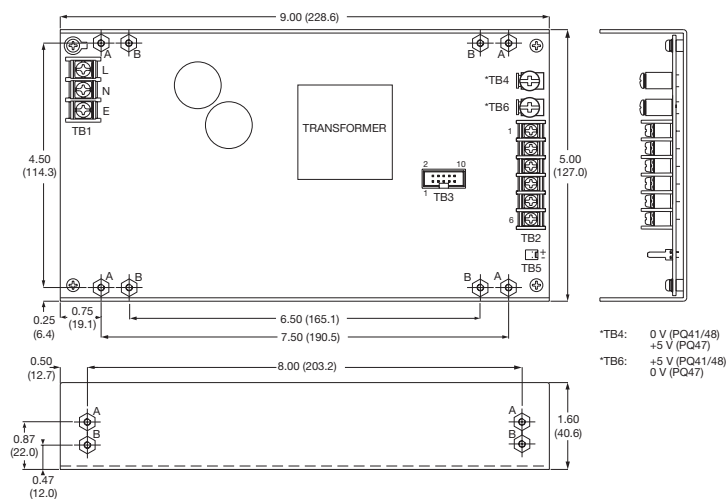

PIN CONNECTIONS - TB3				
Pin	PQ41	PQ46	PQ47	PQ48
1	+5 V +S	+5 V +S	+5 V +S	+5 V +S
2	+5 V PS ⁽⁶⁾	+5 V PS ⁽⁶⁾	+5 V PS ⁽⁶⁾	+5 V PS ⁽⁶⁾
3	+12 V +S	+3.3 V +S	+12 V +S	+15 V +S
4	DC OK	DC OK	DC OK	DC OK
5	+12 V -S	+3.3 V -S	+12 V -S	+15 V -S
6	+5 V -S	+5 V -S	+5 V -S	+5 V -S
7	+12 V PS ⁽⁶⁾	+3.3 V PS ⁽⁶⁾	+12 V PS ⁽⁶⁾	+15 V PS ⁽⁶⁾
8	Remote On/Off	Remote On/Off	Remote On/Off	Remote On/Off
9	AC OK	AC OK	AC OK	AC OK
10	0 V	0 V	0 V	0 V

PIN CONNECTIONS - TB2				
Pin	PQ41	PQ46	PQ47	PQ48
1	-12 V	0 V	-12 V	-15 V
2	-5 V	+12 V	+24 V	+24 V
3	0 V	-12 V	0 V	0 V
4	0 V	0 V	0 V	0 V
5	0 V		0 V	0 V
6	+12 V		+12 V	+15 V

JPS350PQ46

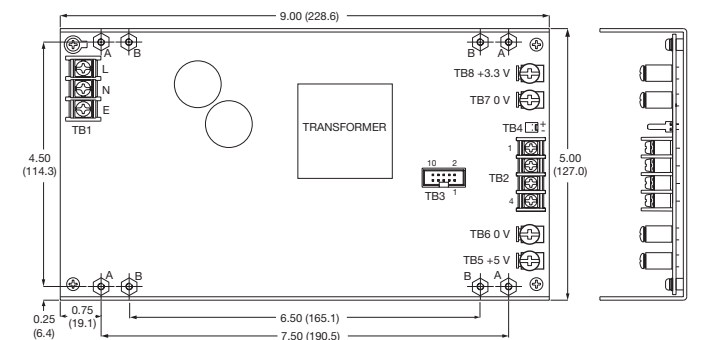

Notes:

- TB5 (PQ41/47/48) and TB4 (PQ46) is for fan with Molex 5045-02A or equivalent, PQ47/PQ48 24 V at 100 mA, PQ41/PQ46 12 V at 200 mA.
- TB1 (AC input) and TB2 (DC output) are terminal blocks.
- TB3 signal connector is Molex 70246-10 or equivalent.
- Maximum mounting screw penetration is 0.16 (4.0) from chassis outer surface.
- Fan/Cover option available, order part number:
PQ41, PQ46: JPS350 F/CVR† PQ48 & PQ47: JPS350 F/CVR. Alternatively, add suffix '-E' to model number to receive cover fitted to the unit.
- PS - Single wire parallel on 'C' models only. No connection on standard models.

Fixing Holes:

- A = #6-32 screw mounting holes
- B = M3 x 0.5 screw mounting holes

Application Notes

Derating Curve

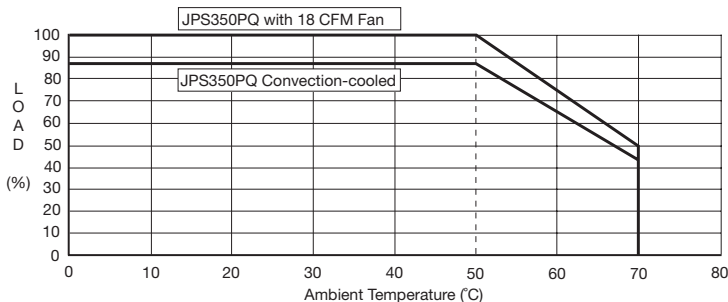

Signals

- To turn off the output, apply 5 V to the remote On/Off.
- AC OK is a TTL signal which goes LOW when input falls below 60 VAC at rated load.
- DC OK is a TTL signal which goes LOW when PSU is in an overcurrent condition, overvoltage condition, disabled or when output falls out of regulation.
- For AC OK and DC OK signals, source current is 1 mA, sink current is 6 mA.

Control & Supervisory Signals

JPS350 XP

AC OK Signal

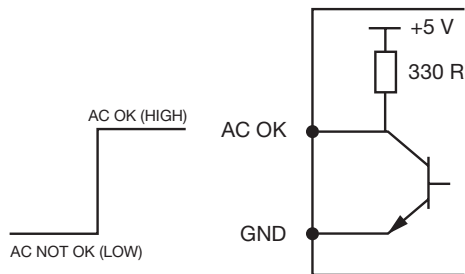

DC OK Signal

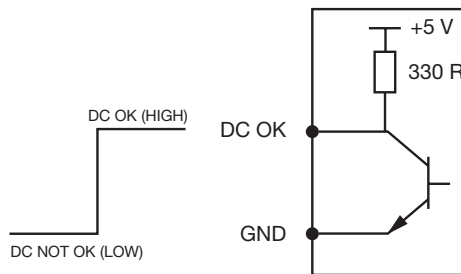

Remote On/Off Control (Inhibit)

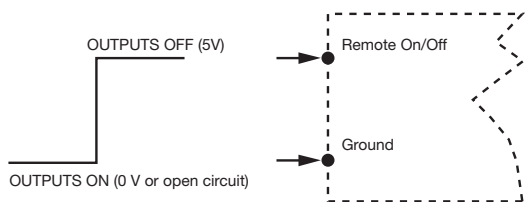

Parallel Connection Utilizing Optional Current Share

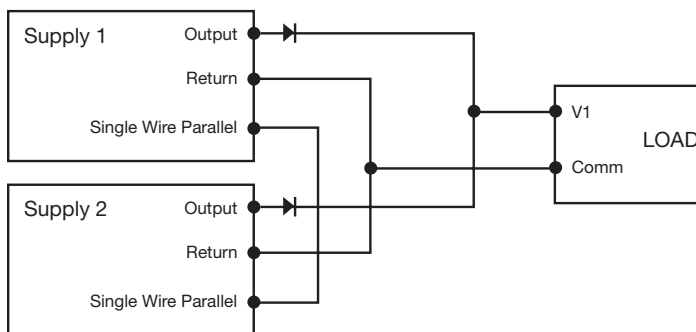

Remote Sense Connection

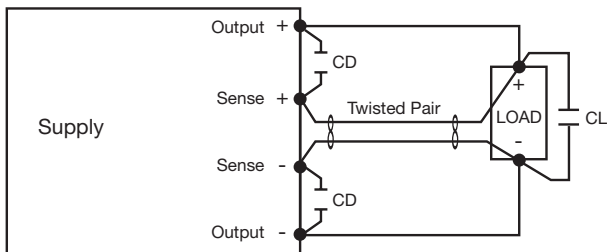

- Notes:**
1. CD is 0.1 μF ceramic capacitor.
 2. CL is 47 μF electrolytic capacitor.

JPS350 Fan/Cover Option

See mechanical details notes for information on how to order.

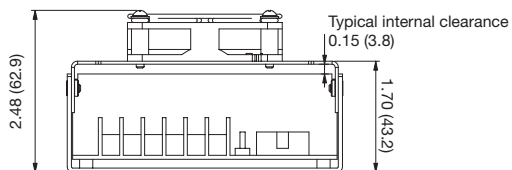
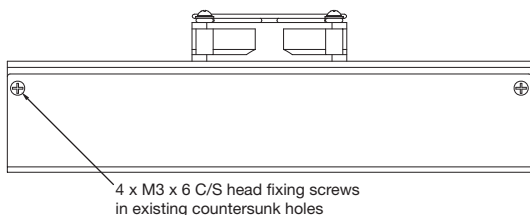
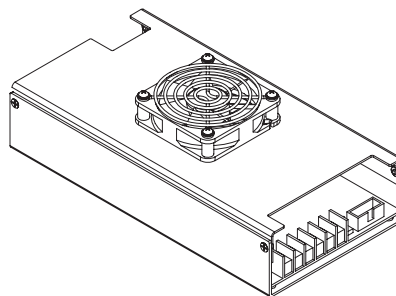
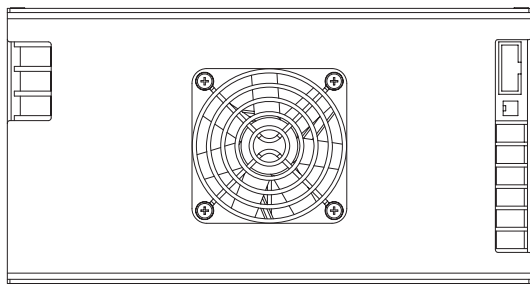



Стандарт Электрон Связь

Мы молодая и активно развивающаяся компания в области поставок электронных компонентов. Мы поставляем электронные компоненты отечественного и импортного производства напрямую от производителей и с крупнейших складов мира.

Благодаря сотрудничеству с мировыми поставщиками мы осуществляем комплексные и плановые поставки широчайшего спектра электронных компонентов.

Собственная эффективная логистика и склад в обеспечивает надежную поставку продукции в точно указанные сроки по всей России.

Мы осуществляем техническую поддержку нашим клиентам и предпродажную проверку качества продукции. На все поставляемые продукты мы предоставляем гарантию .

Осуществляем поставки продукции под контролем ВП МО РФ на предприятия военно-промышленного комплекса России , а также работаем в рамках 275 ФЗ с открытием отдельных счетов в уполномоченном банке. Система менеджмента качества компании соответствует требованиям ГОСТ ISO 9001.

Минимальные сроки поставки, гибкие цены, неограниченный ассортимент и индивидуальный подход к клиентам являются основой для выстраивания долгосрочного и эффективного сотрудничества с предприятиями радиоэлектронной промышленности, предприятиями ВПК и научно-исследовательскими институтами России.

С нами вы становитесь еще успешнее!

Наши контакты:

Телефон: +7 812 627 14 35

Электронная почта: sales@st-electron.ru

Адрес: 198099, Санкт-Петербург,
Промышленная ул, дом № 19, литера Н,
помещение 100-Н Офис 331