

MAX31910/11 Evaluation Kit

Evaluates: MAX31910 and MAX31911

General Description

The MAX31910/11 evaluation kit (EV kit) provides the hardware and software (graphical user interface) necessary to evaluate the MAX31910 and MAX31911 industrial octal digital input translators/serializers. The EV kit includes a MAX31910AUI+ or MAX31911AUI+ installed as well as a digital isolator and USB-to-SPI interface.

The USB to SPI Dongle is a separate PCB that can be used to interact with the EV kit software. This dongle is optional and is not necessary for the proper operation of the MAX31910/11 if the user supplies the SPI interface.

This EV kit is intended for functional and parametric evaluation of the IC only; it is not intended for EMC testing.

EV Kit Contents

- ◆ Assembled Circuit Board including MAX31910AUI+ or MAX31911AUI+
- ◆ USB to SPI Dongle
- ◆ Mini-USB Cable

Features

- ◆ Easy Evaluation of the MAX31910 and MAX31911
- ◆ Fully Assembled and Tested
- ◆ USB HID Interface
- ◆ Digital Isolator
- ◆ Windows XP® OS- and Windows® 7 OS-Compatible Software
- ◆ RoHS Compliant

MAX31910/11 EV Kit Files

FILE	DESCRIPTION
MAX31910_11EVKitSoftwareInstall.EXE	Application program

Note: The .EXE file is downloaded as a .ZIP file.

MAX31910/11 EV Kit

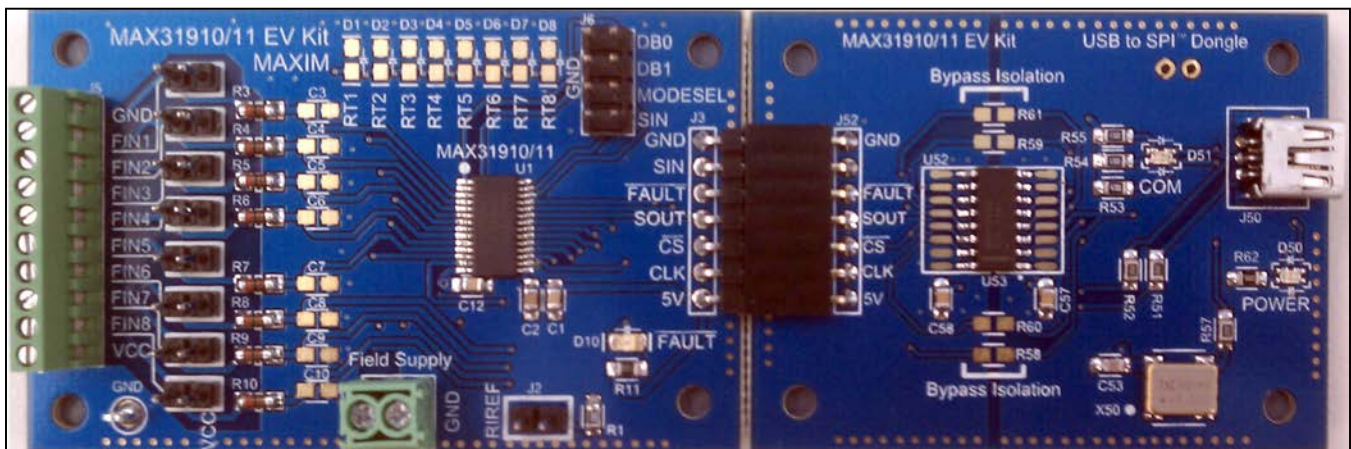

[Ordering Information](#) appears at end of data sheet.

Windows and Windows XP are registered trademarks of Microsoft Corp.

For pricing, delivery, and ordering information, please contact Maxim Direct at 1-888-629-4642, or visit Maxim's website at www.maximintegrated.com.

MAX31910/11 Evaluation Kit

Evaluates: MAX31910 and MAX31911

Quick Start

Note: In the following sections, software-related items are identified by bolding. Text in **bold** refers to items directly from the install or EV kit software. Text in **bold and underlined** refers to items from the Windows operating system.

Required Equipment

- PC with Windows XP or Windows 7 OS
- USB port
- Mini-USB cable (included)
- EV kit hardware (included)
- USB to SPI Dongle (included)
- Screw driver
- Wire
- Power supply

Procedure

The MAX31910/11 EV kit is fully assembled and tested. Follow the steps below to verify board operation.

- 1) Connect the USB to SPI Dongle (J52) to the EV kit connector J3.
- 2) Install jumpers on RIREF (J2) and SIN-GND (J6).
- 3) Set the EV kit hardware on a non-conductive surface that will ensure that nothing on the PCB will get shorted to the workspace.
- 4) Use the wires to connect J1 (VCC and GND) to a power supply and tighten the screws on the wire.
- 5) Prior to starting the GUI, connect the EV kit hardware to a PC using the supplied mini-USB cable, or equivalent. The POWER LED (D50) should be green and the COM LED (D51) should be red and slowly flash orange.
- 6) Windows should automatically begin installing the necessary device driver. The USB interface of the EV kit hardware is configured as a HID device and therefore does not require a unique/custom device driver. Once the driver installation is complete, a Windows message will appear near the System Icon menu indicating that the hardware is ready to use. Do not attempt to run the GUI prior to this message. If you do, then you will have to close the application and restart it once the driver installation is complete. On some versions of Windows, Administrator privileges may be required to install the USB device.
- 7) Once the device driver installation is complete, visit www.maximintegrated.com/evkitsoftware to download the latest version of the EV kit software, **MAX31910_11EVKitSoftwareInstall.ZIP**. Save the EV kit software to a temporary folder.
- 8) Open the .ZIP file and double-click the .EXE file to run the installer. A message box stating **The publisher could not be verified. Are you sure you want to run this software?** may appear. If so, click **Yes**.
- 9) The installer GUI will appear. Click **Next** and then **Install**. Once complete, click **Close**.
- 10) Go to **Start >> All Programs**. Look for the **MAX31910_11EVKitSoftware** folder and click on **MAX31910_11EVKitSoftware.EXE** inside the folder.
- 11) When the GUI appears, the text above the status box should indicate that the EV kit hardware is connected. The COM LED (D51) will change to green.
- 12) Connect field inputs to J5 or install jumpers on FIN1-FIN8 and click **Single Read**.

Detailed Description of Software

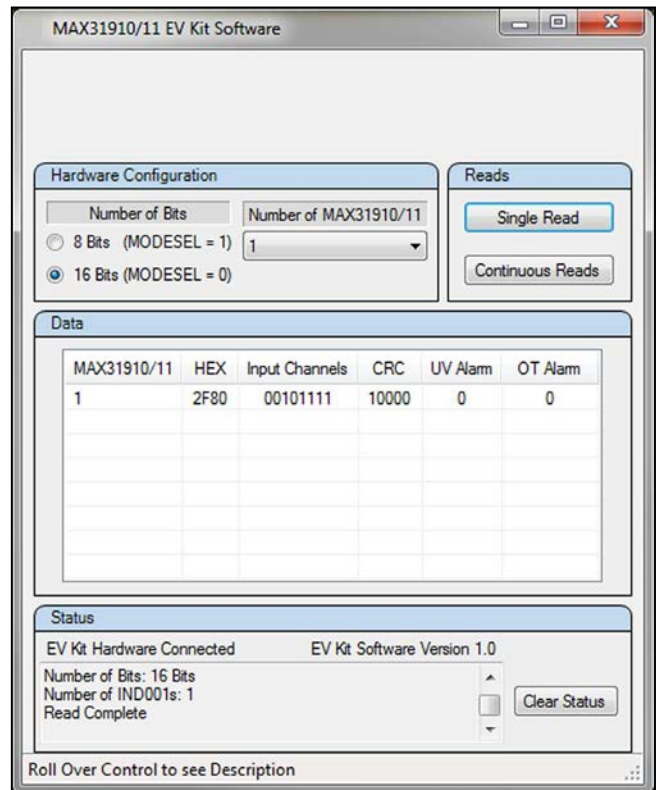

Figure 1. MAX31910/11 EV Kit GUI

MAX31910/11 Evaluation Kit

Evaluates: MAX31910 and MAX31911

Hardware Configuration

In this section the user must provide hardware configuration information about the EV kit. Select the **8 Bits** radio button in the **Number of Bits** section if MODESEL does not have a jumper on J6. Select the **16 Bits** radio button if MODESEL is connected to GND on J6. If there are more MAX31910/11 daisy chained to the EV kit, select the number of devices with the **Number of MAX31910/11** combo box.

Reads

To read the input channels of the devices, select **Single Read**. This will calculate the number of bits to read based on the **Hardware Configuration** settings and then display the read data in the table. **Continuous Reads** will read the input channels every 300ms and display the

data in the table. Once the **Continuous Reads** starts, the button text will change to **Stop** for the user to stop the reads.

Data

The Data table displays the 8 or 16 bits read from each device connected to the EV kit. The first row of data is the first 8 or 16 bits read from the device connected to the microcontroller. The second row is the data read from the device connected to the SIN of the first device (see [Figure 2](#)). The **MAX31910/11** column displays the device name. The device name can be changed by clicking on the name twice. The **HEX** column displays the data in hexadecimal format for each device. The **Input Channels**, **CRC**, **UV Alarm**, and **OT Alarm** columns display the data in binary format.

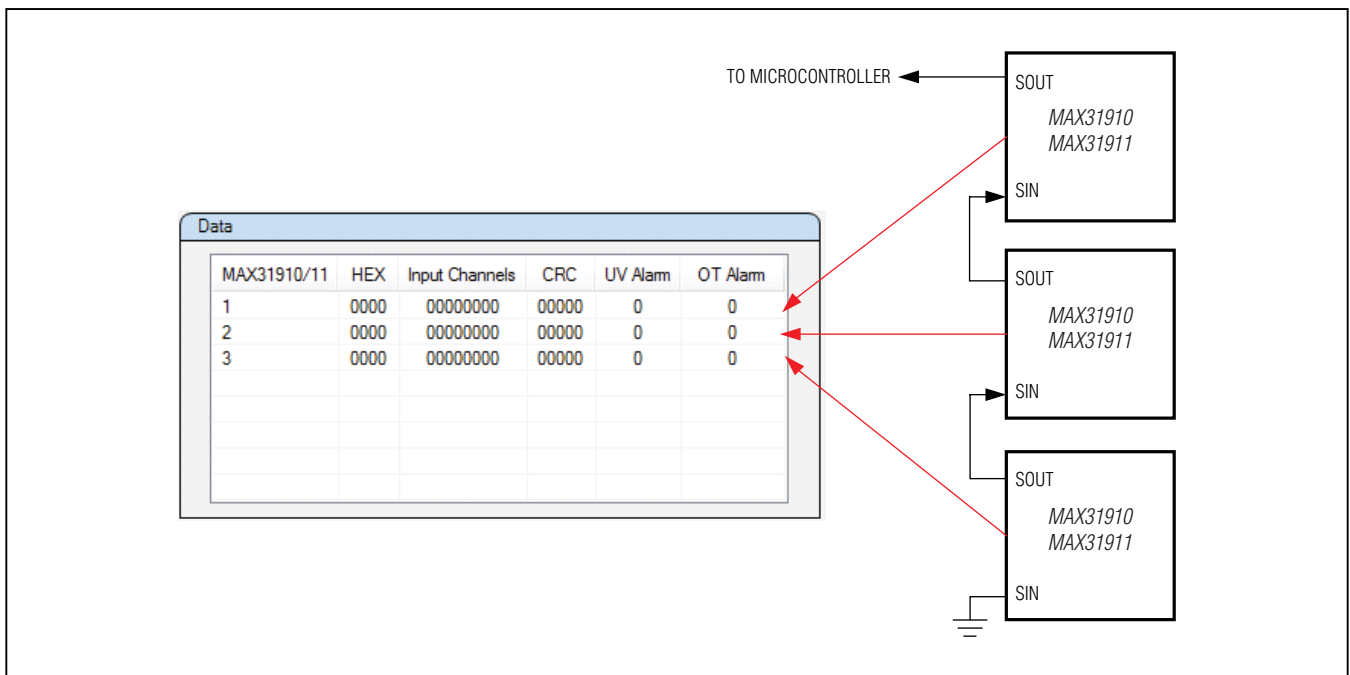

Figure 2. MAX31910/11 Data Table

MAX31910/11 Evaluation Kit

Evaluates: MAX31910 and MAX31911

Table 1. Hardware Configurations

HARDWARE ACTION	COMPONENTS	DESCRIPTION
Connect Field Inputs	J5	Remove pull up jumpers FIN1-FIN8 and connect field inputs to J5.
Adjust Current Limit	J2	Remove jumper on J2 and connect external resistor to the RIREF pin on J2. Connect other end of resistor to GND.
Daisy Chain MAX31910/11	SIN (J6)	Remove SIN jumper on J6 and connect external MAX31910/11 SOUT to SIN on J6.
Remove Isolation	R58 – R61	On the USB to SPI Dongle populate 0Ω resistors on R58 – R61.
Connect User-Supplied SPI Interface	J3	Remove USB to SPI Dongle from J3 and connect user SPI interface to J3 pins. Note: This will also remove the digital isolator. See User-Supplied SPI interface for more details.

Table 2. Description of Jumpers

JUMPER	DESCRIPTION
J2	RIREF: Connects R1 to RIREF pin
J6*	DB0: Pulls DB0 down to GND
	DB1: Pulls DB1 down to GND
	MODESEL: Pulls MODESEL down to GND.
	SIN: Pulls SIN down to GND
FIN1–FIN8	Field Inputs: Connects field input FINX to VIN

*These inputs have internal pullups.

Detailed Description of Hardware

User-Supplied SPI interface

The USB to SPI Dongle is an optional PCB that is only needed to interact with the MAX31910/11 software. The user has the option to supply an external SPI interface to communicate with the MAX31910/11. To connect a user-supplied SPI interface, remove the dongle from J3 and connect an external SPI interface to the pins on J3. Removing the dongle also removes the isolator, so the user may also want to provide an external digital isolator.

Table 3. Description of LEDs

LED	COLOR	DESCRIPTION
D1–D8	Red	Field Input LED Driver: Field input is logic high. Used for future devices
D10	Red	Fault: MAX31910/11 has detected a fault. The field supply is too low or the IC temperature is too high.
D50(POWER)	Red	USB Power Fault: a fault occurred due to over voltage limit, current limit, or thermal limit
	Green	USB Power: USB power supply is on
D51(COM)	Red	Communication: After the software has initialized the hardware the LED will flash red when a command from the PC is received.
	Green	Initialized: Hardware has been initialized by software.

MAX31910/11 Evaluation Kit

Evaluates: MAX31910 and MAX31911

Troubleshooting

All effort was made to ensure that each kit works on the first try, right out of the box. On the rare occasion that a problem is suspected, refer to the below table to help troubleshoot the issue.

SYMPTOM	CHECK	SOLUTION
GUI says hardware not found.	Is the LED labeled D50 red?	If yes, then the electronic fuse, U50, is in a fault state. Inspect for electrical shorts on the PCB and make sure that the PCB is not sitting on a conductive surface.
	Does the LED labeled D51 turn green when the GUI is running?	If not, then exit the GUI and try running it again. If D51 still does not turn green, then exit the GUI and try connecting the USB cable to a different USB port on the PC and wait for a Windows message that states the hardware is ready to use. Run the GUI again.
	Are any of the LEDs illuminated?	If not, then the PCB may not be getting power from USB. Try a different USB cable or a different USB port
CRC returns all 0s or all 1s.	J6 (MODESEL)	Place a jumper on J6 (MODESEL) for the MAX31910/11 to be in 16-bit mode.

MAX31910/11 Evaluation Kit

Evaluates: MAX31910 and MAX31911

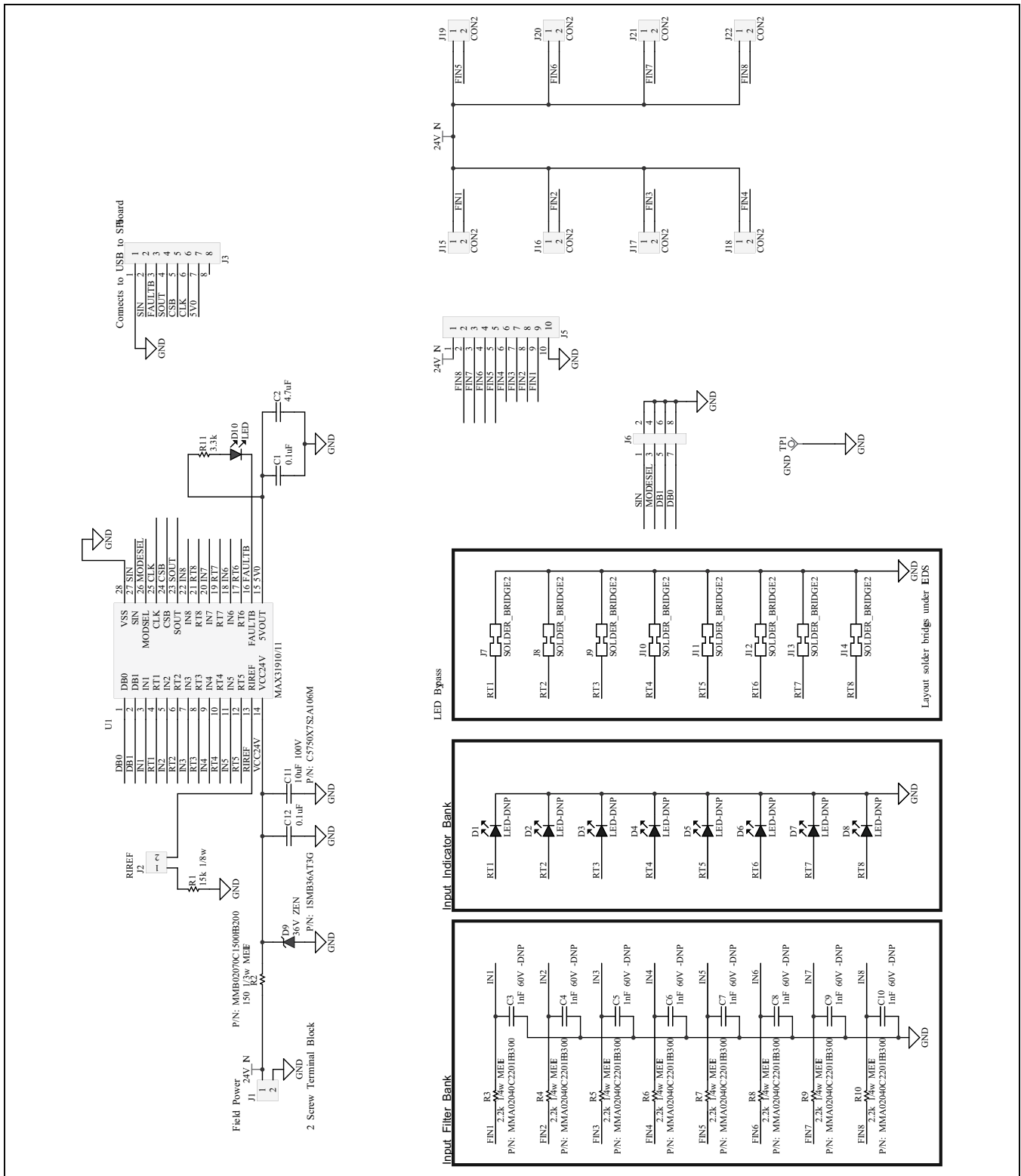

Figure 3. MAX31910/11 EV Kit Schematic (Sheet 1 of 2)

MAX31910/11 Evaluation Kit

Evaluates: MAX31910 and MAX31911

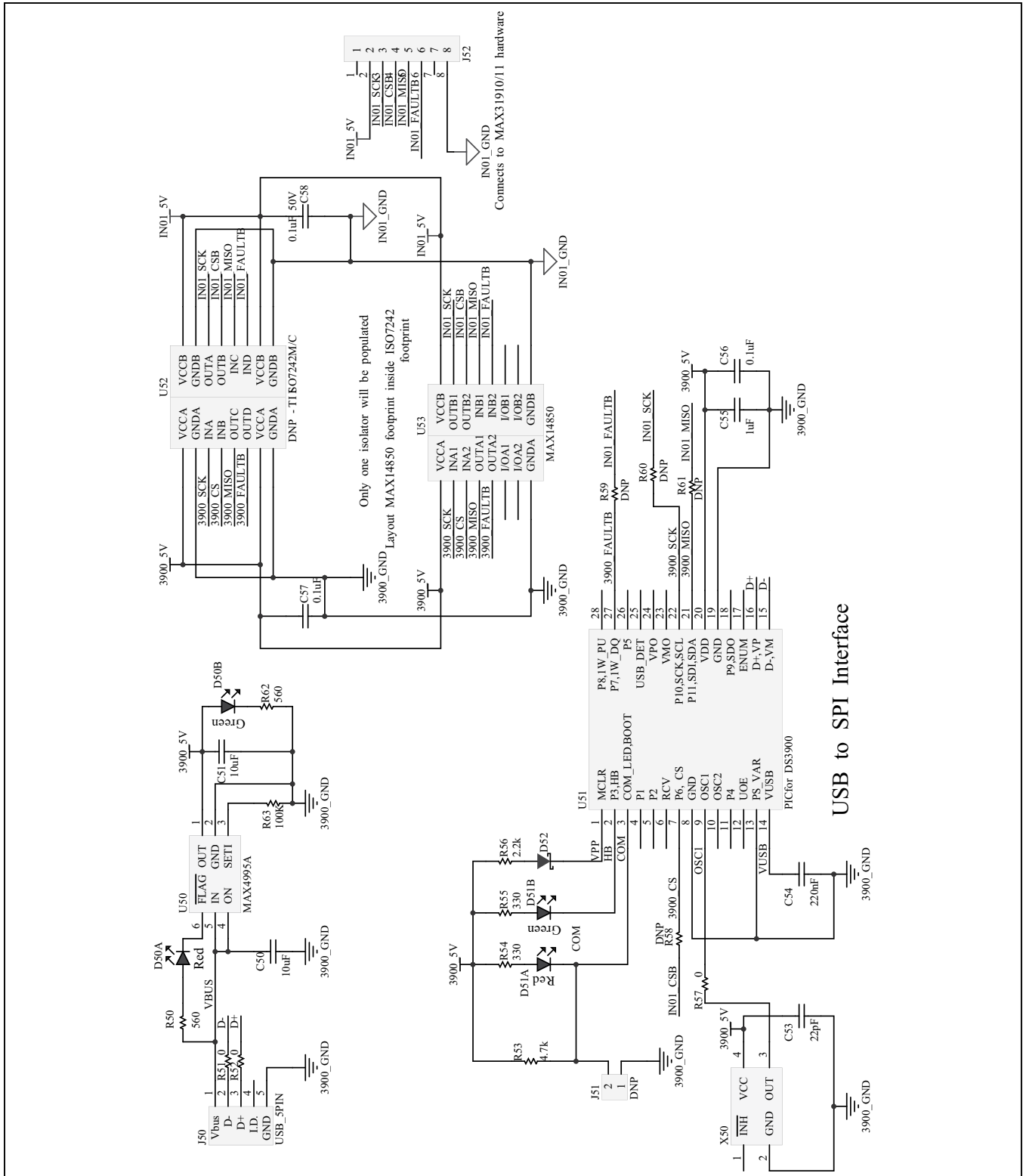

Figure 4. MAX31910/11 EV Kit Schematic (Sheet 2 of 2)

MAX31910/11 Evaluation Kit

Evaluates: MAX31910 and MAX31911

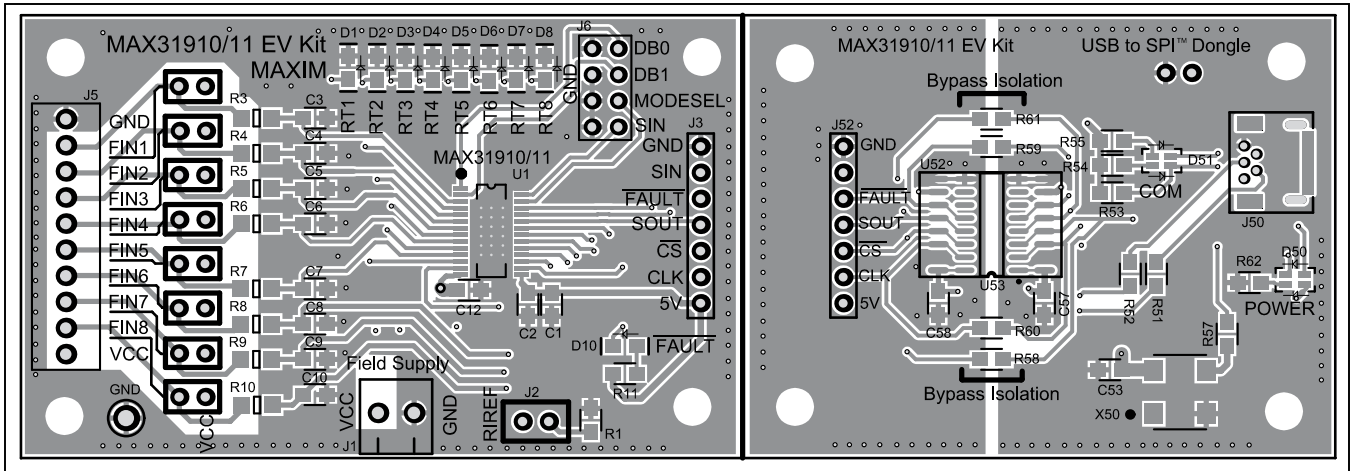

Figure 5. MAX31910/11 EV Kit PCB Layout—Top

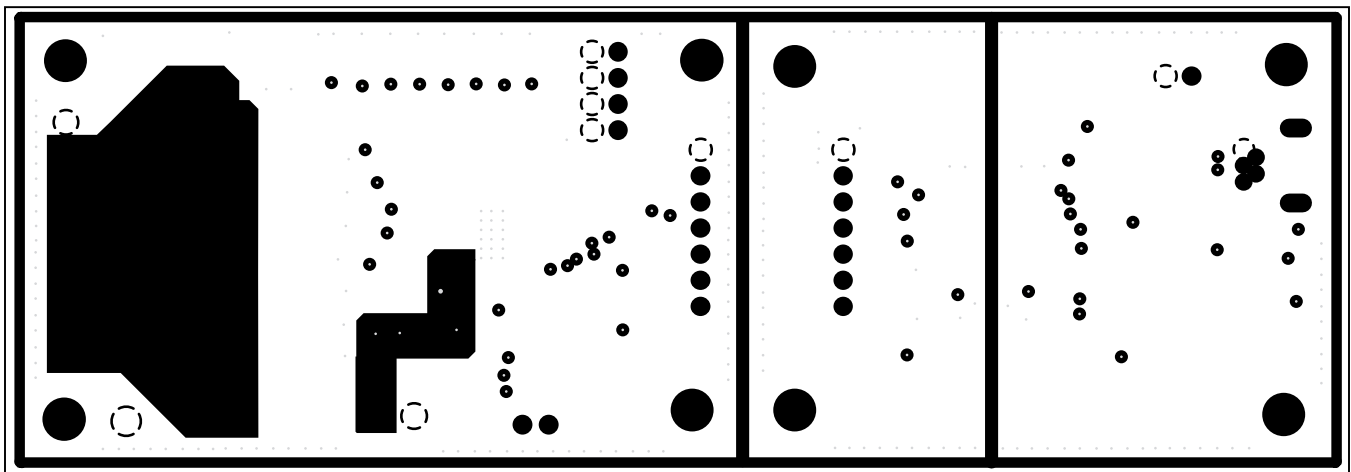

Figure 6. MAX31910/11 EV Kit PCB Layout—Internal Layer 1

MAX31910/11 Evaluation Kit

Evaluates: MAX31910 and MAX31911

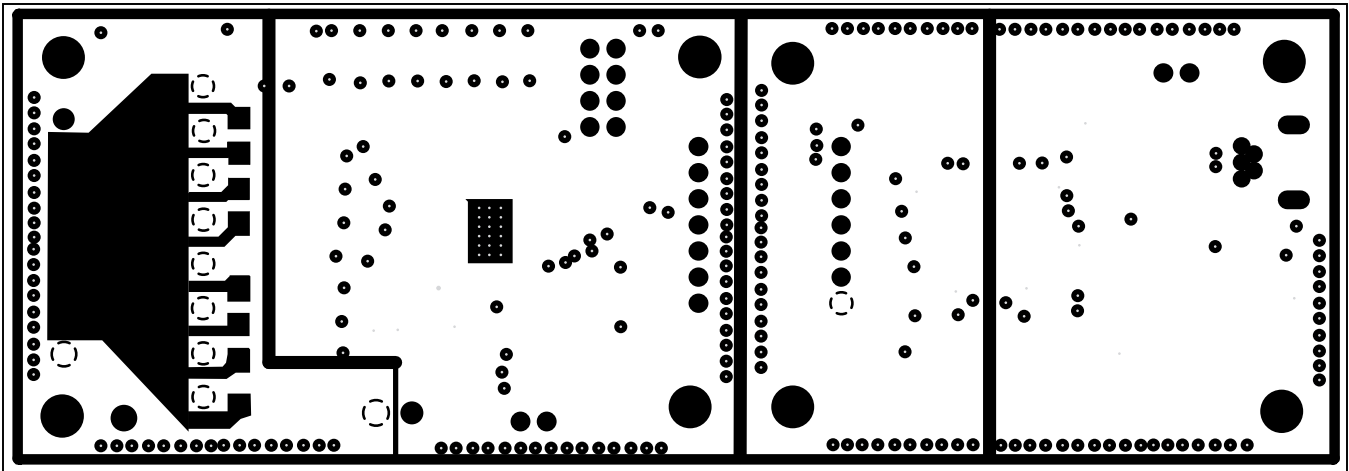

Figure 7. MAX31910/11 EV Kit PCB Layout—Internal Layer 2

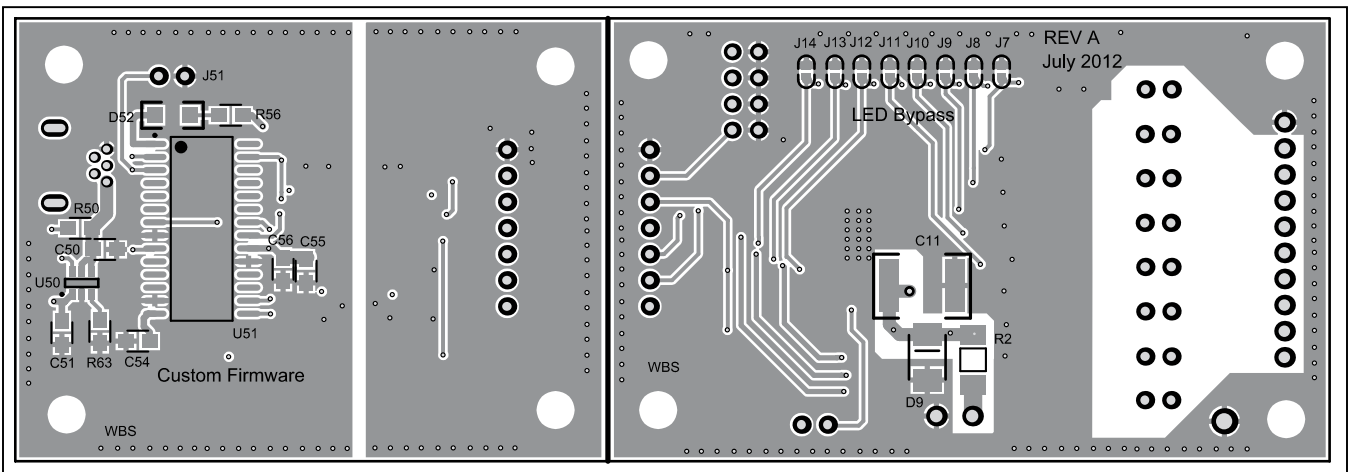

Figure 8. MAX31910/11 EV Kit PCB Layout—Bottom

MAX31910/11 Evaluation Kit

Evaluates: MAX31910 and MAX31911

Component List: MAX31910/11 EV Kit

DESIGNATION	QTY	DESCRIPTION
C1, C12	2	0.1 μ F X7R ceramic capacitors (0805) TDK CGJ4J2X7R1H104K
C2	1	4.7 μ F X7R ceramic capacitor (0805) TDK CGA4J1X7R1E475K
C3–C10	8	1nF, 60V ceramic capacitors (0805), do not populate
C11	1	10 μ F, 100V X7S ceramic capacitor (2220) TDK C5750X7S2A106M
D1–D8	8	LEDs (0805), do not populate
D9	1	36V, 600W zener diode ON Semiconductor 1SMB36AT3G
D10	1	Red LED (0805) Kingbright APT2012EC
R1	1	15k Ω \pm 1% resistor 1/8W (0805) Bourns CR0805-FX-1502ELF
R2	1	150 Ω \pm 5% resistor 1/3W MELF (0207) Vishay MMB02070C1500FB200
R3–R10	8	2.2k Ω \pm 1% resistor 1/4W MELF (0204) Vishay MMA02040C2201FB300

DESIGNATION	QTY	DESCRIPTION
R11	1	3.3k Ω \pm 5% resistor (0805) Bourns CR0805-FX-3301ELF
J1	1	2-position screw terminal, 3.5mm pitch Phoenix Contact 1984617
J2, J15–J22	9	1x2 header, 2.54mm pitch Molex 22-28-4020
J3	1	1x7 right-angle header, 2.54mm pitch Molex 22-28-8070
J5	1	10-position screw terminal, 2.5mm pitch TE Connectivity 1-282834-0
J6	1	2x4 header, 2.54mm pitch TE Connectivity 5-146256-4
J7–J14	8	Solder bridge
TP1	1	Black test point
U1	1	Industrial interface serializer (28 TSSOP-EP) Maxim MAX31910AUI+ or MAX31911AUI+

MAX31910/11 Evaluation Kit

Evaluates: MAX31910 and MAX31911

Component List: USB to SPI Dongle

DESIGNATION	QTY	DESCRIPTION
C50, C51	2	10 μ F X7R ceramic capacitors (0805) KEMET C0805C106K8RACTU
C53	1	22pF X7R ceramic capacitor (0805) KEMET C0805C220KBRACU
C54	1	220nF X7R ceramic capacitor (0805) TDK CGJ4J2X7R1H224K
C55	1	1 μ F X7R ceramic capacitor (0805) TDK C2012X7R1H105K
C56, C57, C58	3	0.1 μ F X7R ceramic capacitors (0805) TDK CGJ4J2X7R1H104K
D50, D51	2	Dual LEDs, red/green Kingbright APHB M2012SURKCGKC
D52	1	Schottky diode ROHM Semiconductor RB060M-30TR
R50, R62	2	560 Ω \pm 1% resistors (0805) Bourns CR0805-FX-5600ELF
R51, R52, R57	3	0 Ω \pm 5% resistors (0805) Bourns CR0805-J/-000ELF
R53	1	4.7k Ω \pm 1% resistor (0805) Bourns CR0805-FX-4701ELF
R54, R55	2	330 Ω \pm 1% resistors (0805) Bourns CR0805-FX-3300ELF

DESIGNATION	QTY	DESCRIPTION
R56	1	2.2k Ω \pm 1% resistor (0805) Bourns CR0805-FX-2201ELF
R58–R61	4	Resistors (0805), do not populate
R63	1	100k Ω \pm 1% resistor (0805) Bourns CR0805-FX-1003ELF
J50	1	5-pin female Mini-USB Molex 54819-0519
J51	1	Do not populate
J52	1	1x7 right-angle socket, 2.54mm pitch PPPC071LGBN-RC
U50	1	50mA to 600mA current-limit switch (SOT23-6) Maxim MAX4995AAUT+
U51	1	Microcontroller (28 SO) Microchip PIC18LF2550-I/SO
U52	1	4-channel digital isolator (16 SO, 300 mils) TI ISO7242M/C Do not populate
U53	1	6-channel digital isolator (16 SO, 150 mils) Maxim MAX14850ASE+
X50	1	48MHz, 5V oscillator (SMD) TXC 7W-48.000MAB-T

MAX31910/11 Evaluation Kit

Evaluates: MAX31910 and MAX31911

Ordering Information

PART	TYPE
MAX31910 EVKIT#	EV Kit
MAX31911 EVKIT#	EV Kit

#Denotes a RoHS-compliant device that may include lead that is exempt under the RoHS requirements.

MAX31910/11 Evaluation Kit

Evaluates: MAX31910 and MAX31911

Revision History

REVISION NUMBER	REVISION DATE	DESCRIPTION	PAGES CHANGED
0	9/12	Initial release	—



Maxim Integrated cannot assume responsibility for use of any circuitry other than circuitry entirely embodied in a Maxim Integrated product. No circuit patent licenses are implied. Maxim Integrated reserves the right to change the circuitry and specifications without notice at any time.

Maxim Integrated 160 Rio Robles, San Jose, CA 95134 USA 1-408-601-1000

13



Стандарт Электрон Связь

Мы молодая и активно развивающаяся компания в области поставок электронных компонентов. Мы поставляем электронные компоненты отечественного и импортного производства напрямую от производителей и с крупнейших складов мира.

Благодаря сотрудничеству с мировыми поставщиками мы осуществляем комплексные и плановые поставки широчайшего спектра электронных компонентов.

Собственная эффективная логистика и склад в обеспечивает надежную поставку продукции в точно указанные сроки по всей России.

Мы осуществляем техническую поддержку нашим клиентам и предпродажную проверку качества продукции. На все поставляемые продукты мы предоставляем гарантию .

Осуществляем поставки продукции под контролем ВП МО РФ на предприятия военно-промышленного комплекса России , а также работаем в рамках 275 ФЗ с открытием отдельных счетов в уполномоченном банке. Система менеджмента качества компании соответствует требованиям ГОСТ ISO 9001.

Минимальные сроки поставки, гибкие цены, неограниченный ассортимент и индивидуальный подход к клиентам являются основой для выстраивания долгосрочного и эффективного сотрудничества с предприятиями радиоэлектронной промышленности, предприятиями ВПК и научно-исследовательскими институтами России.

С нами вы становитесь еще успешнее!

Наши контакты:

Телефон: +7 812 627 14 35

Электронная почта: sales@st-electron.ru

Адрес: 198099, Санкт-Петербург,
Промышленная ул, дом № 19, литера Н,
помещение 100-Н Офис 331