

**3 Phase bridge
Trench + Field Stop IGBT®
Power Module**

**$V_{CES} = 600V$
 $I_C = 75A^* @ T_c = 80^\circ C$**

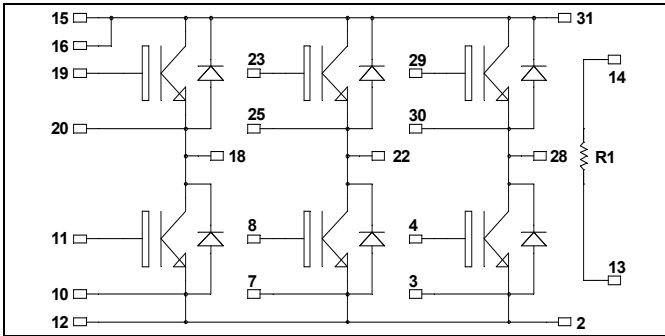

It is recommended to connect a decoupling capacitor between pins 31 & 2 to reduce switching overvoltages, if DC Power is connected between pins 15, 16 & 12. Pins 15 & 16 must be shorted together.

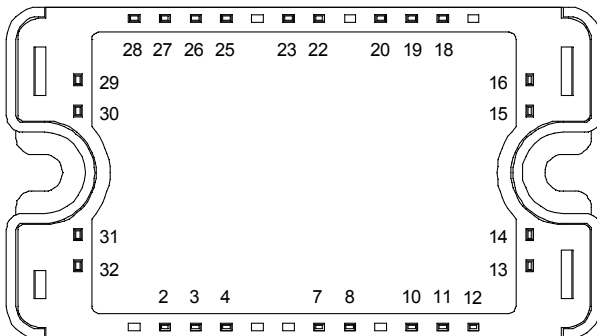

Application

- Motor control

Features

- Trench + Field Stop IGBT® Technology
 - Low voltage drop
 - Low tail current
 - Switching frequency up to 20 kHz
 - Soft recovery parallel diodes
 - Low diode VF
 - Low leakage current
 - RBSOA and SCSOA rated
- Kelvin emitter for easy drive
- Very low stray inductance
- High level of integration
- Internal thermistor for temperature monitoring

Benefits

- Outstanding performance at high frequency operation
- Direct mounting to heatsink (isolated package)
- Low junction to case thermal resistance
- Solderable terminals both for power and signal for easy PCB mounting
- Low profile
- RoHS compliant

Absolute maximum ratings

Symbol	Parameter	Max ratings	Unit
V_{CES}	Collector - Emitter Breakdown Voltage	600	V
I_C	Continuous Collector Current	$T_C = 25^\circ C$	100*
		$T_C = 80^\circ C$	75*
I_{CM}	Pulsed Collector Current	$T_C = 25^\circ C$	150
V_{GE}	Gate - Emitter Voltage	± 20	V
P_D	Maximum Power Dissipation	$T_C = 25^\circ C$	250
RBSOA	Reverse Bias Safe Operating Area	$T_J = 150^\circ C$	150A @ 550V

* Specification of IGBT device but output current must be limited to 40A at $T_c=80^\circ C$ and 65A at $T_c=25^\circ C$ not to exceed a connectors temperature greater than $120^\circ C$.

CAUTION: These Devices are sensitive to Electrostatic Discharge. Proper Handling Procedures Should Be Followed. See application note APT0502 on www.microsemi.com

All ratings @ $T_j = 25^\circ\text{C}$ unless otherwise specified

Electrical Characteristics

Symbol	Characteristic	Test Conditions	Min	Typ	Max	Unit
I_{CES}	Zero Gate Voltage Collector Current	$V_{GE} = 0V, V_{CE} = 600V$			250	μA
$V_{CE(sat)}$	Collector Emitter Saturation Voltage	$V_{GE} = 15V$ $I_C = 75A$		1.5 1.7	1.9	V
$V_{GE(th)}$	Gate Threshold Voltage	$V_{GE} = V_{CE}, I_C = 600\mu\text{A}$	5.0	5.8	6.5	V
I_{GES}	Gate – Emitter Leakage Current	$V_{GE} = 20V, V_{CE} = 0V$			600	nA

Dynamic Characteristics

Symbol	Characteristic	Test Conditions	Min	Typ	Max	Unit
C_{ies}	Input Capacitance	$V_{GE} = 0V$		4620		pF
C_{oes}	Output Capacitance	$V_{CE} = 25V$		300		
C_{res}	Reverse Transfer Capacitance	$f = 1\text{MHz}$		140		
$T_{d(on)}$	Turn-on Delay Time	Inductive Switching (25°C) $V_{GE} = \pm 15V$ $V_{Bus} = 300V$ $I_C = 75A$ $R_G = 4.7\Omega$		110		ns
T_r	Rise Time			45		
$T_{d(off)}$	Turn-off Delay Time			200		
T_f	Fall Time			40		
$T_{d(on)}$	Turn-on Delay Time	Inductive Switching (150°C) $V_{GE} = \pm 15V$ $V_{Bus} = 300V$ $I_C = 75A$ $R_G = 4.7\Omega$		120		ns
T_r	Rise Time			50		
$T_{d(off)}$	Turn-off Delay Time			250		
T_f	Fall Time			60		
E_{on}	Turn-on Switching Energy	$V_{GE} = \pm 15V$ $V_{Bus} = 300V$ $I_C = 75A$	$T_j = 25^\circ\text{C}$	0.35		mJ
			$T_j = 150^\circ\text{C}$	0.6		
E_{off}	Turn-off Switching Energy	$R_G = 4.7\Omega$	$T_j = 25^\circ\text{C}$	2.2		mJ
			$T_j = 150^\circ\text{C}$	2.6		

Reverse diode ratings and characteristics

Symbol	Characteristic	Test Conditions	Min	Typ	Max	Unit
V_{RRM}	Maximum Peak Repetitive Reverse Voltage		600			V
I_{RM}	Maximum Reverse Leakage Current	$V_R = 600V$			250 500	μA
I_F	DC Forward Current			50		A
V_F	Diode Forward Voltage	$I_F = 50A$ $V_{GE} = 0V$		1.6 1.5	2	V
t_{rr}	Reverse Recovery Time	$I_F = 50A$ $V_R = 300V$ $di/dt = 1800A/\mu\text{s}$	$T_j = 25^\circ\text{C}$	100		ns
			$T_j = 150^\circ\text{C}$	150		
Q_{rr}	Reverse Recovery Charge		$T_j = 25^\circ\text{C}$	2.6		μC
			$T_j = 150^\circ\text{C}$	5.4		
E_r	Reverse Recovery Energy		$T_j = 25^\circ\text{C}$	0.6		mJ
		$T_j = 150^\circ\text{C}$	1.2			

Temperature sensor NTC (see application note APT0406 on www.microsemi.com for more information).

Symbol	Characteristic	Min	Typ	Max	Unit
R ₂₅	Resistance @ 25°C		50		kΩ
B _{25/85}	T ₂₅ = 298.15 K		3952		K

$$R_T = \frac{R_{25}}{\exp\left[B_{25/85}\left(\frac{1}{T_{25}} - \frac{1}{T}\right)\right]}$$

T: Thermistor temperature
 R_T: Thermistor value at T

Thermal and package characteristics

Symbol	Characteristic	Min	Typ	Max	Unit	
R _{thJC}	Junction to Case Thermal Resistance	IGBT		0.6	°C/W	
		Diode		1.42		
V _{ISOL}	RMS Isolation Voltage, any terminal to case t=1 min, I isol<1mA, 50/60Hz	2500			V	
T _J	Operating junction temperature range	-40		175	°C	
T _{STG}	Storage Temperature Range	-40		125		
T _C	Operating Case Temperature	-40		100		
Torque	Mounting torque	To heatsink	M4	2.5	4.7	N.m
Wt	Package Weight				110	g

SP3 Package outline (dimensions in mm)



See application note 1901 - Mounting Instructions for SP3 Power Modules on www.microsemi.com

Typical Performance Curve

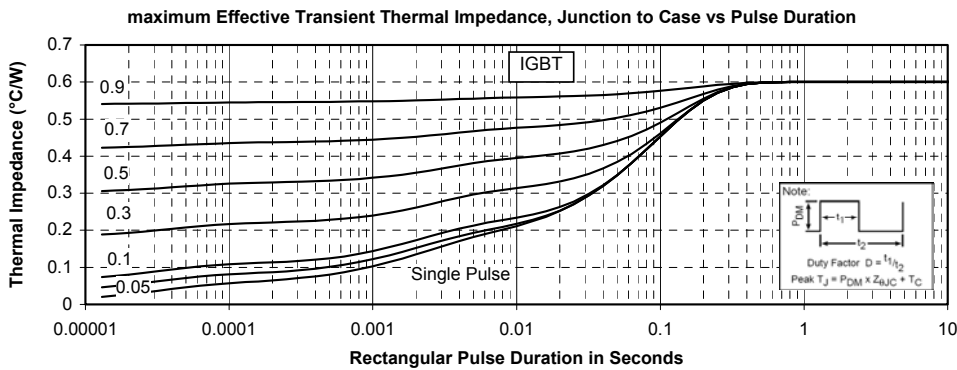
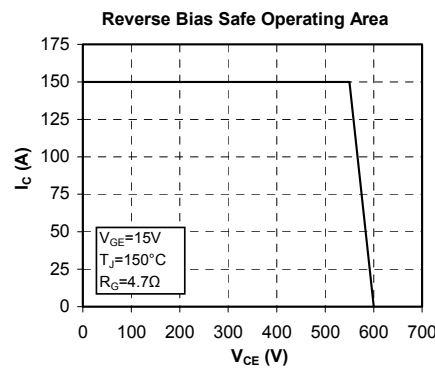
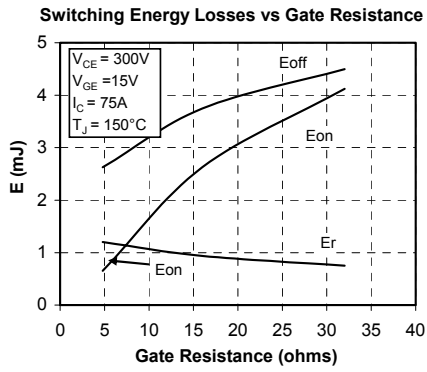
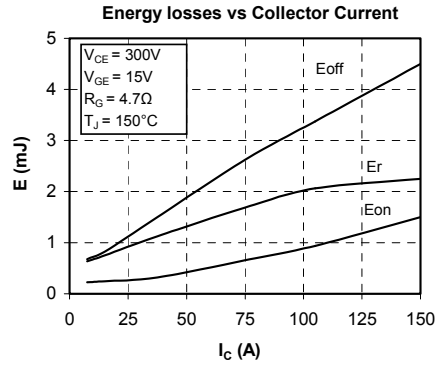
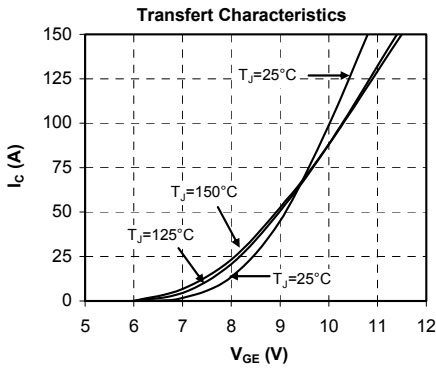
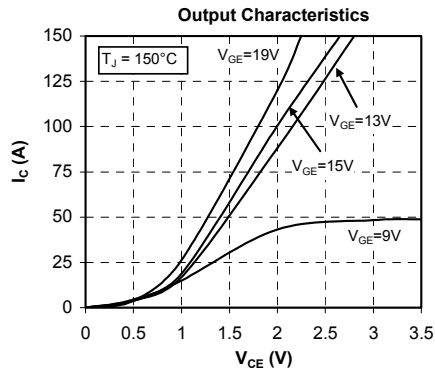
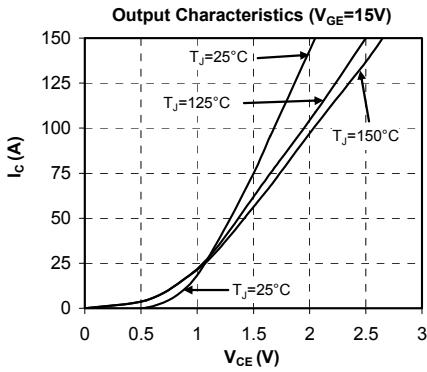

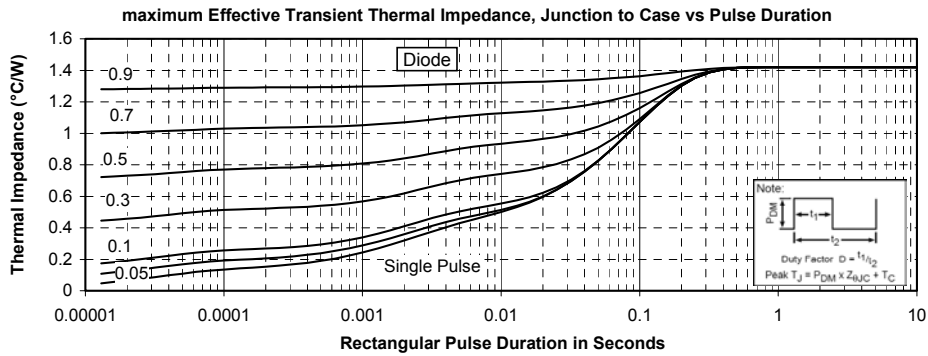
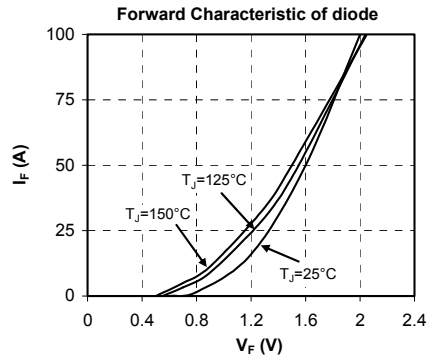
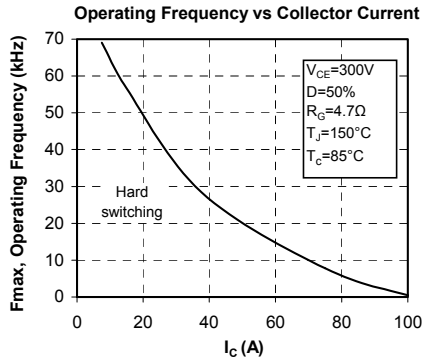

Microsemi reserves the right to change, without notice, the specifications and information contained herein

Microsemi's products are covered by one or more of U.S. patents 4,895,810 5,045,903 5,089,434 5,182,234 5,019,522 5,262,336 6,503,786 5,256,583 4,748,103 5,283,202 5,231,474 5,434,095 5,528,058 and foreign patents. U.S. and Foreign patents pending. All Rights Reserved.



Стандарт Электрон Связь

Мы молодая и активно развивающаяся компания в области поставок электронных компонентов. Мы поставляем электронные компоненты отечественного и импортного производства напрямую от производителей и с крупнейших складов мира.

Благодаря сотрудничеству с мировыми поставщиками мы осуществляем комплексные и плановые поставки широчайшего спектра электронных компонентов.

Собственная эффективная логистика и склад в обеспечивает надежную поставку продукции в точно указанные сроки по всей России.

Мы осуществляем техническую поддержку нашим клиентам и предпродажную проверку качества продукции. На все поставляемые продукты мы предоставляем гарантию .

Осуществляем поставки продукции под контролем ВП МО РФ на предприятия военно-промышленного комплекса России , а также работаем в рамках 275 ФЗ с открытием отдельных счетов в уполномоченном банке. Система менеджмента качества компании соответствует требованиям ГОСТ ISO 9001.

Минимальные сроки поставки, гибкие цены, неограниченный ассортимент и индивидуальный подход к клиентам являются основой для выстраивания долгосрочного и эффективного сотрудничества с предприятиями радиоэлектронной промышленности, предприятиями ВПК и научно-исследовательскими институтами России.

С нами вы становитесь еще успешнее!

Наши контакты:

Телефон: +7 812 627 14 35

Электронная почта: sales@st-electron.ru

Адрес: 198099, Санкт-Петербург,
Промышленная ул, дом № 19, литера Н,
помещение 100-Н Офис 331