

## LR2-O-90

~10° x 40° oval beam optimized for LUXEON Rebel ES. 14.8 mm high assembly with installation tape. Variant with beam direction rotated 90°.

### TECHNICAL SPECIFICATIONS:

Dimensions	Ø 21.6 mm
Height	14.8 mm
Fastening	tape, pin
ROHS compliant	yes 



### MATERIAL SPECIFICATIONS:

Component	Type	Material	Colour	Finish
LXP2-O-90	Single lens	PMMA	clear	
LR2-ES-LH1-HLD	Holder	PC	white	
HEIDI-TAPE	Tape	PU tape	black	

### ORDERING INFORMATION:

Component		Qty in box	MOQ	MPQ	Box weight (kg)
CA12629_LR2-O-90	Single lens	1680	336	112	10.0
» Box size: 480 x 280 x 300 mm					

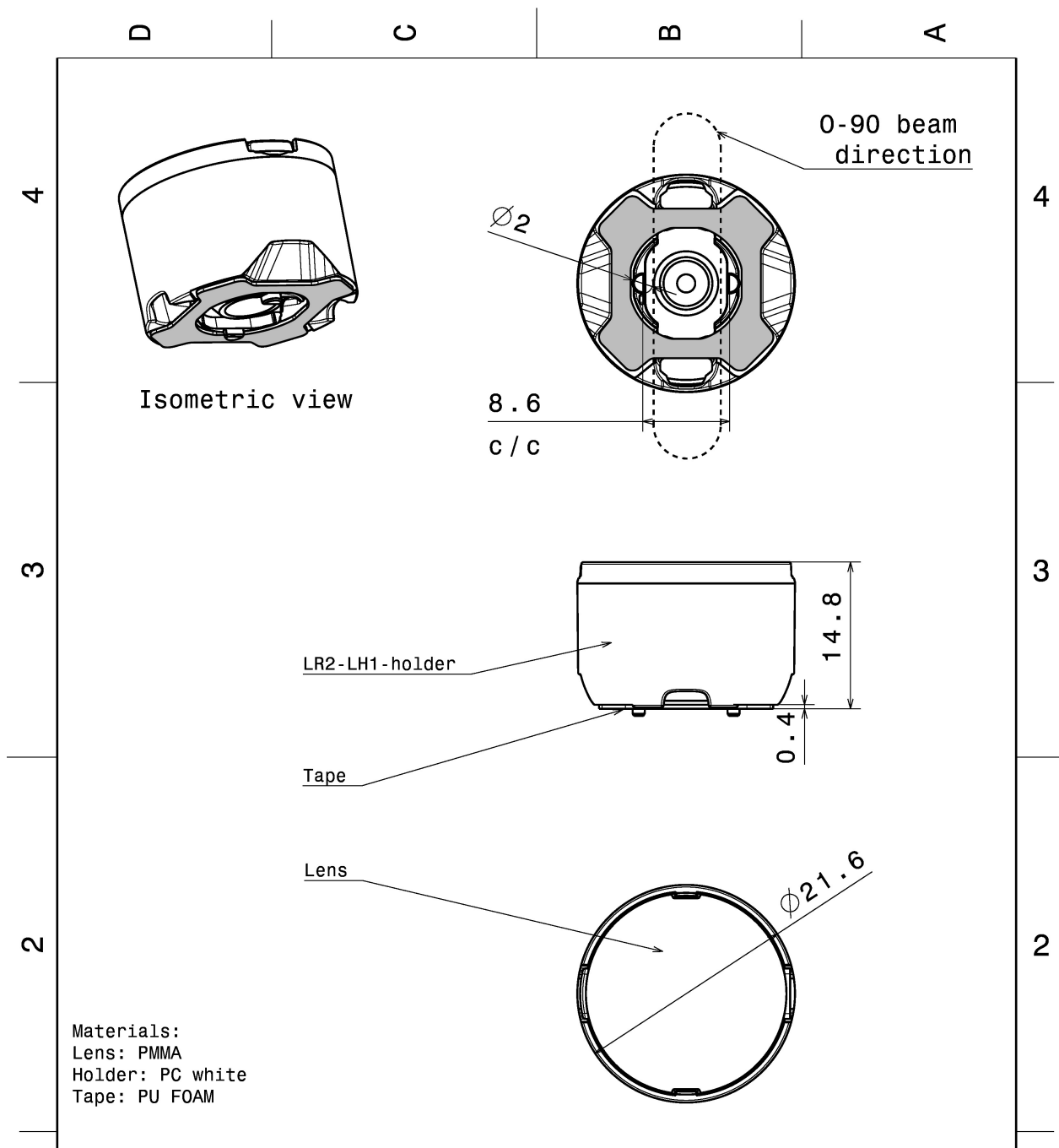

This drawing is our property. It can't be reproduced or communicated without our written agreement.		<b>LEDiL</b>		LediL Oy Salorankatu 10 FIN-24100 SALO Finland	
DRAWING TITLE		<b>Datasheet LR2-ES series</b>			
DRAWN BY ah	DATE 27.1.2012	SIZE <b>A4</b>	DRAWING NUMBER		REV <b>3</b>
CHECKED BY sn	DATE 27.1.2012	SCALE 1:1	WEIGHT (g)	SHEET 1/1	
DESIGNED BY pl	DATE 27.08.2010				

#### PHOTOMETRIC DATA (MEASURED):



LED XP-L HD  
 FWHM 16.0 + 39.0°  
 Efficiency 89 %  
 Peak intensity 3.3 cd/lm  
 LEDs/each optic 1  
 Light colour White  
 Required components:

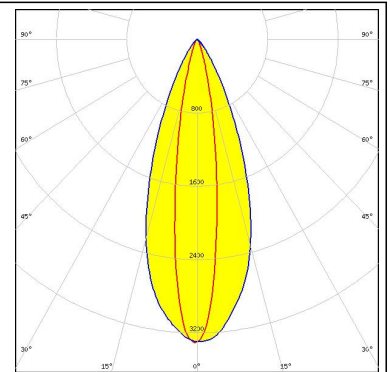
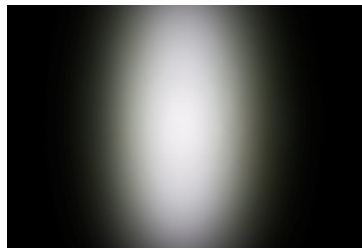

LED LUXEON Rebel ES  
 FWHM 13.0 + 36.0°  
 Efficiency 92 %  
 Peak intensity 4.7 cd/lm  
 LEDs/each optic 1  
 Light colour White  
 Required components:

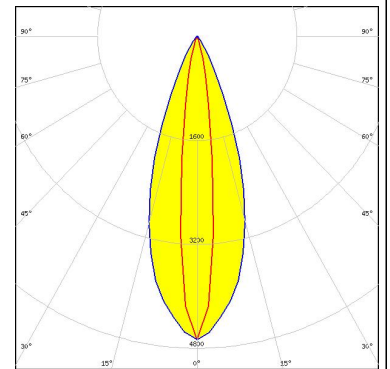
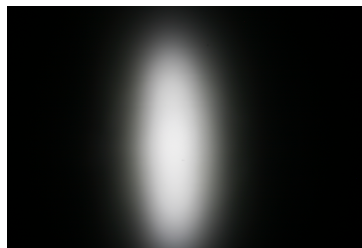



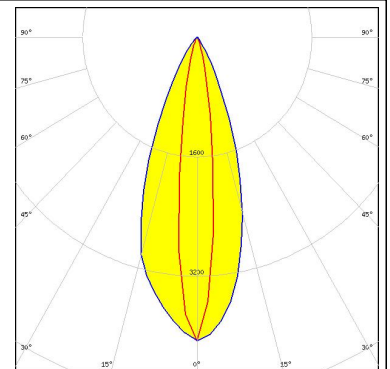

LED LUXEON T  
 FWHM 14.0 + 39.0°  
 Efficiency 88 %  
 Peak intensity 4.1 cd/lm  
 LEDs/each optic 1  
 Light colour White  
 Required components:

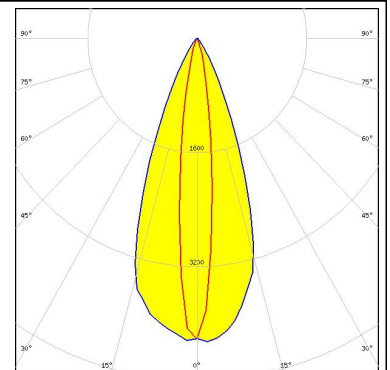
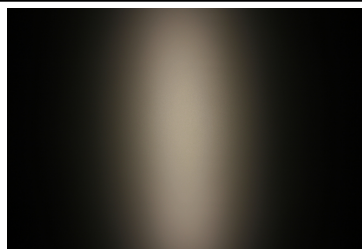

LED LUXEON TX  
 FWHM 14.0 + 41.0°  
 Efficiency 90 %  
 Peak intensity 4.2 cd/lm  
 LEDs/each optic 1  
 Light colour White  
 Required components:

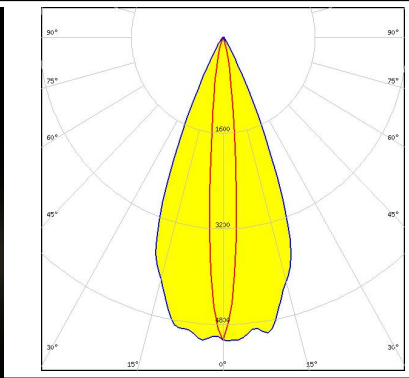

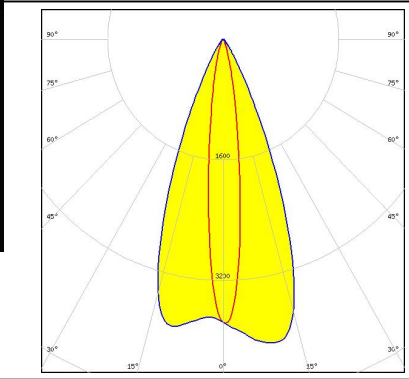
**PHOTOMETRIC DATA (MEASURED):**

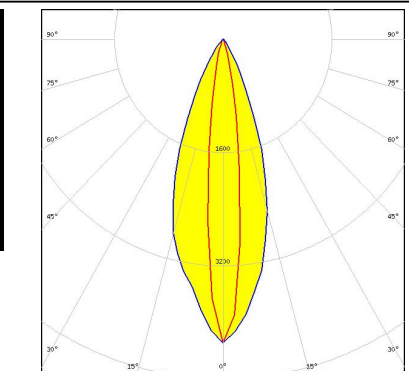
<p><b>LUMILEDS</b></p> <p>LED LUXEON Z ES            FWHM 10.0 + 40.0°            Efficiency 89 %            Peak intensity 6 cd/lm            LEDs/each optic 1            Light colour White            Required components:</p>		
<p><b>NICHIA</b></p> <p>LED NVSxx19B/NVSxx19C            FWHM 13.0 + 43.0°            Efficiency 94 %            Peak intensity 4.1 cd/lm            LEDs/each optic 1            Light colour White            Required components:</p>		
<p><b>OSRAM</b> Opto Semiconductors</p> <p>LED OSOLON Square EC            FWHM 14.0 + 34.0°            Efficiency 88 %            Peak intensity 4.3 cd/lm            LEDs/each optic 1            Light colour White            Required components:</p>		

#### PHOTOMETRIC DATA (SIMULATED):



LED XP-G3  
 FWHM 15.0 + 41.0°  
 Efficiency 93 %  
 Peak intensity 3.8 cd/lm  
 LEDs/each optic 1  
 Light colour White  
 Required components:

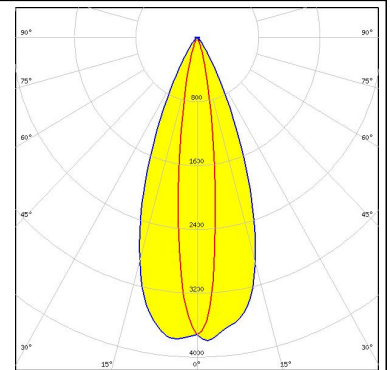

LED LUXEON C  
 FWHM 9.6 + 44.0°  
 Efficiency 94 %  
 Peak intensity 5.5 cd/lm  
 LEDs/each optic 1  
 Light colour White  
 Required components:

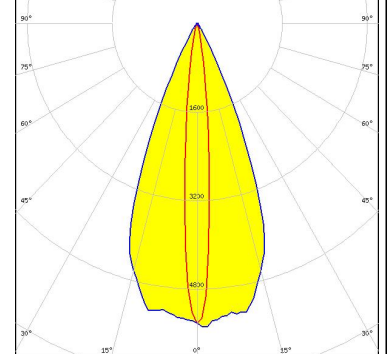

LED LUXEON V2  
 FWHM 13.0 + 40.0°  
 Efficiency 93 %  
 Peak intensity 4.7 cd/lm  
 LEDs/each optic 1  
 Light colour White  
 Required components:

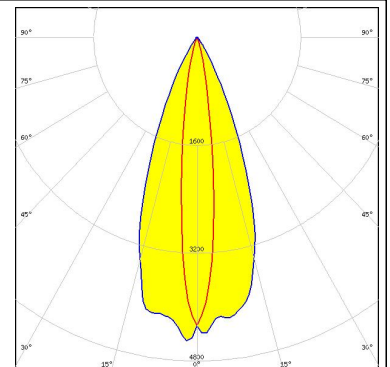

LED LUXEON Z  
 FWHM 9.0 + 45.0°  
 Efficiency 94 %  
 Peak intensity 5.7 cd/lm  
 LEDs/each optic 1  
 Light colour White  
 Required components:

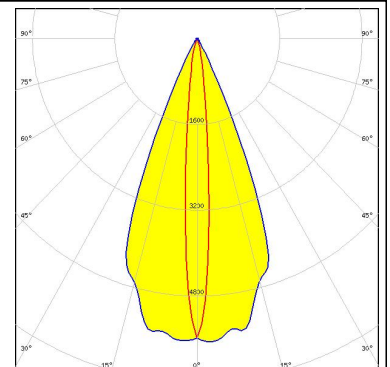

## PHOTOMETRIC DATA (SIMULATED):

**OSRAM**  
Opto Semiconductors

LED	OSLON Square CSSRM2/CSSRM3
FWHM	12.0 + 42.0°
Efficiency	94 %
Peak intensity	4.4 cd/lm
LEDs/each optic	1
Light colour	White
Required components:	

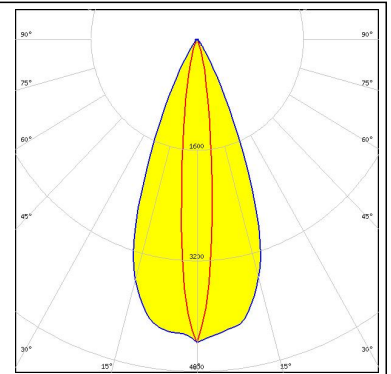

### GENERAL INFORMATION:

NOTE: The typical beam angle will be changed by different color, chip size and chip position tolerance. The typical total beam angle is the full angle measured where the luminous intensity is half of the peak value.

### MATERIALS:

As part of our continuous research and improvement processes, and to ensure the best possible quality and availability of our products, LEDiL reserves the right to change material grades without notice.

### PRODUCT DATA USER AGREEMENT AND DISCLAIMER:

The measured data in the provided downloadable LEDiL Product Datasheets and Mechanical 2D-Drawings is rounded and provided as reference for planning. LEDiL Oy's optical specifications have been verified by conducting performance testing of the products in accordance with the company's quality system. The reported data are averaged results of multiple measurements with typical variation. LEDiL Oy reserves the right to without prior notification make changes and improvements to its products.

LEDiL Oy assumes neither warranty, nor guarantee nor any other liability of any kind for the contents and correctness of the provided data. The provided data has been generated with highest diligence but the provided data may in reality not represent the complete possible variation range of all intrinsic parameters. Therefore, in certain cases a deviation from the provided data could occur.

LEDiL Oy reserves the right to undertake technical changes of its products without further notification which could lead to changes in the provided data. LEDiL Oy assumes no liability of any kind for the possible deviation from any provided data or any other damage resulting from the usage of the provided data.

The user agrees to this disclaimer and user agreement with the download or usage of the provided files.

#### LEDiL Oy

Joensuunkatu 13  
FI-24240 SALO  
Finland

#### LEDiL Inc.

228 West Page Street  
Suite D  
Sycamore IL 60178  
USA

#### Local sales and technical support

[www.ledil.com/  
where\\_to\\_buy](http://www.ledil.com/where_to_buy)

#### Shipping locations

Salo, Finland  
Hong Kong, China

#### Distribution Partners

[www.ledil.com/  
where\\_to\\_buy](http://www.ledil.com/where_to_buy)



## Стандарт Электрон Связь

Мы молодая и активно развивающаяся компания в области поставок электронных компонентов. Мы поставляем электронные компоненты отечественного и импортного производства напрямую от производителей и с крупнейших складов мира.

Благодаря сотрудничеству с мировыми поставщиками мы осуществляем комплексные и плановые поставки широчайшего спектра электронных компонентов.

Собственная эффективная логистика и склад в обеспечивает надежную поставку продукции в точно указанные сроки по всей России.

Мы осуществляем техническую поддержку нашим клиентам и предпродажную проверку качества продукции. На все поставляемые продукты мы предоставляем гарантию .

Осуществляем поставки продукции под контролем ВП МО РФ на предприятия военно-промышленного комплекса России , а также работаем в рамках 275 ФЗ с открытием отдельных счетов в уполномоченном банке. Система менеджмента качества компании соответствует требованиям ГОСТ ISO 9001.

Минимальные сроки поставки, гибкие цены, неограниченный ассортимент и индивидуальный подход к клиентам являются основой для выстраивания долгосрочного и эффективного сотрудничества с предприятиями радиоэлектронной промышленности, предприятиями ВПК и научно-исследовательскими институтами России.

С нами вы становитесь еще успешнее!

### Наши контакты:

**Телефон:** +7 812 627 14 35

**Электронная почта:** [sales@st-electron.ru](mailto:sales@st-electron.ru)

**Адрес:** 198099, Санкт-Петербург,  
Промышленная ул, дом № 19, литера Н,  
помещение 100-Н Офис 331