

IGBT

IGBT with integrated diode in packages offering space saving advantage

IKD06N60RF

TRENCHSTOP™ RC-Series for hard switching applications up to 30 kHz

Data sheet

IGBT with integrated diode in packages offering space saving advantage

Features:

TRENCHSTOP™ Reverse Conducting (RC) technology for 600V applications offering

- Optimized Eon, Eoff and Qrr for low switching losses
- Operating range of 4 to 30kHz
- Smooth switching performance leading to low EMI levels
- Very tight parameter distribution
- Maximum junction temperature 175°C
- Short circuit capability of 5μs
- Best in class current versus package size performance
- Qualified according to JEDEC for target applications
- Pb-free lead plating; RoHS compliant (solder temperature 260°C, MSL1)

Complete product spectrum and PSpice Models:
<http://www.infineon.com/igbt/>

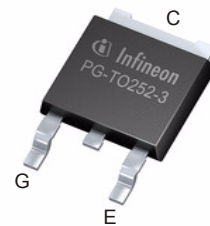
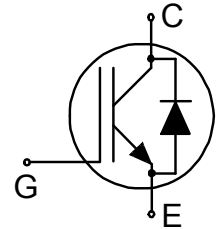

Applications:

Domestic and industrial drives:

- Compressors
- Pumps
- Fans



Key Performance and Package Parameters

Type	V _{CE}	I _C	V _{CEsat} , T _{vj} =25°C	T _{vjmax}	Marking	Package
IKD06N60RF	600V	6A	2.2V	175°C	K06R60F	PG-TO252-3



Table of Contents

Description 2

Table of Contents 3

Maximum ratings 4

Thermal Resistance 4

Electrical Characteristics 5

Electrical Characteristics diagrams 8

Package Drawing 15

Testing Conditions 16

Revision History 17

Disclaimer 17

Maximum ratings

Parameter	Symbol	Value	Unit
Collector-emitter voltage	V_{CE}	600	V
DC collector current, limited by T_{vjmax} $T_C = 25^\circ\text{C}$ $T_C = 100^\circ\text{C}$	I_C	12.0 6.0	A
Pulsed collector current, t_p limited by T_{vjmax}	I_{Cpuls}	18.0	A
Turn off safe operating area $V_{CE} \leq 600\text{V}$, $T_{vj} \leq 175^\circ\text{C}$	-	18.0	A
Diode forward current, limited by T_{vjmax} $T_C = 25^\circ\text{C}$ $T_C = 100^\circ\text{C}$	I_F	12.0 6.0	A
Diode pulsed current, t_p limited by T_{vjmax}	I_{Fpuls}	18.0	A
Gate-emitter voltage	V_{GE}	± 20	V
Short circuit withstand time $V_{GE} = 15.0\text{V}$, $V_{CC} \leq 400\text{V}$ Allowed number of short circuits < 1000 Time between short circuits: $\geq 1.0\text{s}$ $T_{vj} = 150^\circ\text{C}$	t_{SC}	5	μs
Power dissipation $T_C = 25^\circ\text{C}$	P_{tot}	100.0	W
Operating junction temperature	T_{vj}	-40...+175	$^\circ\text{C}$
Storage temperature	T_{stg}	-55...+175	$^\circ\text{C}$
Soldering temperature, reflow soldering (MSL1 according to JEDEC J-STA-020)		260	$^\circ\text{C}$

Thermal Resistance

Parameter	Symbol	Conditions	Max. Value	Unit
Characteristic				
IGBT thermal resistance, ¹⁾ junction - case	$R_{th(j-c)}$		1.50	K/W
Diode thermal resistance, ²⁾ junction - case	$R_{th(j-c)}$		3.60	K/W
Thermal resistance, min. footprint junction - ambient	$R_{th(j-a)}$		75	K/W
Thermal resistance, 6cm ² Cu on PCB junction - ambient	$R_{th(j-a)}$		50	K/W

¹⁾ R_{th}/Z_{th} based on single cooling pulse. Please be aware that a correct R_{th} measurement of the IGBT, is not possible using a thermocouple.

²⁾ R_{th}/Z_{th} based on single cooling pulse. Please be aware that a correct R_{th} measurement of the Diode, is not possible using a thermocouple.

Electrical Characteristic, at $T_{vj} = 25^{\circ}\text{C}$, unless otherwise specified

Parameter	Symbol	Conditions	Value			Unit
			min.	typ.	max.	
Static Characteristic						
Collector-emitter breakdown voltage	$V_{(BR)CES}$	$V_{GE} = 0\text{V}, I_C = 0.20\text{mA}$	600	-	-	V
Collector-emitter saturation voltage	V_{CEsat}	$V_{GE} = 15.0\text{V}, I_C = 6.0\text{A}$ $T_{vj} = 25^{\circ}\text{C}$ $T_{vj} = 175^{\circ}\text{C}$	- -	2.20 2.30	2.50 -	V
Diode forward voltage	V_F	$V_{GE} = 0\text{V}, I_F = 6.0\text{A}$ $T_{vj} = 25^{\circ}\text{C}$ $T_{vj} = 175^{\circ}\text{C}$	- -	2.10 2.00	2.40	V
Gate-emitter threshold voltage	$V_{GE(th)}$	$I_C = 0.11\text{mA}, V_{CE} = V_{GE}$	4.3	5.0	5.7	V
Zero gate voltage collector current ¹⁾	I_{CES}	$V_{CE} = 600\text{V}, V_{GE} = 0\text{V}$ $T_{vj} = 25^{\circ}\text{C}$ $T_{vj} = 175^{\circ}\text{C}$	- -	- -	40.0 1000.0	μA
Gate-emitter leakage current	I_{GES}	$V_{CE} = 0\text{V}, V_{GE} = 20\text{V}$	-	-	100	nA
Transconductance	g_{fs}	$V_{CE} = 20\text{V}, I_C = 6.0\text{A}$	-	2.9	-	S
Integrated gate resistor	r_G			none		Ω

Electrical Characteristic, at $T_{vj} = 25^{\circ}\text{C}$, unless otherwise specified

Parameter	Symbol	Conditions	Value			Unit
			min.	typ.	max.	
Dynamic Characteristic						
Input capacitance	C_{ies}	$V_{CE} = 25\text{V}, V_{GE} = 0\text{V}, f = 1\text{MHz}$	-	470	-	pF
Output capacitance	C_{oes}		-	24	-	
Reverse transfer capacitance	C_{res}		-	14	-	
Gate charge	Q_G	$V_{CC} = 480\text{V}, I_C = 6.0\text{A},$ $V_{GE} = 15\text{V}$	-	48.0	-	nC
Internal emitter inductance measured 5mm (0.197 in.) from case	L_E		-	7.0	-	nH
Short circuit collector current Max. 1000 short circuits Time between short circuits: $\geq 1.0\text{s}$	$I_{C(SC)}$	$V_{GE} = 15.0\text{V}, V_{CC} \leq 400\text{V},$ $t_{SC} \leq 5\mu\text{s}$ $T_{vj} = 25^{\circ}\text{C}$	-	46	-	A

¹⁾ Not subject to production test - verified by design/characterization

Switching Characteristic, Inductive Load, at $T_{vj} = 25^{\circ}\text{C}$

Parameter	Symbol	Conditions	Value			Unit
			min.	typ.	max.	
IGBT Characteristic						
Turn-on delay time	$t_{d(on)}$	$T_{vj} = 25^{\circ}\text{C}$, $V_{CC} = 400\text{V}$, $I_C = 6.0\text{A}$, $V_{GE} = 0.0/15.0\text{V}$, $r_G = 23.0\Omega$, $L_{\sigma} = 50\text{nH}$, $C_{\sigma} = 30\text{pF}$ L_{σ} , C_{σ} from Fig. E	-	7	-	ns
Rise time	t_r		-	8	-	ns
Turn-off delay time	$t_{d(off)}$		-	106	-	ns
Fall time	t_f		-	22	-	ns
Turn-on energy	E_{on}		-	0.09	-	mJ
Turn-off energy	E_{off}		-	0.09	-	mJ
Total switching energy	E_{ts}		-	0.18	-	mJ

Diode Characteristic, at $T_{vj} = 25^{\circ}\text{C}$

Diode reverse recovery time	t_{rr}	$T_{vj} = 25^{\circ}\text{C}$, $V_R = 400\text{V}$, $I_F = 6.0\text{A}$, $di_F/dt = 770\text{A}/\mu\text{s}$	-	48	-	ns
Diode reverse recovery charge	Q_{rr}		-	0.16	-	μC
Diode peak reverse recovery current	I_{rrm}		-	7.4	-	A
Diode peak rate of fall of reverse recovery current during t_b	di_{rr}/dt		-	-195	-	A/ μs

Switching Characteristic, Inductive Load, at $T_{vj} = 175^{\circ}\text{C}$

Parameter	Symbol	Conditions	Value			Unit
			min.	typ.	max.	
IGBT Characteristic						
Turn-on delay time	$t_{d(on)}$	$T_{vj} = 175^{\circ}\text{C}$, $V_{CC} = 400\text{V}$, $I_C = 6.0\text{A}$, $V_{GE} = 0.0/15.0\text{V}$, $r_G = 23.0\Omega$, $L_{\sigma} = 50\text{nH}$, $C_{\sigma} = 30\text{pF}$ L_{σ} , C_{σ} from Fig. E	-	8	-	ns
Rise time	t_r		-	8	-	ns
Turn-off delay time	$t_{d(off)}$		-	115	-	ns
Fall time	t_f		-	35	-	ns
Turn-on energy	E_{on}		-	0.15	-	mJ
Turn-off energy	E_{off}		-	0.13	-	mJ
Total switching energy	E_{ts}		-	0.28	-	mJ

Diode Characteristic, at $T_{vj} = 175^{\circ}\text{C}$

Diode reverse recovery time	t_{rr}	$T_{vj} = 175^{\circ}\text{C}$, $V_R = 400\text{V}$, $I_F = 6.0\text{A}$, $di_F/dt = 770\text{A}/\mu\text{s}$	-	74	-	ns
Diode reverse recovery charge	Q_{rr}		-	0.34	-	μC
Diode peak reverse recovery current	I_{rrm}		-	10.3	-	A
Diode peak rate of fall of reverse recovery current during t_b	di_{rr}/dt		-	-177	-	A/ μs

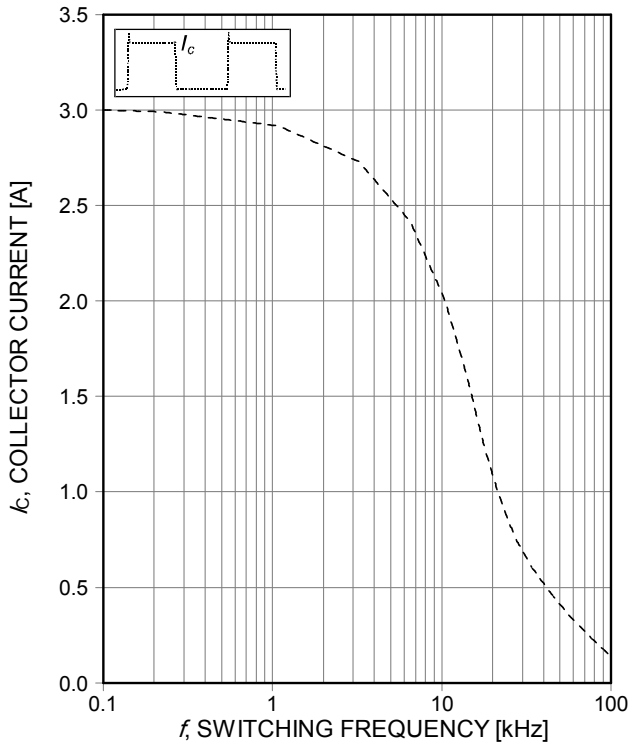

Figure 1. Collector current as a function of switching frequency
 ($T_{vj} \leq 175^\circ\text{C}$, $T_a = 55^\circ\text{C}$, $D = 0.5$, $V_{CE} = 400\text{V}$,
 $V_{GE} = 15/0\text{V}$, $r_G = 23\Omega$, PCB mounting,
 $6\text{cm}^2\text{Cu}$, $P_{tot} = 2,4\text{W}$)

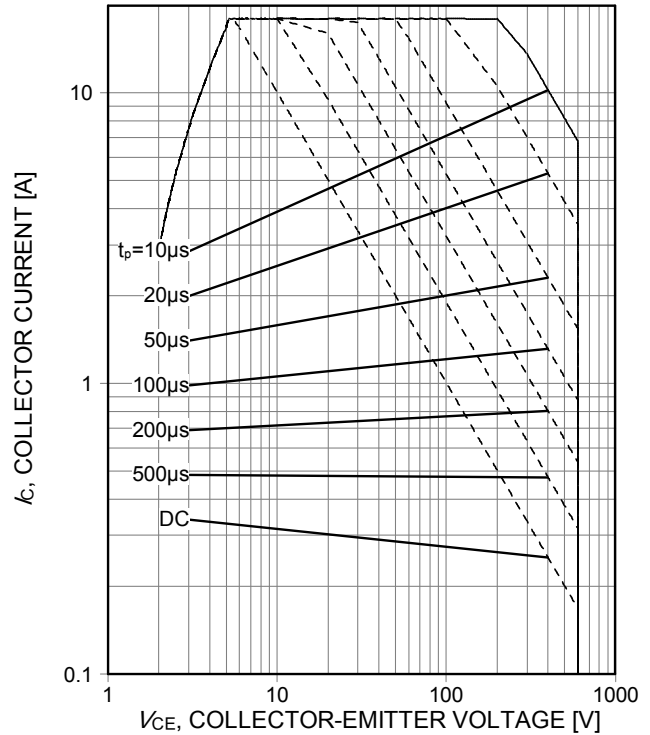

Figure 2. Forward bias safe operating area
 ($D = 0$, $T_C = 25^\circ\text{C}$, $T_{vj} \leq 175^\circ\text{C}$; $V_{GE} = 15\text{V}$)

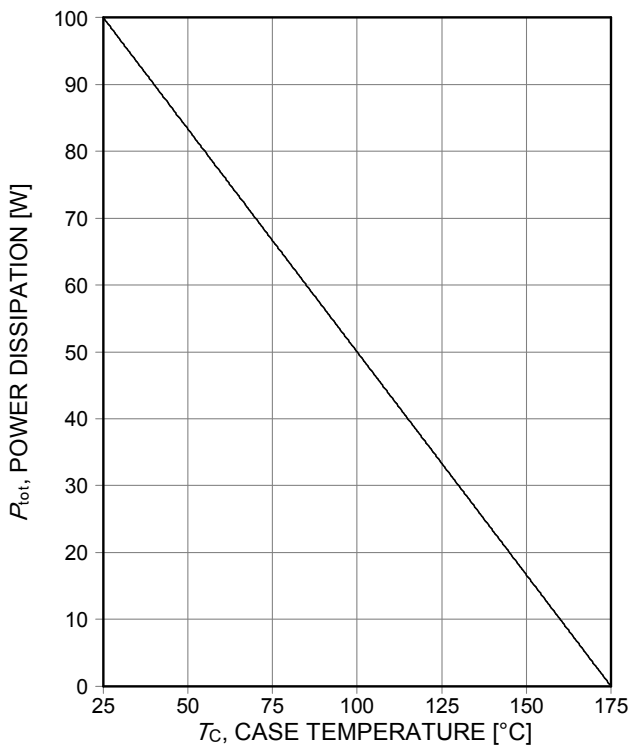

Figure 3. Power dissipation as a function of case temperature
 ($T_{vj} \leq 175^\circ\text{C}$)

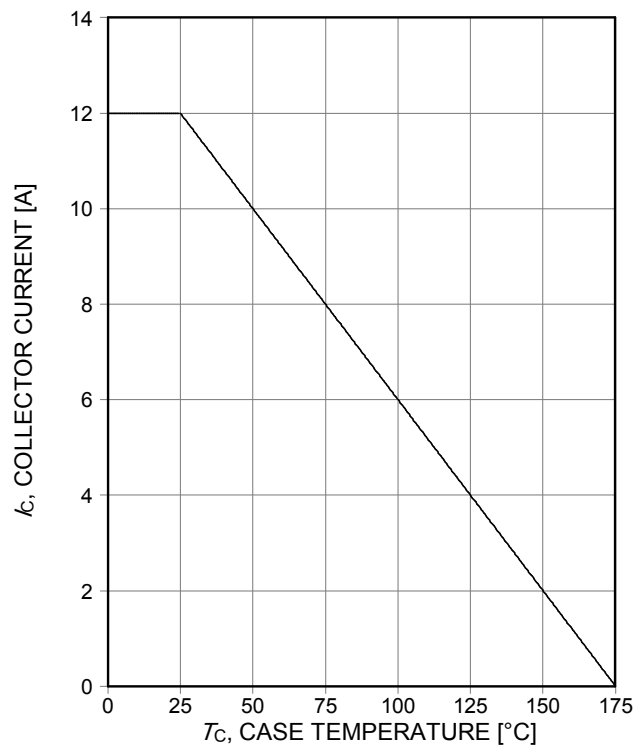

Figure 4. Collector current as a function of case temperature
 ($V_{GE} \geq 15\text{V}$, $T_{vj} \leq 175^\circ\text{C}$)

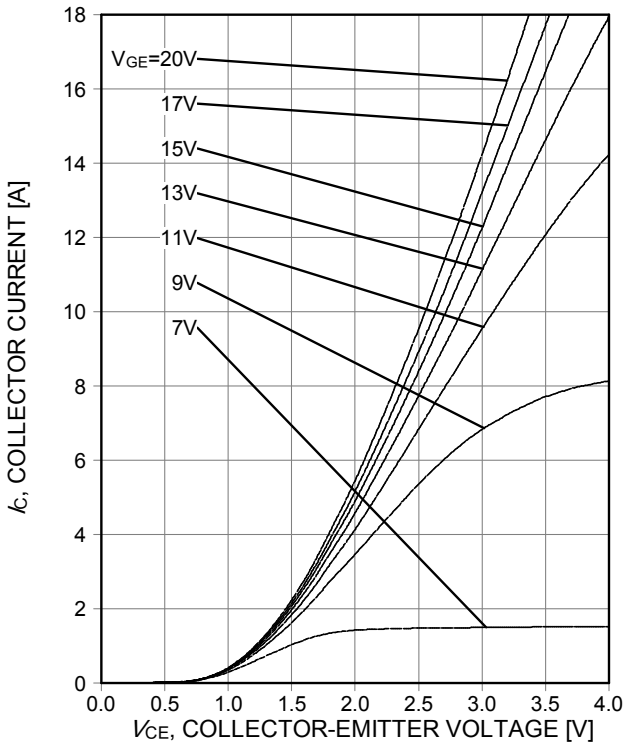

Figure 5. Typical output characteristic ($T_{vj}=25^{\circ}\text{C}$)

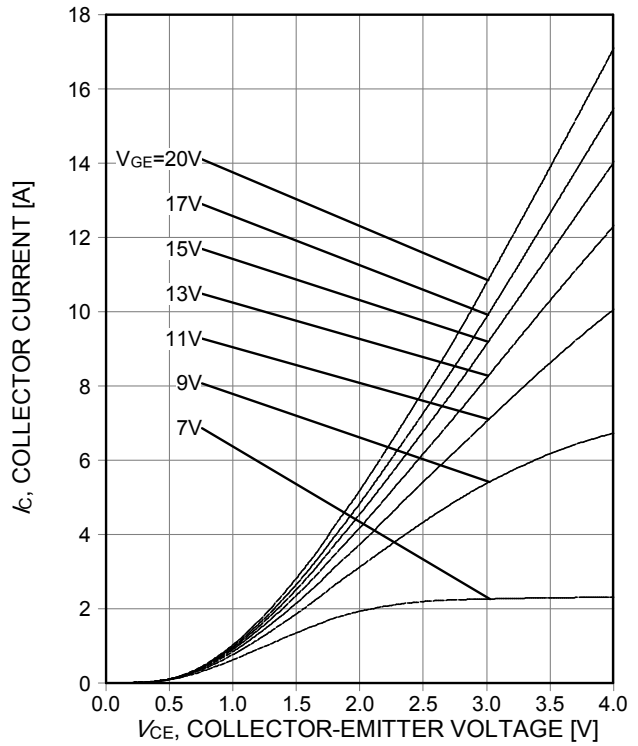

Figure 6. Typical output characteristic ($T_{vj}=175^{\circ}\text{C}$)

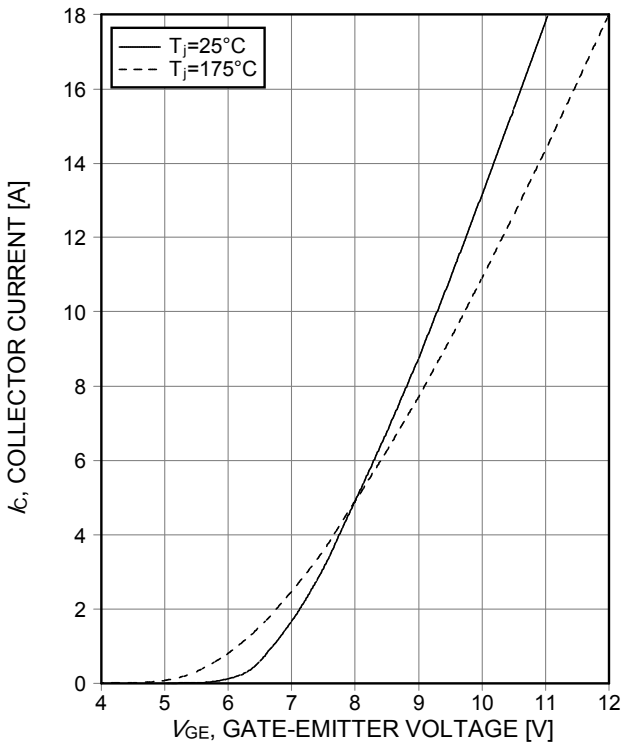

Figure 7. Typical transfer characteristic ($V_{ce}=10\text{V}$)

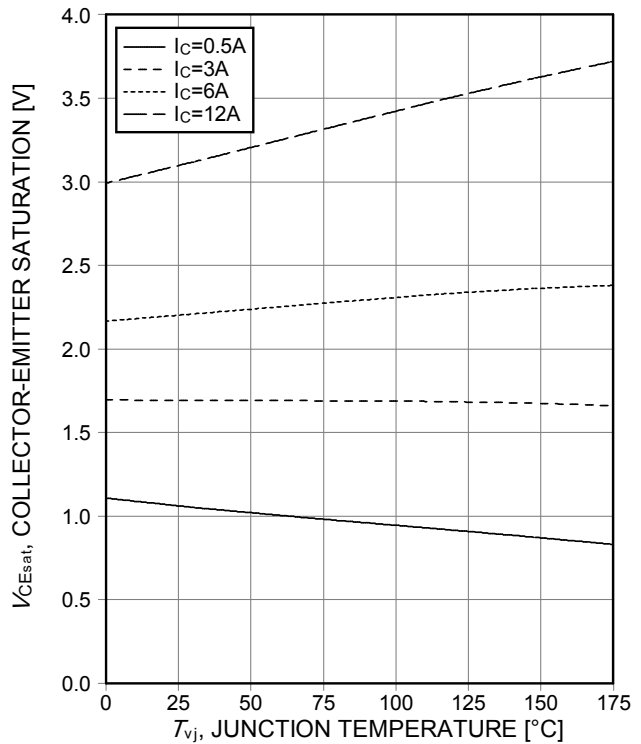

Figure 8. Typical collector-emitter saturation voltage as a function of junction temperature ($V_{ge}=15\text{V}$)

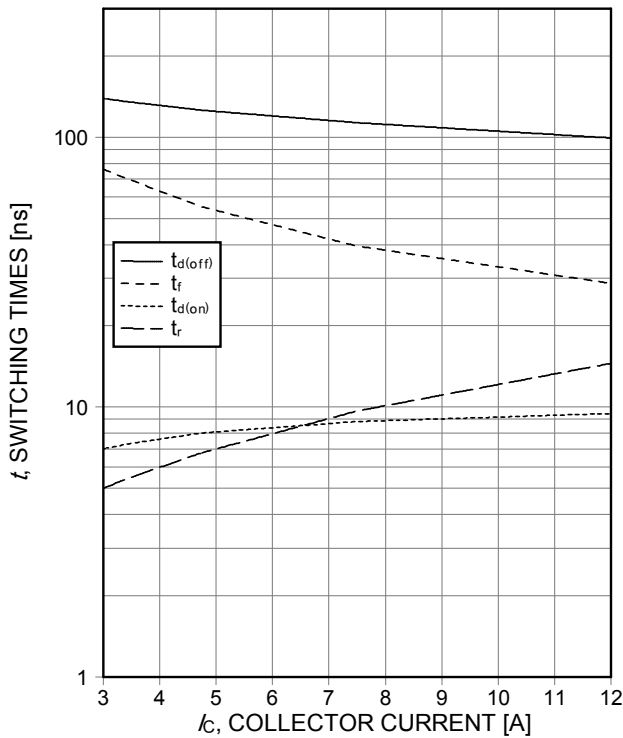

Figure 9. Typical switching times as a function of collector current
(inductive load, $T_{vj}=175^{\circ}\text{C}$, $V_{CE}=400\text{V}$, $V_{GE}=15/0\text{V}$, $r_G=23\Omega$, Dynamic test circuit in Figure E)

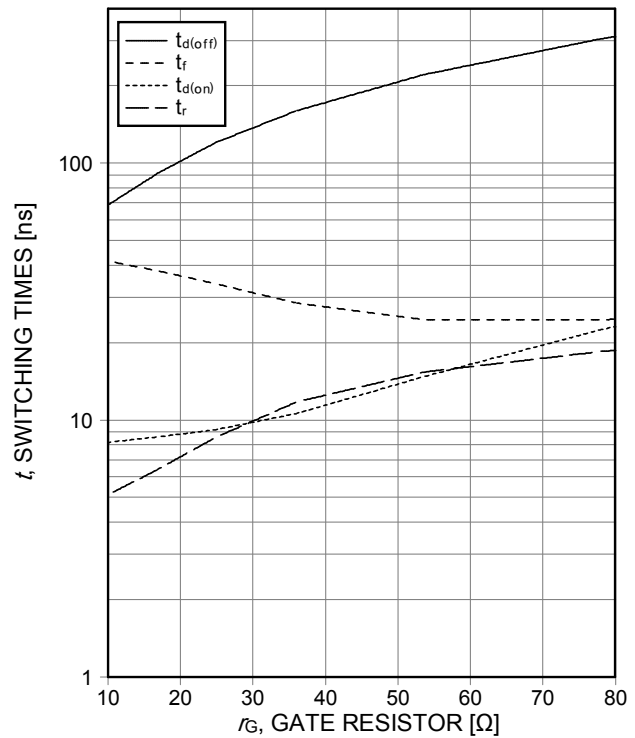

Figure 10. Typical switching times as a function of gate resistor
(inductive load, $T_{vj}=175^{\circ}\text{C}$, $V_{CE}=400\text{V}$, $V_{GE}=15/0\text{V}$, $I_C=6\text{A}$, Dynamic test circuit in Figure E)

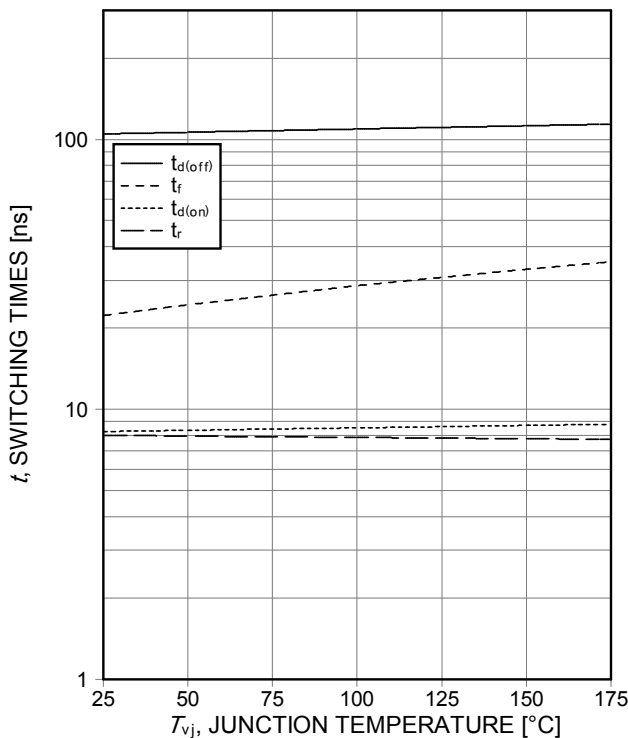

Figure 11. Typical switching times as a function of junction temperature
(inductive load, $V_{CE}=400\text{V}$, $V_{GE}=15/0\text{V}$, $I_C=6\text{A}$, $r_G=23\Omega$, Dynamic test circuit in Figure E)

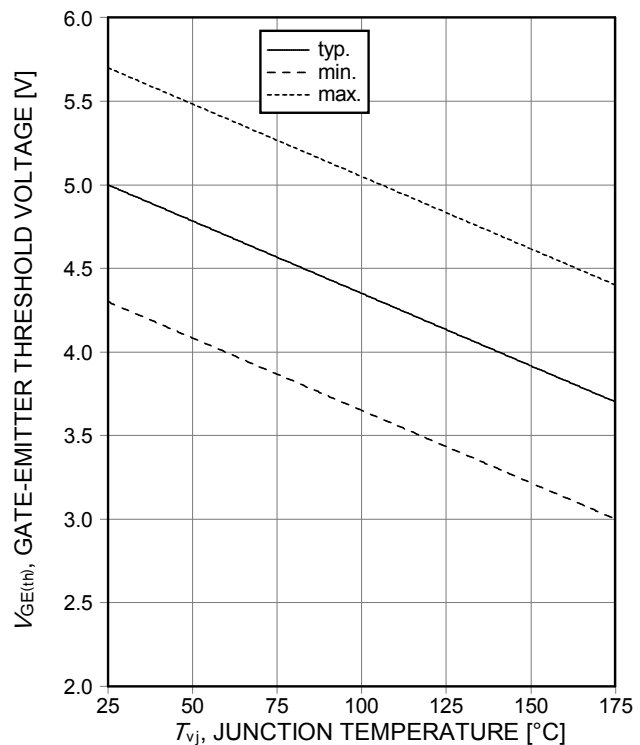

Figure 12. Gate-emitter threshold voltage as a function of junction temperature
($I_C=0,11\text{mA}$)

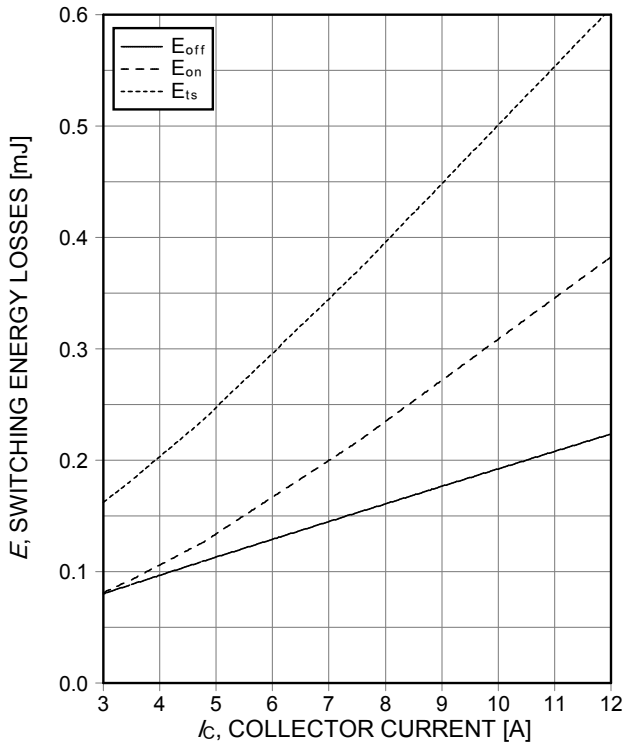

Figure 13. Typical switching energy losses as a function of collector current
 (inductive load, $T_{vj}=175^\circ\text{C}$, $V_{CE}=400\text{V}$, $V_{GE}=15/0\text{V}$, $r_G=23\Omega$, Dynamic test circuit in Figure E)

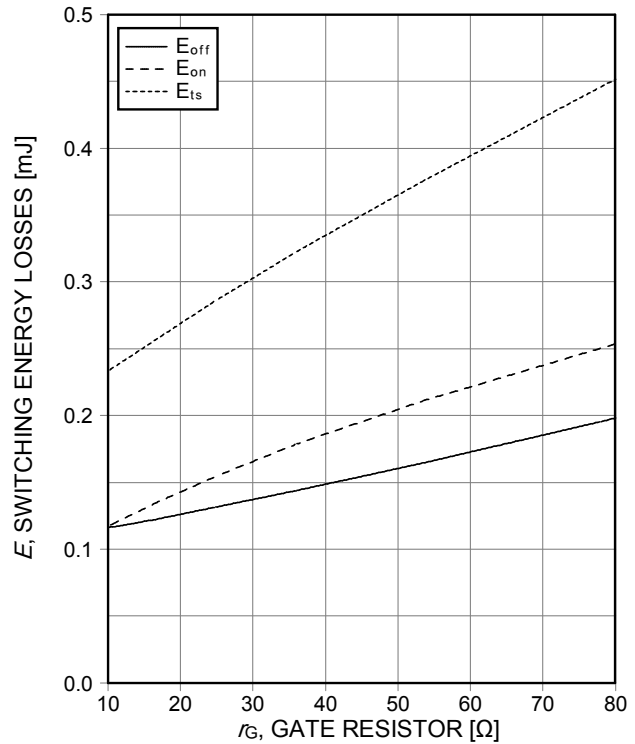

Figure 14. Typical switching energy losses as a function of gate resistor
 (inductive load, $T_{vj}=175^\circ\text{C}$, $V_{CE}=400\text{V}$, $V_{GE}=15/0\text{V}$, $I_C=6\text{A}$, Dynamic test circuit in Figure E)

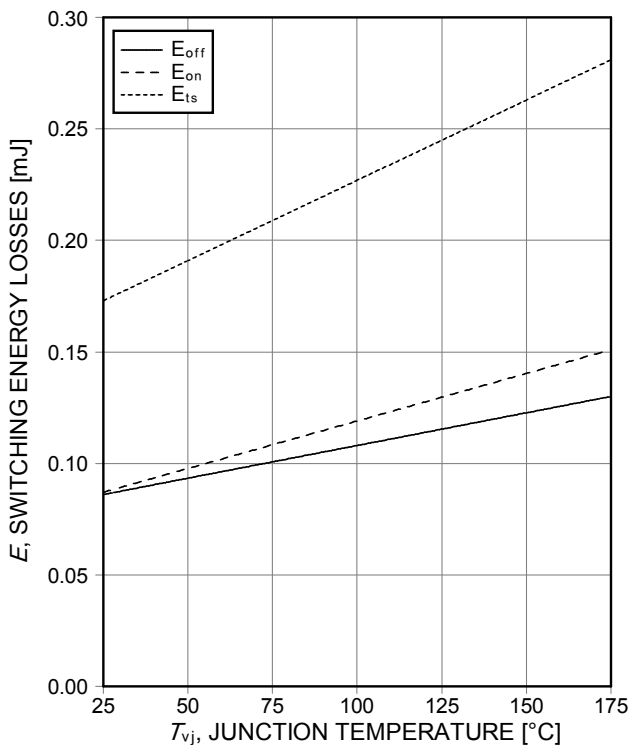

Figure 15. Typical switching energy losses as a function of junction temperature
 (inductive load, $V_{CE}=400\text{V}$, $V_{GE}=15/0\text{V}$, $I_C=6\text{A}$, $r_G=23\Omega$, Dynamic test circuit in Figure E)

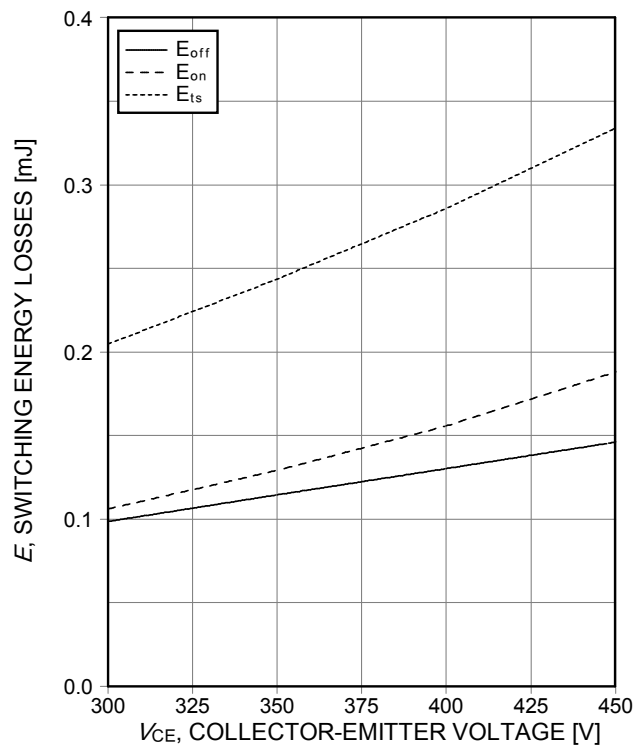

Figure 16. Typical switching energy losses as a function of collector emitter voltage
 (inductive load, $T_{vj}=175^\circ\text{C}$, $V_{GE}=15/0\text{V}$, $I_C=6\text{A}$, $r_G=23\Omega$, Dynamic test circuit in Figure E)

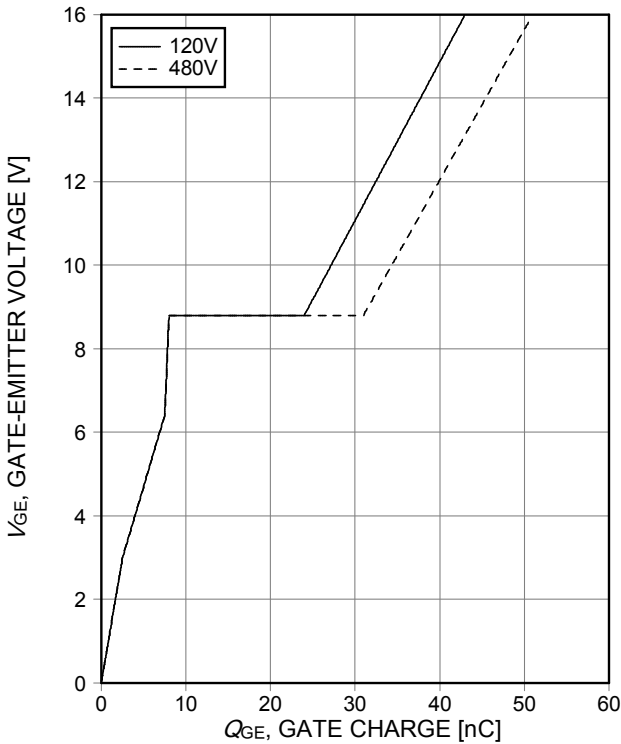

Figure 17. Typical gate charge
($I_C=6A$)

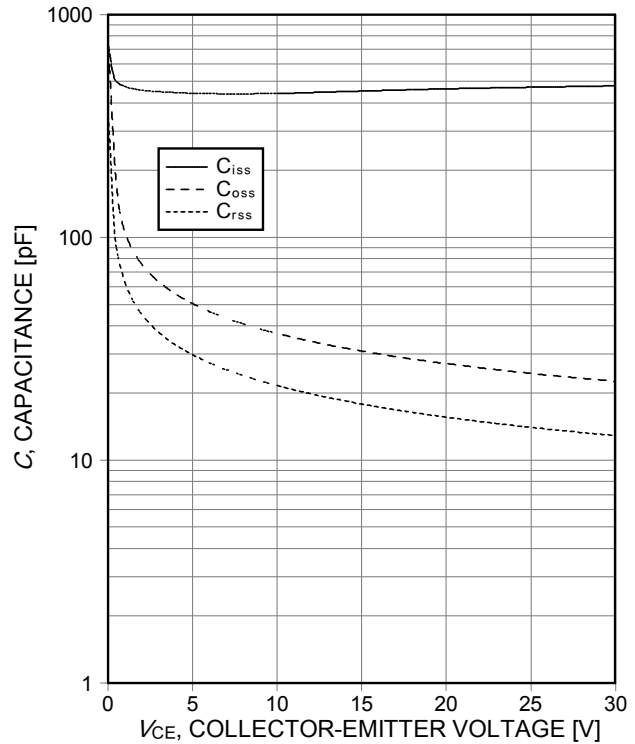

Figure 18. Typical capacitance as a function of collector-emitter voltage
($V_{GE}=0V, f=1MHz$)

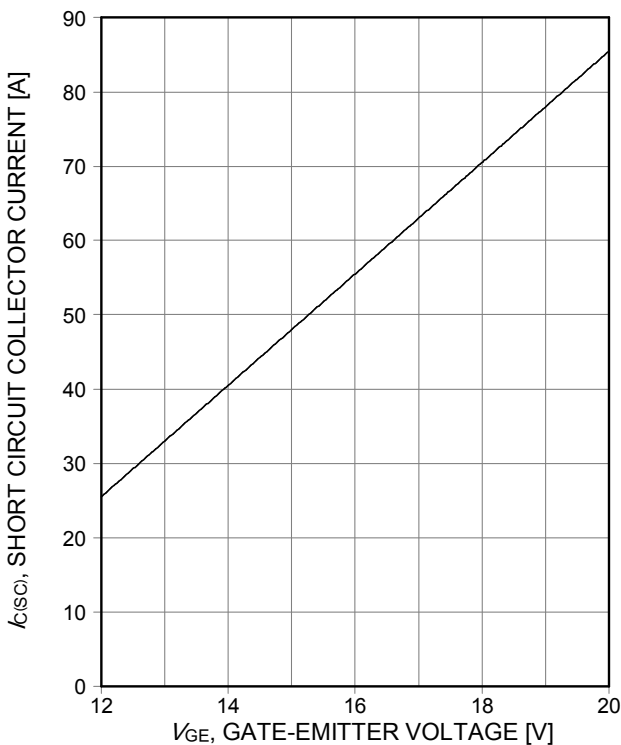

Figure 19. Typical short circuit collector current as a function of gate-emitter voltage
($V_{CE}\leq 400V, \text{start at } T_{vj}=25^\circ C$)

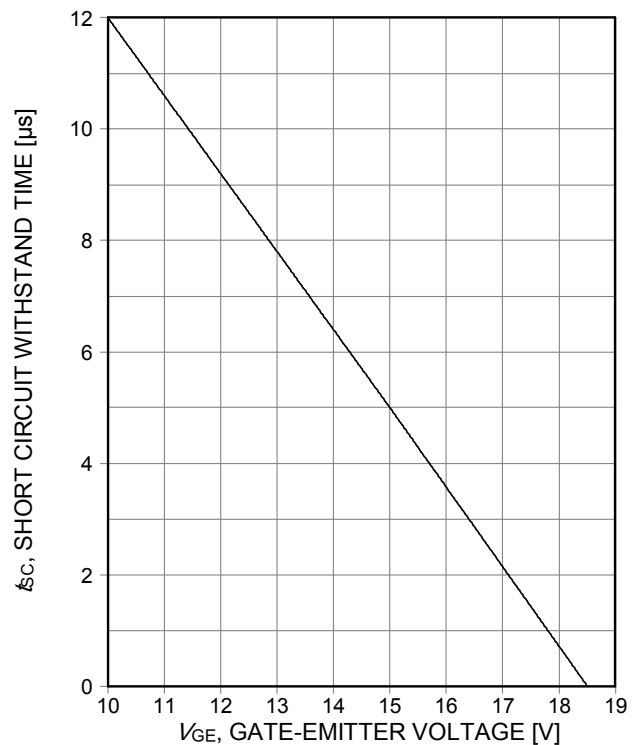

Figure 20. Short circuit withstand time as a function of gate-emitter voltage
($V_{CE}\leq 400V, \text{start at } T_{vj}=150^\circ C$)

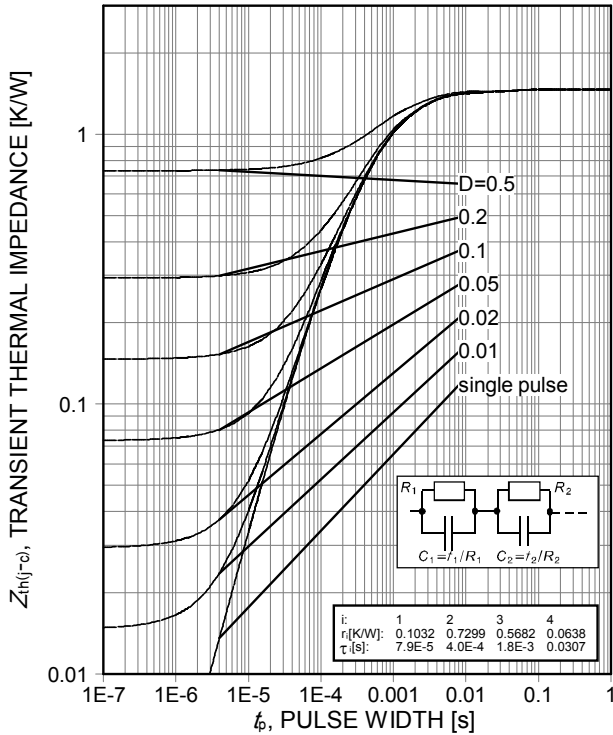

Figure 21. IGBT transient thermal impedance as a function of pulse width ¹⁾ (see page 4) ($D = \phi_p/T$)

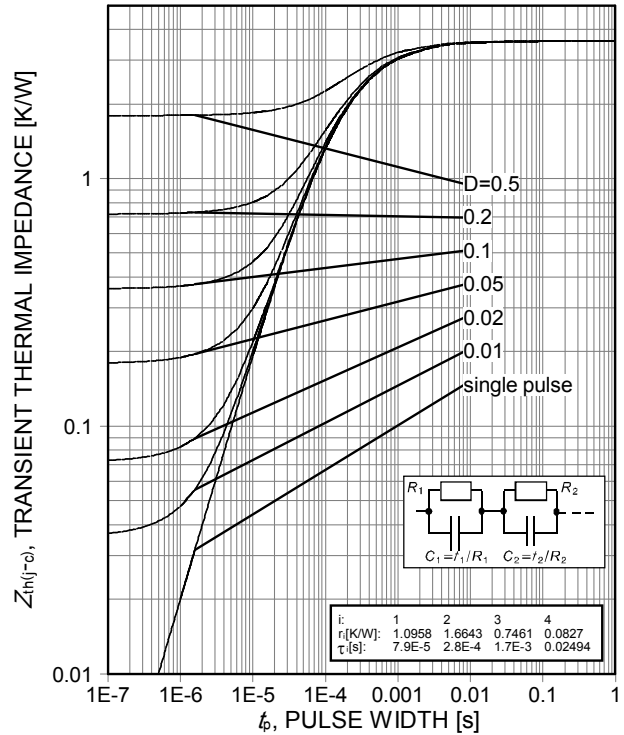

Figure 22. Diode transient thermal impedance as a function of pulse width ²⁾ (see page 4) ($D = \phi_p/T$)

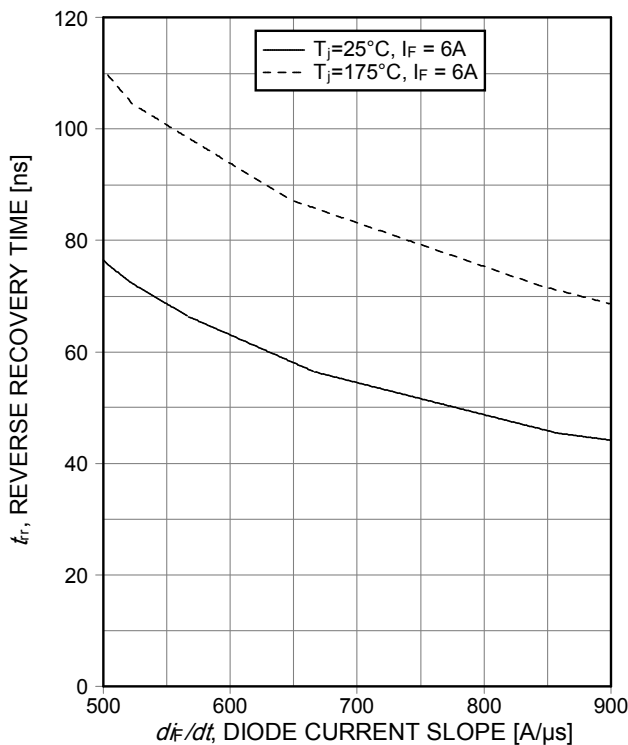

Figure 23. Typical reverse recovery time as a function of diode current slope ($V_R = 400V$)

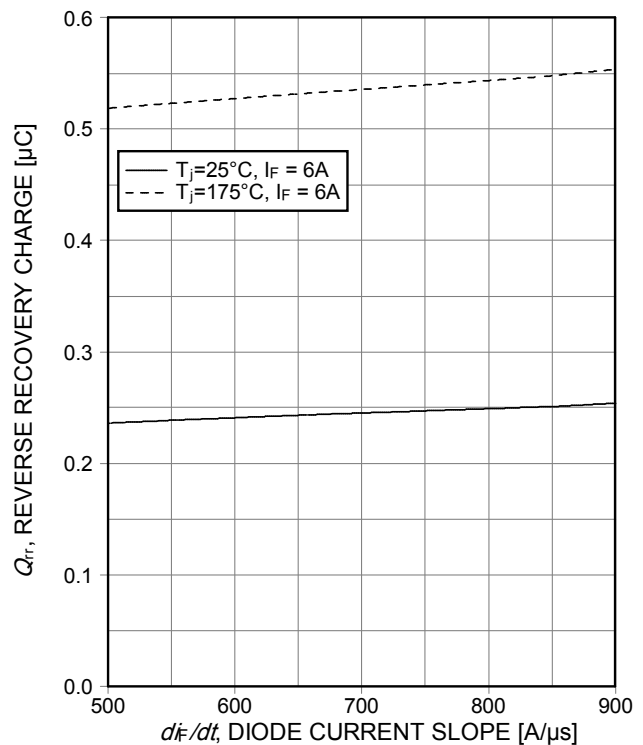

Figure 24. Typical reverse recovery charge as a function of diode current slope ($V_R = 400V$)

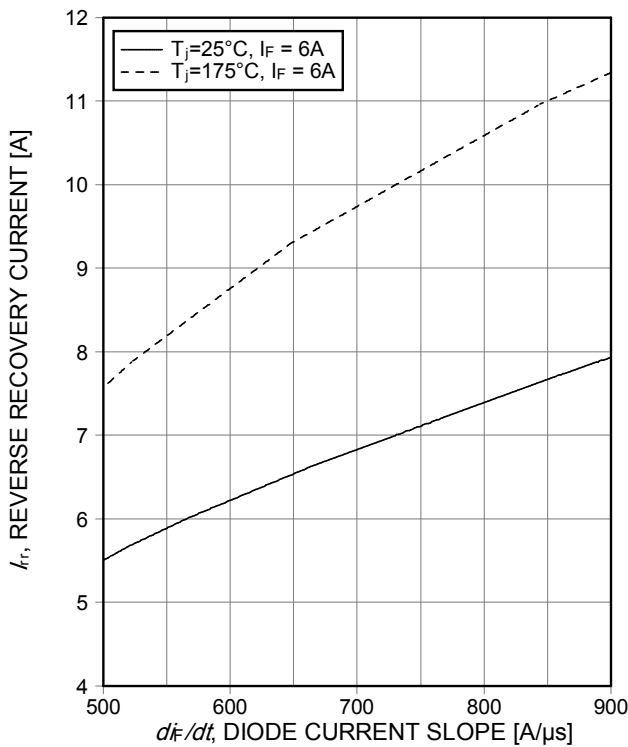

Figure 25. Typical reverse recovery current as a function of diode current slope ($V_R=400V$)

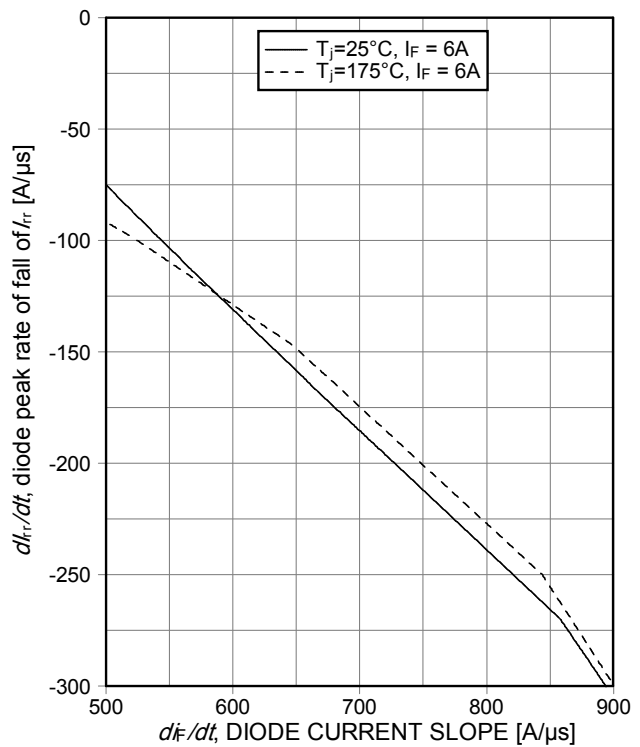

Figure 26. Typical diode peak rate of fall of reverse recovery current as a function of diode current slope ($V_R=400V$)

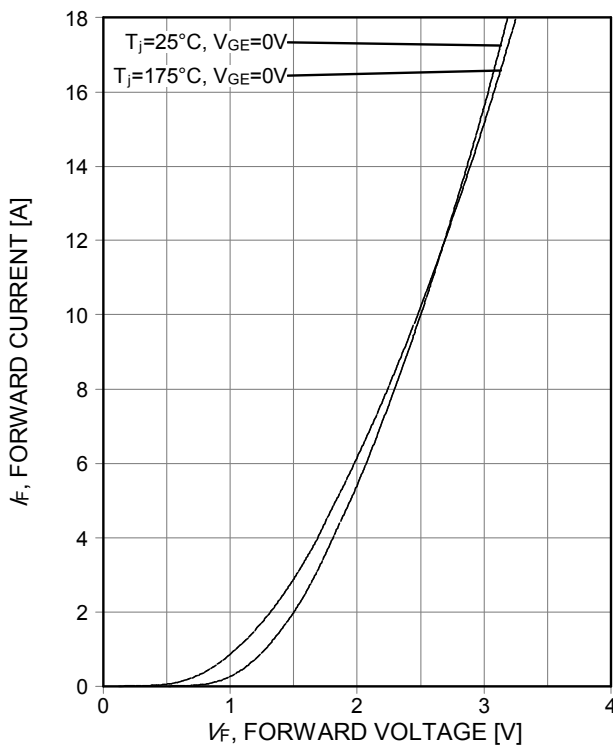

Figure 27. Typical diode forward current as a function of forward voltage

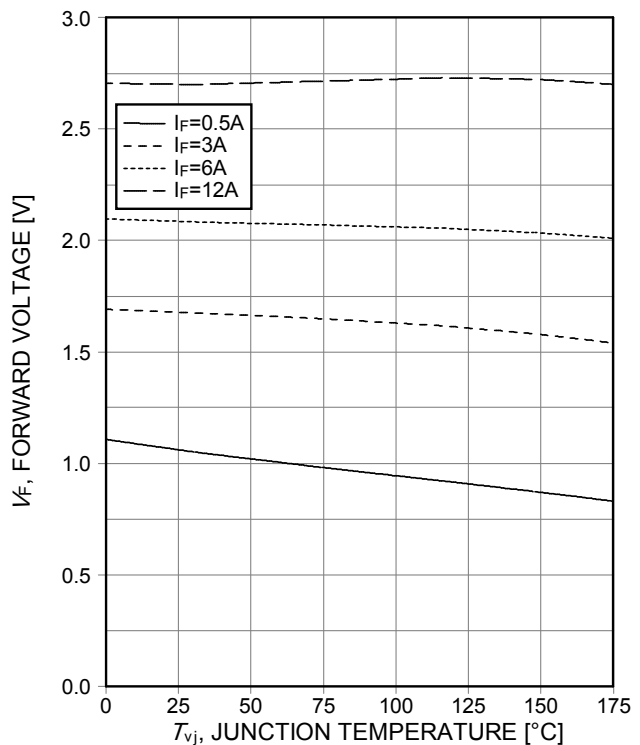
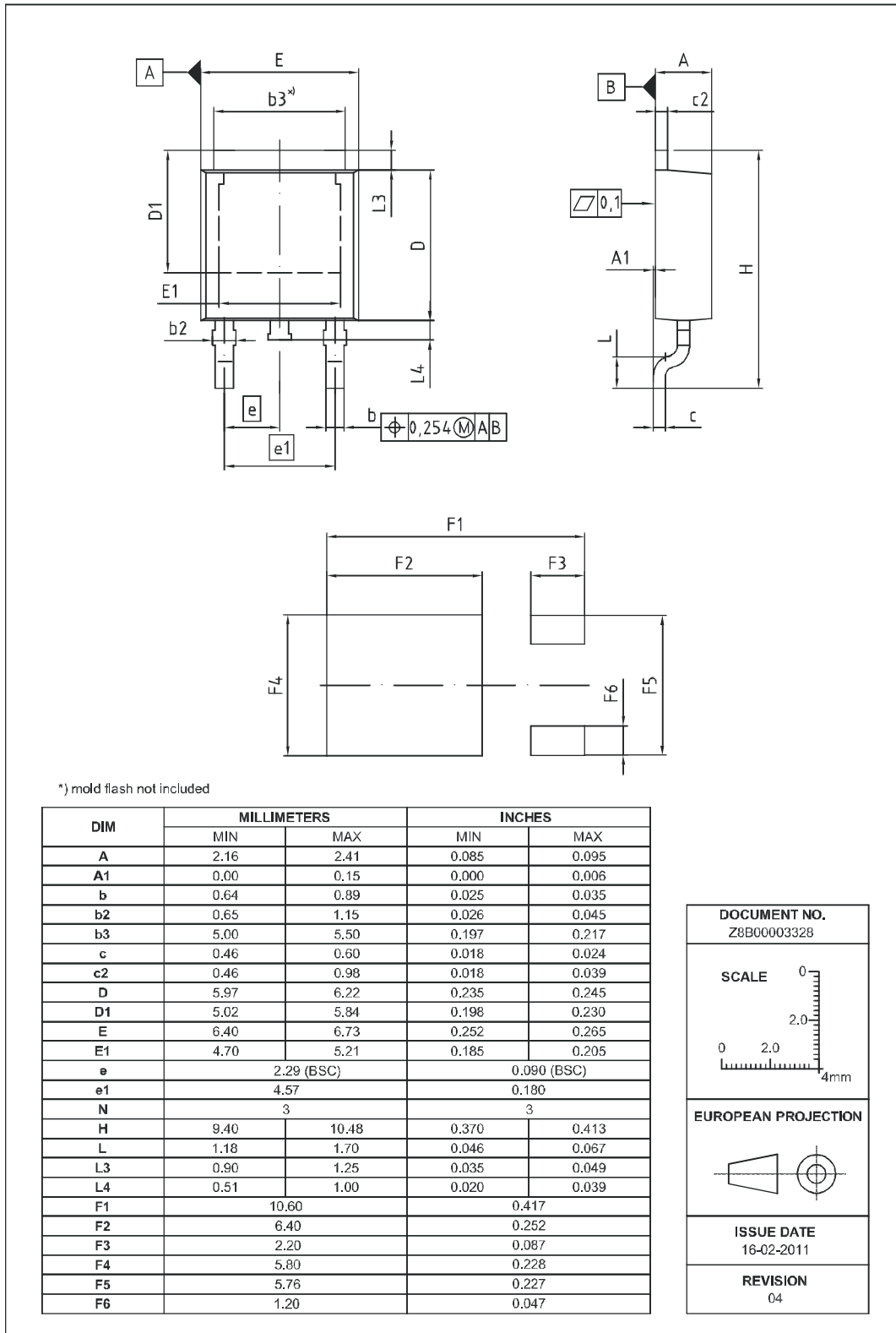

Figure 28. Typical diode forward voltage as a function of junction temperature

PG-TO252 -3



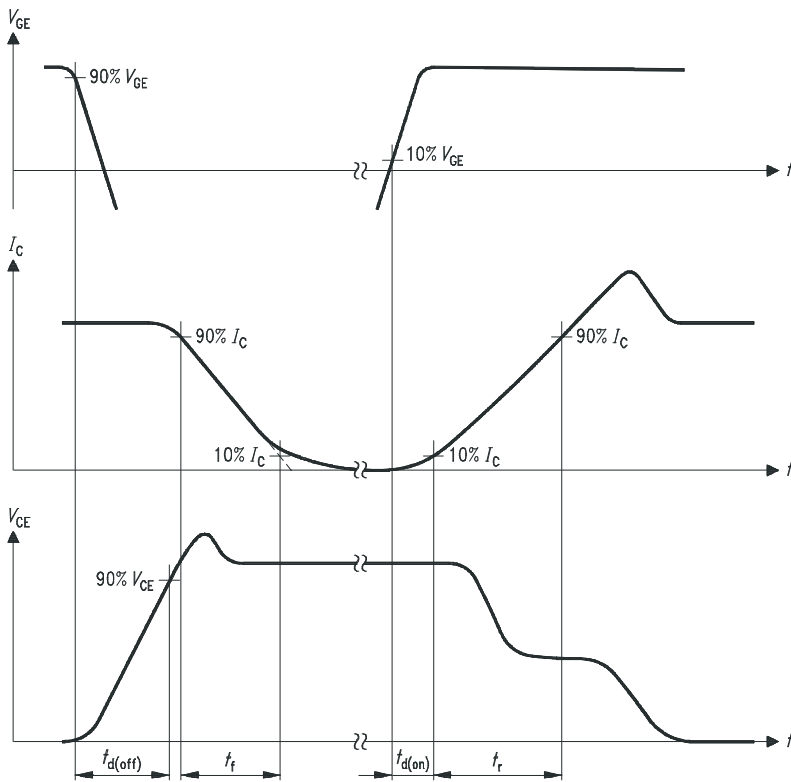

Figure A. Definition of switching times



Figure B. Definition of switching losses

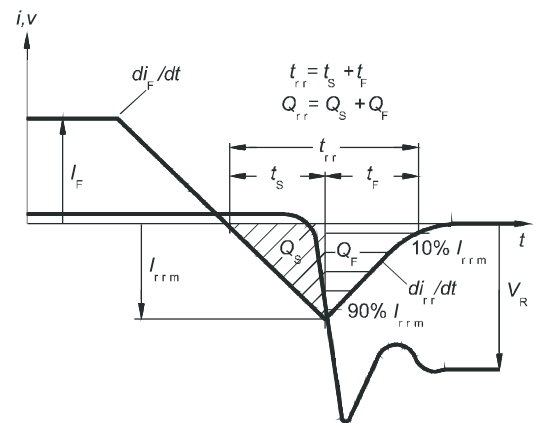

Figure C. Definition of diodes switching characteristics

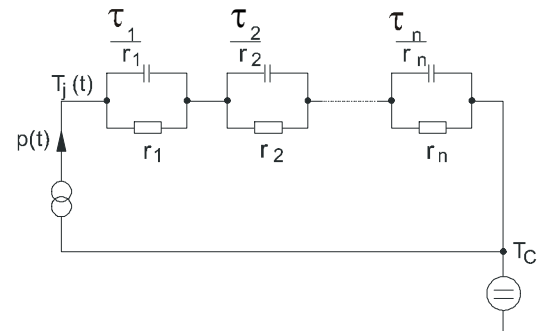

Figure D. Thermal equivalent circuit

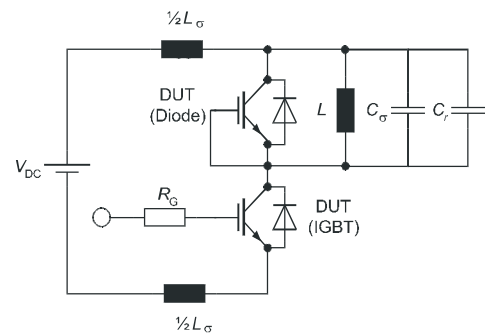

Figure E. Dynamic test circuit
Parasitic inductance L_{σ} ,
Parasitic capacitor C_{σ} ,
Relief capacitor C_r
(only for ZVT switching)

Revision History

IKD06N60RF

Revision: 2012-02-24, Rev. 2.1

Previous Revision

Revision	Date	Subjects (major changes since last revision)
2.1	2012-02-24	Final data sheet

We Listen to Your Comments

Any information within this document that you feel is wrong, unclear or missing at all ?

Your feedback will help us to continuously improve the quality of this document.

Please send your proposal (including a reference to this document) to: erratum@infineon.com

Published by**Infineon Technologies AG****81726 Munich, Germany****81726 München, Germany****© 2012 Infineon Technologies AG****All Rights Reserved.****Legal Disclaimer**

The information given in this document shall in no event be regarded as a guarantee of conditions or characteristics. With respect to any examples or hints given herein, any typical values stated herein and/or any information regarding the application of the device, Infineon Technologies hereby disclaims any and all warranties and liabilities of any kind, including without limitation, warranties of non-infringement of intellectual property rights of any third party.

Information

For further information on technology, delivery terms and conditions and prices, please contact the nearest Infineon Technologies Office (www.infineon.com).

Warnings

Due to technical requirements, components may contain dangerous substances. For information on the types in question, please contact the nearest Infineon Technologies Office.

The Infineon Technologies component described in this Data Sheet may be used in life-support devices or systems and/or automotive, aviation and aerospace applications or systems only with the express written approval of Infineon Technologies, if a failure of such components can reasonably be expected to cause the failure of that life-support, automotive, aviation and aerospace device or system or to affect the safety or effectiveness of that device or system. Life support devices or systems are intended to be implanted in the human body or to support and/or maintain and sustain and/or protect human life. If they fail, it is reasonable to assume that the health of the user or other persons may be endangered.



Стандарт Электрон Связь

Мы молодая и активно развивающаяся компания в области поставок электронных компонентов. Мы поставляем электронные компоненты отечественного и импортного производства напрямую от производителей и с крупнейших складов мира.

Благодаря сотрудничеству с мировыми поставщиками мы осуществляем комплексные и плановые поставки широчайшего спектра электронных компонентов.

Собственная эффективная логистика и склад в обеспечивает надежную поставку продукции в точно указанные сроки по всей России.

Мы осуществляем техническую поддержку нашим клиентам и предпродажную проверку качества продукции. На все поставляемые продукты мы предоставляем гарантию .

Осуществляем поставки продукции под контролем ВП МО РФ на предприятия военно-промышленного комплекса России , а также работаем в рамках 275 ФЗ с открытием отдельных счетов в уполномоченном банке. Система менеджмента качества компании соответствует требованиям ГОСТ ISO 9001.

Минимальные сроки поставки, гибкие цены, неограниченный ассортимент и индивидуальный подход к клиентам являются основой для выстраивания долгосрочного и эффективного сотрудничества с предприятиями радиоэлектронной промышленности, предприятиями ВПК и научно-исследовательскими институтами России.

С нами вы становитесь еще успешнее!

Наши контакты:

Телефон: +7 812 627 14 35

Электронная почта: sales@st-electron.ru

Адрес: 198099, Санкт-Петербург,
Промышленная ул, дом № 19, литера Н,
помещение 100-Н Офис 331