

N-channel 60 V, 0.019 Ω typ., 8 A STripFET™ F7 Power MOSFET in a PowerFLAT™ 3.3x3.3 package

Datasheet - production data

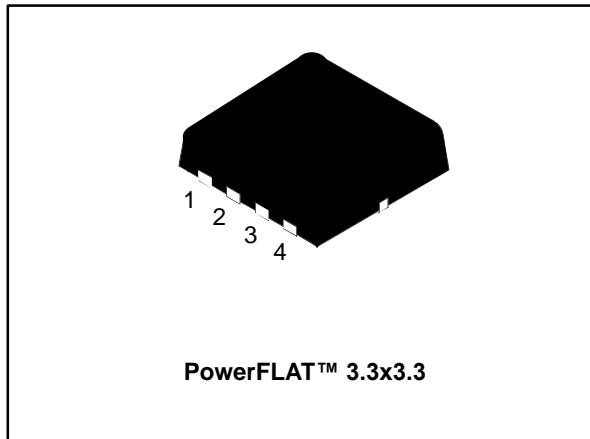

Figure 1: Internal schematic diagram

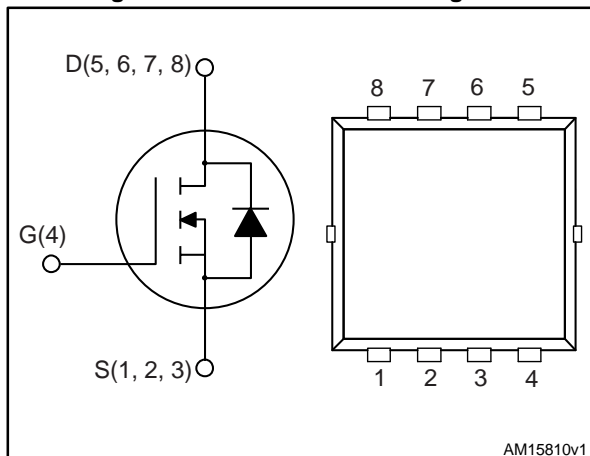

Table 1: Device summary

Order code	Marking	Package	Packing
STL8N6F7	8N6F7	PowerFLAT™ 3.3x3.3	Tape and reel

Features

Order code	V _{DS}	R _{DS(on)} max	I _D
STL8N6F7	60 V	0.023 Ω	8 A

- Among the lowest R_{DS(on)} on the market
- Excellent figure of merit (FoM)
- Low C_{rss}/C_{iss} ratio for EMI immunity
- High avalanche ruggedness

Applications

- Switching applications

Description

This N-channel Power MOSFET utilizes STripFET™ F7 technology with an enhanced trench gate structure that results in very low on-state resistance, while also reducing internal capacitance and gate charge for faster and more efficient switching.

Contents

1	Electrical ratings	3
2	Electrical characteristics	4
	2.1 Electrical characteristics (curves).....	5
3	Test circuits	7
4	Package information	8
	4.1 PowerFLAT 3.3x3.3 package information	9
5	Revision history	12

1 Electrical ratings

Table 2: Absolute maximum ratings

Symbol	Parameter	Value	Unit
V_{DS}	Drain-source voltage	60	V
V_{GS}	Gate-source voltage	± 20	V
$I_D^{(1)}$	Drain current (continuous) at $T_C = 25\text{ }^\circ\text{C}$	36	A
$I_D^{(1)}$	Drain current (continuous) at $T_C = 100\text{ }^\circ\text{C}$	22	A
$I_{DM}^{(1)(2)}$	Drain current (pulsed)	144	A
$I_D^{(3)}$	Drain current (continuous) at $T_{pcb} = 25\text{ }^\circ\text{C}$	8	A
$I_D^{(3)}$	Drain current (continuous) at $T_{pcb} = 100\text{ }^\circ\text{C}$	5	A
$I_{DM}^{(2)(3)}$	Drain current (pulsed)	32	A
$P_{TOT}^{(1)}$	Total dissipation at $T_C = 25\text{ }^\circ\text{C}$	60	W
$P_{TOT}^{(3)}$	Total dissipation at $T_{pcb} = 25\text{ }^\circ\text{C}$	3	W
T_{stg}	Storage temperature	-55 to 150	$^\circ\text{C}$
T_j	Operating junction temperature		

Notes:

- (1) This value is rated according to R_{thj-c} .
- (2) Pulse width limited by safe operating area.
- (3) This value is rated according to $R_{thj-pcb}$.

Table 3: Thermal data

Symbol	Parameter	Value	Unit
$R_{thj-pcb}^{(1)}$	Thermal resistance junction-pcb max.	42.8	$^\circ\text{C/W}$
$R_{thj-case}$	Thermal resistance junction-case max.	2.1	$^\circ\text{C/W}$

Notes:

- (1) When mounted on FR-4 board of 1 inch², 2oz Cu, $t < 10$ sec.

2 Electrical characteristics

(T_C = 25 °C unless otherwise specified)

Table 4: On /off states

Symbol	Parameter	Test conditions	Min.	Typ.	Max.	Unit
V _{(BR)DSS}	Drain-source breakdown voltage	I _D = 1 mA, V _{GS} = 0 V	60			V
I _{DSS}	Zero gate voltage drain current	V _{GS} = 0 V V _{DS} = 60 V			1	μA
I _{GSS}	Gate-body leakage current	V _{GS} = 20 V, V _{DS} = 0 V			100	nA
V _{GS(th)}	Gate threshold voltage	V _{DS} = V _{GS} , I _D = 250 μA	2		4	V
R _{DS(on)}	Static drain-source on-resistance	V _{GS} = 10 V, I _D = 4 A		0.019	0.023	Ω

Table 5: Dynamic

Symbol	Parameter	Test conditions	Min.	Typ.	Max.	Unit
C _{iss}	Input capacitance	V _{DS} = 30 V, f = 1 MHz, V _{GS} = 0 V	-	420	-	pF
C _{oss}	Output capacitance		-	215	-	pF
C _{rss}	Reverse transfer capacitance		-	16	-	pF
Q _g	Total gate charge	V _{DD} = 30 V, I _D = 8 A, V _{GS} = 10 V (see Figure 14 : "Test circuit for gate charge behavior")	-	8	-	nC
Q _{gs}	Gate-source charge		-	2.3	-	nC
Q _{gd}	Gate-drain charge		-	2.1	-	nC

Table 6: Switching times

Symbol	Parameter	Test conditions	Min.	Typ.	Max.	Unit
t _{d(on)}	Turn-on delay time	V _{DD} = 30 V, I _D = 4 A, R _G = 4.7 Ω, V _{GS} = 10 V (see Figure 13 : "Test circuit for resistive load switching times")	-	7.85	-	ns
t _r	Rise time		-	3.25	-	ns
t _{d(off)}	Turn-off delay time		-	12.1	-	ns
t _f	Fall time		-	3.95	-	ns

Table 7: Source-drain diode

Symbol	Parameter	Test conditions	Min.	Typ.	Max.	Unit
V _{SD} ⁽¹⁾	Forward on voltage	I _{SD} = 8 A, V _{GS} = 0 V	-		1.2	V
t _{rr}	Reverse recovery time	I _D = 8 A, di/dt = 100 A/μs V _{DD} = 48 V (see Figure 15 : "Test circuit for inductive load switching and diode recovery times")	-	17.1		ns
Q _{rr}	Reverse recovery charge		-	6.67		nC
I _{RRM}	Reverse recovery current		-	0.8		A

Notes:

⁽¹⁾Pulsed: pulse duration = 300 μs, duty cycle 1.5%

2.1 Electrical characteristics (curves)

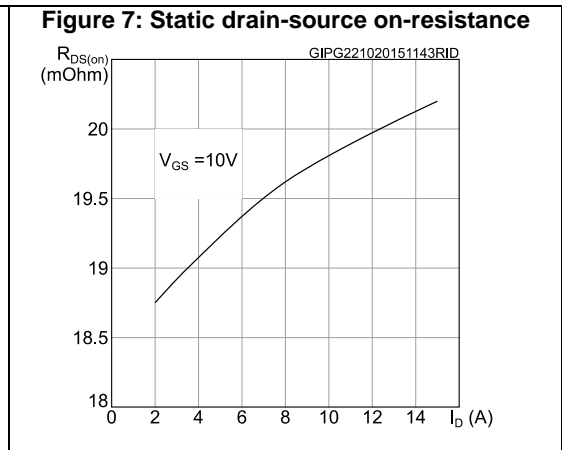
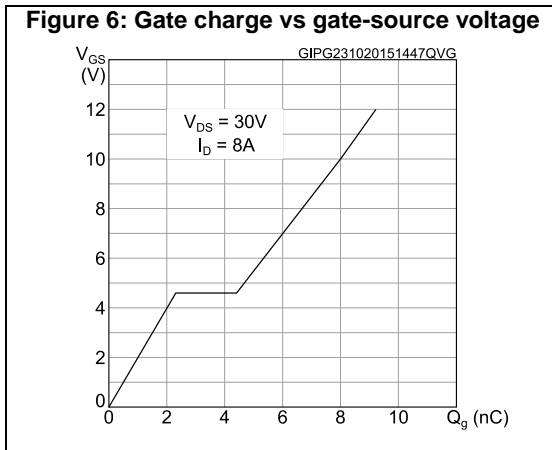
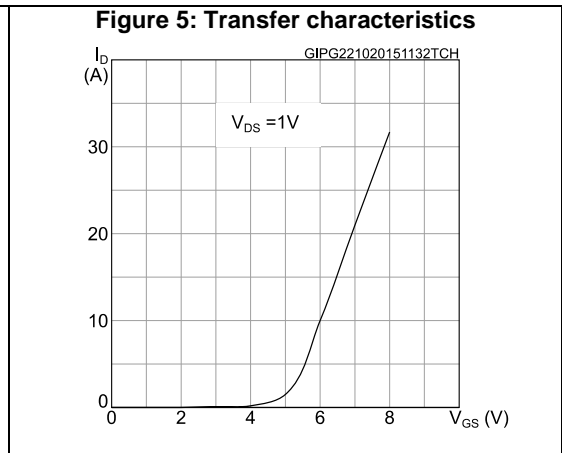
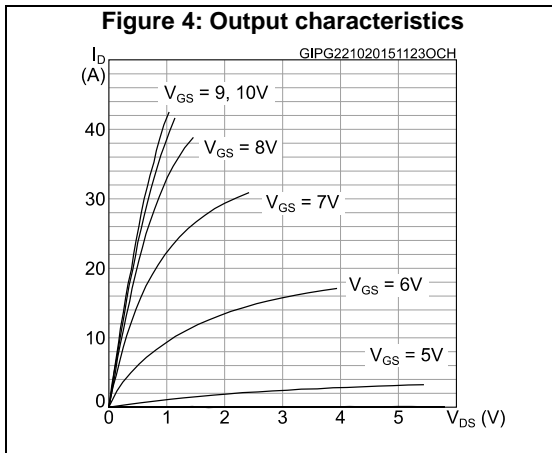
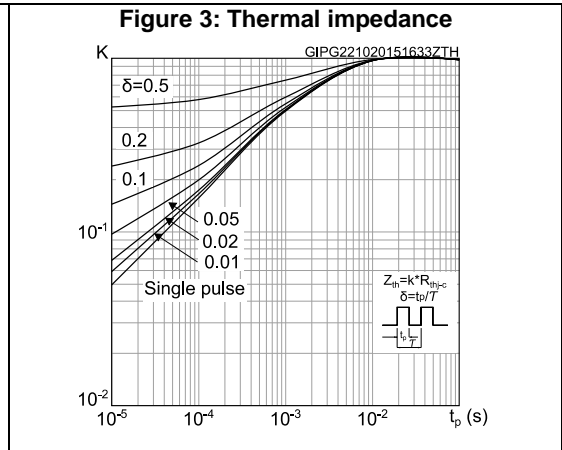
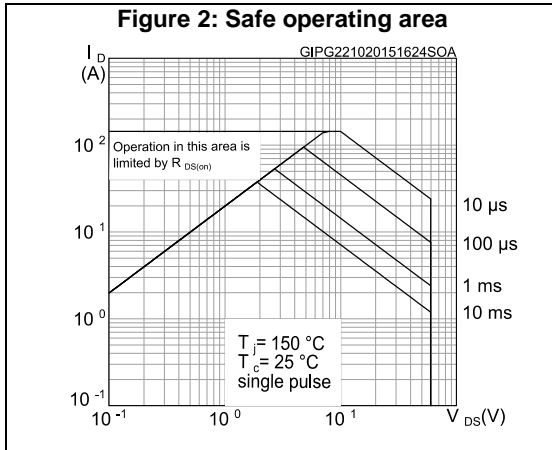

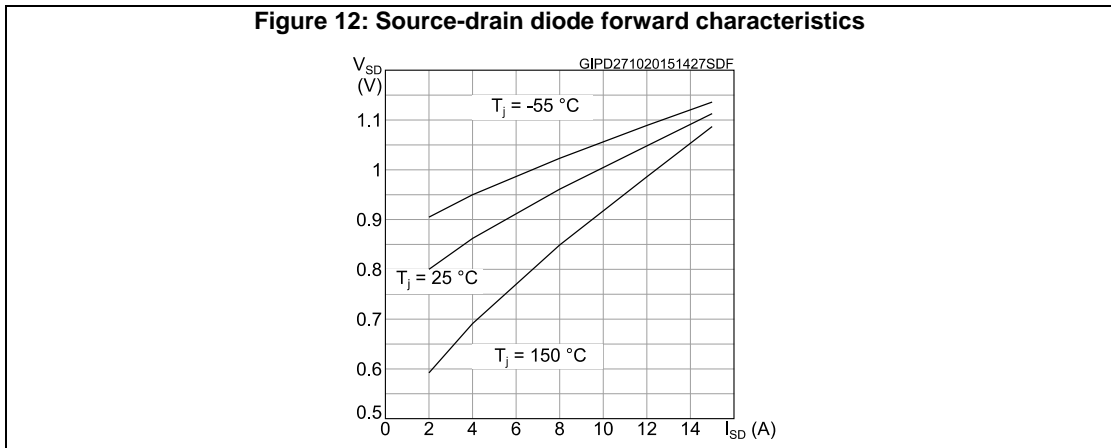
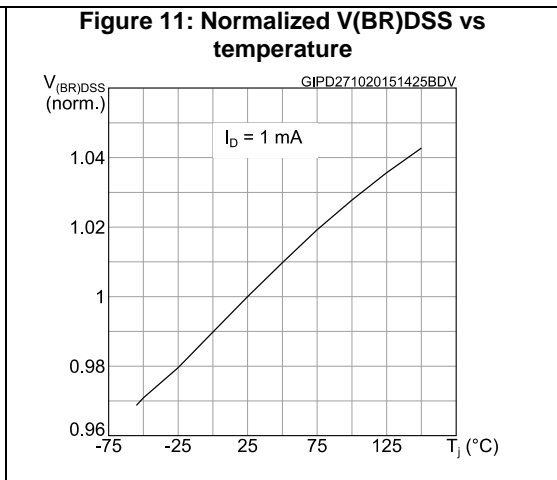
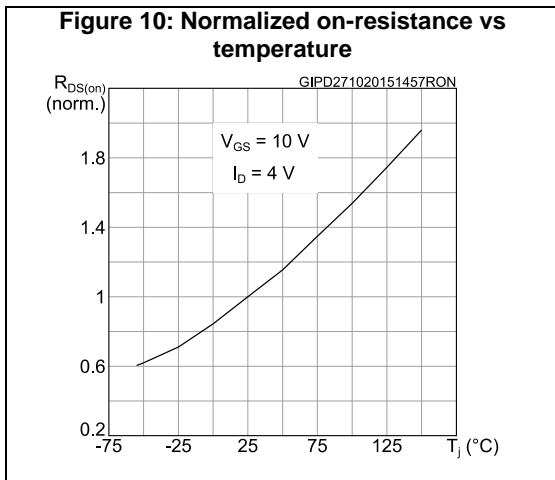
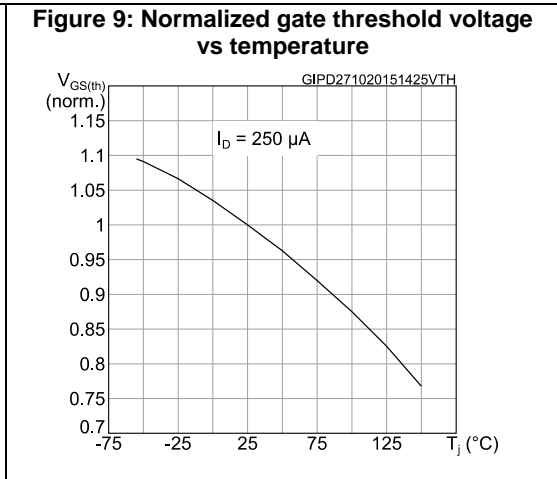
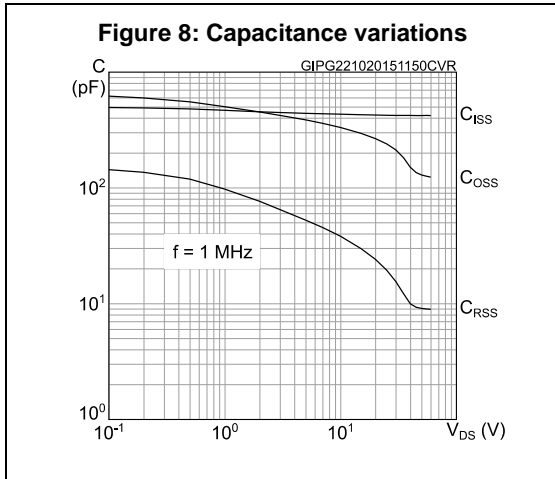

3 Test circuits

Figure 13: Test circuit for resistive load switching times

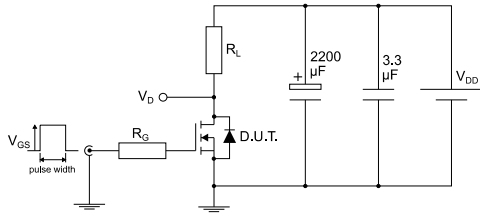

AM01468v1

Figure 14: Test circuit for gate charge behavior

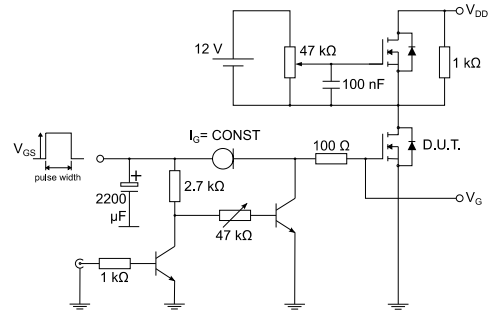

AM01469v1

Figure 15: Test circuit for inductive load switching and diode recovery times

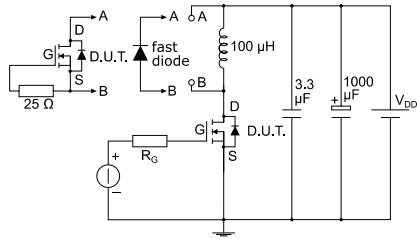

AM01470v1

Figure 16: Unclamped inductive load test circuit

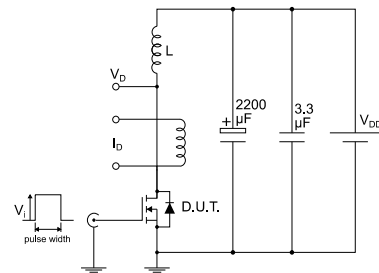

AM01471v1

Figure 17: Unclamped inductive waveform

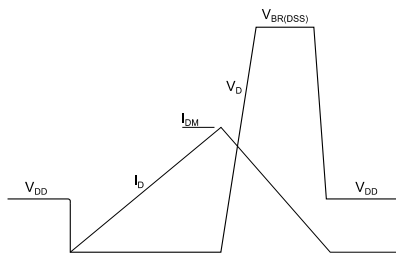

AM01472v1

Figure 18: Switching time waveform

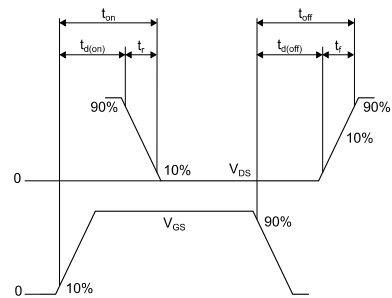

AM01473v1

4 Package information

In order to meet environmental requirements, ST offers these devices in different grades of ECOPACK® packages, depending on their level of environmental compliance. ECOPACK® specifications, grade definitions and product status are available at: www.st.com. ECOPACK® is an ST trademark.

4.1 PowerFLAT 3.3x3.3 package information

Figure 19: PowerFLAT™ 3.3x3.3 package outline

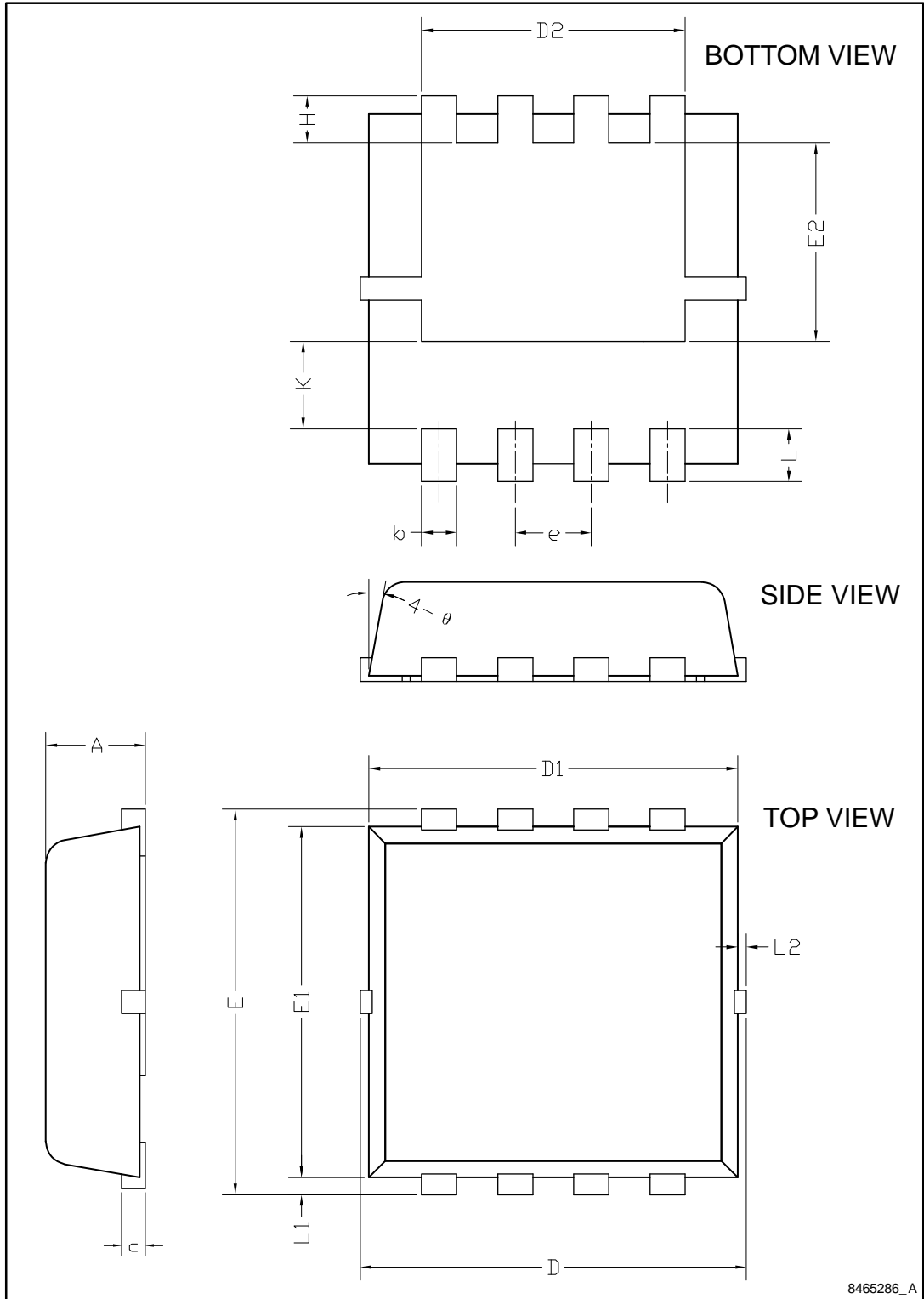
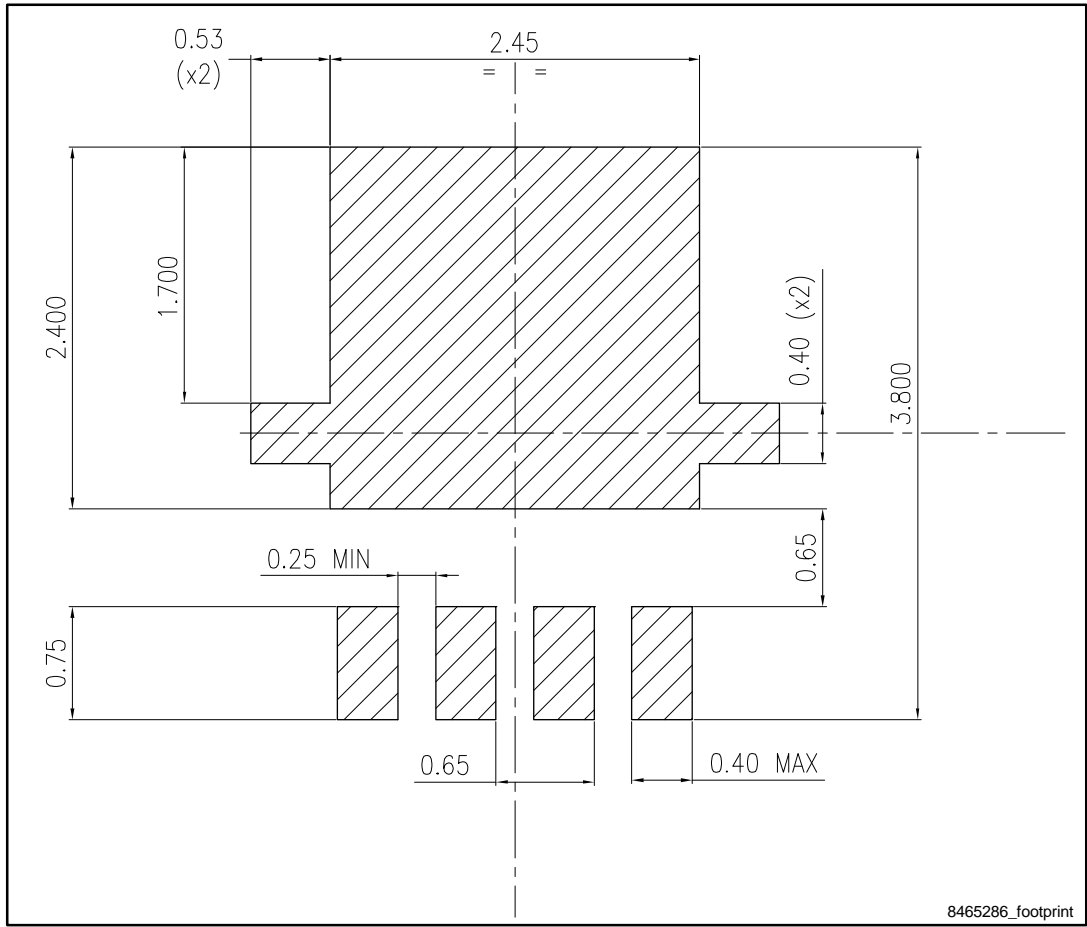

Table 8: PowerFLAT™ 3.3x3.3 package mechanical data

Dim.	mm		
	Min.	Typ.	Max.
A	0.70	0.80	0.90
b	0.25	0.30	0.39
c	0.14	0.15	0.20
D	3.10	3.30	3.50
D1	3.05	3.15	3.25
D2	2.15	2.25	2.35
e	0.55	0.65	0.75
E	3.10	3.30	3.50
E1	2.90	3.00	3.10
E2	1.60	1.70	1.80
H	0.25	0.40	0.55
K	0.65	0.75	0.85
L	0.30	0.45	0.60
L1	0.05	0.15	0.25
L2			0.15
θ	8°	10°	12°

Figure 20: PowerFLAT™ 3.3x3.3 recommended footprint



5 Revision history

Table 9: Document revision history

Date	Revision	Changes
20-Aug-2015	1	First release.
22-Oct-2015	2	Updated title and features in cover page. Updated Table 4: "On /off states" , Table 5: "Dynamic" , Table 6: "Switching times" and Table 7: "Source-drain diode" . Added Section 3.1: "Electrical characteristics (curves)" . Document status promoted from preliminary di production data.

IMPORTANT NOTICE – PLEASE READ CAREFULLY

STMicroelectronics NV and its subsidiaries ("ST") reserve the right to make changes, corrections, enhancements, modifications, and improvements to ST products and/or to this document at any time without notice. Purchasers should obtain the latest relevant information on ST products before placing orders. ST products are sold pursuant to ST's terms and conditions of sale in place at the time of order acknowledgement.

Purchasers are solely responsible for the choice, selection, and use of ST products and ST assumes no liability for application assistance or the design of Purchasers' products.

No license, express or implied, to any intellectual property right is granted by ST herein.

Resale of ST products with provisions different from the information set forth herein shall void any warranty granted by ST for such product.

ST and the ST logo are trademarks of ST. All other product or service names are the property of their respective owners.

Information in this document supersedes and replaces information previously supplied in any prior versions of this document.

© 2015 STMicroelectronics – All rights reserved



Стандарт Электрон Связь

Мы молодая и активно развивающаяся компания в области поставок электронных компонентов. Мы поставляем электронные компоненты отечественного и импортного производства напрямую от производителей и с крупнейших складов мира.

Благодаря сотрудничеству с мировыми поставщиками мы осуществляем комплексные и плановые поставки широчайшего спектра электронных компонентов.

Собственная эффективная логистика и склад в обеспечивает надежную поставку продукции в точно указанные сроки по всей России.

Мы осуществляем техническую поддержку нашим клиентам и предпродажную проверку качества продукции. На все поставляемые продукты мы предоставляем гарантию .

Осуществляем поставки продукции под контролем ВП МО РФ на предприятия военно-промышленного комплекса России , а также работаем в рамках 275 ФЗ с открытием отдельных счетов в уполномоченном банке. Система менеджмента качества компании соответствует требованиям ГОСТ ISO 9001.

Минимальные сроки поставки, гибкие цены, неограниченный ассортимент и индивидуальный подход к клиентам являются основой для выстраивания долгосрочного и эффективного сотрудничества с предприятиями радиоэлектронной промышленности, предприятиями ВПК и научно-исследовательскими институтами России.

С нами вы становитесь еще успешнее!

Наши контакты:

Телефон: +7 812 627 14 35

Электронная почта: sales@st-electron.ru

Адрес: 198099, Санкт-Петербург,
Промышленная ул, дом № 19, литера Н,
помещение 100-Н Офис 331