

## FEATURES

Charge pump with automatic gain selection of 1×, 1.5×, and 2× for maximum efficiency

7 independent, programmable LED drivers

7 drivers capable of 30 mA (typical)

1 driver also capable of 60 mA (typical)

Programmable maximum current limit (128 levels)

Standby mode for <1 μA current consumption

16 programmable fade in and fade out times

0.1 sec to 5.5 sec

Choose from linear, square, or cubic rates

Fading override

I<sup>2</sup>C-compatible interface for all programming

Dedicated reset pin and built-in power-on reset (POR)

Short-circuit, overvoltage, and overtemperature protection

Internal soft start to limit inrush currents

Input-to-output isolation during faults or shutdown

Operation down to  $V_{IN} = 2.5$  V with undervoltage lockout (UVLO) at  $V_{IN} = 2.0$  V

Available in a small 20-ball, 2.15 mm × 2.36 mm × 0.6 mm

WLCSOP or a 20-lead, 4 mm × 4 mm × 0.75 mm LFCSP

## APPLICATIONS

Mobile display backlighting

Mobile phone keypad backlighting

Dual RGB backlighting

LED indication

General backlighting of small format displays

## GENERAL DESCRIPTION

The ADP8861 provides a powerful charge pump driver with independent control of up to seven LEDs. These seven LEDs can be independently driven up to 30 mA (typical). The seventh LED can also be driven to 60 mA (typical). All LEDs are programmable for maximum current and fade in/out times via the I<sup>2</sup>C interface. These LEDs can also be combined into groups to reduce the processor instructions during fade in/out.

## TYPICAL OPERATING CIRCUIT

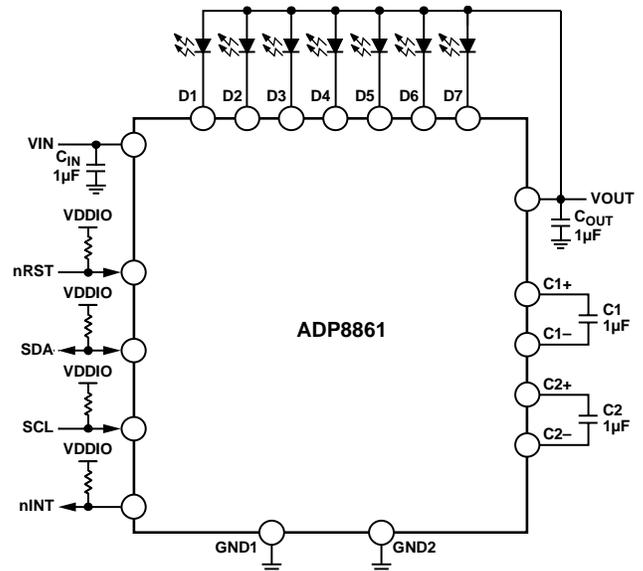

Figure 1.

06391-001

This entire configuration is driven by a two-capacitor charge pump with gains of 1×, 1.5×, and 2×. The charge pump is capable of driving a maximum  $I_{OUT}$  of 240 mA from a supply of 2.5 V to 5.5 V. A full suite of safety features, including short-circuit, overvoltage, and overtemperature protection, allows easy implementation of a safe and robust design. Additionally, input inrush currents are limited via an integrated soft start combined with controlled input-to-output isolation.

## Rev. B

Information furnished by Analog Devices is believed to be accurate and reliable. However, no responsibility is assumed by Analog Devices for its use, nor for any infringements of patents or other rights of third parties that may result from its use. Specifications subject to change without notice. No license is granted by implication or otherwise under any patent or patent rights of Analog Devices. Trademarks and registered trademarks are the property of their respective owners.

## TABLE OF CONTENTS

Features .....	1	Automated Fade In and Fade Out .....	14
Applications .....	1	Backlight Turn On/Turn Off/Dim .....	15
Typical Operating Circuit .....	1	Automatic Dim and Turn Off Timers .....	15
General Description .....	1	Fade Override .....	16
Revision History .....	2	Independent Sink Control .....	16
Specifications .....	3	Short-Circuit Protection Mode .....	16
I <sup>2</sup> C Timing Diagram .....	4	Overvoltage Protection .....	17
Absolute Maximum Ratings .....	5	Thermal Shutdown/Overtemperature Protection .....	17
Maximum Temperature Ranges .....	5	Interrupts .....	17
Thermal Resistance .....	5	Applications Information .....	19
ESD Caution .....	5	Determining the Transition Point of the Charge Pump .....	19
Pin Configurations and Function Descriptions .....	6	Layout Guidelines .....	19
Typical Performance Characteristics .....	7	Example Circuits .....	20
Theory of Operation .....	11	I <sup>2</sup> C Programming and Digital Control .....	21
Power Stage .....	12	Backlight Register Descriptions .....	26
Operating Modes .....	13	Independent Sink Register Descriptions .....	31
Backlight Operating Levels .....	14	Outline Dimensions .....	39
Backlight Maximum and Dim Settings .....	14	Ordering Guide .....	40

## REVISION HISTORY

### 4/12—Rev. A to Rev. B

Changes to Table 1 .....	4
Updated Outline Dimensions .....	40
Changes to Ordering Guide .....	40

### 6/10—Rev. 0 to Rev. A

Changes to Features Section and General Description Section ..	1
Changes to Thermal Resistance Section and Table 3 .....	5
Added Figure 4; Renumbered Sequentially .....	6
Changes to Table 4 .....	6
Changes to Layout Guidelines Section .....	19
Updated Outline Dimensions .....	39
Changes to Ordering Guide .....	40

### 4/10—Revision 0: Initial Version

## SPECIFICATIONS

$V_{IN} = 3.6\text{ V}$ ,  $SCL = 2.7\text{ V}$ ,  $SDA = 2.7\text{ V}$ ,  $nINT = \text{open}$ ,  $nRST = 2.7\text{ V}$ ,  $V_{D1:D7} = 0.4\text{ V}$ , Capacitor  $C1 = 1\ \mu\text{F}$ , Capacitor  $C2 = 1\ \mu\text{F}$ ,  $C_{OUT} = 1\ \mu\text{F}$ , typical values are at  $T_A = 25^\circ\text{C}$  and are not guaranteed, minimum and maximum limits are guaranteed from  $T_A = -40^\circ\text{C}$  to  $+85^\circ\text{C}$ , unless otherwise noted.

Table 1.

Parameter	Symbol	Test Conditions/Comments	Min	Typ	Max	Unit
<b>SUPPLY</b>						
Input Voltage						
Operating Range	$V_{IN}$		2.5		5.5	V
Start-Up Level	$V_{IN(START)}$	$V_{IN}$ increasing		2.05	2.30	V
Low Level	$V_{IN(STOP)}$	$V_{IN}$ decreasing	1.75	1.97		V
$V_{IN(START)}$ Hysteresis	$V_{IN(HYS)}$	After startup		80		mV
UVLO Noise Filter	$t_{UVLO}$			10		$\mu\text{s}$
Quiescent Current	$I_Q$					
Prior to $V_{IN(START)}$	$I_{Q(START)}$	$V_{IN} = V_{IN(START)} - 100\text{ mV}$		10		$\mu\text{A}$
During Standby	$I_{Q(STBY)}$	$V_{IN} = 3.6\text{ V}$ , Bit $nSTBY = 0$ , $SCL = SDA = 0\text{ V}$		0.3	1.0	$\mu\text{A}$
After Startup and Switching	$I_{Q(ACTIVE)}$	$V_{IN} = 3.6\text{ V}$ , Bit $nSTBY = 1$ , $I_{OUT} = 0\text{ mA}$ , gain = $2\times$		4.5	7.2	$\text{mA}$
<b>OSCILLATOR</b>						
Switching Frequency	$f_{SW}$	Charge pump gain = $2\times$	0.8	1	1.32	MHz
Duty Cycle	D			50		%
<b>OUTPUT CURRENT CONTROL</b>						
Maximum Drive Current	$I_{D1:D7(MAX)}$	$V_{D1:D7} = 0.4\text{ V}$				
Diode 1 to Diode 7		Bit $SCR = 0$ in the $ISC7$ register				
$T_J = 25^\circ\text{C}$			26.2	30	34.1	$\text{mA}$
$T_J = -40^\circ\text{C}$ to $+85^\circ\text{C}$			24.4		34.1	$\text{mA}$
Diode 7 Only (60 mA Setting)	$I_{D7(60\text{ mA})}$	$V_{D7} = 0.4\text{ V}$ , Bit $SCR = 1$ in the $ISC7$ register				
$T_J = 25^\circ\text{C}$			52.5	60	67	$\text{mA}$
$T_J = -40^\circ\text{C}$ to $+85^\circ\text{C}$			48.8		67	$\text{mA}$
LED Current Source Matching <sup>1</sup>	$I_{MATCH}$					
All Current Sinks	$I_{MATCH7}$	$V_{D1:D7} = 0.4\text{ V}$		2.0		%
Diode 2 to Diode 7 Current Sinks	$I_{MATCH6}$	$V_{D2:D7} = 0.4\text{ V}$		1.5		%
Leakage Current on LED Pins	$I_{D1:D7(LKG)}$	$V_{IN} = 5.5\text{ V}$ , $V_{D1:D7} = 2.5\text{ V}$ , Bit $nSTBY = 1$			0.5	$\mu\text{A}$
Equivalent Output Resistance	$R_{OUT}$					
Gain = $1\times$		$V_{IN} = 3.6\text{ V}$ , $I_{OUT} = 100\text{ mA}$		0.5		$\Omega$
Gain = $1.5\times$		$V_{IN} = 3.1\text{ V}$ , $I_{OUT} = 100\text{ mA}$		3.0		$\Omega$
Gain = $2\times$		$V_{IN} = 2.5\text{ V}$ , $I_{OUT} = 100\text{ mA}$		3.8		$\Omega$
Regulated Output Voltage	$V_{OUT(REG)}$	$V_{IN} = 3\text{ V}$ , gain = $2\times$ , $I_{OUT} = 10\text{ mA}$	4.3	4.9	5.5	V
<b>AUTOMATIC GAIN SELECTION</b>						
Minimum Voltage						
Gain Increases	$V_{HR(UP)}$	Decrease $V_{D1:D7}$ until the gain switches up	162	200	276	mV
Minimum Current Sink Headroom Voltage	$V_{HR(MIN)}$	$I_{DX} = I_{DX(MAX)} \times 95\%$		180		mV
Gain Delay	$t_{GAIN}$	The delay after gain has changed and before gain is allowed to change again		100		$\mu\text{s}$

Parameter	Symbol	Test Conditions/Comments	Min	Typ	Max	Unit
<b>FAULT PROTECTION</b>						
Start-Up Charging Current Source	$I_{SS}$	$V_{IN} = 3.6\text{ V}, V_{OUT} = 0.8 \times V_{IN}$	2.5	3.75	5.5	mA
Output Voltage Threshold	$V_{OUT}$					
Exit Soft Start	$V_{OUT(START)}$	$V_{OUT}$ rising		$0.92 \times V_{IN}$		V
Short-Circuit Protection	$V_{OUT(SC)}$	$V_{OUT}$ falling		$0.55 \times V_{IN}$		V
Output Overvoltage Protection	$V_{OVP}$					
Activation Level				5.8		V
OVP Recovery Hysteresis				500		mV
Thermal Shutdown						
Threshold	TSD			150		°C
Hysteresis	$TSD_{(HYS)}$			20		°C
Isolation from Input to Output During Fault	$I_{OUTLKG}$	$V_{IN} = 5.5\text{ V}, V_{OUT} = 0\text{ V}, \text{Bit } nSTBY = 0$			1.5	μA
Time to Validate a Fault	$t_{FAULT}$			2		μs
<b>I<sup>2</sup>C INTERFACE</b>						
Operating $V_{DDIO}$ Voltage	$V_{DDIO}$				5.5	V
Logic Low Input <sup>2</sup>	$V_{IL}$	$V_{IN} = 2.5\text{ V}$			0.5	V
Logic High Input <sup>3</sup>	$V_{IH}$	$V_{IN} = 5.5\text{ V}$	1.55			V
<b>I<sup>2</sup>C TIMING SPECIFICATIONS</b>						
Delay from Reset Deassertion to I <sup>2</sup> C Access	$t_{RESET}$	Guaranteed by design			20	μs
SCL Frequency	$f_{SCL}$				400	kHz
SCL High Time	$t_{HIGH}$		0.6			μs
SCL Low Time	$t_{LOW}$		1.3			μs
Setup Time						
Data	$t_{SU, DAT}$		100			ns
Repeated Start	$t_{SU, STA}$		0.6			μs
Stop Condition	$t_{SU, STO}$		0.6			μs
Hold Time						
Data	$t_{HD, DAT}$		0		0.9	μs
Start/Repeated Start	$t_{HD, STA}$		0.6			μs
Bus Free Time (Stop and Start Conditions)	$t_{BUF}$		1.3			μs
Rise Time (SCL and SDA)	$t_R$		$20 + 0.1 C_B$		300	ns
Fall Time (SCL and SDA)	$t_F$				300	ns
Pulse Width of Suppressed Spike	$t_{SP}$		0		50	ns
Capacitive Load per Bus Line	$C_B$				400	pF

<sup>1</sup> Current source matching is calculated by dividing the difference between the maximum and minimum currents from the sum of the maximum and minimum.

<sup>2</sup>  $V_{IL}$  is a function of the input voltage. See Figure 16 in the Typical Performance Characteristics section for typical values over operating ranges.

<sup>3</sup>  $V_{IH}$  is a function of the input voltage. See Figure 16 in the Typical Performance Characteristics section for typical values over operating ranges.

**I<sup>2</sup>C TIMING DIAGRAM**

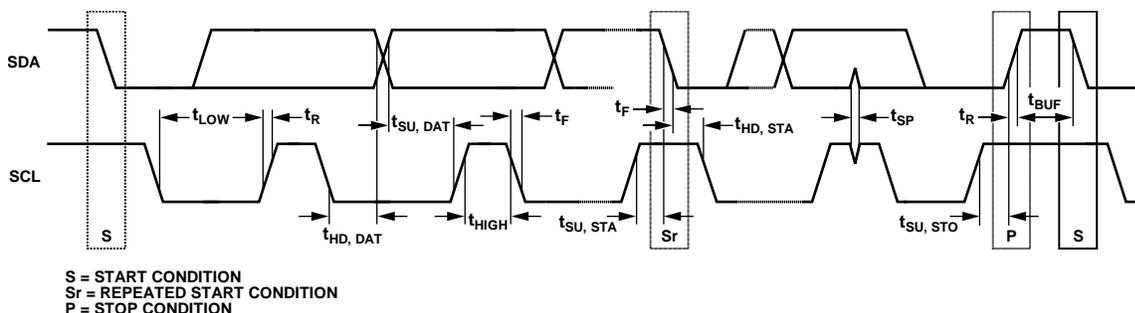

Figure 2. I<sup>2</sup>C Interface Timing Diagram

## ABSOLUTE MAXIMUM RATINGS

Table 2.

Parameter	Rating
VIN, VOUT	–0.3 V to +6 V
D1, D2, D3, D4, D5, D6, and D7	–0.3 V to +6 V
nINT, nRST, SCL, and SDA	–0.3 V to +6 V
Output Short-Circuit Duration	Indefinite
Operating Temperature Range	
Ambient (T <sub>A</sub> )	–40°C to +85°C <sup>1</sup>
Junction (T <sub>J</sub> )	–40°C to +125°C
Storage Temperature Range	–65°C to +150°C
Soldering Conditions	JEDEC J-STD-020
ESD (Electrostatic Discharge)	
Human Body Model (HBM)	±3 kV
Charged Device Model (CDM)	±1.5 kV

<sup>1</sup> The maximum operating junction temperature (T<sub>J(MAX)</sub>) takes precedence over the maximum operating ambient temperature (T<sub>A(MAX)</sub>). See the Maximum Temperature Ranges section for more information.

Stresses above those listed under Absolute Maximum Ratings may cause permanent damage to the device. This is a stress rating only; functional operation of the device at these or any other conditions above those indicated in the operational section of this specification is not implied. Exposure to absolute maximum rating conditions for extended periods may affect device reliability.

Absolute maximum ratings apply individually only, not in combination. Unless otherwise specified, all voltages are referenced to ground.

## MAXIMUM TEMPERATURE RANGES

The maximum operating junction temperature (T<sub>J(MAX)</sub>) takes precedence over the maximum operating ambient temperature (T<sub>A(MAX)</sub>). Therefore, in situations where the ADP8861 is exposed to poor thermal resistance and high power dissipation (P<sub>D</sub>), the maximum ambient temperature may need to be derated. In these cases, the maximum ambient temperature can be calculated with the following equation:

$$T_{A(MAX)} = T_{J(MAX)} - (\theta_{JA} \times P_{D(MAX)})$$

## THERMAL RESISTANCE

θ<sub>JA</sub> (junction to air) is specified for the worst-case conditions, that is, a device soldered in a circuit board for surface-mount packages. The θ<sub>JA</sub>, θ<sub>JB</sub> (junction to board), and θ<sub>JC</sub> (junction to case) are determined according to JE51-9 on a 4-layer printed circuit board (PCB) with natural convection cooling. For the LFCSP package, the exposed pad must be soldered to GND.

Table 3. Thermal Resistance

Package Type	θ <sub>JA</sub>	θ <sub>JB</sub>	θ <sub>JC</sub>	Unit
WLCSP	48	9	N/A <sup>1</sup>	°C/W
LFCSP	49.5	N/A <sup>1</sup>	5.3	°C/W

<sup>1</sup> N/A stands for not applicable.

## ESD CAUTION



**ESD (electrostatic discharge) sensitive device.** Charged devices and circuit boards can discharge without detection. Although this product features patented or proprietary protection circuitry, damage may occur on devices subjected to high energy ESD. Therefore, proper ESD precautions should be taken to avoid performance degradation or loss of functionality.

## PIN CONFIGURATIONS AND FUNCTION DESCRIPTIONS

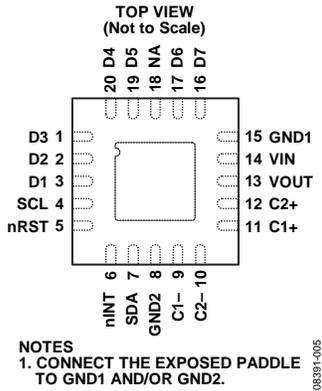

Figure 3. LFCSP Pin Configuration

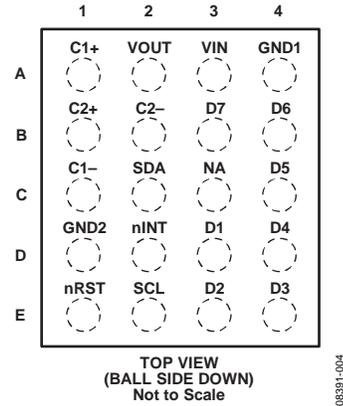

Figure 4. WLCSP Pin Configuration

Table 4. Pin Function Descriptions

Pin No.		Mnemonic	Description
LFCSP	WLCSP		
14	A3	VIN	Input Voltage, 2.5 V to 5.5 V.
3	D3	D1	LED Sink 1.
2	E3	D2	LED Sink 2.
1	E4	D3	LED Sink 3.
20	D4	D4	LED Sink 4.
19	C4	D5	LED Sink 5.
17	B4	D6	LED Sink 6.
16	B3	D7	LED Sink 7.
18	C3	NA	This pin is not used and must be connected to ground.
13	A2	VOUT	Charge Pump Output.
11	A1	C1+	Charge Pump C1+.
9	C1	C1-	Charge Pump C1-.
12	B1	C2+	Charge Pump C2+.
10	B2	C2-	Charge Pump C2-.
15	A4	GND1	Ground. Connect the exposed pad to GND1 and/or GND2.
8	D1	GND2	Ground. Connect the exposed pad to GND1 and/or GND2.
6	D2	nINT	Processor Interrupt (Active Low). Requires an external pull-up resistor. If this pin is not used, it can be left floating.
5	E1	nRST	Hardware Reset (Active Low). This pin resets the device to the default conditions. If not used, this pin must be tied above $V_{IH(MIN)}$ .
7	C2	SDA	I <sup>2</sup> C Serial Data. Requires an external pull-up resistor.
4	E2	SCL	I <sup>2</sup> C Clock. Requires an external pull-up resistor.
21	NA	EPAD	Exposed Paddle. Connect the exposed paddle to GND1 and/or GND2.

# TYPICAL PERFORMANCE CHARACTERISTICS

$V_{IN} = 3.6\text{ V}$ ,  $SCL = 2.7\text{ V}$ ,  $SDA = 2.7\text{ V}$ ,  $nRST = 2.7\text{ V}$ ,  $V_{D1:D7} = 0.4\text{ V}$ ,  $C_{IN} = 1\text{ }\mu\text{F}$ , Capacitor  $C1 = 1\text{ }\mu\text{F}$ , Capacitor  $C2 = 1\text{ }\mu\text{F}$ ,  $C_{OUT} = 1\text{ }\mu\text{F}$ ,  $T_A = 25^\circ\text{C}$ , unless otherwise noted.

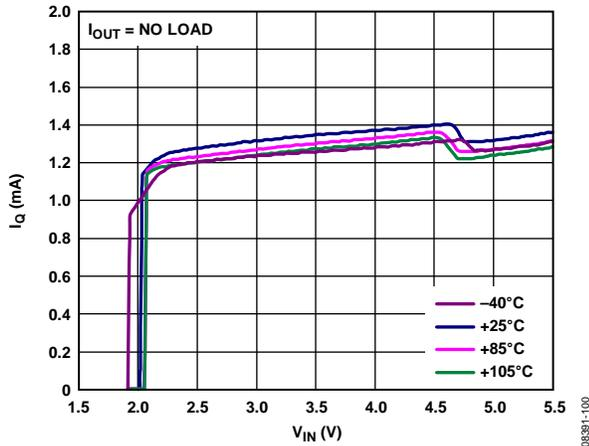

Figure 5. Typical Quiescent Current,  $G = 1\times$

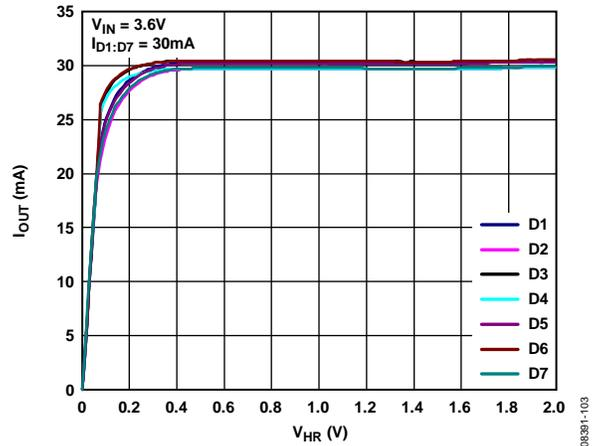

Figure 8. Typical Diode Current vs. Current Sink Headroom Voltage ( $V_{HR}$ )

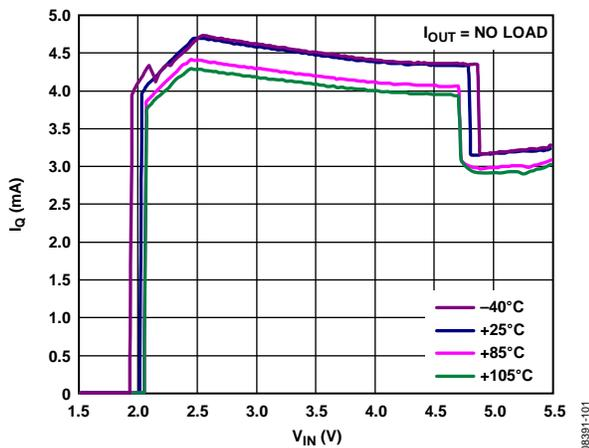

Figure 6. Typical Quiescent Current,  $G = 2\times$ ,  $I_{Q(ACTIVE)}$

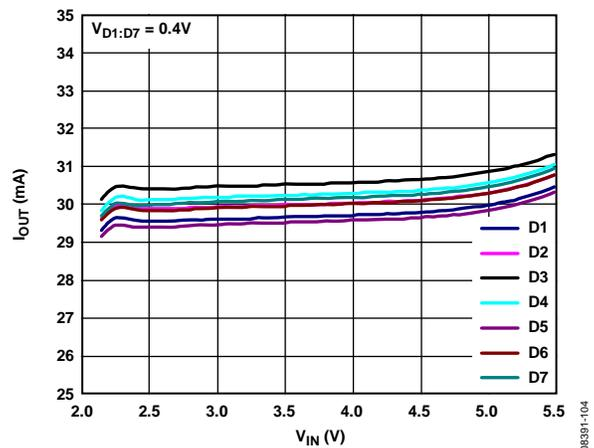

Figure 9. Typical Diode Current vs.  $V_{IN}$

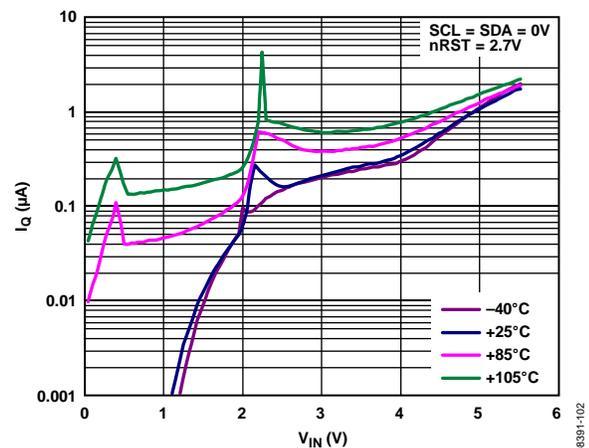

Figure 7. Typical Standby  $I_Q$  vs.  $V_{IN}$

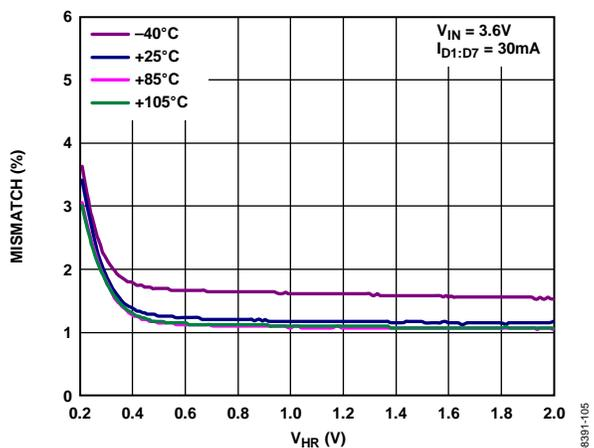

Figure 10. Typical Diode Matching vs. Current Sink Headroom Voltage ( $V_{HR}$ )

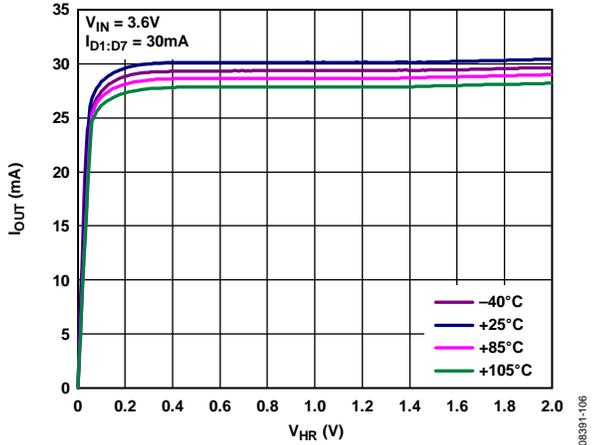

Figure 11. Typical Diode Current vs. Current Sink Headroom Voltage ( $V_{HR}$ )

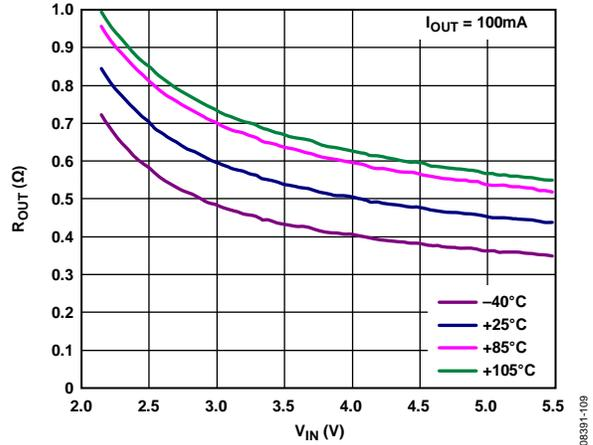

Figure 14. Typical  $R_{OUT}$  ( $G = 1\times$ ) vs.  $V_{IN}$

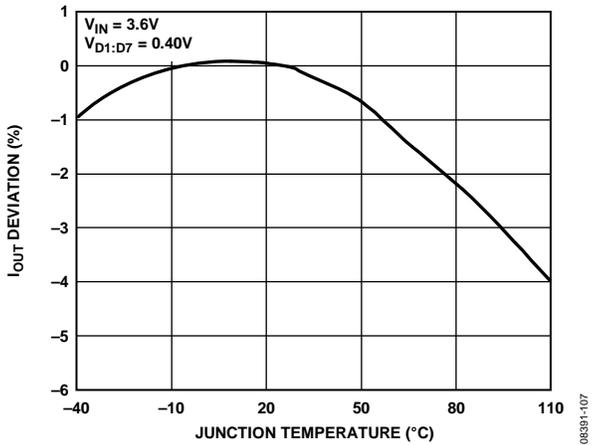

Figure 12. Typical Change In Diode Current vs. Temperature

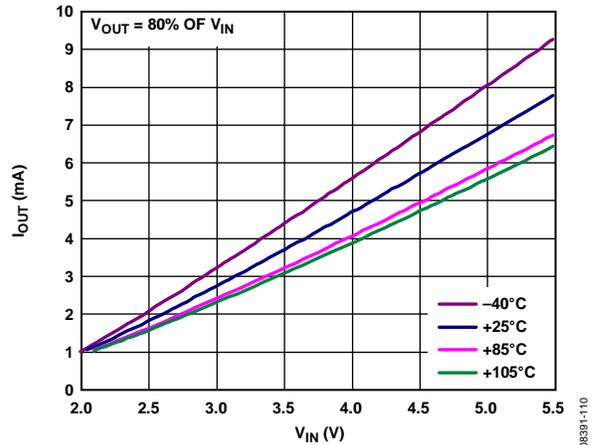

Figure 15. Typical Output Soft Start Current,  $I_{SS}$

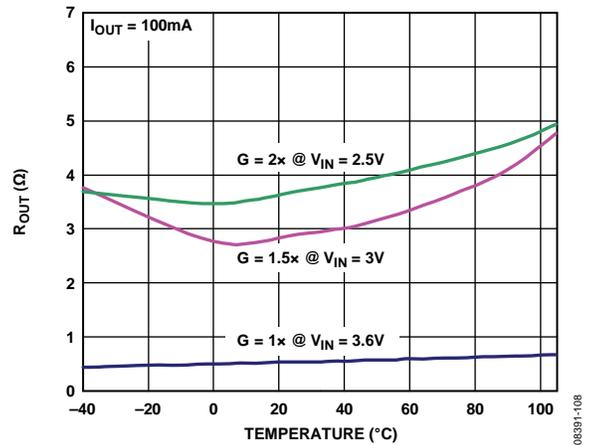

Figure 13.  $R_{OUT}$  vs. Temperature

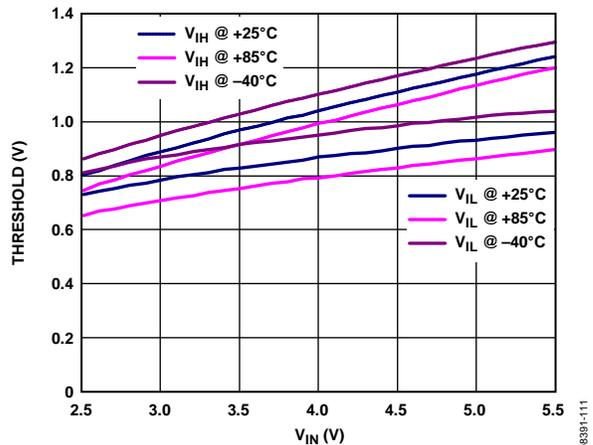

Figure 16. Typical  $P_C$  Thresholds,  $V_{IH}$  and  $V_{IL}$



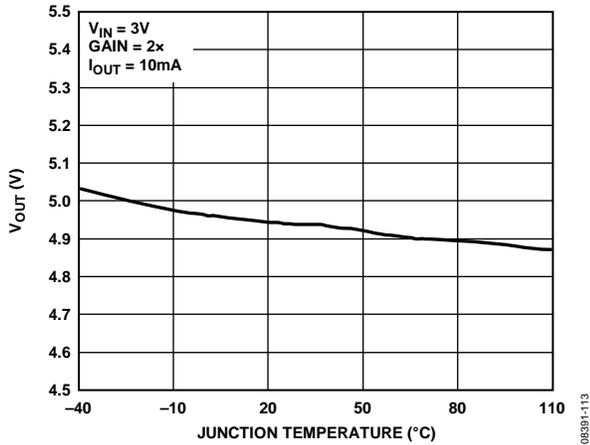

Figure 17. Typical Regulated Output Voltage ( $V_{OUT(REG)}$ )

08391-113

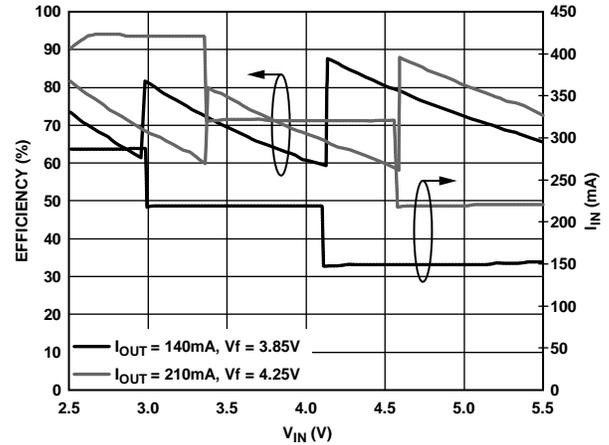

Figure 20. Typical Efficiency (High Vf Diode)

08391-116

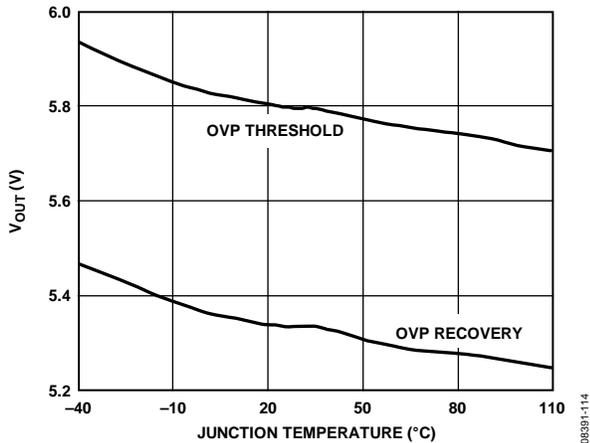

Figure 18. Typical Overvoltage Protection (OVP) Threshold

08391-114

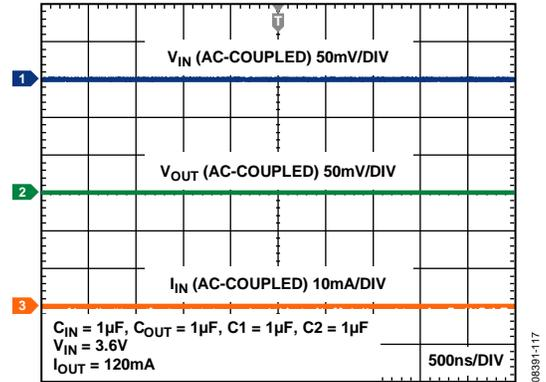

Figure 21. Typical Operating Waveforms,  $G = 1\times$

08391-117

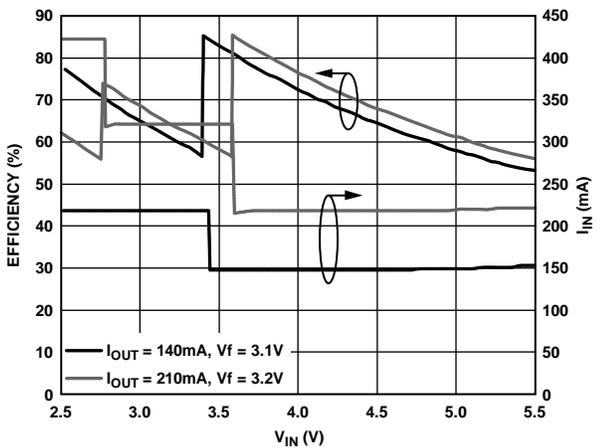

Figure 19. Typical Efficiency (Low Vf Diode)

08391-115

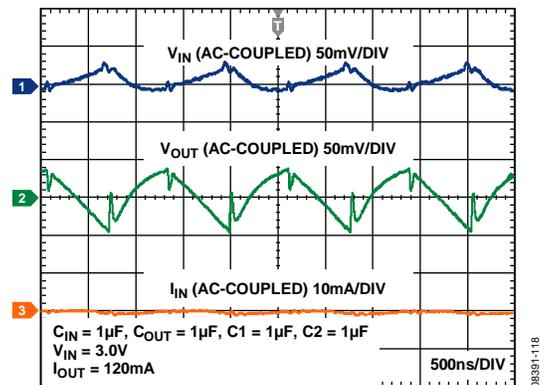

Figure 22. Typical Operating Waveforms,  $G = 1.5\times$

08391-118

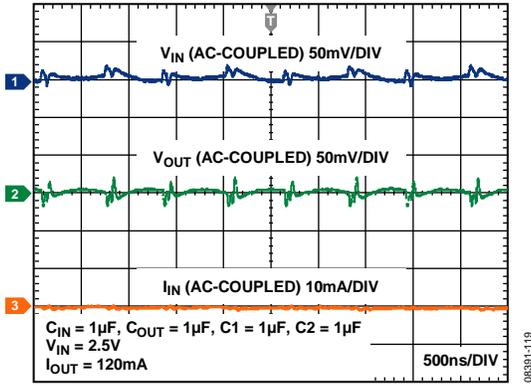

Figure 23. Typical Operating Waveforms,  $G = 2\times$

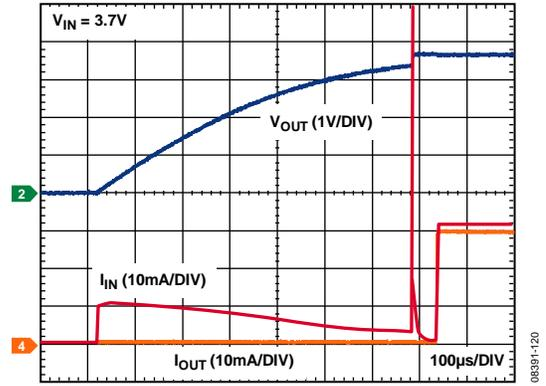

Figure 24. Typical Start-Up Waveform

### THEORY OF OPERATION

The ADP8861 provides a powerful charge pump driver with programmable LED control. Up to seven LEDs can be independently driven up to 30 mA (typical) each. The seventh LED can also be driven to 60 mA (typical). All LEDs can be individually programmed or combined into a group to operate backlight

LEDs. A full suite of safety features, including short-circuit, overvoltage, and overtemperature protection with input-to-output isolation, allows for a robust and safe design. The integrated soft start limits inrush currents at startup, restart attempts, and gain transitions.

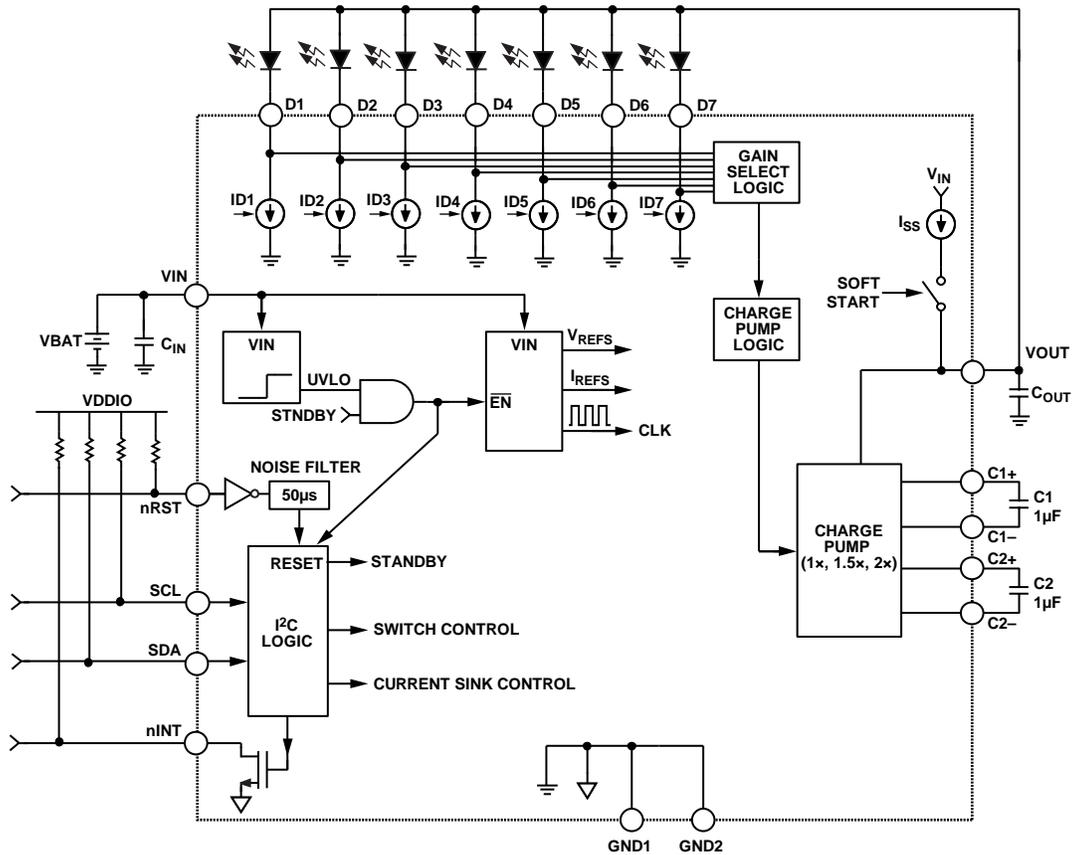

Figure 25. Detailed Block Diagram

08391-011

**POWER STAGE**

Because typical white LEDs require up to 4 V to drive them, some form of boosting is required over the typical variation in battery voltage. The ADP8861 accomplishes this with a high efficiency charge pump capable of producing a maximum  $I_{OUT}$  of 240 mA over the entire input voltage range (2.5 V to 5.5 V). Charge pumps use the basic principle that a capacitor stores charge based on the voltage applied to it, as shown in the following equation:

$$Q = C \times V \tag{1}$$

By charging the capacitors in different configurations, the charge, and therefore the gain, can be optimized to deliver the voltage required to power the LEDs. Because a fixed charging and discharging combination must be used, only certain multiples of gain are available. The ADP8861 is capable of automatically optimizing the gain (G) from 1×, 1.5×, and 2×. These gains are accomplished with two capacitors (labeled C1 and C2 in Figure 25) and an internal switching network.

In  $G = 1\times$  mode, the switches are configured to pass  $V_{IN}$  directly to  $V_{OUT}$ . In this mode, several switches are connected in parallel to minimize the resistive drop from input to output. In  $G = 1.5\times$  and  $2\times$  modes, the switches alternatively charge from the battery and discharge into the output. For  $G = 1.5\times$ , the capacitors are charged from  $V_{IN}$  in series and are discharged to  $V_{OUT}$  in parallel. For  $G = 2\times$ , the capacitors are charged from  $V_{IN}$

in parallel and are discharged to  $V_{OUT}$  in parallel. In certain fault modes, the switches are opened and the output is physically isolated from the input.

**Automatic Gain Selection**

Each LED that is driven requires a current source. The voltage on this current source must be greater than a minimum headroom voltage (180 mV typical) to maintain accurate current regulation. The gain is automatically selected based on the minimum voltage ( $V_{DX}$ ) at all of the current sources. At startup, the device is placed into  $G = 1\times$  mode and the output charges to  $V_{IN}$ . If any  $V_{D1:D7}$  level is less than the required headroom (180 mV), the gain is increased to the next step ( $G = 1.5\times$ ). A 100  $\mu s$  delay is allowed for the output to stabilize prior to the next gain switching decision. If there remains insufficient current sink headroom, then the gain is increased again to  $2\times$ . Conversely, to optimize efficiency, it is not desirable for the output voltage to be too high. Therefore, the gain reduces when the headroom voltage is great enough. This point (labeled  $V_{D_{MAX}}$  in Figure 26) is internally calculated to ensure that the lower gain still results in ample headroom for all the current sinks. The entire cycle is illustrated in Figure 26.

Note that the gain selection criteria apply only to active current sources. If current sources have been deactivated through an I<sup>2</sup>C command (for example only five LEDs are used), then the voltages on the deactivated current sources are ignored.

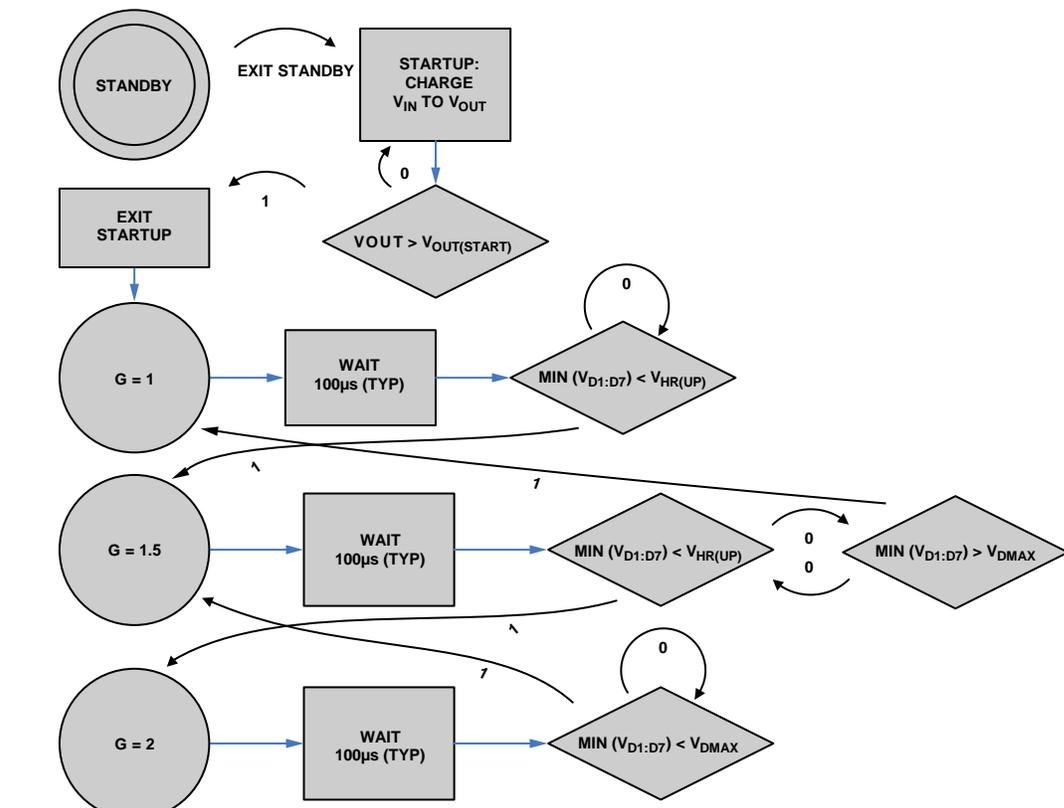

NOTES  
1.  $V_{D_{MAX}}$  IS THE CALCULATED GAIN DOWN TRANSITION POINT.

Figure 26. State Diagram for Automatic Gain Selection  
Rev. B | Page 12 of 40

0899-012

**Soft Start Feature**

At startup (either from UVLO activation or fault/standby recovery), the output is first charged by  $I_{SS}$  (3.75 mA typical) until it reaches about 92% of  $V_{IN}$ . This soft start feature reduces the inrush current that is otherwise present when the output capacitance is initially charged to  $V_{IN}$ . When this point is reached, the controller enters  $G = 1\times$  mode. If the output voltage is not sufficient, then the automatic gain selection determines the optimal point as defined in the Automatic Gain Selection section.

**OPERATING MODES**

There are four different operating modes: active, standby, shutdown, and reset.

**Active Mode**

In active mode, all circuits are powered up and in a fully operational state. This mode is entered when Bit nSTBY (in Register MDCR) is set to 1.

**Standby Mode**

Standby mode disables all circuitry except for the I<sup>2</sup>C receivers. Current consumption is reduced to less than 1  $\mu$ A. This mode is entered when the nSTBY bit is set to 0 or when the nRST pin is held low for more than 100  $\mu$ s (maximum). When standby is exited, a soft start sequence is performed.

**Shutdown Mode**

Shutdown mode disables all circuitry, including the I<sup>2</sup>C receivers. Shutdown occurs when  $V_{IN}$  is below the undervoltage thresholds. When  $V_{IN}$  rises above  $V_{IN(START)}$  (2.05 V typical), all registers are reset and the part is placed into standby mode.

**Reset Mode**

In reset mode, all registers are set to their default values and the part is placed into standby. There are two ways to reset the part: by power-on reset (POR) or using the nRST pin. POR is activated any time that the part exits shutdown mode. After a POR sequence is complete, the part automatically enters standby mode.

After startup, the part can be reset by pulling the nRST pin low. As long as the nRST pin is low, the part is held in a standby state but no I<sup>2</sup>C commands are acknowledged (all registers are kept at their default values). After releasing the nRST pin, all registers remain at their default values, and the part remains in standby; however, the part does accept I<sup>2</sup>C commands.

The nRST pin has a 50  $\mu$ s (typical) noise filter to prevent inadvertent activation of the reset function. The nRST pin must be held low for this entire time to activate reset.

The operating modes function according to the timing diagram in Figure 27.

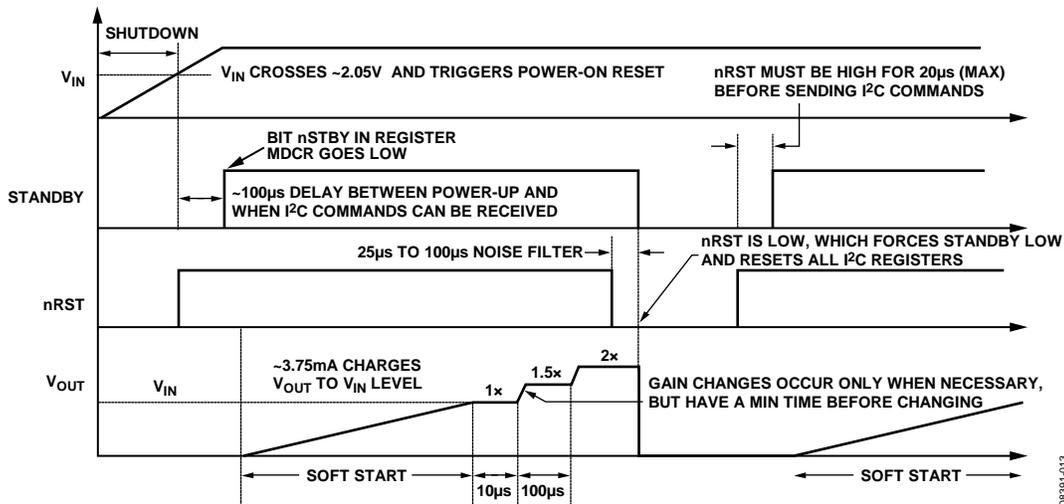

Figure 27. Typical Timing Diagram

08391-013

**BACKLIGHT OPERATING LEVELS**

The backlight can be operated at either the maximum level (Register 0x09) or the dim level (Register 0x0A). The backlight maximum and dim current settings are determined by a 7-bit code programmed by the user into these registers. The 7-bit resolution allows the user to set the backlight to one of 128 different levels between 0 mA and 30 mA.

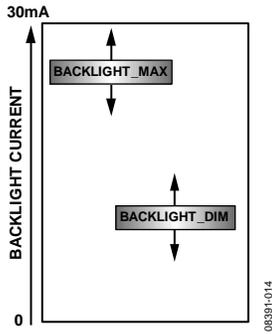

Figure 28. Backlight Operating Levels

The maximum and dim settings can be set between 0 mA and 30 mA; therefore, it is possible to program a dim setting that is greater than a maximum setting. For normal expected operation, ensure that the dim setting is programmed to be less than the maximum setting.

**BACKLIGHT MAXIMUM AND DIM SETTINGS**

The ADP8861 can implement two distinct algorithms to achieve a linear and a nonlinear relationship between input code and backlight current. The law bits in Register 0x04 are used to change between these algorithms.

By default, the ADP8861 uses a linear algorithm (law = 00), where the backlight current increases linearly for a corresponding increase in input code. Backlight current (in milliamperes) is determined by the following equation:

$$\text{Backlight Current (mA)} = \text{Code} \times (\text{Full-Scale Current}/127) \quad (2)$$

where:

*Code* is the input code programmed by the user.

*Full-Scale Current* is the maximum sink current allowed per LED (typically 30 mA).

The ADP8861 can also implement a nonlinear (square approximation) relationship between input code and backlight current level. In this case (law = 01), the backlight current (in milliamperes) is determined by the following equation:

$$\text{Backlight Current (mA)} = \left( \text{Code} \times \frac{\sqrt{\text{Full-Scale Current}}}{127} \right)^2 \quad (3)$$

Figure 29 shows the backlight current level vs. input code for both the linear and square law algorithms.

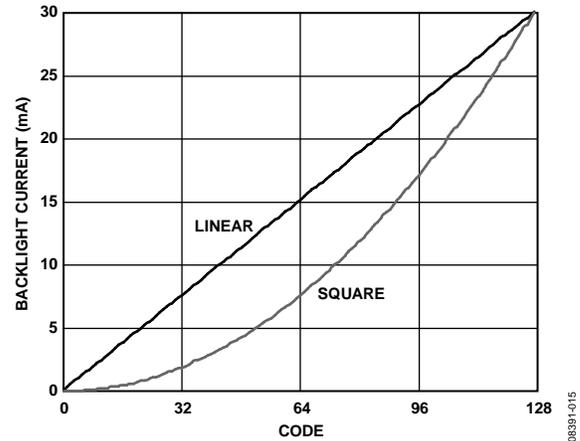

Figure 29. Backlight Current vs. Input Code

**AUTOMATED FADE IN AND FADE OUT**

The LED drivers are easily configured for automated fade in and fade out. Sixteen fade in and fade out rates can be selected via the I<sup>2</sup>C interface. Fade in and fade out rates range from 0.1 sec to 5.5 sec (per full-scale current, either 30 mA or 60 mA).

**Table 5. Available Fade In and Fade Out Rates**

Code	Fade Rate (in sec per Full-Scale Current)
0000	0.1 (disabled)
0001	0.3
0010	0.6
0011	0.9
0100	1.2
0101	1.5
0110	1.8
0111	2.1
1000	2.4
1001	2.7
1010	3.0
1011	3.5
1100	4.0
1101	4.5
1110	5.0
1111	5.5

The fade profile is based on the transfer law selected (linear, square, Cubic 10, or Cubic 11) and the delta between the actual current and the target current. Smaller changes in current reduce the fade time. For linear and square law fades, the fade time is given by

$$\text{Fade Time} = \text{Fade Rate} \times (\text{Code}/127) \quad (4)$$

where the *Fade Rate* is shown in Table 5.

The Cubic 10 and Cubic 11 laws also use the square law backlight currents derived from Equation 3; however, the time between each step is varied to produce a steeper slope at higher currents and a shallower slope at lower currents (see Figure 30).

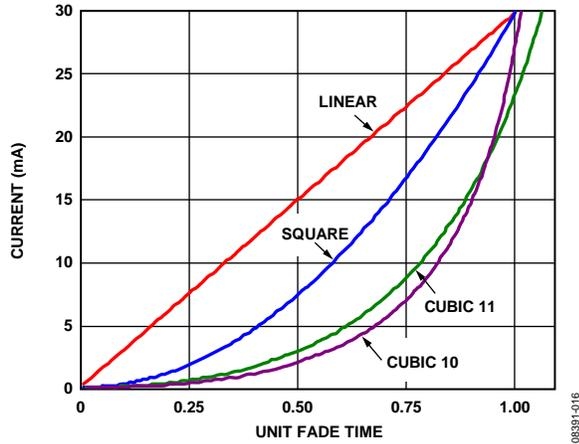

Figure 30. Comparison of the Dimming Transfers Laws

### BACKLIGHT TURN ON/TURN OFF/DIM

With the device in active mode ( $nSTBY = 1$ ), the backlight can be turned on using the  $BL\_EN$  bit in Register 0x01. Before turning on the backlight, the user should ensure that the maximum and dim settings are programmed. The backlight turns on when  $BL\_EN = 1$ . The backlight turns off when  $BL\_EN = 0$ .

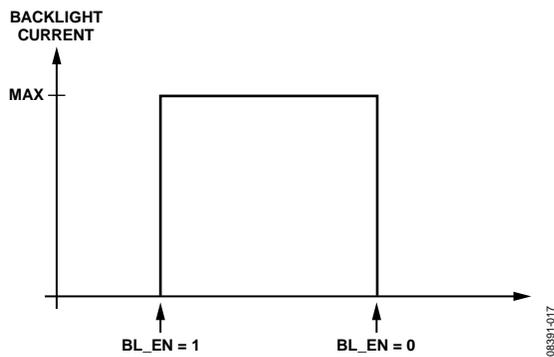

Figure 31. Backlight Turn On/Turn Off

While the backlight is on ( $BL\_EN = 1$ ), the user can change to the dim setting by programming  $DIM\_EN = 1$  in Register 0x01. If  $DIM\_EN = 0$ , the backlight reverts to its maximum setting.

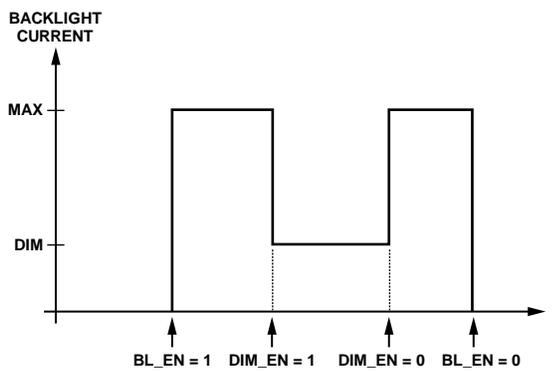

Figure 32. Backlight Turn On/Dim/Turn Off

### AUTOMATIC DIM AND TURN OFF TIMERS

The user can program the backlight to dim automatically by using the  $DIMT$  bits in Register 0x07. The dim timer has 127 settings ranging from 1 sec to 127 sec. Program the dim timer ( $DIMT$ ) before turning on the backlight. If  $BL\_EN = 1$ , the backlight turns on to its maximum setting and the dim timer starts counting. When the dim timer expires, the internal state machine sets  $DIM\_EN = 1$ , and the backlight enters its dim setting.

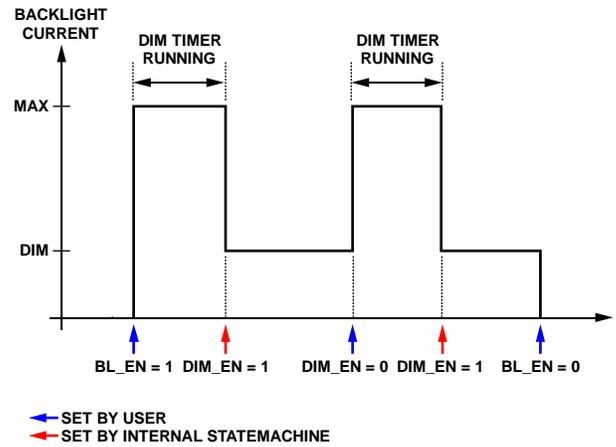

Figure 33. Dim Timer

If the user clears the  $DIM\_EN$  bit, the backlight reverts to its maximum setting and the dim timer begins counting again. When the dim timer expires, the internal state machine again sets  $DIM\_EN = 1$ , and the backlight enters its dim setting. The backlight can be turned off at any point during the dim timer countdown by clearing  $BL\_EN$ .

The user can also program the backlight to turn off automatically by using the  $OFFT$  bits in Register 0x06. The off timer has 127 settings ranging from 1 sec to 127 sec. Program the off timer ( $OFFT$ ) before turning on the backlight. If  $BL\_EN = 1$ , the backlight turns on to its maximum setting and the off timer starts counting. When the off timer expires, the internal state machine clears the  $BL\_EN$  bit, and the backlight turns off.

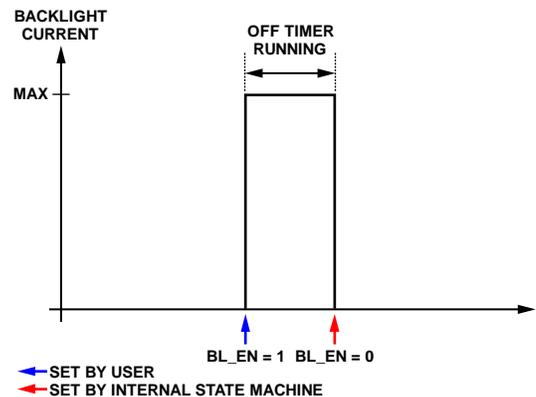

Figure 34. Off Timer

The backlight can be turned off at any point during the off timer countdown by clearing  $BL\_EN$ .

The dim timer and off timer can be used together for sequential maximum-to-dim-to-off functionality. With both the dim and off timers programmed, and BL\_EN asserted, the backlight turns on to its maximum setting, and when the dim timer expires, the backlight changes to its dim setting. When the off timer expires, the backlight turns off.

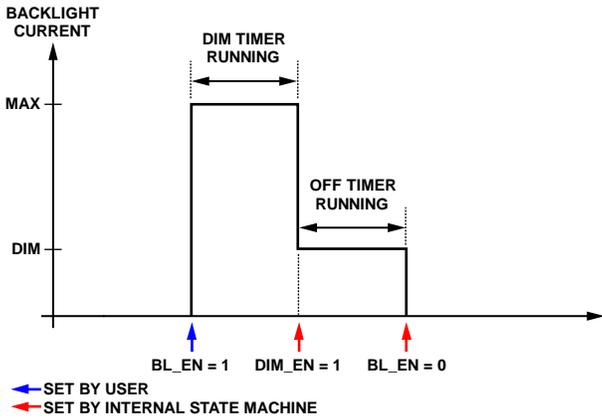

Figure 35. Dim and Off Timers Used Together

08391-021

**FADE OVERRIDE**

A fade override feature (FOVR in Register CFGR (0x04)) enables the host to override the preprogrammed fade in or fade out settings. If FOVR is set and the backlight is enabled in the middle of a fade out process, the backlight instantly (within approximately 100 ms) returns to its prefade brightness level. Alternatively, if the backlight is fading in, reasserting BL\_EN overrides the programmed fade in time, and the backlight instantly goes to its final fade value. This is useful for situations where a key is pressed during a fade sequence. However, if FOVR is cleared and the backlight is enabled in the middle of a fade process, the backlight gradually brightens from where it was interrupted (it does not go down to 0 and then comes back on).

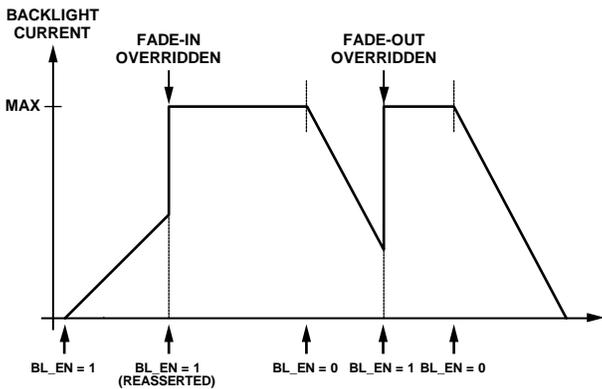

Figure 36. Fade Override Function (FOVR Is High)

08391-022

**INDEPENDENT SINK CONTROL**

Each of the seven LEDs can be configured (in Register 0x05) to operate as either part of the backlight or to operate as an independent sink current (ISC). Each ISC can be enabled independently and has its own current level. All ISCs share the same fade in rates, fade out rates, and fade law.

The ISCs have additional timers to facilitate blinking functions. A shared on timer (SCON) used in conjunction with the off timers of each ISC (SC1\_OFF, SC2\_OFF, SC3\_OFF, and SC4\_OFF in Register 0x12, and SC5\_OFF, SC6\_OFF, and SC7\_OFF in Register 0x11) allows the LED current sinks to be configured in various blinking modes. The on timer can be set to one of four different settings: 0.2 sec, 0.6 sec, 0.8 sec, or 1.2 sec. The off timers have four different settings: disabled, 0.6 sec, 1.2 sec, and 1.8 sec. Blink mode is activated by setting the off timers to any setting other than disabled.

Program all fade, on, and off timers before enabling any of the LED current sinks. If ISC<sub>x</sub> is on during a blink cycle and SC<sub>x</sub>\_EN is cleared, the LED turns off (or fades to off if fade out is enabled). If ISC<sub>x</sub> is off during a blink cycle and SC<sub>x</sub>\_EN is cleared, it stays off.

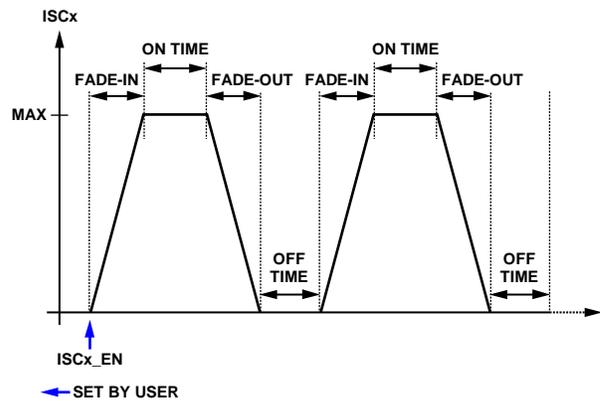

Figure 37. Independent Sink Blink Mode with Fading

08391-026

**SHORT-CIRCUIT PROTECTION MODE**

The ADP8861 can protect against short circuits on the output (VOUT). Short-circuit protection (SCP) is activated at the point when VOUT < 55% of VIN. Note that SCP sensing is disabled during both startup and restart attempts (fault recovery). SCP sensing is reenabled 4 ms (typical) after activation. During a short-circuit fault, the device enters a low current consumption state and an interrupt flag is set. The device can be restarted at any time after receiving a short-circuit fault by simply rewriting nSTBY = 1. It then repeats another complete soft start sequence. Note that the value of the output capacitance (COUT) should be small enough to allow VOUT to reach approximately 55% (typical) of VIN within the 4 ms (typical) time. If COUT is too large, the device inadvertently enters short-circuit protection.



## OVERVOLTAGE PROTECTION

Overvoltage protection (OVP) is implemented on the output. There are two types of overvoltage events: normal (no fault) and abnormal (from a fault or sudden load change).

### Normal Overvoltage

In a normal (no fault) overvoltage, the output voltage approaches  $V_{OUT(REG)}$  (4.9 V typical) during normal operation. This is not caused by a fault or load change, but it is simply a consequence of the input voltage times the gain reaching the same level as the clamped output voltage ( $V_{OUT(REG)}$ ). To prevent this type of overvoltage, the ADP8861 detects when the output voltage rises to  $V_{OUT(REG)}$ . It then increases the effective  $R_{OUT}$  of the gain stage to reduce the voltage that is delivered. This effectively regulates  $V_{OUT}$  to  $V_{OUT(REG)}$ ; however, there is a limit to the effect that this system can have on regulating  $V_{OUT}$ . It is designed only for normal operation and it is not intended to protect against faults or sudden load changes. When the output voltage is regulated to  $V_{OUT(REG)}$ , no interrupt is set and the operation is transparent to the LEDs and the overall application.

### Abnormal Overvoltage

Because of the open-loop behavior of the charge pump as well as how the gain transitions are computed, a sudden load change or fault can abnormally force  $V_{OUT}$  beyond 6 V. This causes an abnormal overvoltage situation. If the event happens slowly enough, the system first tries to regulate the output to 4.9 V as in a normal overvoltage scenario. However, if this is not sufficient, or if the event happens too quickly, then the ADP8861 enters OVP mode when  $V_{OUT}$  exceeds the OVP threshold (typically 5.8 V). In OVP mode, only the charge pump is disabled to prevent  $V_{OUT}$  from rising too high. The current sources and all other device functionality remain intact. When the output voltage falls by about 500 mV (to 5.3 V typical), the charge

pump resumes operation. If the fault or load event recurs, the process may repeat. An interrupt flag is set at each OVP instance.

## THERMAL SHUTDOWN/OVERTEMPERATURE PROTECTION

If the die temperature of the ADP8861 rises above a safe limit (150°C typical), the controllers enter thermal shutdown (TSD) protection mode. In this mode, most of the internal functions shut down, the part enters standby, and the TSD\_INT interrupt (Register 0x02) is set. When the die temperature decreases below ~130°C, the part can be restarted. To restart the part, simply remove it from standby. No interrupt is generated when the die temperature falls below 130°C. However, if the software clears the pending TSD\_INT interrupt and the temperature remains above 130°C, another interrupt is generated.

The complete state machine for these faults (SCP, OVP, and TSD) is shown in Figure 38.

## INTERRUPTS

There are three interrupt sources available on the ADP8861 in Register 0x02.

- Overvoltage protection: The OVP\_INT interrupt is generated when the output voltage exceeds 5.8 V (typical).
- Thermal shutdown circuit: An interrupt (TSD\_INT) is generated when entering overtemperature protection.
- Short-circuit detection: SHORT\_INT is generated when the device enters short-circuit protection mode.

The interrupt (if any) that appears on the nINT pin is determined by the bits mapped in Register INTR\_EN (0x03). To clear an interrupt, write a 1 to the interrupt in the MDCR2 register (0x02) or reset the part. Reading the interrupt, or writing a 0, has no effect.

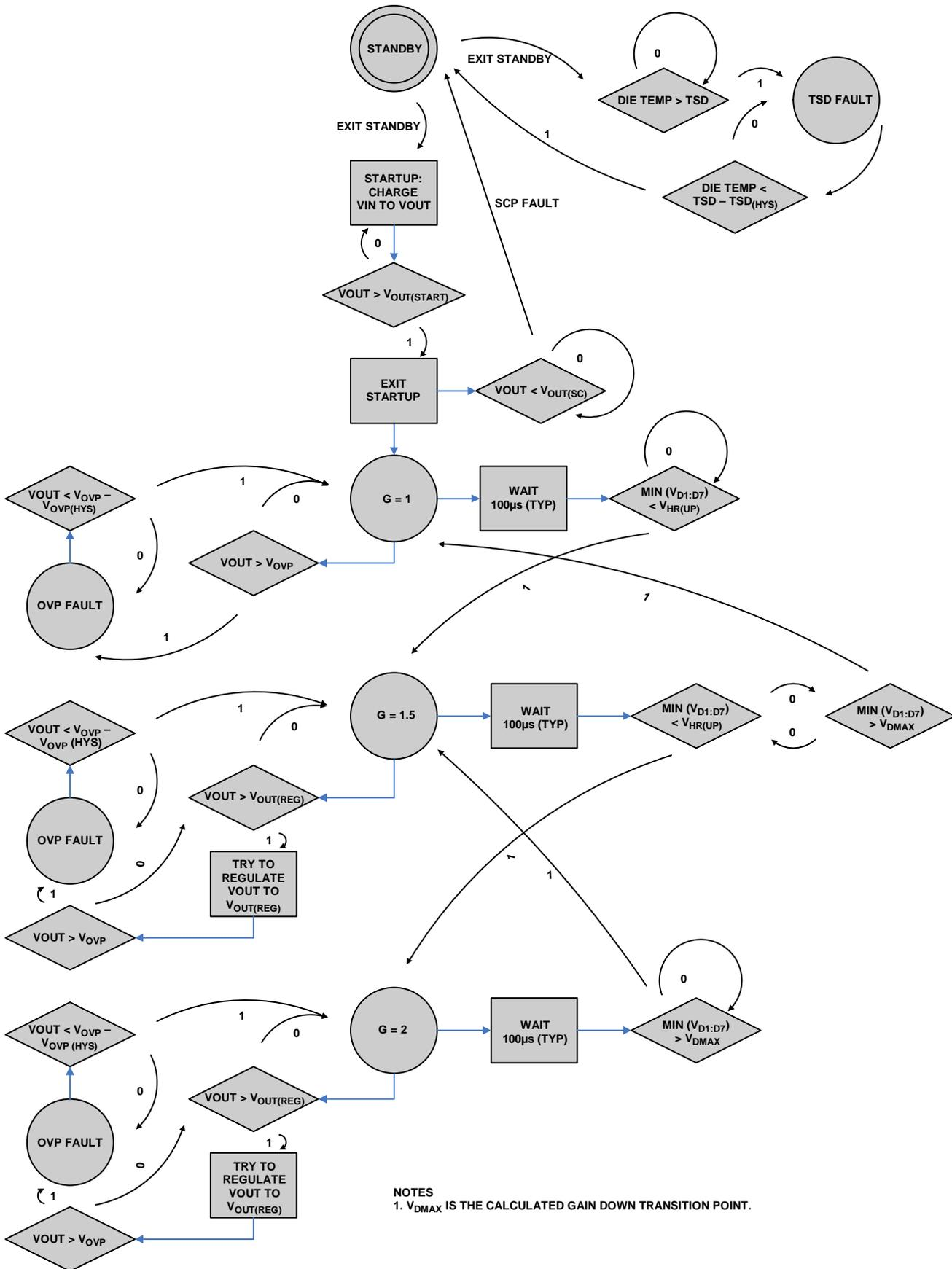

NOTES  
 1.  $V_{DMAX}$  IS THE CALCULATED GAIN DOWN TRANSITION POINT.

Figure 38. Fault State Machine  
 Rev. B | Page 18 of 40

## APPLICATIONS INFORMATION

The ADP8861 allows the charge pump to operate efficiently with a minimum of external components. Specifically, the user must select an input capacitor ( $C_{IN}$ ), output capacitor ( $C_{OUT}$ ), and two charge pump fly capacitors (C1 and C2).  $C_{IN}$  should be 1  $\mu\text{F}$  or greater. The value must be high enough to produce a stable input voltage signal at the minimum input voltage and maximum output load. A 1  $\mu\text{F}$  capacitor for  $C_{OUT}$  is recommended. Larger values are permissible, but care must be exercised to ensure that  $V_{OUT}$  charges above 55% (typical) of  $V_{IN}$  within 4 ms (typical). See the Short-Circuit Protection Mode section for more details.

For best practice, it is recommended that the two charge pump fly capacitors be 1  $\mu\text{F}$ ; larger values are not recommended, and smaller values may reduce the ability of the charge pump to deliver maximum current. For optimal efficiency, the charge pump fly capacitors should have low equivalent series resistance (ESR). Low ESR X5R or X7R capacitors are recommended for all four components. The use of fly capacitors sized 0402 and smaller is allowed, but the GDWN\_DIS bit in Register 0x01 must be set. Minimum voltage ratings should adhere to the guidelines in Table 6.

**Table 6. Capacitor Stress in Each Charge Pump Gain State**

Capacitor	Gain = 1x	Gain = 1.5x	Gain = 2x
$C_{IN}$	$V_{IN}$	$V_{IN}$	$V_{IN}$
$C_{OUT}$	$V_{IN}$	$V_{IN} \times 1.5$ (max of 5.5 V)	$V_{IN} \times 2.0$ (max of 5.5 V)
C1	None	$V_{IN}/2$	$V_{IN}$
C2	None	$V_{IN}/2$	$V_{IN}$

Any color LED can be used if the  $V_f$  (forward voltage) is less than 4.1 V. However, using lower  $V_f$  LEDs reduces the input power consumption by allowing the charge pump to operate at lower gain states.

The equivalent circuit model for a charge pump is shown in Figure 39.

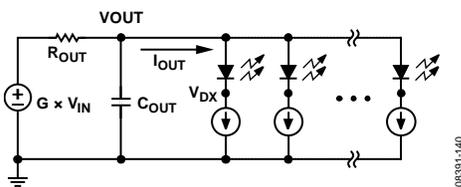

Figure 39. Charge Pump Equivalent Circuit Model

The input voltage is multiplied by the gain ( $G$ ) and delivered to the output through an effective resistance ( $R_{OUT}$ ). The output current flows through  $R_{OUT}$  and produces an IR drop to yield:

$$V_{OUT} = G \times V_{IN} - I_{OUT} \times R_{OUT}(G) \quad (5)$$

The  $R_{OUT}$  term is a combination of the  $R_{DS(ON)}$  resistance for the switches used in the charge pump and a small resistance, which accounts for the effective dynamic charge pump resistance. The  $R_{OUT}$  level changes based upon the gain (the configuration of the switches). Typical  $R_{OUT}$  values are given in Table 1, Figure 13, and Figure 14.

$V_{OUT}$  is also equal to the largest  $V_f$  of the LEDs used plus the voltage drop across the regulating current source. This gives

$$V_{OUT} = V_{f(MAX)} + V_{DX} \quad (6)$$

Combining Equation 5 and Equation 6 gives

$$V_{IN} = (V_{f(MAX)} + V_{DX} + I_{OUT} \times R_{OUT}(G))/G \quad (7)$$

Equation 7 is useful for calculating approximate bounds for the charge pump design.

## DETERMINING THE TRANSITION POINT OF THE CHARGE PUMP

Consider the following design example where:

$$V_{f(MAX)} = 3.7 \text{ V}$$

$$I_{OUT} = 140 \text{ mA (7 LEDs at 20 mA each)}$$

$$R_{OUT} (G = 1.5\times) = 3 \Omega \text{ (obtained from Figure 13)}$$

At the point of a gain transition,  $V_{DX} = V_{HR(UP)}$ . Table 1 gives the typical value of  $V_{HR(UP)}$  as 0.2 V. Therefore, the input voltage level when the gain transitions from 1.5x to 2x is

$$V_{IN} = (3.7 \text{ V} + 0.2 \text{ V} + 140 \text{ mA} \times 3 \Omega)/1.5 = 2.88 \text{ V}$$

## LAYOUT GUIDELINES

Note the following layout guidelines:

- For optimal noise immunity, place the  $C_{IN}$  and  $C_{OUT}$  capacitors as close to their respective pins as possible. These capacitors should share a short ground trace. If the LEDs are a significant distance from the  $V_{OUT}$  pin, another capacitor on  $V_{OUT}$ , placed closer to the LEDs, is advisable.
- For optimal efficiency, place the charge pump fly capacitors (C1 and C2) as close to the part as possible.
- The ADP8861 does not distinguish between power ground and analog ground. Therefore, both ground pins can be connected directly together. It is recommended that these ground pins be connected at the ground for the input and output capacitors.
- The LFCSP package requires the exposed pad to be soldered at the board to the GND1 and/or GND2 pin(s).
- Unused diode pins (Pin D1 to Pin D7) can be connected to ground or to  $V_{OUT}$ , or remain floating. However, the unused diode current sinks must be disabled by setting them as independent sinks in Register 0x05 and then disabling them in Register 0x10. If they are not disabled, the charge pump efficiency may suffer.
- If the interrupt pin (nINT) is not used, connect it to ground or leave it floating. Never connect it to a voltage supply, except through a  $\geq 1 \text{ k}\Omega$  series resistor.
- The ADP8861 has an integrated noise filter on the nRST pin. Under normal conditions, it is not necessary to filter the reset line. However, if the part is exposed to an unusually noisy signal, it is beneficial to add a small RC filter or bypass capacitor on this pin. If the nRST pin is not used, it must be pulled well above the  $V_{IH(MIN)}$  level (see Table 1). Do not allow the nRST pin to float.

EXAMPLE CIRCUITS

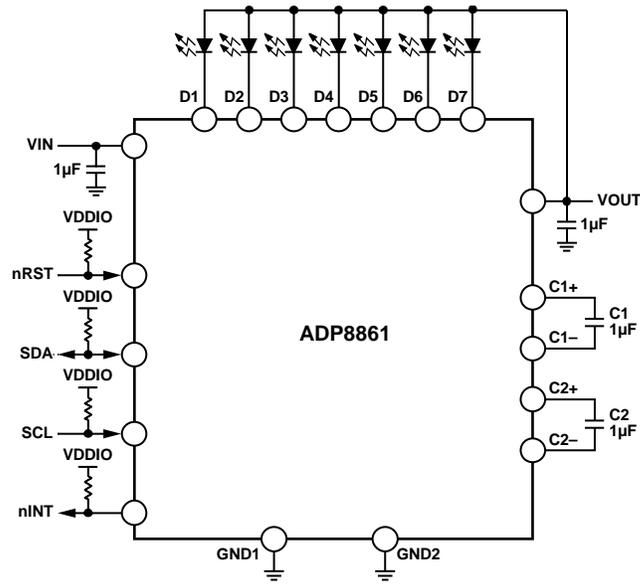

Figure 40. Generic Application Schematic

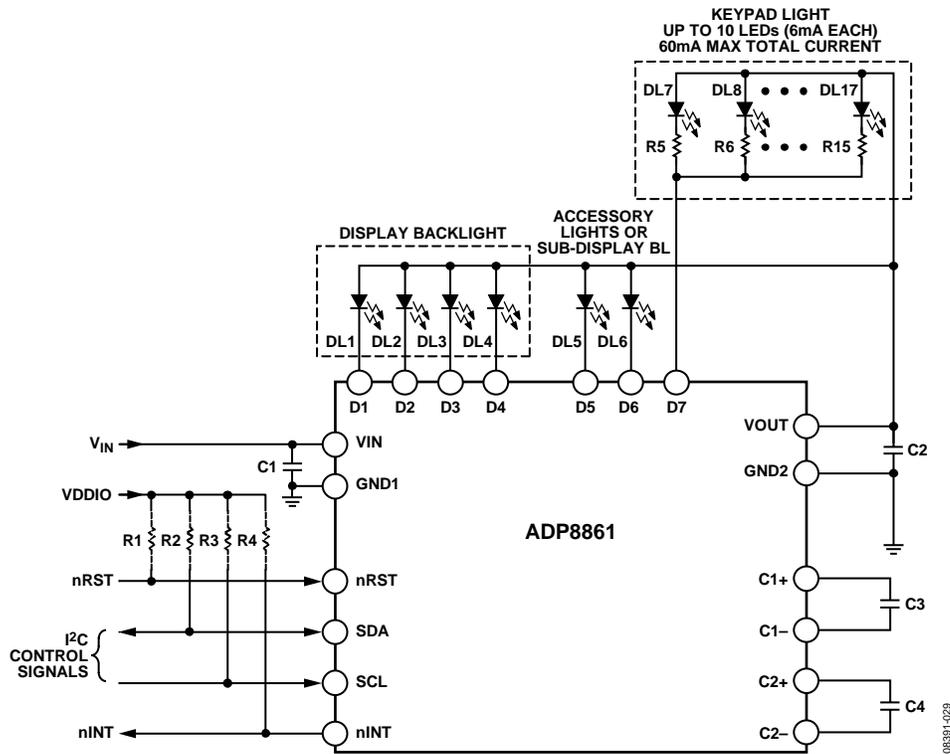

Figure 41. Application Schematic with Keypad Light Control

## I<sup>2</sup>C PROGRAMMING AND DIGITAL CONTROL

The ADP8861 provides full software programmability to facilitate its adoption in various product architectures. The default I<sup>2</sup>C address is 0101010x (x = 0 during write, x = 1 during read). Therefore, the default write address is 0x54 and the read address is 0x55.

Note the following general behavior of registers:

- All registers are set to their default values during reset or after a UVLO event.
- All registers are read/write unless otherwise specified.
- Unused bits are read as zero.

Table 7 through Table 55 provide register and bit descriptions. The reset value for all bits in the bit map tables is all 0s, except in Table 9 (see Table 9 for its unique reset value). Wherever the acronym N/A appears in the tables, it means not applicable.

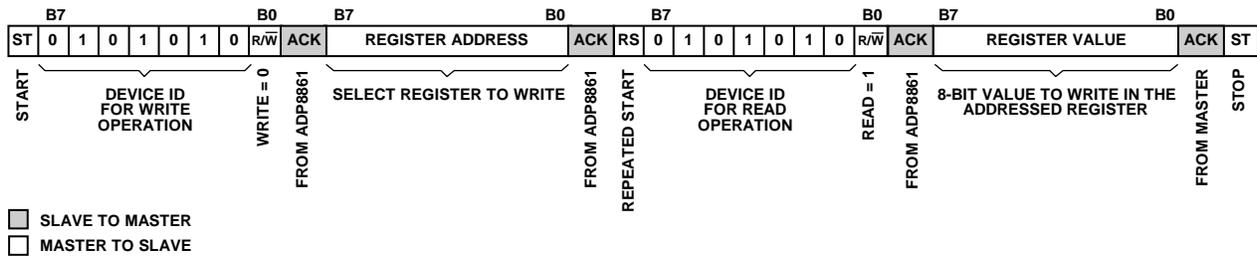

Figure 42. I<sup>2</sup>C Read Command Sequence

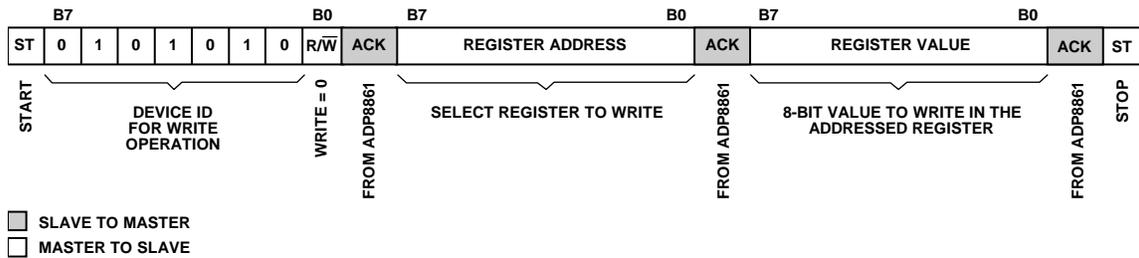

Figure 43. I<sup>2</sup>C Write Command Sequence

Table 7. Register Set Definitions

Address (Hex)	Register Name	Description
0x00	MFDVID	Manufacturer and device ID
0x01	MDCR	Device mode and status
0x02	MDCR2	Device mode and Status Register 2
0x03	INTR_EN	Interrupts enable
0x04	CFGR	Configuration register
0x05	BLSEN	Sink enable, backlight or independent
0x06	BLOFF	Backlight off timeout
0x07	BLDIM	Backlight dim timeout
0x08	BLFR	Backlight fade in and fade out rates
0x09	BLMX	Backlight maximum current
0x0A	BLDM	Backlight dim current
0x0B to 0x0E	Reserved	
0x0F	ISCFR	Independent sink current fade control register
0x10	ISCC	Independent sink current control register
0x11	ISCT1	Independent Sink Current Timer Register, LED[7:5]
0x12	ISCT2	Independent Sink Current Timer Register, LED[4:1]
0x13	ISCF	Independent sink current fade register
0x14	ISC7	Independent Sink Current, LED7
0x15	ISC6	Independent Sink Current, LED6
0x16	ISC5	Independent Sink Current, LED5
0x17	ISC4	Independent Sink Current, LED4
0x18	ISC3	Independent Sink Current, LED3
0x19	ISC2	Independent Sink Current, LED2
0x1A	ISC1	Independent Sink Current, LED1

Table 8. Register Map

Address (Hex)	Register Name	Bit 7	Bit 6	Bit 5	Bit 4	Bit 3	Bit 2	Bit 1	Bit 0	
0x00	MFDVID	Manufacturer ID				Device ID				
0x01	MDCR	Reserved	INT_CFG	nSTBY	DIM_EN	GDWN_DIS	SIS_EN	Reserved	BL_EN	
0x02	MDCR2	Reserved			SHORT_INT	TSD_INT	OVP_INT	Reserved		
0x03	INTR_EN	Reserved			SHORT_IEN	TSD_IEN	OVP_IEN	Reserved		
0x04	CFGR	Reserved					Law		FOVR	
0x05	BLSN	Reserved	D7EN	D6EN	D5EN	D4EN	D3EN	D2EN	D1EN	
0x06	BLOFF	Reserved	OFFT							
0x07	BLDIM	Reserved	DIMT							
0x08	BLFR	BL_FO				BL_FI				
0x09	BLMX	Reserved	BL_MC							
0x0A	BOLDM	Reserved	BL_DC							
0x0B to 0x0E	N/A	Reserved								
0x0F	ISCFR	Reserved						SC_LAW		
0x10	ISCC	Reserved	SC7_EN	SC6_EN	SC5_EN	SC4_EN	SC3_EN	SC2_EN	SC1_EN	
0x11	ISCT1	SCON		SC7_OFF		SC6_OFF		SC5_OFF		
0x12	ISCT2	SC4_OFF		SC3_OFF		SC2_OFF		SC1_OFF		
0x13	ISCF	SCFO				SCFI				
0x14	ISC7	SCR	SCD7							
0x15	ISC6	Reserved	SCD6							
0x16	ISC5	Reserved	SCD5							
0x17	ISC4	Reserved	SCD4							
0x18	ISC3	Reserved	SCD3							
0x19	ISC2	Reserved	SCD2							
0x1A	ISC1	Reserved	SCD1							

**Manufacturer and Device ID (MFDVID)—Register 0x00**

Multiple device revisions are tracked by the device ID field. This is a read-only register.

**Table 9. MFDVID Bit Map**

Bit 7	Bit 6	Bit 5	Bit 4	Bit 3	Bit 2	Bit 1	Bit 0
Manufacturer ID				Device ID			
0	1	0	0	0	0	0	0

**Mode Control Register (MDCR)—Register 0x01****Table 10. MDCR Bit Map**

Bit 7	Bit 6	Bit 5	Bit 4	Bit 3	Bit 2	Bit 1	Bit 0
Reserved	INT_CFG	nSTBY	DIM_EN	GDWN_DIS	SIS_EN	Reserved	BL_EN

**Table 11. Bit Descriptions for the MDCR Register**

Bit Name	Bit No.	Description
N/A	7	Reserved.
INT_CFG	6	Interrupt configuration. 1 = processor interrupt deasserts for 50 $\mu$ s and reasserts with pending events. 0 = processor interrupt remains asserted if the host tries to clear the interrupt while there is a pending event.
nSTBY	5	1 = device is in active mode. 0 = device is in standby mode; only the I <sup>2</sup> C interface is enabled.
DIM_EN	4	DIM_EN is set by the hardware after a dim timeout. The user can also force the backlight into dim mode by asserting this bit. Dim mode can only be entered if BL_EN is also enabled. 1 = backlight is operating at the dim current level (BL_EN must also be asserted). 0 = backlight is not in dim mode.
GDWN_DIS	3	1 = the charge pump does not switch down in gain until all LEDs are off. The charge pump switches up in gain as needed. This feature is useful if the ADP8861 charge pump is used to drive an external load. This feature must be used when utilizing small fly capacitors (0402 or smaller). 0 = the charge pump automatically switches up and down in gain. This provides optimal efficiency, but is not suitable for driving loads that are not connected through the ADP8861 diode drivers. Additionally, the charge pump fly capacitors should be low ESR and sized 0603 or greater.
SIS_EN	2	Synchronous independent sinks enable. 1 = enables all LED current sinks designated as independent sinks. This bit has no effect if any of the SCx_EN bits in Register 0x10 are set. 0 = disables all LED current sinks designated as independent sinks. This bit has no effect if any of the SCx_EN bits in Register 0x10 are set.
N/A	1	Reserved.
BL_EN	0	1 = backlight is enabled (nSTBY must also be asserted). 0 = backlight is disabled.



**Mode Control Register 2 (MDCR2)—Register 0x02**

Table 12. MDCR2 Bit Map

Bit 7	Bit 6	Bit 5	Bit 4	Bit 3	Bit 2	Bit 1	Bit 0
Reserved			SHORT_INT	TSD_INT	OVP_INT	Reserved	

Table 13. Bit Descriptions for the MDCR2 Register

Bit Name	Bit No.	Description <sup>1</sup>
N/A	[7:5]	Reserved
SHORT_INT	4	Short-circuit error interrupt. 1 = a short-circuit or overload condition on VOUT has been detected. 0 = no short-circuit or overload condition has been detected.
TSD_INT	3	Thermal shutdown interrupt. 1 = the device temperature has exceeded 150°C (typical). 0 = no overtemperature condition has been detected.
OVP_INT	2	Overvoltage interrupt. 1 = VOUT has exceeded V <sub>OVP</sub> . 0 = VOUT has not exceeded V <sub>OVP</sub> .
N/A	1:0	Reserved.

<sup>1</sup> Interrupt bits are cleared by writing a 1 to the flag; writing a 0 or reading the flag has no effect.

**Interrupt Enable (INTR\_EN)—Register 0x03**

Table 14. INTR\_EN Bit Map

Bit 7	Bit 6	Bit 5	Bit 4	Bit 3	Bit 2	Bit 1	Bit 0
Reserved			SHORT_IEN	TSD_IEN	OVP_IEN	Reserved	

Table 15. Bit Descriptions for the INTR\_EN Register

Bit Name	Bit No.	Description
N/A	[7:5]	Reserved.
SHORT_IEN	4	Short-circuit interrupt is enabled. When the SHORT_INT status bit is set after an error condition, an interrupt is raised to the host if the SHORT_IEN flag is enabled. 1 = the short-circuit interrupt is enabled. 0 = the short-circuit interrupt is disabled (the SHORT_INT flag continues to assert).
TSD_IEN	3	Thermal shutdown interrupt is enabled. When the TSD_INT status bit is set after an error condition, an interrupt is raised to the host if the TSD_IEN flag is enabled. 1 = the thermal shutdown interrupt is enabled. 0 = the thermal shutdown interrupt is disabled (the TSD_INT flag continues to assert).
OVP_IEN	2	Overvoltage interrupt enabled. When the OVP_INT status bit is set after an error condition, an interrupt is raised to the host if the OVP_IEN flag is enabled. 1 = the overvoltage interrupt is enabled. 0 = the overvoltage interrupt is disabled (the OVP_INT flag continues to assert).
N/A	[1:0]	Reserved.

**BACKLIGHT REGISTER DESCRIPTIONS****Configuration Register (CFGR)—Register 0x04**

Table 16. CFGR Bit Map

Bit 7	Bit 6	Bit 5	Bit 4	Bit 3	Bit 2	Bit 1	Bit 0
Reserved					Law		FOVR

Table 17. Bit Descriptions for the CFGR Register

Bit Name	Bit No.	Description
N/A	[7:3]	Reserved
Law	[2:1]	Backlight transfer law 00 = linear law DAC, linear time steps 01 = square law DAC, linear time steps 10 = square law DAC, nonlinear time steps (Cubic 10) 11 = square law DAC, nonlinear time steps (Cubic 11)
FOVR	0	Backlight fade override 1 = the backlight fade override is enabled 0 = the backlight fade override is disabled

**Backlight Sink Enable (BLSSEN)—Register 0x05**

Table 18. BLSSEN Bit Map

Bit 7	Bit 6	Bit 5	Bit 4	Bit 3	Bit 2	Bit 1	Bit 0
Reserved	D7EN	D6EN	D5EN	D4EN	D3EN	D2EN	D1EN

Table 19. Bit Descriptions for the BLSSEN Register

Bit Name	Bit No.	Description
N/A	7	Reserved
D7EN	6	Diode 7 backlight sink enable 1 = selects LED7 as an independent sink 0 = connects LED7 sink to backlight enable (BL_EN)
D6EN	5	Diode 6 backlight sink enable 1 = selects LED6 as an independent sink 0 = connects LED6 sink to backlight enable (BL_EN)
D5EN	4	Diode 5 backlight sink enable 1 = selects LED5 as an independent sink 0 = connects LED5 sink to backlight enable (BL_EN)
D4EN	3	Diode 4 backlight sink enable 1 = selects LED4 as an independent sink 0 = connects LED4 sink to backlight enable (BL_EN)
D3EN	2	Diode 3 backlight sink enable 1 = selects LED3 as an independent sink 0 = connects LED3 sink to backlight enable (BL_EN)
D2EN	1	Diode 2 backlight sink enable 1 = selects LED2 as an independent sink 0 = connects LED2 sink to backlight enable (BL_EN)
D1EN	0	Diode 1 backlight sink enable 1 = selects LED1 as an independent sink 0 = connects LED1 sink to backlight enable (BL_EN)

**Backlight Off Timeout (BLOFF)—Register 0x06**

Table 20. BLOFF Bit Map

Bit 7	Bit 6	Bit 5	Bit 4	Bit 3	Bit 2	Bit 1	Bit 0
Reserved	OFFT						

Table 21. Bit Descriptions for the BLOFF Register

Bit Name	Bit No.	Description
N/A	7	Reserved.
OFFT	[6:0]	Backlight off timeout. After the off timeout (OFFT) period, the backlight turns off. If the dim timeout (DIMIT) is enabled, the off timeout starts after the dim timeout. 0000000 = timeout disabled 0000001 = 1 sec 0000010 = 2 sec 0000011 = 3 sec ... 1111111 = 127 sec

**Backlight Dim Timeout (BLDIM)—Register 0x07**

Table 22. BLDIM Bit Map

Bit 7	Bit 6	Bit 5	Bit 4	Bit 3	Bit 2	Bit 1	Bit 0
Reserved	DIMIT						

Table 23. Bit Descriptions for the BLDIM Register

Bit Name	Bit No.	Description
N/A	7	Reserved.
DIMIT	[6:0]	Backlight dim timeout. After the dim timeout (DIMIT) period, the backlight is set to the dim current value. The dim timeout starts after backlight reaches the maximum current. 0000000 = timeout disabled 0000001 = 1 sec 0000010 = 2 sec 0000011 = 3 sec ... 1111111 = 127 sec

**Backlight Fade (BLFR)—Register 0x08**

Table 24. BLFR Bit Map

Bit 7	Bit 6	Bit 5	Bit 4	Bit 3	Bit 2	Bit 1	Bit 0
BL_FO				BL_FI			

Table 25. Bit Descriptions for the BLFR Register

Bit Name	Bit No.	Description
BL_FO	[7:4]	<p>Backlight fade out rate. If fade out is disabled (BL_FO = 0000), the backlight changes instantly (within 100 ms). If the fade out rate is set, the backlight fades from its current value to the dim or the off value. The times listed for BL_FO are for a full-scale fade out (30 mA to 0 mA). Fades between closer current values reduce the fade time. See the Automated Fade In and Fade Out section for more information.</p> <p>0000 = 0.1 sec (fade out disabled)<sup>1</sup></p> <p>0001 = 0.3 sec</p> <p>0010 = 0.6 sec</p> <p>0011 = 0.9 sec</p> <p>0100 = 1.2 sec</p> <p>0101 = 1.5 sec</p> <p>0110 = 1.8 sec</p> <p>0111 = 2.1 sec</p> <p>1000 = 2.4 sec</p> <p>1001 = 2.7 sec</p> <p>1010 = 3.0 sec</p> <p>1011 = 3.5 sec</p> <p>1100 = 4.0 sec</p> <p>1101 = 4.5 sec</p> <p>1110 = 5.0 sec</p> <p>1111 = 5.5 sec</p>
BL_FI	[3:0]	<p>Backlight fade in rate. If fade in is disabled (BL_FI = 0000), the backlight changes instantly (within 100 ms). If the fade in rate is set, the backlight fades from its current value to its maximum value when the backlight is turned on. The times listed for BL_FI are for a full-scale fade in (0 mA to 30 mA). Fades between closer current values reduce the fade time. See the Automated Fade In and Fade Out section for more information.</p> <p>0000 = 0.1 sec (fade in disabled)<sup>1</sup></p> <p>0001 = 0.3 sec</p> <p>0010 = 0.6 sec</p> <p>0011 = 0.9 sec</p> <p>...</p> <p>1111 = 5.5 sec</p>

<sup>1</sup> When fade in and fade out are disabled, the backlight does not instantly fade, but instead, fades rapidly within about 100 ms.

**Backlight Maximum Current Register (BLMX)—Register 0x09**

Table 26. BLMX Bit Map

Bit 7	Bit 6	Bit 5	Bit 4	Bit 3	Bit 2	Bit 1	Bit 0
Reserved	BL_MC						

Table 27. Bit Descriptions for the BLMX Register

Bit Name	Bit No.	Description		
N/A	7	Reserved.		
BL_MC	[6:0]	Backlight maximum current. The backlight maximum current can be set according to the linear or square law function (see Table 28 for a complete list of values).		
		<b>DAC</b>	<b>Linear Law (mA)</b>	<b>Square Law (mA)</b>
		0000000	0	0.000
		0000001	0.236	0.002
		0000010	0.472	0.007
		0000011	0.709	0.017
...	...	...		
1111111	30	30		

Table 28. Linear and Square Law Currents Per DAC Code (SCR = 0)

DAC Code	Linear Law (mA)	Square Law (mA) <sup>1</sup>	DAC Code	Linear Law (mA)	Square Law (mA) <sup>1</sup>
0x00	0	0.000	0x22	8.031	2.150
0x01	0.236	0.002	0x23	8.268	2.279
0x02	0.472	0.007	0x24	8.504	2.411
0x03	0.709	0.017	0x25	8.740	2.546
0x04	0.945	0.030	0x26	8.976	2.686
0x05	1.181	0.047	0x27	9.213	2.829
0x06	1.417	0.067	0x28	9.449	2.976
0x07	1.654	0.091	0x29	9.685	3.127
0x08	1.890	0.119	0x2A	9.921	3.281
0x09	2.126	0.151	0x2B	10.157	3.439
0x0A	2.362	0.186	0x2C	10.394	3.601
0x0B	2.598	0.225	0x2D	10.630	3.767
0x0C	2.835	0.268	0x2E	10.866	3.936
0x0D	3.071	0.314	0x2F	11.102	4.109
0x0E	3.307	0.365	0x30	11.339	4.285
0x0F	3.543	0.419	0x31	11.575	4.466
0x10	3.780	0.476	0x32	11.811	4.650
0x11	4.016	0.538	0x33	12.047	4.838
0x12	4.252	0.603	0x34	12.283	5.029
0x13	4.488	0.671	0x35	12.520	5.225
0x14	4.724	0.744	0x36	12.756	5.424
0x15	4.961	0.820	0x37	12.992	5.627
0x16	5.197	0.900	0x38	13.228	5.833
0x17	5.433	0.984	0x39	13.465	6.043
0x18	5.669	1.071	0x3A	13.701	6.257
0x19	5.906	1.163	0x3B	13.937	6.475
0x1A	6.142	1.257	0x3C	14.173	6.696
0x1B	6.378	1.356	0x3D	14.409	6.921
0x1C	6.614	1.458	0x3E	14.646	7.150
0x1D	6.850	1.564	0x3F	14.882	7.382
0x1E	7.087	1.674	0x40	15.118	7.619
0x1F	7.323	1.787	0x41	15.354	7.859
0x20	7.559	1.905	0x42	15.591	8.102
0x21	7.795	2.026	0x43	15.827	8.350

DAC Code	Linear Law (mA)	Square Law (mA) <sup>1</sup>
0x44	16.063	8.601
0x45	16.299	8.855
0x46	16.535	9.114
0x47	16.772	9.376
0x48	17.008	9.642
0x49	17.244	9.912
0x4A	17.480	10.185
0x4B	17.717	10.463
0x4C	17.953	10.743
0x4D	18.189	11.028
0x4E	18.425	11.316
0x4F	18.661	11.608
0x50	18.898	11.904
0x51	19.134	12.203
0x52	19.370	12.507
0x53	19.606	12.814
0x54	19.842	13.124
0x55	20.079	13.439
0x56	20.315	13.757
0x57	20.551	14.078
0x58	20.787	14.404
0x59	21.024	14.733
0x5A	21.260	15.066
0x5B	21.496	15.403
0x5C	21.732	15.743
0x5D	21.968	16.087
0x5E	22.205	16.435
0x5F	22.441	16.787
0x60	22.677	17.142
0x61	22.913	17.501

DAC Code	Linear Law (mA)	Square Law (mA) <sup>1</sup>
0x62	23.150	17.863
0x63	23.386	18.230
0x64	23.622	18.600
0x65	23.858	18.974
0x66	24.094	19.351
0x67	24.331	19.733
0x68	24.567	20.118
0x69	24.803	20.507
0x6A	25.039	20.899
0x6B	25.276	21.295
0x6C	25.512	21.695
0x6D	25.748	22.099
0x6E	25.984	22.506
0x6F	26.220	22.917
0x70	26.457	23.332
0x71	26.693	23.750
0x72	26.929	24.173
0x73	27.165	24.599
0x74	27.402	25.028
0x75	27.638	25.462
0x76	27.874	25.899
0x77	28.110	26.340
0x78	28.346	26.784
0x79	28.583	27.232
0x7A	28.819	27.684
0x7B	29.055	28.140
0x7C	29.291	28.599
0x7D	29.528	29.063
0x7E	29.764	29.529
0x7F	30.000	30.000

<sup>1</sup> Cubic 10 and Cubic 11 laws use the square law DAC setting but vary the time step per DAC code (see Figure 30).

**Backlight Dim Current Register (BLDM)—Register 0x0A**

Table 29. BLDM Bit Map

Bit 7	Bit 6	Bit 5	Bit 4	Bit 3	Bit 2	Bit 1	Bit 0
Reserved	BL_DC						

Table 30. Bit Descriptions for the BLDM Register

Bit Name	Bit No.	Description
N/A	7	Reserved.
BL_DC	[6:0]	Backlight dim current. The backlight is set to the dim current value after a dim timeout or if the DIM_EN flag is set by the user (see Table 28 for a complete list of values).
		<b>DAC</b>
		<b>Linear Law (mA)</b>
		<b>Square Law (mA)</b>
		0000000
0000001	0.236	0.002
0000010	0.472	0.007
0000011	0.709	0.017
...	...	...
1111111	30	30

**INDEPENDENT SINK REGISTER DESCRIPTIONS****Independent Sink Current Fade Control Register (ISCFR)—Register 0x0F**

Table 31. ISCFR Bit Map

Bit 7	Bit 6	Bit 5	Bit 4	Bit 3	Bit 2	Bit 1	Bit 0
Reserved						SC_LAW	

Table 32. Bit Descriptions for the ISCFR

Bit Name	Bit No.	Description
N/A	[7:2]	Reserved
SC_LAW	[1:0]	Independent sink current fade transfer law 00 = linear law DAC, linear time steps 01 = square law DAC, linear time steps 10 = square law DAC, nonlinear time steps (Cubic 10) 11 = square law DAC, nonlinear time steps (Cubic 11)

**Independent Sink Current Control (ISCC)—Register 0x10**

Table 33. ISCC Bit Map

Bit 7	Bit 6	Bit 5	Bit 4	Bit 3	Bit 2	Bit 1	Bit 0
Reserved	SC7_EN	SC6_EN	SC5_EN	SC4_EN	SC3_EN	SC2_EN	SC1_EN

Table 34. Bit Descriptions for the ISCC Register

Bit Name	Bit No.	Description
N/A	7	Reserved
SC7_EN	6	This enable acts upon LED7 1 = SC7 is turned on 0 = SC7 is turned off
SC6_EN	5	This enable acts upon LED6 1 = SC6 is turned on 0 = SC6 is turned off
SC5_EN	4	This enable acts upon LED5 1 = SC5 is turned on 0 = SC5 is turned off

Bit Name	Bit No.	Description
SC4_EN	3	This enable acts upon LED4 1 = SC4 is turned on 0 = SC4 is turned off
SC3_EN	2	This enable acts upon LED3 1 = SC3 is turned on 0 = SC3 is turned off
SC2_EN	1	This enable acts upon LED2 1 = SC2 is turned on 0 = SC2 is turned off
SC1_EN	0	This enable acts upon LED1 1 = SC1 is turned on 0 = SC1 is turned off

### Independent Sink Current Time (ISCT1)—Register 0x11

Table 35. ISCT1 Bit Map

Bit 7	Bit 6	Bit 5	Bit 4	Bit 3	Bit 2	Bit 1	Bit 0
SCON		SC7_OFF		SC6_OFF		SC5_OFF	

Table 36. Bit Descriptions for the ISCT1 Register

Bit Name	Bit No.	Description <sup>1</sup>
SCON	[7:6]	SC on time. If the SCx_OFF time is not disabled and the independent current sink is enabled (Register 0x10), the LED(s) remains on for the on time selected (per the following list) and then turns off. 00 = 0.2 sec 01 = 0.6 sec 10 = 0.8 sec 11 = 1.2 sec
SC7_OFF	[5:4]	SC7 off time. When the SC off time is disabled, the ISC remains on while enabled. When the SC off time is set to any other value, then the ISC turns off for the off time (per the following listed times) and then turns on according to the SCON setting. 00 = off time disabled 01 = 0.6 sec 10 = 1.2 sec 11 = 1.8 sec
SC6_OFF	[3:2]	SC6 off time. When the SC off time is disabled, the ISC remains on while enabled. When the SC off time is set to any other value, then the ISC turns off for the off time (per the following listed times) and then turns on according to the SCON setting. 00 = off time disabled 01 = 0.6 sec 10 = 1.2 sec 11 = 1.8 sec
SC5_OFF	[1:0]	SC5 off time. When the SC off time is disabled, the ISC remains on while enabled. When the SC off time is set to any other value, then the ISC turns off for the off time (per the following listed times) and then turns on according to the SCON setting. 00 = off time disabled 01 = 0.6 sec 10 = 1.2 sec 11 = 1.8 sec

<sup>1</sup>Each current sink remains on continuously when its enable is set to 1 and its off time is set to 00 (disabled).



**Independent Sink Current Time (ISCT2)—Register 0x12**

Table 37. ISCT2 Bit Map

Bit 7	Bit 6	Bit 5	Bit 4	Bit 3	Bit 2	Bit 1	Bit 0
SC4_OFF		SC3_OFF		SC2_OFF		SC1_OFF	

Table 38. Bit Descriptions for the ISCT2 Register

Bit Name	Bit No.	Description <sup>1</sup>
SC4_OFF	[7:6]	SC4 off time. When the SC off time is disabled, the ISC remains on while enabled. When the SC off time is set to any other value, then the ISC turns off for the off time (per the following listed times) and then turns on according to the SCON setting. 00 = off time disabled 01 = 0.6 sec 10 = 1.2 sec 11 = 1.8 sec
SC3_OFF	[5:4]	SC3 off time. When the SC off time is disabled, the ISC remains on while enabled. When the SC off time is set to any other value, then the ISC turns off for the off time (per the following listed times) and then turns on according to the SCON setting. 00 = off time disabled 01 = 0.6 sec 10 = 1.2 sec 11 = 1.8 sec
SC2_OFF	[3:2]	SC2 off time. When the SC off time is disabled, the ISC remains on while enabled. When the SC off time is set to any other value, then the ISC turns off for the off time (per the following listed times) and then turns on according to the SCON setting. 00 = off time disabled 01 = 0.6 sec 10 = 1.2 sec 11 = 1.8 sec
SC1_OFF	[1:0]	SC1 off time. When the SC off time is disabled, the ISC remains on while enabled. When the SC off time is set to any other value, then the ISC turns off for the off time (per the following listed times) and then turns on according to the SCON setting. 00 = off time disabled 01 = 0.6 sec 10 = 1.2 sec 11 = 1.8 sec

<sup>1</sup> Each current sink remains on continuously when its enable is set to 1 and its off time is set to 00 (disabled).

**Independent Sink Current Fade (ISCF)—Register 0x13**

Table 39. ISCF Bit Map

Bit 7	Bit 6	Bit 5	Bit 4	Bit 3	Bit 2	Bit 1	Bit 0
SCFO				SCFI			

Table 40. Bit Descriptions for the ISCF Register

Bit Name	Bit No.	Description
SCFO	[7:4]	<p>Sink current fade out rate. The following times listed are for a full-scale fade out (30 mA to 0 mA). Fades between closer current values reduce the fade time. See the Automated Fade In and Fade Out section for more information.</p> <p>0000 = disabled            0001 = 0.30 sec            0010 = 0.60 sec            0011 = 0.90 sec            0100 = 1.2 sec            0101 = 1.5 sec            0110 = 1.8 sec            0111 = 2.1 sec            1000 = 2.4 sec            1001 = 2.7 sec            1010 = 3.0 sec            1011 = 3.5 sec            1100 = 4.0 sec            1101 = 4.5 sec            1110 = 5.0 sec            1111 = 5.5 sec</p>
SCFI	[3:0]	<p>Sink current fade in rate. The following times listed are for a full-scale fade in (0 mA to 30 mA). Fades between closer current values reduce the fade time. See the Automated Fade In and Fade Out section for more information.</p> <p>0000 = disabled            0001 = 0.30 sec            0010 = 0.60 sec            0011 = 0.90 sec            0100 = 1.2 sec            0101 = 1.5 sec            0110 = 1.8 sec            0111 = 2.1 sec            1000 = 2.4 sec            1001 = 2.7 sec            1010 = 3.0 sec            1011 = 3.5 sec            1100 = 4.0 sec            1101 = 4.5 sec            1110 = 5.0 sec            1111 = 5.5 sec</p>

**Sink Current Register LED7 (ISC7)—Register 0x14**

Table 41. ISC7 Bit Map

Bit 7	Bit 6	Bit 5	Bit 4	Bit 3	Bit 2	Bit 1	Bit 0
SCR	SCD7						

Table 42. Bit Descriptions for the ISC7 Register

Bit Name	Bit No.	Description
SCR	7	1 = Sink Current 1. 0 = Sink Current 0.
SCD7	[6:0]	For Sink Current 0, use the following DAC code schedule (see Table 28 for a complete list of values):
		<b>DAC</b> <b>Linear Law (mA)</b> <b>Square Law (mA)</b>
		0000000      0      0.000
		0000001      0.236      0.002
		0000010      0.472      0.007
		0000011      0.709      0.017
		...      ...      ...
		1111111      30      30
		For Sink Current 1, use the following DAC code schedule (see Table 43 for a complete list of values):
		<b>DAC</b> <b>Linear Law (mA)</b> <b>Square Law (mA)</b>
		0000000      0.000      0
		0000001      0.472      0.004
0000010      0.945      0.014		
0000011      1.417      0.034		
...      ...      ...		
1111111      60      60		

Table 43. Linear and Square Law Currents for LED7 (SCR = 1)

DAC Code	Linear Law (mA)	Square Law (mA) <sup>1</sup>	DAC Code	Linear Law (mA)	Square Law (mA) <sup>1</sup>
0x00	0.000	0	0x19	11.81	2.326
0x01	0.472	0.004	0x1A	12.28	2.514
0x02	0.945	0.014	0x1B	12.76	2.712
0x03	1.42	0.034	0x1C	13.23	2.916
0x04	1.89	0.06	0x1D	13.70	3.128
0x05	2.36	0.094	0x1E	14.17	3.348
0x06	2.83	0.134	0x1F	14.65	3.574
0x07	3.31	0.182	0x20	15.12	3.81
0x08	3.78	0.238	0x21	15.59	4.052
0x09	4.25	0.302	0x22	16.06	4.3
0x0A	4.72	0.372	0x23	16.54	4.558
0x0B	5.20	0.45	0x24	17.01	4.822
0x0C	5.67	0.536	0x25	17.48	5.092
0x0D	6.14	0.628	0x26	17.95	5.372
0x0E	6.61	0.73	0x27	18.43	5.658
0x0F	7.09	0.838	0x28	18.90	5.952
0x10	7.56	0.952	0x29	19.37	6.254
0x11	8.03	1.076	0x2A	19.84	6.562
0x12	8.50	1.206	0x2B	20.31	6.878
0x13	8.98	1.342	0x2C	20.79	7.202
0x14	9.45	1.488	0x2D	21.26	7.534
0x15	9.92	1.64	0x2E	21.73	7.872
0x16	10.39	1.8	0x2F	22.20	8.218
0x17	10.87	1.968	0x30	22.68	8.57
0x18	11.34	2.142	0x31	23.15	8.932

DAC Code	Linear Law (mA)	Square Law (mA) <sup>1</sup>	DAC Code	Linear Law (mA)	Square Law (mA) <sup>1</sup>
0x32	23.62	9.3	0x59	42.05	29.466
0x33	24.09	9.676	0x5A	42.52	30.132
0x34	24.57	10.058	0x5B	42.99	30.806
0x35	25.04	10.45	0x5C	43.46	31.486
0x36	25.51	10.848	0x5D	43.94	32.174
0x37	25.98	11.254	0x5E	44.41	32.87
0x38	26.46	11.666	0x5F	44.88	33.574
0x39	26.93	12.086	0x60	45.35	34.284
0x3A	27.40	12.514	0x61	45.83	35.002
0x3B	27.87	12.95	0x62	46.30	35.726
0x3C	28.35	13.392	0x63	46.77	36.46
0x3D	28.82	13.842	0x64	47.24	37.2
0x3E	29.29	14.3	0x65	47.72	37.948
0x3F	29.76	14.764	0x66	48.19	38.702
0x40	30.24	15.238	0x67	48.66	39.466
0x41	30.71	15.718	0x68	49.13	40.236
0x42	31.18	16.204	0x69	49.61	41.014
0x43	31.65	16.7	0x6A	50.08	41.798
0x44	32.13	17.202	0x6B	50.55	42.59
0x45	32.60	17.71	0x6C	51.02	43.39
0x46	33.07	18.228	0x6D	51.50	44.198
0x47	33.54	18.752	0x6E	51.97	45.012
0x48	34.02	19.284	0x6F	52.44	45.834
0x49	34.49	19.824	0x70	52.91	46.664
0x4A	34.96	20.37	0x71	53.39	47.5
0x4B	35.43	20.926	0x72	53.86	48.346
0x4C	35.91	21.486	0x73	54.33	49.198
0x4D	36.38	22.056	0x74	54.80	50.056
0x4E	36.85	22.632	0x75	55.28	50.924
0x4F	37.32	23.216	0x76	55.75	51.798
0x50	37.80	23.808	0x77	56.22	52.68
0x51	38.27	24.406	0x78	56.69	53.568
0x52	38.74	25.014	0x79	57.17	54.464
0x53	39.21	25.628	0x7A	57.64	55.368
0x54	39.69	26.248	0x7B	58.11	56.28
0x55	40.16	26.878	0x7C	58.58	57.198
0x56	40.63	27.514	0x7D	59.06	58.126
0x57	41.10	28.156	0x7E	59.53	59.058
0x58	41.57	28.808	0x7F	60	60

<sup>1</sup> Cubic 10 and Cubic 11 laws use the square law DAC setting but vary the time step per DAC code (see Figure 30).

**Sink Current Register LED6 (ISC6)—Register 0x15**

Table 44. ISC6 Bit Map

Bit 7	Bit 6	Bit 5	Bit 4	Bit 3	Bit 2	Bit 1	Bit 0
Reserved	SCD6						

Table 45. Bit Descriptions for the ISC6 Register

Bit Name	Bit No.	Description		
N/A	7	Reserved.		
SCD6	[6:0]	Sink current. Use the following DAC code schedule (see Table 28 for a complete list of values).		
		<b>DAC</b>	<b>Linear Law (mA)</b>	<b>Square Law (mA)</b>
		0000000	0	0.000
		0000001	0.236	0.002
		0000010	0.472	0.007
		0000011	0.709	0.017
		...	...	...
1111111	30	30		

**Sink Current Register LED5 (ISC5)—Register 0x16**

Table 46. ISC5 Bit Map

Bit 7	Bit 6	Bit 5	Bit 4	Bit 3	Bit 2	Bit 1	Bit 0
Reserved	SCD5						

Table 47. Bit Descriptions for the ISC5 Register

Bit Name	Bit No.	Description		
N/A	7	Reserved.		
SCD5	[6:0]	Sink current. Use the following DAC code schedule (see Table 28 for a complete list of values):		
		<b>DAC</b>	<b>Linear Law (mA)</b>	<b>Square Law (mA)</b>
		0000000	0	0.000
		0000001	0.236	0.002
		0000010	0.472	0.007
		0000011	0.709	0.017
		...	...	...
1111111	30	30		

**Sink Current Register LED4 (ISC4)—Register 0x17**

Table 48. ISC4 Bit Map

Bit 7	Bit 6	Bit 5	Bit 4	Bit 3	Bit 2	Bit 1	Bit 0
Reserved	SCD4						

Table 49. Bit Descriptions for the ISC4 Register

Bit Name	Bit No.	Description		
N/A	7	Reserved.		
SCD4	[6:0]	Sink current. Use the following DAC code schedule (see Table 28 for a complete list of values):		
		<b>DAC</b>	<b>Linear Law (mA)</b>	<b>Square Law (mA)</b>
		0000000	0	0
		0000001	0.236	0.002
		0000010	0.472	0.007
		0000011	0.709	0.017
		...	...	...
1111111	30	30		

**Sink Current Register LED3 (ISC3)—Register 0x18**

Table 50. ISC3 Bit Map

Bit 7	Bit 6	Bit 5	Bit 4	Bit 3	Bit 2	Bit 1	Bit 0
Reserved	SCD3						

Table 51. Bit Descriptions for the ISC3 Register

Bit Name	Bit No.	Description		
N/A	7	Reserved.		
SCD3	[6:0]	Sink current. Use the following DAC code schedule (see Table 28 for a complete list of values):		
		<b>DAC</b>	<b>Linear Law (mA)</b>	<b>Square Law (mA)</b>
		0000000	0	0.000
		0000001	0.236	0.002
		0000010	0.472	0.007
		0000011	0.709	0.017
...	...	...		
1111111	30	30		

**Sink Current Register LED2 (ISC2)—Register 0x19**

Table 52. ISC2 Bit Map

Bit 7	Bit 6	Bit 5	Bit 4	Bit 3	Bit 2	Bit 1	Bit 0
Reserved	SCD2						

Table 53. Bit Descriptions for the ISC2 Register

Bit Name	Bit No.	Description		
N/A	7	Reserved.		
SCD2	[6:0]	Sink current. Use the following DAC code schedule (see Table 28 for a complete list of values):		
		<b>DAC</b>	<b>Linear Law (mA)</b>	<b>Square Law (mA)</b>
		0000000	0	0.000
		0000001	0.236	0.002
		0000010	0.472	0.007
		0000011	0.709	0.017
...	...	...		
1111111	30	30		

**Sink Current Register LED1 (ISC1)—Register 0x1A**

Table 54. ISC1 Bit Map

Bit 7	Bit 6	Bit 5	Bit 4	Bit 3	Bit 2	Bit 1	Bit 0
Reserved	SCD1						

Table 55. Bit Descriptions for the ISC1 Register

Bit Name	Bit No.	Description		
N/A	7	Reserved.		
SCD1	[6:0]	Sink current. Use the following DAC code schedule (see Table 28 for a complete list of values):		
		<b>DAC</b>	<b>Linear Law (mA)</b>	<b>Square Law (mA)</b>
		0000000	0	0.000
		0000001	0.236	0.002
		0000010	0.472	0.007
		0000011	0.709	0.017
...	...	...		
1111111	30	30		

# OUTLINE DIMENSIONS

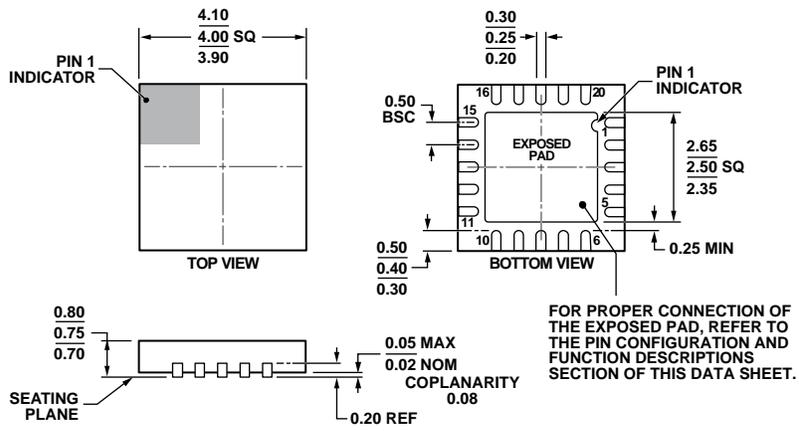

COMPLIANT TO JEDEC STANDARDS MO-220-WGGD.  
 Figure 44. 20-Lead Lead Frame Chip Scale Package [LFCSF\_WQ]  
 4 mm x 4 mm Body, Very Thin Quad  
 (CP-20-10)  
 Dimensions shown in millimeters

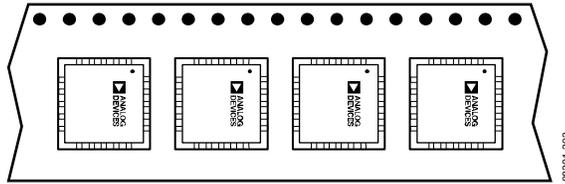

Figure 45. Tape and Reel Orientation for LFCSF Units

061608-B

08391-203

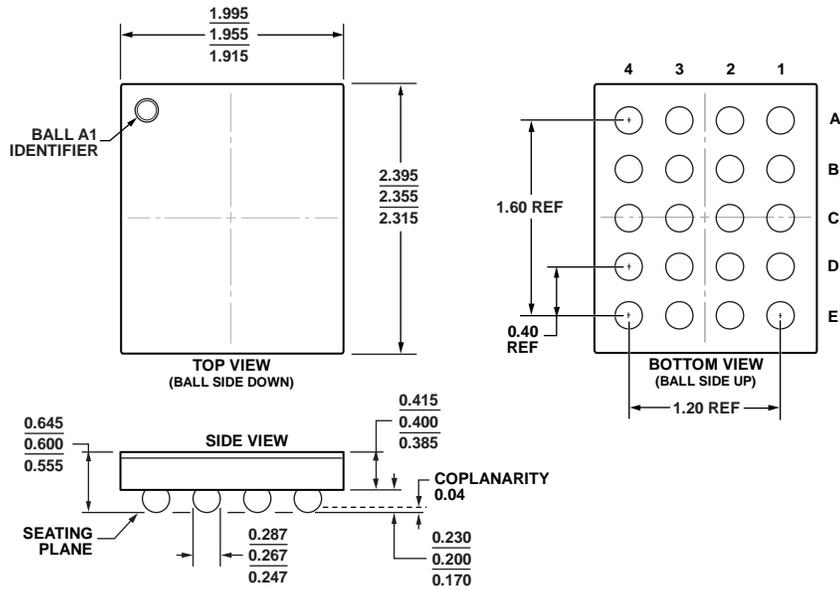

Figure 46. 20-Ball Wafer Level Chip Scale Package [WLCSP] (CB-20-6)  
Dimensions shown in millimeters

04-24-2012-A

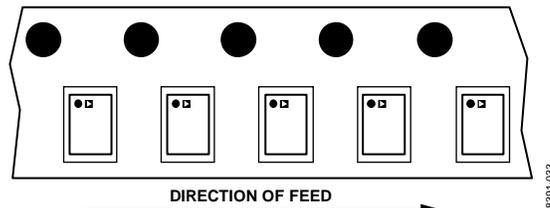

Figure 47. Tape and Reel Orientation for WLCSP Units

**ORDERING GUIDE**

Model <sup>1</sup>	Temperature Range	Package Description	Package Option
ADP8861ACPZ-RL	-40°C to +85°C	20-Lead LFCSP_WQ, 13" Tape and Reel	CP-20-10
ADP8861ACBZ-R7	-40°C to +85°C	20-Ball WLCSP, 7" Tape and Reel	CB-20-6
ADP8861DBCB-EVALZ		Daughter Card	
ADP886XMB1-EVALZ		USB-to-I <sup>2</sup> C Adapter Board	

<sup>1</sup> Z = RoHS Compliant Part.

I<sup>2</sup>C refers to a communications protocol originally developed by Philips Semiconductors (now NXP Semiconductors).





## Стандарт Электрон Связь

Мы молодая и активно развивающаяся компания в области поставок электронных компонентов. Мы поставляем электронные компоненты отечественного и импортного производства напрямую от производителей и с крупнейших складов мира.

Благодаря сотрудничеству с мировыми поставщиками мы осуществляем комплексные и плановые поставки широчайшего спектра электронных компонентов.

Собственная эффективная логистика и склад в обеспечивает надежную поставку продукции в точно указанные сроки по всей России.

Мы осуществляем техническую поддержку нашим клиентам и предпродажную проверку качества продукции. На все поставляемые продукты мы предоставляем гарантию .

Осуществляем поставки продукции под контролем ВП МО РФ на предприятия военно-промышленного комплекса России , а также работаем в рамках 275 ФЗ с открытием отдельных счетов в уполномоченном банке. Система менеджмента качества компании соответствует требованиям ГОСТ ISO 9001.

Минимальные сроки поставки, гибкие цены, неограниченный ассортимент и индивидуальный подход к клиентам являются основой для выстраивания долгосрочного и эффективного сотрудничества с предприятиями радиоэлектронной промышленности, предприятиями ВПК и научно-исследовательскими институтами России.

С нами вы становитесь еще успешнее!

### Наши контакты:

**Телефон:** +7 812 627 14 35

**Электронная почта:** [sales@st-electron.ru](mailto:sales@st-electron.ru)

**Адрес:** 198099, Санкт-Петербург,  
Промышленная ул, дом № 19, литера Н,  
помещение 100-Н Офис 331