

AVR-P40-8535 development board

Users Manual



All boards produced by Olimex are ROHS compliant

Revision A, October 2009

Copyright(c) 2009, OLIMEX Ltd, All rights reserved

INTRODUCTION

The **AVR Microcontroller** are low-power CMOS 8-bit controller based on the RISC architecture. The AVR core combines a rich instruction set with general purpose working registers. All the registers are directly connected to the Arithmetic Logic Unit (ALU), allowing two independent registers to be accessed in one single instruction executed in one clock cycle. The resulting architecture is more code efficient while achieving throughputs up to ten times faster than conventional CISC microcontrollers.

The **AVR-P40-8535** is prototype board for 40 pin AVR microcontrollers with STKxxx compatible 10 pin ICSP connector.

BOARD FEATURES

- STK200 compatible ICSP 5x2 pin connector for in-circuit programming with AVR-PG1 or AVR-PG2
- JTAG 5x2 pin connectr for in-circuit programming and debugging with AVR-JTAG-USB and AVR-JTAG-L
- RS232 Tx, Rx interface with MAX232 IC on socket
- 8 MHz crystal on socket (user can replace with any value)
- reset IC ZM33064
- reset button
- general purpose push button
- status LED connected to PB0 via removable jumper
- DIL40 microcontroller socket
- Power plug-in jack
- selectable +3.3V / +5V power supply voltage regulator
- extension pin headers for each uC pin
- four mounting holes 3.3 mm (0.13")
- GND bus
- Vcc bus
- FR-4, 1.5 mm (0,062"), green soldermask, white silkscreen component print
- dimensions 100x80 mm (3.9x3.15")

ELECTROSTATIC WARNING

The AVR-P40-8535 board is shipped in protective anti-static packaging. The board must not be subject to high electrostatic potentials. General practice for working with static sensitive devices should be applied when working with this board.

BOARD USE REQUIREMENTS

Cables: The cable you will need depends on the programmer/debugger you use. If you use [AVR-PG1](#), or [AVR-JTAG-L](#), you will need RS232 cable, if you use [AVR-PG2](#), you will need LPT cable, if you use [AVR-ISP500](#), [AVR-ISP500-TINY](#), [AVR-ISP500-ISO](#), or [AVR-USB-JTAG](#) you will need 1.8 meter USB A-B cable.

Hardware: Programmer/Debugger – one of the Olimex AVR Programmers: AVR-PG1, AVR-PG2, AVR-ISP500, AVR-ISP500-TINY, AVR-ISP500-ISO, AVR-JTAG-L, AVR-USB-JTAG.

SCHEMATIC

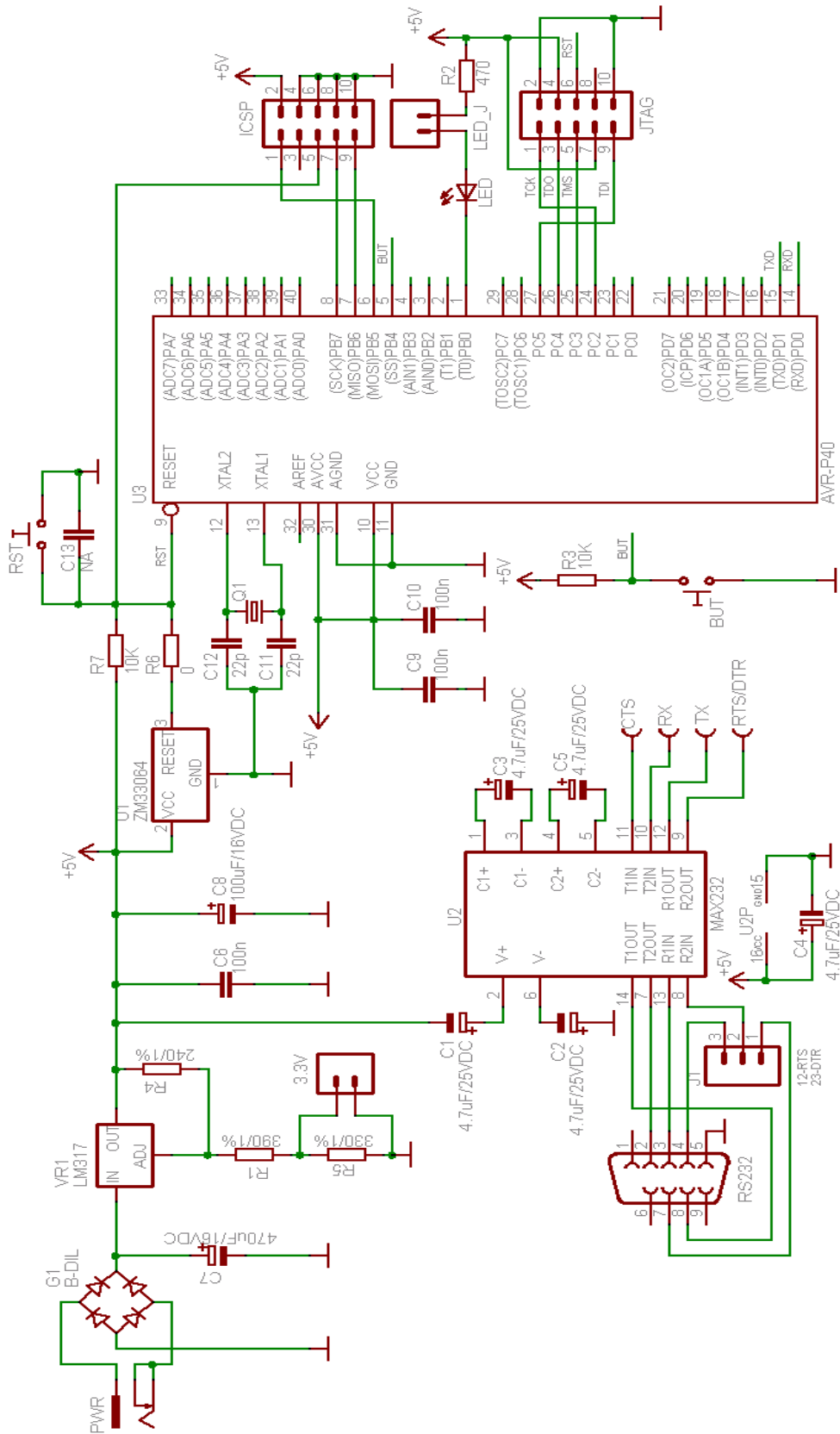

Copyright (C) 2002, OLIMEX Ltd
<http://www.olimex.com/dev>

BOARD LAYOUT

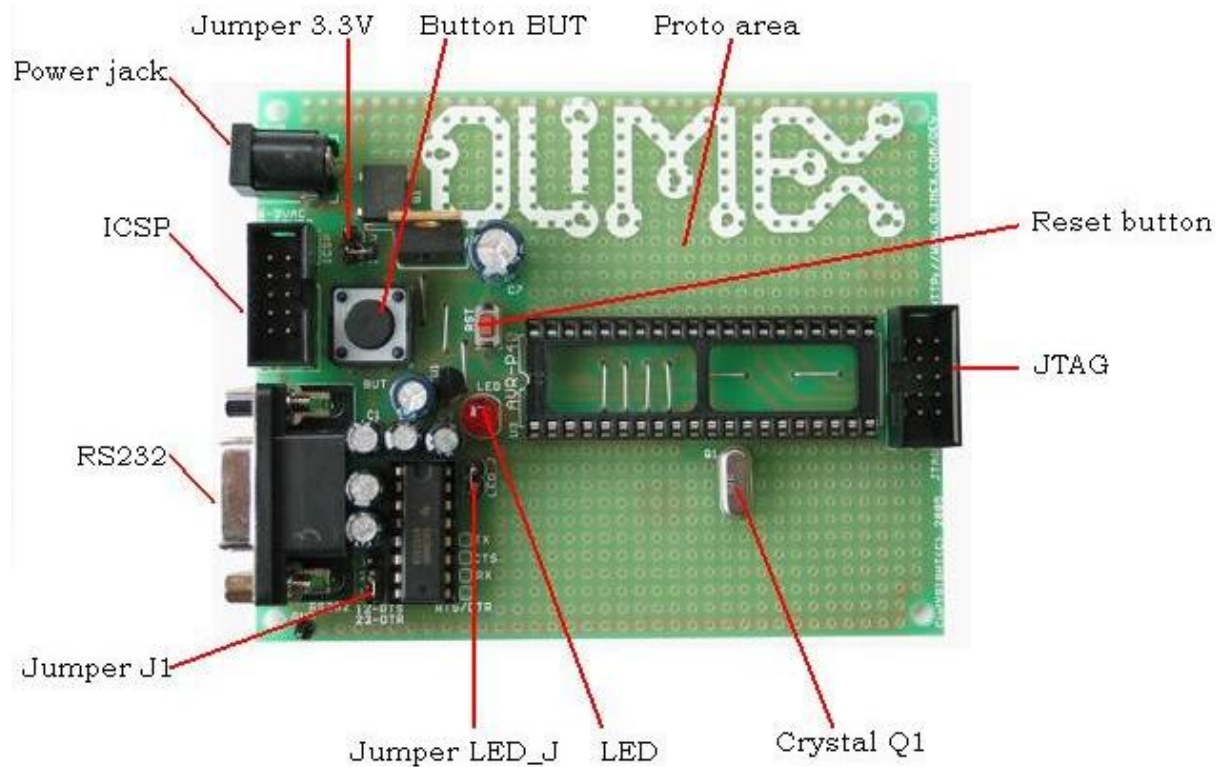

POWER SUPPLY CIRCUIT

AVR-P40-8535 is typically power supplied with min 9.0V DC max 12.0V DC, or min 6.0V AC max 9.0V AC.

RESET CIRCUIT

AVR-P40-8535 reset circuit includes pin 5 of ICSP connector, pin 6 of JTAG connector, pin 9 of U3, Reset scheme - U1 and RESET button (RST).

CLOCK CIRCUIT

Quartz crystal 8MHz is connected to AVR Microcontroller pin 12 (XTAL2) and pin 13 (XTAL1).

JUMPER DESCRIPTION

J1

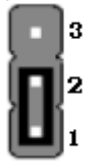

When 1-2 are shorted – RTS is connected to terminal pin RTS/DTR.
 When 2-3 are shorted – DTR is connected to terminal pin RTS/DTR.
Default state is 1-2.

LED_J



When this jumper is open – LED is not connected.
 When this jumper is closed – LED is connected to pin1 (T0/PB0) of the Microcontroller.
Default state is closed.

3.3V



When this jumper is open – LM317 output is 5V DC.
 When this jumper is closed – LM317 output is 3.3V DC.
Default state is open.

WARNINGS!!!

1. The 3.3V jumper selects the power voltage to be 5V (open) or 3.3V (closed). MAX232 can operate only at 5V power supply so if you are working with 3.3V you should replace it with MAX3232 which works at 3.3V power supply.

2. If you want to operate with 3,3V power supply, remove R6 resistor.

INPUT/OUTPUT

Status Led with name **LED (red)** – this led is connected to PIN1 (T0 / PB0) via jumper LED_J.

User button with name **BUT** - connected to PIN5 (SS / PB4).

Reset button with name **RST** - connected to PIN9 (RESET).

CONNECTOR DESCRIPTIONS

ICSP

PIN #	Signal Name	Functionality
1	MOSI	MOSI / PB5
2	VCC	+5V DC
3	Not connected	-
4	GND	Ground
5	RST	RESET
6	GND	Ground
7	SCK	SCK / PB7
8	GND	Ground
9	MISO	MISO / PB6
10	GND	Ground

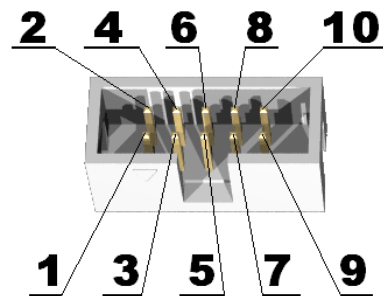

JTAG

PIN #	Signal Name	Functionality
1	TCK	PC2
2	GND	Ground
3	TDO	PC4
4	VREF	+5V DC
5	TMS	PC3
6	NSRST	Reset
7	VCC	+5V DC
8	NTRST	Not connected
9	TDI	PC5
10	GND	Ground

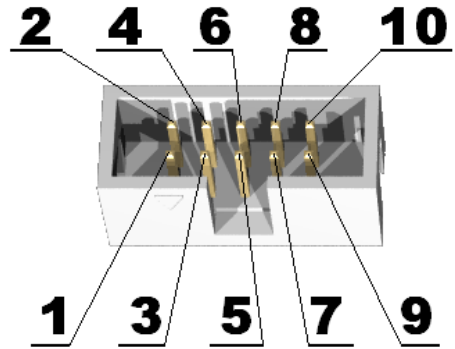

RS232

PIN #	Signal Name
1	CD - Not connected
2	RXD
3	TXD
4	DTR
5	GND
6	DSR - Not connected
7	RTS
8	CTS
9	RI - Not connected

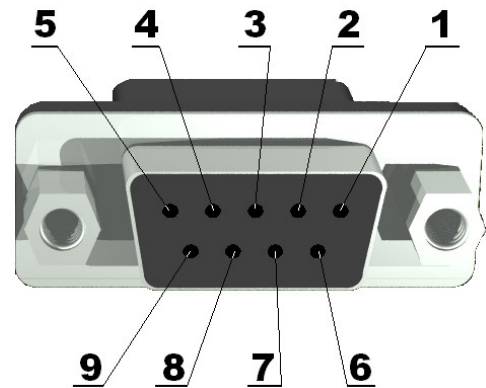

Note1: RTS and DTR is connected to terminal pins via jumper J1, which position is describe bellow.

Note2: RX RS232 driver pins have to be connected to AVR microcontroller pin - TXD/PD1 (PIN 15).
TX RS232 driver pins have to be connected to AVR microcontroller pin - RXD/PD0 (PIN 14).

PWR

PIN #	Signal Name
1	Power Input
2	GND

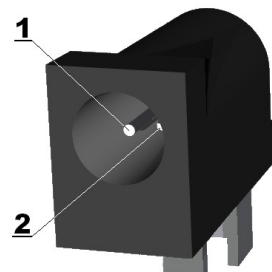

AVAILABLE DEMO SOFTWARE

- AVR-P40-8535 + ATmega16 blink LED ([C source](#) and [HEX](#))
- AVR-P40-8535 + ATmega16 UART demo code ([C source](#) and [HEX](#))
- AVR-P40-8535 + ATmega16 Button demo code ([C source](#) and [HEX](#))
- AVR-P40-8535 + ATmega16 UART menu demo code ([C source](#) and [HEX](#))

ORDER CODE

AVR-P40-8535-8MHz completely assembled and tested with 8Mhz oscillator
AVR-P40-8535/PCB ONLY

How to order?

You can order to us directly or by any of our distributors.

Check our web www.olimex.com/dev for more info.

Revision history

REV.A - created October 2009

Disclaimer

© 2009 Olimex Ltd. All rights reserved. Olimex®, logo and combinations thereof, are registered trademarks of Olimex Ltd. Other terms and product names may be trademarks of others.

The information in this document is provided in connection with Olimex products. No license, express or implied or otherwise, to any intellectual property right is granted by this document or in connection with the sale of Olimex products.

Neither the whole nor any part of the information contained in or the product described in this document may be adapted or reproduced in any material form except with the prior written permission of the copyright holder.

The product described in this document is subject to continuous development and improvements. All particulars of the product and its use contained in this document are given by OLIMEX in good faith. However all warranties implied or expressed including but not limited to implied warranties of merchantability or fitness for purpose are excluded.

This document is intended only to assist the reader in the use of the product. OLIMEX Ltd. shall not be liable for any loss or damage arising from the use of any information in this document or any error or omission in such information or any incorrect use of the product.



Стандарт Электрон Связь

Мы молодая и активно развивающаяся компания в области поставок электронных компонентов. Мы поставляем электронные компоненты отечественного и импортного производства напрямую от производителей и с крупнейших складов мира.

Благодаря сотрудничеству с мировыми поставщиками мы осуществляем комплексные и плановые поставки широчайшего спектра электронных компонентов.

Собственная эффективная логистика и склад в обеспечивает надежную поставку продукции в точно указанные сроки по всей России.

Мы осуществляем техническую поддержку нашим клиентам и предпродажную проверку качества продукции. На все поставляемые продукты мы предоставляем гарантию .

Осуществляем поставки продукции под контролем ВП МО РФ на предприятия военно-промышленного комплекса России , а также работаем в рамках 275 ФЗ с открытием отдельных счетов в уполномоченном банке. Система менеджмента качества компании соответствует требованиям ГОСТ ISO 9001.

Минимальные сроки поставки, гибкие цены, неограниченный ассортимент и индивидуальный подход к клиентам являются основой для выстраивания долгосрочного и эффективного сотрудничества с предприятиями радиоэлектронной промышленности, предприятиями ВПК и научно-исследовательскими институтами России.

С нами вы становитесь еще успешнее!

Наши контакты:

Телефон: +7 812 627 14 35

Электронная почта: sales@st-electron.ru

Адрес: 198099, Санкт-Петербург,
Промышленная ул, дом № 19, литера Н,
помещение 100-Н Офис 331