

 **Insulated Gate Bipolar Transistor**

**Features**

- ▶ Low voltage drop at high currents
- ▶ Industry standard TO-252 (D-Pak) package
- ▶ 700V breakdown voltage rating

**Applications**

- ▶ White goods
- ▶ Small appliances
- ▶ Lighting controls
- ▶ Motor drives
- ▶ Meter readers
- ▶ Small off-line power supplies

**General Description**

The Supertex GN2470 is a 700V, 3.5amp insulated gate bipolar transistor (IGBT) that combines the positive aspects of both BJTs and MOSFETs.

The GN2470 IGBT has lower on-state voltage drop with high blocking voltage capabilities and features many desirable properties including a MOS input gate, low conduction voltage drop at high currents.

**Ordering Information**

Device	Package Option
	TO-252 (D-PAK)
GN2470	GN2470K4-G

-G indicates that the package is RoHS certified ("Green")



**Pin Configuration**

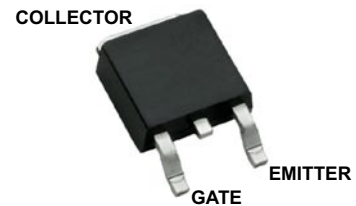

TO-252 (D-PAK) (K4)

**Pin Configuration**

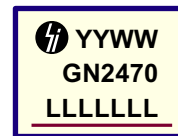

YY = Year Sealed  
 WW = Week Sealed  
 L = Lot Number  
 \_\_\_\_\_ = "Green" Packaging

TO-252 (D-PAK) (K4)

**Absolute Maximum Ratings**

Parameter	Value
Collector-to-emitter voltage	700V
Gate-to-emitter voltage	±20V
Operating junction and storage temperature range	-55°C to +150°C
Soldering temperature*	300°C

Absolute Maximum Ratings are those values beyond which damage to the device may occur. Functional operation under these conditions is not implied. Continuous operation of the device at the absolute rating level may affect device reliability. All voltages are referenced to device ground.

\* Distance of 1.6mm from case for 10 seconds.

## Thermal Characteristics

Package	$I_C$ (continuous)	$I_C$ (pulsed)	Power Dissipation @ $T_A = 25^\circ\text{C}$	$\theta_{jc}$ ( $^\circ\text{C}/\text{W}$ )	$\theta_{ja}$ ( $^\circ\text{C}/\text{W}$ )
TO-252	1.0A	3.5A	2.5W	10	60†

**Notes:**

† Mounted on FR4 board, 25mm x 25mm x 1.57mm

## Electrical Characteristics ( $T_A = 25^\circ\text{C}$ unless otherwise specified)

Sym	Parameter	Min	Typ	Max	Units	Conditions
$BV_{CES}$	Collector-to-emitter breakdown voltage	700	-	-	V	$V_{GE} = 0\text{V}, I_C = 250\mu\text{A}$
$BV_{ECS}$	Emitter-to-collector breakdown voltage	-6.0	-10	-	V	$V_{GE} = 0\text{V}, I_C = 1.0\text{mA}$
$V_{GE(th)}$	Gate threshold voltage	1.5	-	3.5	V	$V_{CE} = V_{GE}, I_C = 1.0\text{mA}$
$V_{CE}$	Collector-to-emitter voltage drop	-	4.5	5.0	V	$I_C = 3.0\text{A}, V_{GE} = 13\text{V}$
$g_{fe}$	Forward transconductance	0.5	0.8	-	mho	$V_{CE} = 25\text{V}, I_C = 2.0\text{A}$
$I_{CES}$	Zero gate voltage collector current	-	-	100	$\mu\text{A}$	$V_{GE} = 0\text{V}, V_{CE} = 600\text{V}$
$I_{GES}$	Gate-to-emitter leakage current	-	-	$\pm 100$	nA	$V_{GE} = \pm 20\text{V}, V_{CE} = 0\text{V}$
$I_{C(ON)}$	On-state collector current	3.0	4.0	-	A	$V_{GE} = 10\text{V}, V_{CE} = 25\text{V}$
$t_{d(ON)}$	Turn-on delay time	-	8.0	15	ns	$V_{CC} = 25\text{V}$ $R_{GEN} = 25\Omega$ $R_L = 11\Omega$
$t_r$	Rise time	-	400	600		
$t_{d(OFF)}$	Turn-off delay time	-	20	50		
$t_f$	Fall time	-	7000	12000		
$C_{ISS}$	Input capacitance	-	100	150	pF	$V_{CE} = 25\text{V}$ $V_{GE} = 0\text{V}$ $f = 1\text{MHz}$
$C_{OSS}$	Output capacitance	-	12	25		
$C_{RSS}$	Reverse transfer capacitance	-	2	5		

**Notes:**

1. All D.C. parameters 100% tested at  $25^\circ\text{C}$  unless otherwise stated. (Pulse test: 300 $\mu\text{s}$  pulse, 2% duty cycle.)
2. All A.C. parameters sample tested.

## Switching Waveforms and Test Circuit

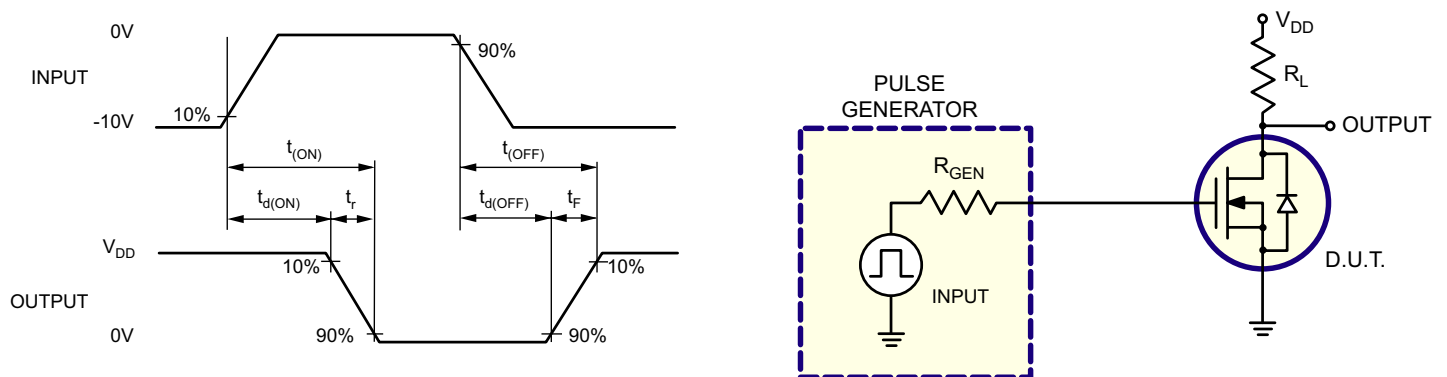

Typical Performance Waveform

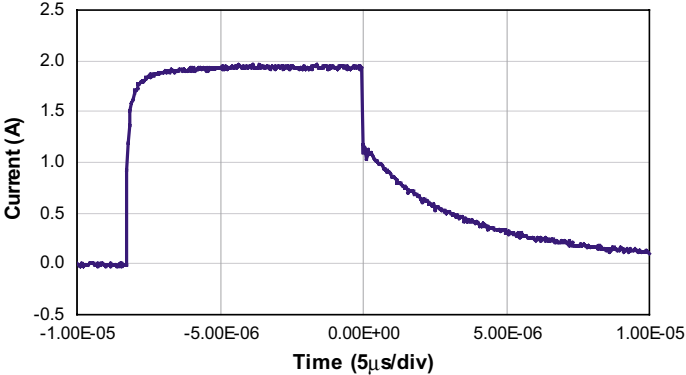

Equivalent Circuit

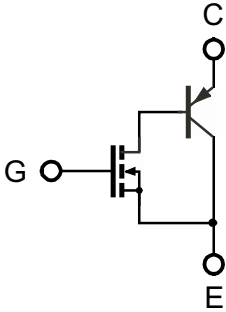

Saturation Characteristics

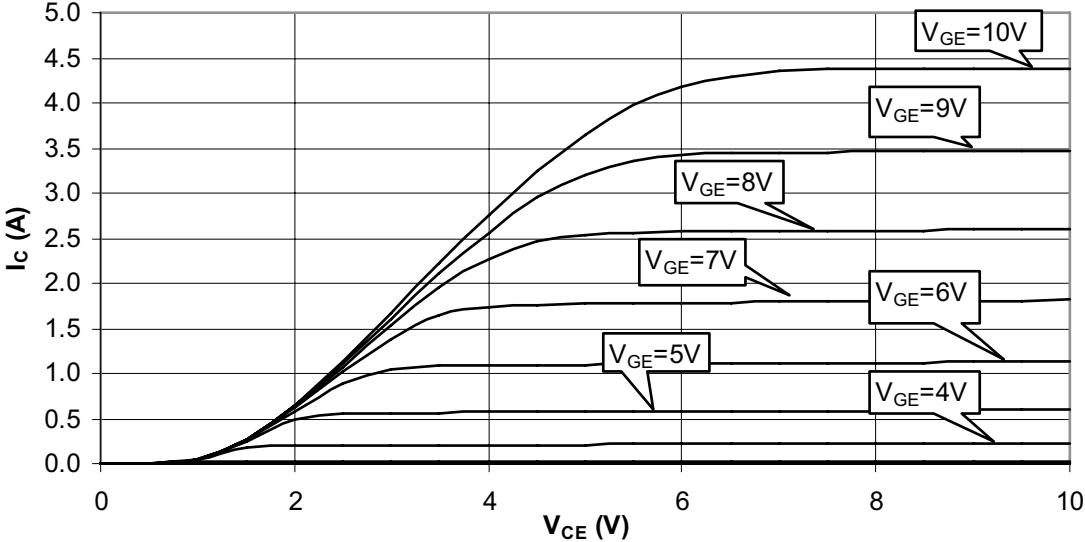

Transfer Characteristics

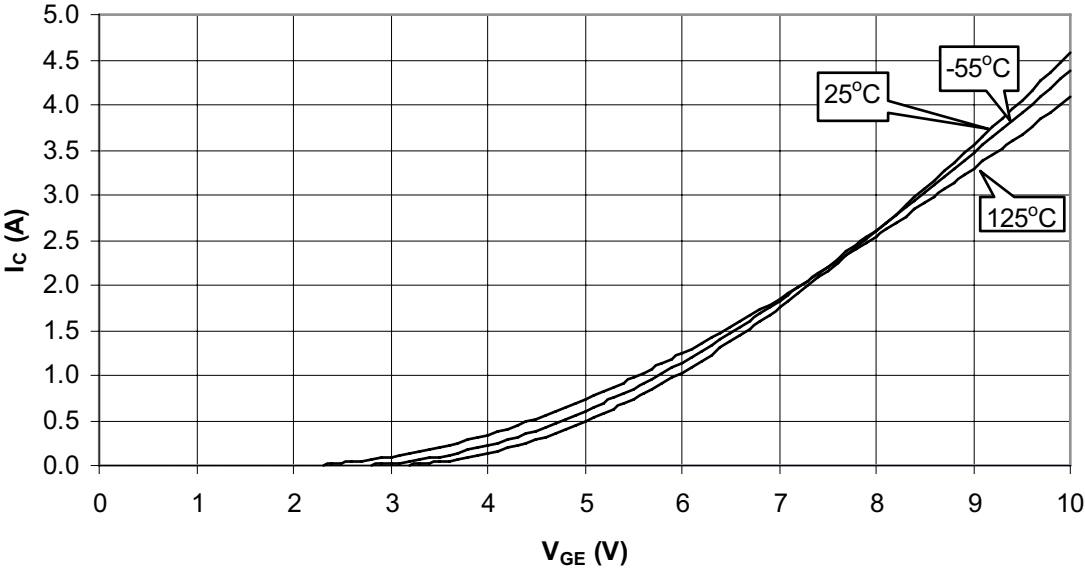

**$V_{GE(th)}$  Variation with Temperature**

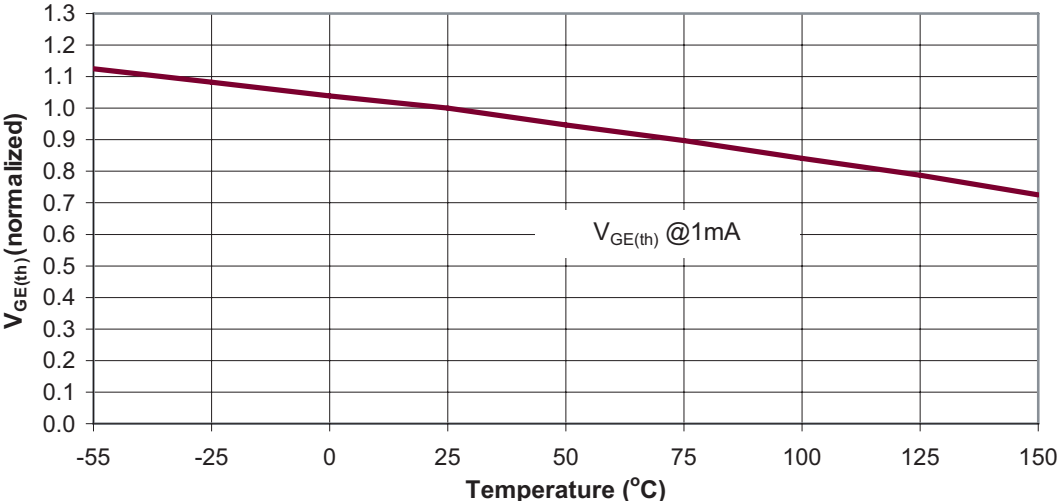

**$BV_{CES}$  Variation with Temperature**

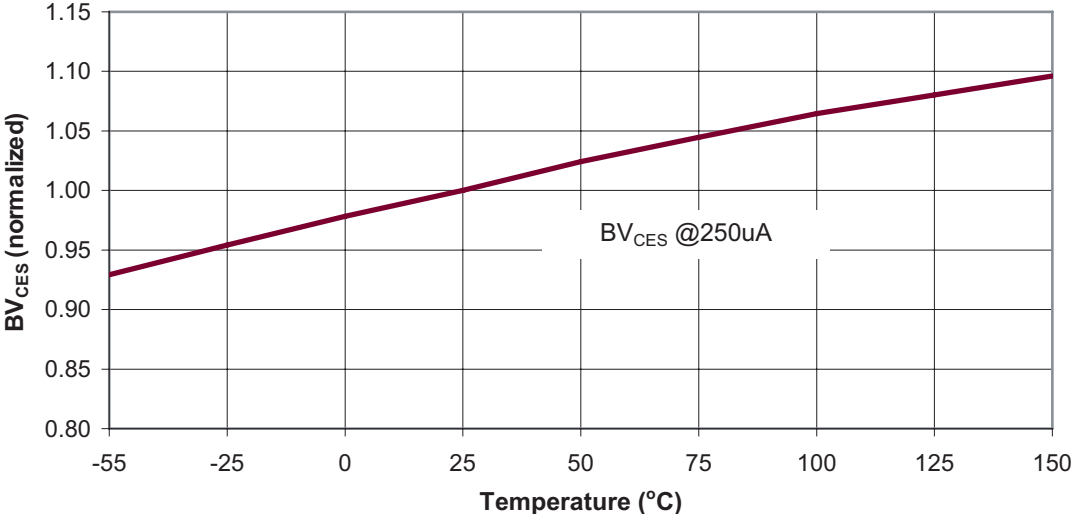

**Transconductance vs. Collector Current**

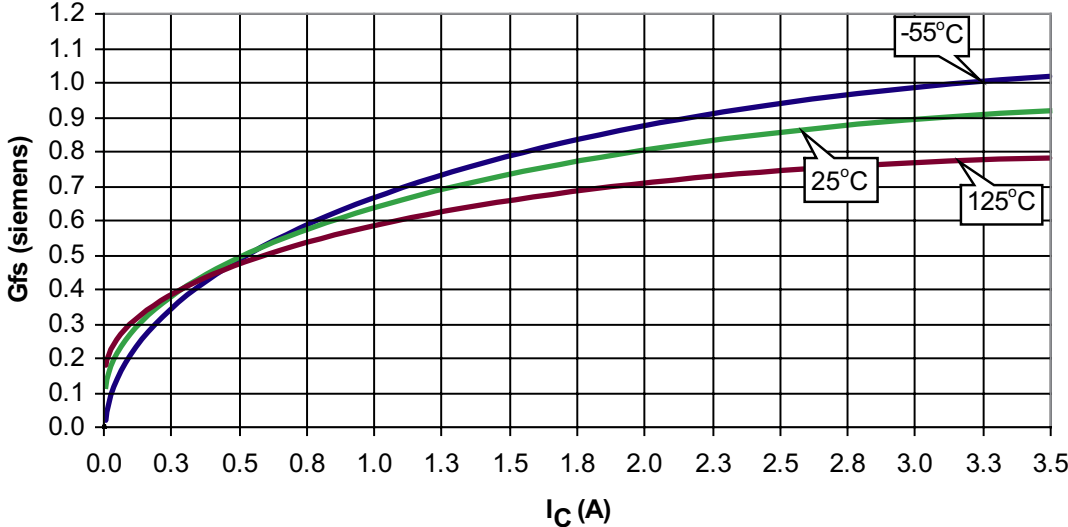

### 3-Lead TO-252 D-PAK Package Outline (K4)

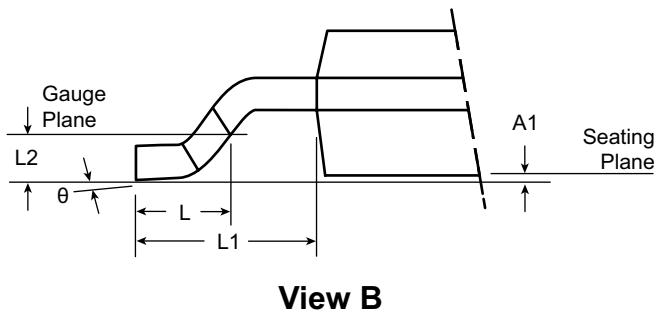
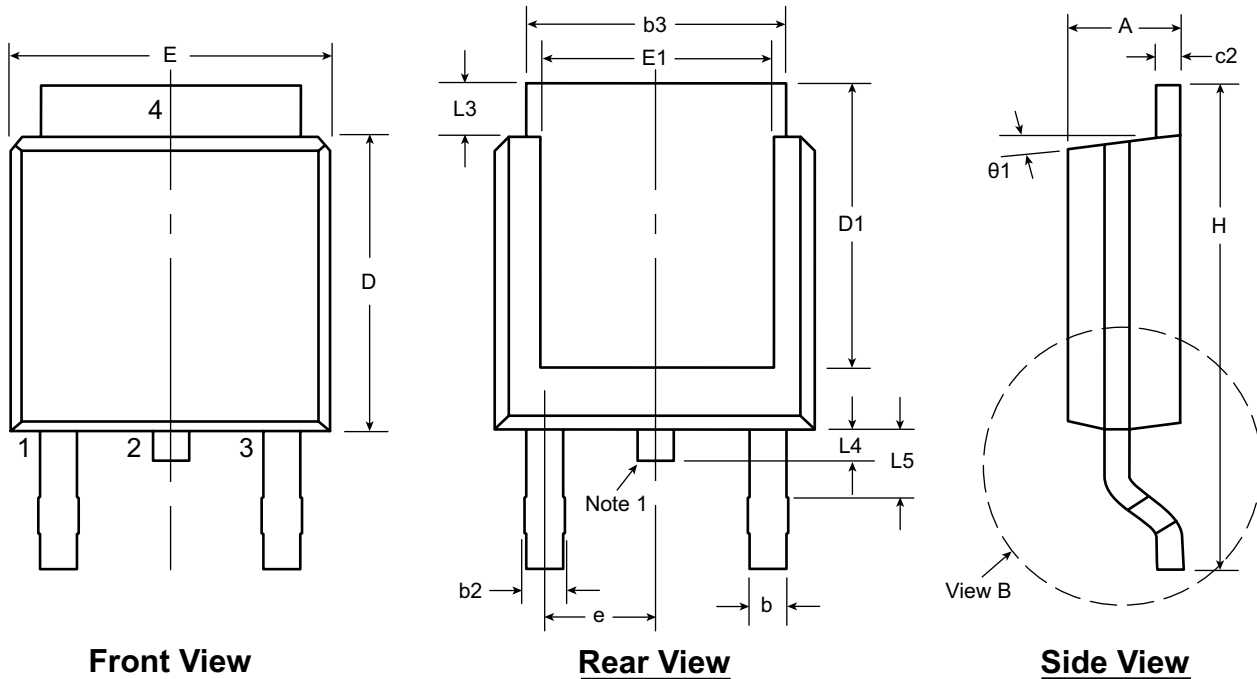

**Note:**  
 1. Although 4 terminal locations are shown, only 3 are functional. Lead number 2 was removed.

Symbol	A	A1	b	b2	b3	c2	D	D1	E	E1	e	H	L	L1	L2	L3	L4	L5	$\theta$	$\theta1$		
Dimension (inches)	MIN	.086	.000*	.025	.030	.195	.235	.205	.250	.170	.090 BSC	.370	.055	.108 REF	.020 BSC	.035	.025*	.045	0°	0°		
	NOM	-	-	-	-	-	.240	-	-	-		-	.060			-	-	-	-	-	-	-
	MAX	.094	.005	.035	.045	.215	.035	.245	.217*	.265		.182*	.410			.070	-	-	.050	.040	.060	10°

JEDEC Registration TO-252, Variation AA, Issue E, June 2004.  
 \* This dimension is not specified in the original JEDEC drawing. The value listed is for reference only.  
**Drawings not to scale.**  
**Supertex Doc. #: DSPD-3TO252K4, Version D081408.**

(The package drawing(s) in this data sheet may not reflect the most current specifications. For the latest package outline information go to <http://www.supertex.com/packaging.html>.)

Supertex inc. does not recommend the use of its products in life support applications, and will not knowingly sell them for use in such applications unless it receives an adequate "product liability indemnification insurance agreement." Supertex inc. does not assume responsibility for use of devices described, and limits its liability to the replacement of the devices determined defective due to workmanship. No responsibility is assumed for possible omissions and inaccuracies. Circuitry and specifications are subject to change without notice. For the latest product specifications refer to the Supertex inc. website: <http://www.supertex.com>.



## Стандарт Электрон Связь

Мы молодая и активно развивающаяся компания в области поставок электронных компонентов. Мы поставляем электронные компоненты отечественного и импортного производства напрямую от производителей и с крупнейших складов мира.

Благодаря сотрудничеству с мировыми поставщиками мы осуществляем комплексные и плановые поставки широчайшего спектра электронных компонентов.

Собственная эффективная логистика и склад в обеспечивает надежную поставку продукции в точно указанные сроки по всей России.

Мы осуществляем техническую поддержку нашим клиентам и предпродажную проверку качества продукции. На все поставляемые продукты мы предоставляем гарантию .

Осуществляем поставки продукции под контролем ВП МО РФ на предприятия военно-промышленного комплекса России , а также работаем в рамках 275 ФЗ с открытием отдельных счетов в уполномоченном банке. Система менеджмента качества компании соответствует требованиям ГОСТ ISO 9001.

Минимальные сроки поставки, гибкие цены, неограниченный ассортимент и индивидуальный подход к клиентам являются основой для выстраивания долгосрочного и эффективного сотрудничества с предприятиями радиоэлектронной промышленности, предприятиями ВПК и научно-исследовательскими институтами России.

С нами вы становитесь еще успешнее!

### Наши контакты:

**Телефон:** +7 812 627 14 35

**Электронная почта:** [sales@st-electron.ru](mailto:sales@st-electron.ru)

**Адрес:** 198099, Санкт-Петербург,  
Промышленная ул, дом № 19, литера Н,  
помещение 100-Н Офис 331