

Features

- One-input to nine-output buffer/driver
- Supports two DIMMs or four SO-DIMMs with one additional output for feedback to an external or chipset PLL
- Low power consumption for mobile applications
 - Less than 32 mA at 66.6 MHz with unloaded outputs
- 1-ns Input-Output delay
- Buffers all frequencies from DC to 133.33 MHz
- Output-output skew less than 250 ps
- Multiple V_{DD} and V_{SS} pins for noise and electromagnetic interference (EMI) reduction
- Space-saving 16-pin 150-mil SOIC package
- 3.3V operation
- Industrial temperature available

Functional Description

The CY2309NZ is a low-cost buffer designed to distribute high-speed clocks in mobile PC systems and desktop PC systems with SDRAM support. The part has nine outputs, eight of which can be used to drive two DIMMs or four SO-DIMMs, and the remaining can be used for external feedback to a PLL. The device operates at 3.3V and outputs can run up to 133.33 MHz.

The CY2309NZ is designed for low EMI and power optimization. It has multiple V_{SS} and V_{DD} pins for noise optimization and consumes less than 32 mA at 66.6 MHz, making it ideal for the low-power requirements of mobile systems. It is available in an ultra-compact 150-mil 16-pin SOIC package.

Logic Block Diagram

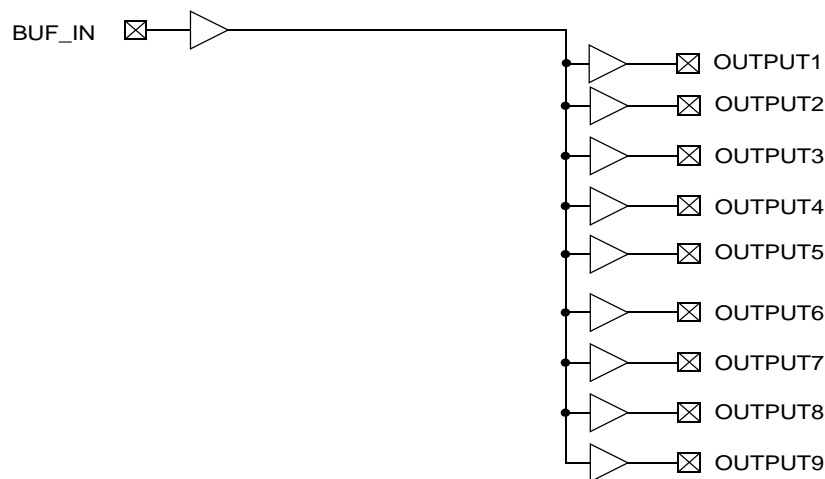

Pinouts

Figure 1. CY2309NZ - 16 SOIC-Top View

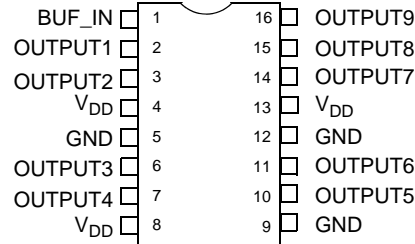

Table 1. Pin Description for CY2309NZ

Pin	Signal	Description
4, 8, 13	V _{DD}	3.3V Digital Voltage Supply
5, 9, 12	GND	Ground
1	BUF_IN	Input Clock
2, 3, 6, 7, 10, 11, 14, 15, 16	OUTPUT [1:9]	Outputs

Maximum Ratings

Supply Voltage to Ground Potential.....	-0.5V to +7.0V	Storage Temperature	-65°C to +150°C
DC Input Voltage (Except REF)	-0.5V to V _{DD} + 0.5V	Junction Temperature	150°C
DC Input Voltage REF	-0.5V to 7V	Static Discharge Voltage (per MIL-STD-883, Method 3015)	>2,000V

Operating Conditions for Commercial and Industrial Temperature Devices

Parameter	Description	Min	Max	Unit
V _{DD}	Supply Voltage	3.0	3.6	V
T _A	(Ambient Operating Temperature) Commercial	0	70	°C
	(Ambient Operating Temperature) Industrial	-40	85	°C
C _L	Load Capacitance, Fout < 100 MHz		30	pF
	Load Capacitance, 100 MHz < Fout < 133.33 MHz		15	pF
C _{IN}	Input Capacitance		7	pF
BUF_IN, OUTPUT [1:9]	Operating Frequency	DC	133.33	MHz
t _{PU}	Power up time for all VDDs to reach minimum specified voltage (power ramps must be monotonic)	0.05	50	ms

Electrical Characteristics for Commercial and Industrial Temperature Devices

Parameter	Description	Test Conditions	Min	Max	Unit
V _{IL}	Input LOW Voltage ^[1]			0.8	V
V _{IH}	Input HIGH Voltage ^[1]		2.0		V
I _{IL}	Input LOW Current	V _{IN} = 0V		50.0	μA
I _{IH}	Input HIGH Current	V _{IN} = V _{DD}		100.0	μA
V _{OL}	Output LOW Voltage ^[2]	I _{OL} = 8 mA		0.4	V
V _{OH}	Output HIGH Voltage ^[2]	I _{OH} = -8 mA	2.4		V
I _{DD}	Supply Current	Unloaded outputs at 66.66 MHz		32	mA

Notes

1. BUF_IN input has a threshold voltage of V_{DD}/2.
2. Parameter is guaranteed by design and characterization. It is not 100% tested in production.

Switching Characteristics for Commercial and Industrial Temperature Devices^[3]

Parameter	Name	Description	Min	Typ.	Max	Unit
	Duty Cycle ^[2] = $t_2 \div t_1$	Measured at 1.4V	40.0	50.0	60.0	%
t ₃	Rise Time ^[2]	Measured between 0.8V and 2.0V			1.50	ns
t ₄	Fall Time ^[2]	Measured between 0.8V and 2.0V			1.50	ns
t ₅	Output to Output Skew ^[2]	All outputs equally loaded			250	ps
t ₆	Propagation Delay, BUF_IN Rising Edge to OUTPUT Rising Edge ^[2]	Measured at V _{DD} /2	1	5	9.2	ns

Switching Waveforms

Figure 2. Duty Cycle Timing

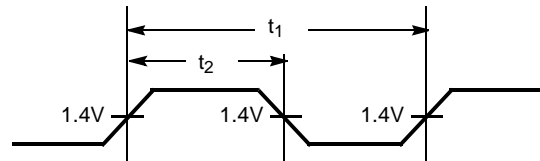

Figure 3. All Outputs Rise/Fall Time

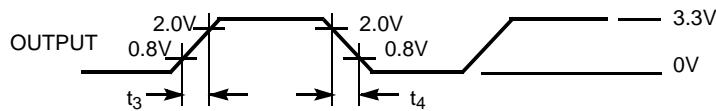

Figure 4. Output-Output Skew

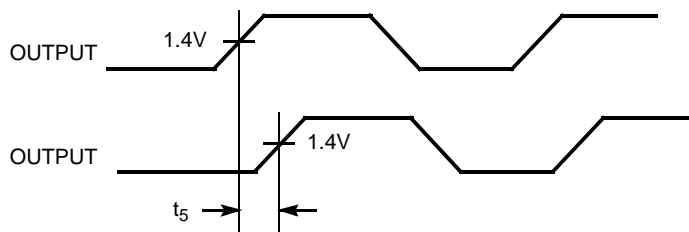
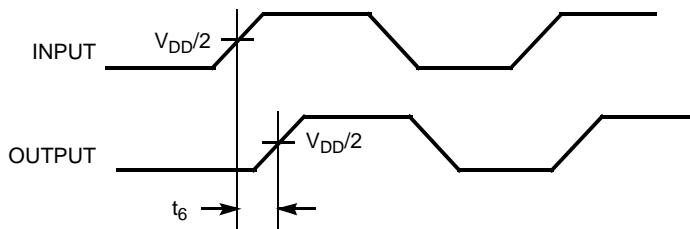

Figure 5. Input-Output Propagation Delay



Note

3. All parameters specified with loaded outputs.

Test Circuits

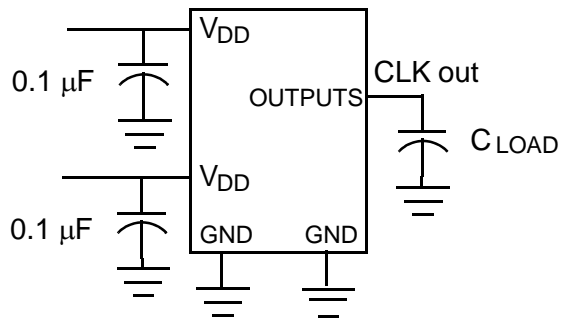

Ordering Information

Ordering Code	Package Type	Operating Range
CY2309NZSC-1H ^[4]	16-pin 150-mil SOIC	Commercial
CY2309NZSC-1HT ^[4]	16-pin 150-mil SOIC – Tape and Reel	Commercial
Pb-free		
CY2309NZSXC-1H	16-pin 150-mil SOIC	Commercial
CY2309NZSXC-1HT	16-pin 150-mil SOIC – Tape and Reel	Commercial
CY2309NZSXI-1H	16-pin 150-mil SOIC	Industrial
CY2309NZSXI-1HT	16-pin 150-mil SOIC – Tape and Reel	Industrial

Package Diagram

Figure 6. 16-Pin (150-Mil) SOIC S16

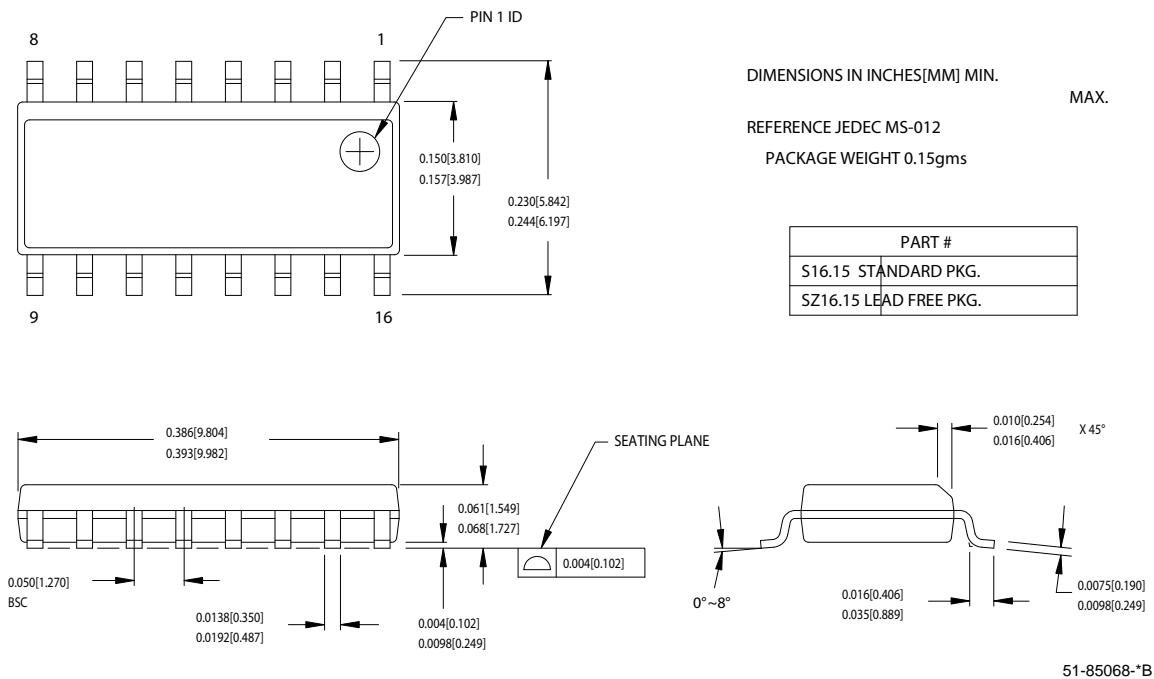

Note
4. Not recommended for new designs.

Document History Page

Document Title: CY2309NZ Nine-Output 3.3V Buffer				
Document Number: 38-07182				
REV.	ECN	Orig. of Change	Submission Date	Description of Change
**	111858	DSG	12/09/01	Change from Spec number: 38-00709 to 38-07182
*A	121834	RBI	12/14/02	Power-up requirements added to Operating Conditions Information
*B	130563	SDR	10/23/03	Added industrial operating temperature to operating conditions
*C	212991	RGL/GGK	03/30/04	Updated the propagation delay T_6 spec to 9.2 ns in the Switching Characteristics table
*D	270149	RGL	10/04/04	Added Lead-free devices Replaced 8.7ns Input/Output Delay to 1ns Input/Output Delay in the features section
*E	2568533	AESA	09/23/08	Updated template. Added Note "Not recommended for new designs." Changed "SDRAM [1:9]" to "OUTPUT [1:9]" in Operating Conditions table. Removed part number CY2309NZSI-1H and CY2309NZSI-1HT.

Sales, Solutions, and Legal Information

Worldwide Sales and Design Support

Cypress maintains a worldwide network of offices, solution centers, manufacturer's representatives, and distributors. To find the office closest to you, visit us at cypress.com/sales.

Products

PSoC	psoc.cypress.com
Clocks & Buffers	clocks.cypress.com
Wireless	wireless.cypress.com
Memories	memory.cypress.com
Image Sensors	image.cypress.com

PSoC Solutions

General	psoc.cypress.com/solutions
Low Power/Low Voltage	psoc.cypress.com/low-power
Precision Analog	psoc.cypress.com/precision-analog
LCD Drive	psoc.cypress.com/lcd-drive
CAN 2.0b	psoc.cypress.com/can
USB	psoc.cypress.com/usb

© Cypress Semiconductor Corporation, 2001-2008. The information contained herein is subject to change without notice. Cypress Semiconductor Corporation assumes no responsibility for the use of any circuitry other than circuitry embodied in a Cypress product. Nor does it convey or imply any license under patent or other rights. Cypress products are not warranted nor intended to be used for medical, life support, life saving, critical control or safety applications, unless pursuant to an express written agreement with Cypress. Furthermore, Cypress does not authorize its products for use as critical components in life-support systems where a malfunction or failure may reasonably be expected to result in significant injury to the user. The inclusion of Cypress products in life-support systems application implies that the manufacturer assumes all risk of such use and in doing so indemnifies Cypress against all charges.

Any Source Code (software and/or firmware) is owned by Cypress Semiconductor Corporation (Cypress) and is protected by and subject to worldwide patent protection (United States and foreign), United States copyright laws and international treaty provisions. Cypress hereby grants to licensee a personal, non-exclusive, non-transferable license to copy, use, modify, create derivative works of, and compile the Cypress Source Code and derivative works for the sole purpose of creating custom software and or firmware in support of licensee product to be used only in conjunction with a Cypress integrated circuit as specified in the applicable agreement. Any reproduction, modification, translation, compilation, or representation of this Source Code except as specified above is prohibited without the express written permission of Cypress.

Disclaimer: CYPRESS MAKES NO WARRANTY OF ANY KIND, EXPRESS OR IMPLIED, WITH REGARD TO THIS MATERIAL, INCLUDING, BUT NOT LIMITED TO, THE IMPLIED WARRANTIES OF MERCHANTABILITY AND FITNESS FOR A PARTICULAR PURPOSE. Cypress reserves the right to make changes without further notice to the materials described herein. Cypress does not assume any liability arising out of the application or use of any product or circuit described herein. Cypress does not authorize its products for use as critical components in life-support systems where a malfunction or failure may reasonably be expected to result in significant injury to the user. The inclusion of Cypress' product in a life-support systems application implies that the manufacturer assumes all risk of such use and in doing so indemnifies Cypress against all charges.

Use may be limited by and subject to the applicable Cypress software license agreement.



**Стандарт
Электрон
Связь**

Мы молодая и активно развивающаяся компания в области поставок электронных компонентов. Мы поставляем электронные компоненты отечественного и импортного производства напрямую от производителей и с крупнейших складов мира.

Благодаря сотрудничеству с мировыми поставщиками мы осуществляем комплексные и плановые поставки широчайшего спектра электронных компонентов.

Собственная эффективная логистика и склад в обеспечивает надежную поставку продукции в точно указанные сроки по всей России.

Мы осуществляем техническую поддержку нашим клиентам и предпродажную проверку качества продукции. На все поставляемые продукты мы предоставляем гарантию .

Осуществляем поставки продукции под контролем ВП МО РФ на предприятия военно-промышленного комплекса России , а также работаем в рамках 275 ФЗ с открытием отдельных счетов в уполномоченном банке. Система менеджмента качества компании соответствует требованиям ГОСТ ISO 9001.

Минимальные сроки поставки, гибкие цены, неограниченный ассортимент и индивидуальный подход к клиентам являются основой для выстраивания долгосрочного и эффективного сотрудничества с предприятиями радиоэлектронной промышленности, предприятиями ВПК и научно-исследовательскими институтами России.

С нами вы становитесь еще успешнее!

Наши контакты:

Телефон: +7 812 627 14 35

Электронная почта: sales@st-electron.ru

Адрес: 198099, Санкт-Петербург,
Промышленная ул, дом № 19, литера Н,
помещение 100-Н Офис 331