

## 2A, 40V - 60V Schottky Bridge Rectifiers

### FEATURES

- Schottky technology
- Ideal for automated placement
- High surge current capability
- Compliant to RoHS Directive 2011/65/EU and in accordance to WEEE 2002/96/EC
- Halogen-free according to IEC 61249-2-21 definition



ABS



### TYPICAL APPLICATION

- General purpose use in ac-to-dc bridge full wave rectification for LED bulb , also suitable for telecommunication

### MECHANICAL DATA

**Case:** Molded plastic body

Molding compound, UL flammability classification rating 94V-0

Moisture sensitivity level: level 1, per J-STD-020

Part no. with suffix "H" means AEC-Q101 qualified

Packing code with suffix "G" means green compound (halogen-free)

**Terminal:** Matte tin plated leads, solderable per JESD22-B102

Meet JESD 201 class 2 whisker test

**Polarity:** Polarity as marked on the body

**Weight:** 0.09g (approximately)

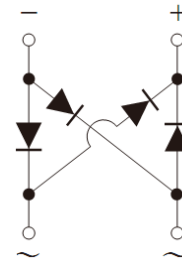
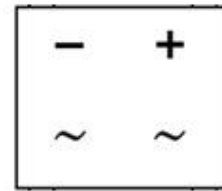

MAXIMUM RATINGS AND ELECTRICAL CHARACTERISTICS (T <sub>A</sub> =25°C unless otherwise noted)					
PARAMETER	SYMBOL	SBS24	SBS25	SBS26	UNIT
Maximum repetitive peak reverse voltage	V <sub>RRM</sub>	40	50	60	V
Maximum RMS voltage	V <sub>RMS</sub>	28	35	42	V
Maximum DC blocking voltage	V <sub>DC</sub>	40	50	60	V
Maximum average forward rectified current	I <sub>F(AV)</sub>	2			A
Peak forward surge current, 8.3 ms single half sine-wave superimposed on rated load	I <sub>FSM</sub>	50			A
Rating for fusing (t<8.3ms)	I <sup>2</sup> t	10.3			A <sup>2</sup> s
Maximum instantaneous forward voltage (Note 1) I <sub>F</sub> = 2 A	V <sub>F</sub>	0.50		0.70	V
Maximum DC reverse current at rated DC blocking voltage (Note 2)	I <sub>R</sub>	100		50	μA
Typical thermal resistance	R <sub>θJL</sub> R <sub>θJA</sub>	30 75			°C/W
Operating junction temperature range (Note 3)	T <sub>J</sub>	- 55 to +150			°C
Storage temperature range	T <sub>STG</sub>	- 55 to +150			°C

Note 1: Pulse test with PW=300 μs, 1% duty cycle

Note 2: Pulse test with PW=40ms

Note 3:  $\frac{dP_{tot}}{dT_j} < \frac{1}{R_{th(j-a)}}$  Condition to avoid thermal runaway based on the application thermal conduction, δ=0.5

ORDERING INFORMATION					
PART NO.	PART NO. SUFFIX	PACKING CODE	PACKING CODE SUFFIX	PACKAGE	PACKING
SBS2x (Note 1, 2)	H	RE	G	ABS	1,000 / 7" Plastic reel
		RG		ABS	5,000 / 13" Paper reel

Note 1: "x" defines voltage from 40V (SBS24) to 60V (SBS26)

Note 2: Whole series with green compound

EXAMPLE					
PREFERRED P/N	PART NO.	PART NO. SUFFIX	PACKING CODE	PACKING CODE SUFFIX	DESCRIPTION
SBS24HREG	SBS24	H	RE	G	AEC-Q101 qualified Green compound

**RATINGS AND CHARACTERISTICS CURVES**

( $T_A=25^{\circ}\text{C}$  unless otherwise noted)

FIG. 1 MAXIMUM FORWARD CURRENT DERATING CURVE

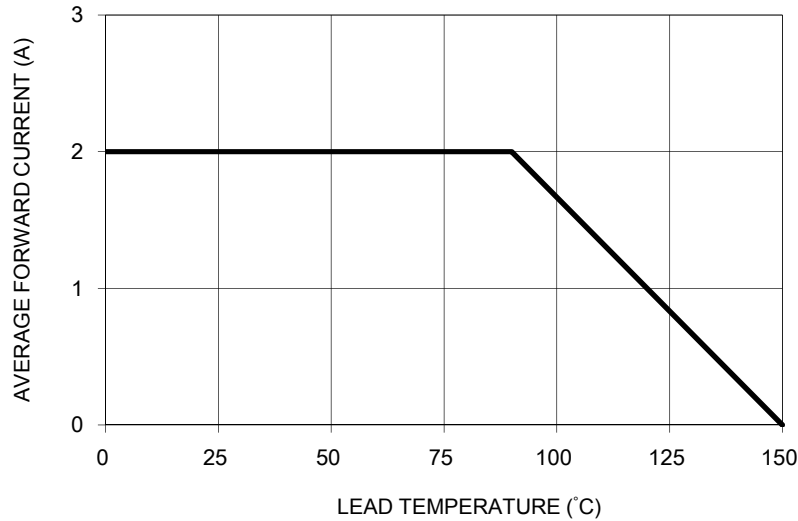

FIG. 2 TYPICAL REVERSE CHARACTERISTICS

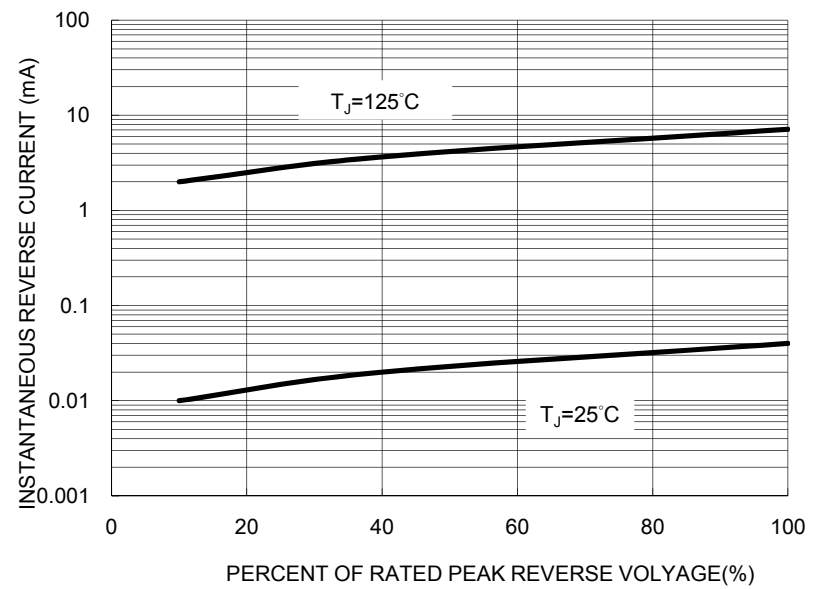

FIG. 3 MAXIMUM NON-REPETITIVE FORWARD SURGE CURRENT

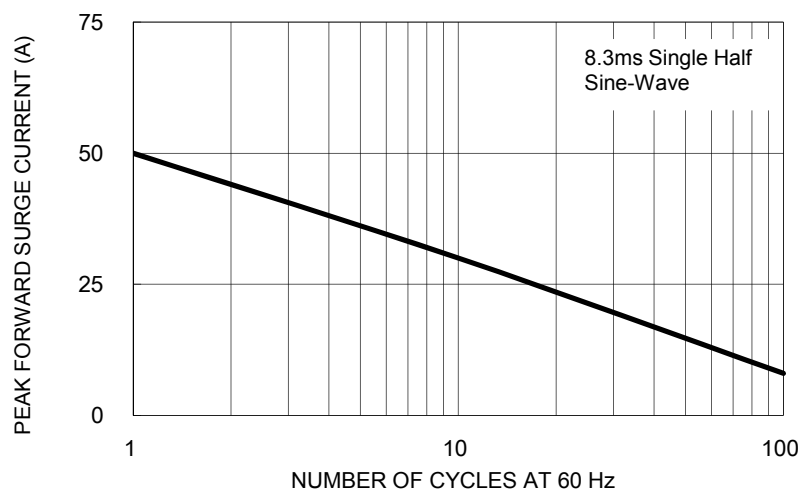

FIG. 4 TYPICAL JUNCTION CAPACITANCE

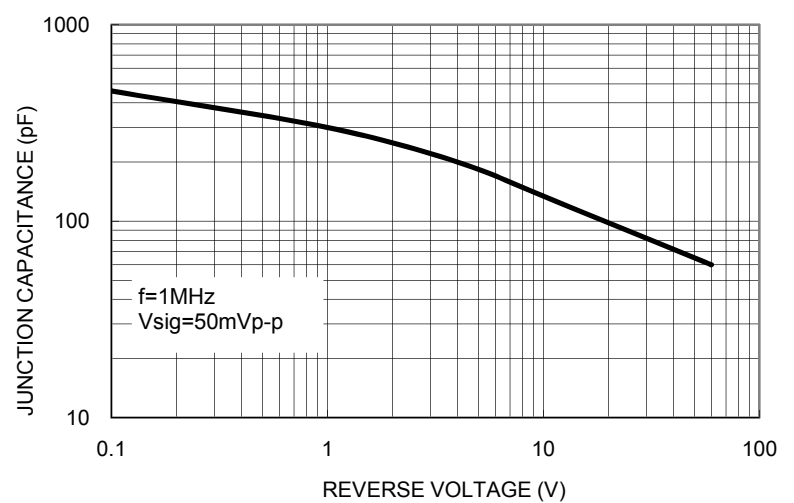
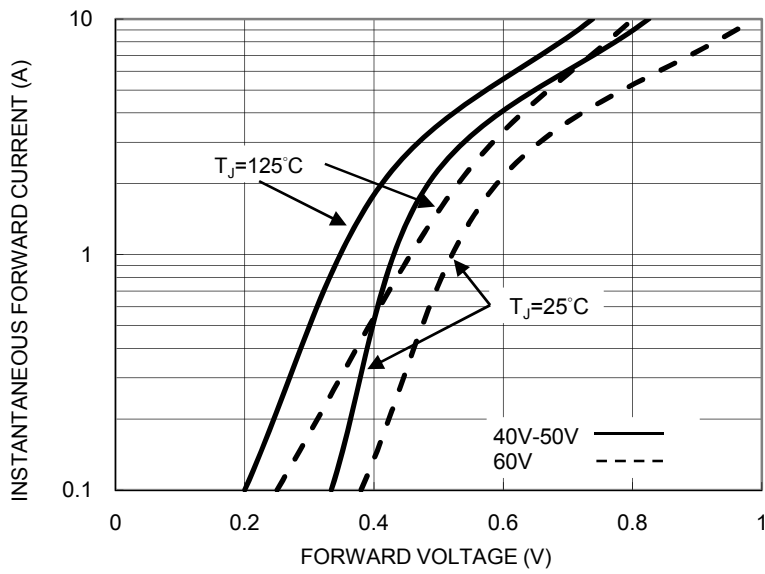
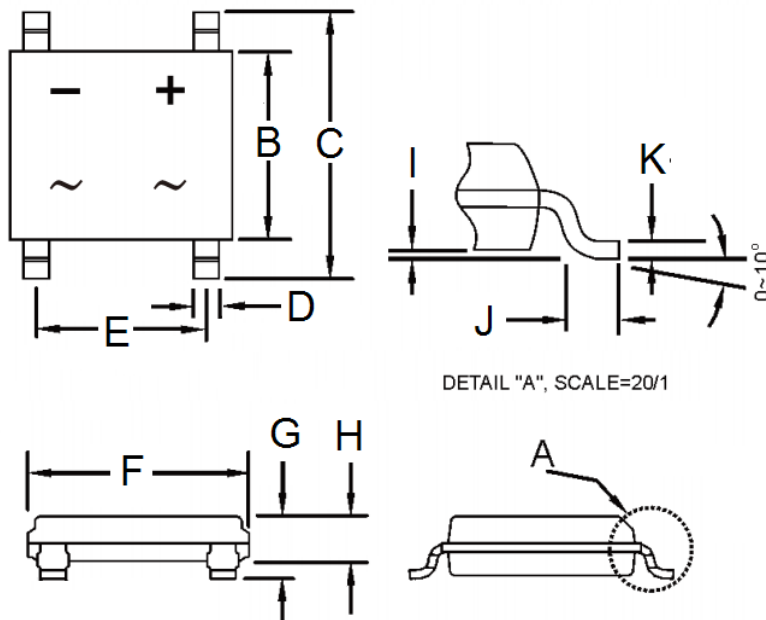

FIG. 5 TYPICAL FORWARD CHARACTERISTICS



PACKAGE OUTLINE DIMENSIONS

ABS



DIM.	Unit (mm)		Unit (inch)	
	Min	Max	Min	Max
B	4.30	4.50	0.169	0.177
C	6.25	6.65	0.246	0.262
D	0.60	0.70	0.024	0.028
E	3.90	4.10	0.154	0.161
F	4.90	5.10	0.193	0.200
G	1.40	1.60	0.055	0.063
H	1.35	1.45	0.053	0.057
I	0.05	0.15	0.002	0.006
J	0.30	0.70	0.012	0.028
K	0.15	0.25	0.006	0.010

SUGGESTED PAD LAYOUT

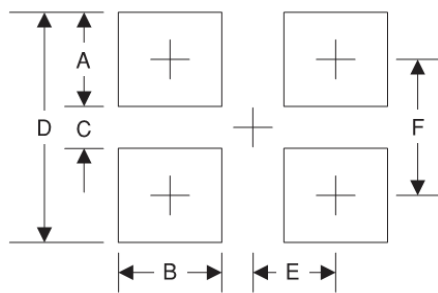

Symbol	Unit (mm)	Unit (inch)
A	1.5	0.059
B	0.9	0.035
C	4.22	0.166
D	7.22	0.284
E	2.05	0.081
F	5.72	0.225

MARKING DIAGRAM



- P/N = Specific Device Code
- YW = Date Code
- F = Factory Code

## Notice

Specifications of the products displayed herein are subject to change without notice. TSC or anyone on its behalf, assumes no responsibility or liability for any errors or inaccuracies.

Information contained herein is intended to provide a product description only. No license, express or implied, to any intellectual property rights is granted by this document. Except as provided in TSC's terms and conditions of sale for such products, TSC assumes no liability whatsoever, and disclaims any express or implied warranty, relating to sale and/or use of TSC products including liability or warranties relating to fitness for a particular purpose, merchantability, or infringement of any patent, copyright, or other intellectual property right.

The products shown herein are not designed for use in medical, life-saving, or life-sustaining applications. Customers using or selling these products for use in such applications do so at their own risk and agree to fully indemnify TSC for any damages resulting from such improper use or sale.



**Стандарт  
Электрон  
Связь**

Мы молодая и активно развивающаяся компания в области поставок электронных компонентов. Мы поставляем электронные компоненты отечественного и импортного производства напрямую от производителей и с крупнейших складов мира.

Благодаря сотрудничеству с мировыми поставщиками мы осуществляем комплексные и плановые поставки широчайшего спектра электронных компонентов.

Собственная эффективная логистика и склад в обеспечивает надежную поставку продукции в точно указанные сроки по всей России.

Мы осуществляем техническую поддержку нашим клиентам и предпродажную проверку качества продукции. На все поставляемые продукты мы предоставляем гарантию .

Осуществляем поставки продукции под контролем ВП МО РФ на предприятия военно-промышленного комплекса России , а также работаем в рамках 275 ФЗ с открытием отдельных счетов в уполномоченном банке. Система менеджмента качества компании соответствует требованиям ГОСТ ISO 9001.

Минимальные сроки поставки, гибкие цены, неограниченный ассортимент и индивидуальный подход к клиентам являются основой для выстраивания долгосрочного и эффективного сотрудничества с предприятиями радиоэлектронной промышленности, предприятиями ВПК и научно-исследовательскими институтами России.

С нами вы становитесь еще успешнее!

**Наши контакты:**

**Телефон:** +7 812 627 14 35

**Электронная почта:** [sales@st-electron.ru](mailto:sales@st-electron.ru)

**Адрес:** 198099, Санкт-Петербург,  
Промышленная ул, дом № 19, литера Н,  
помещение 100-Н Офис 331